

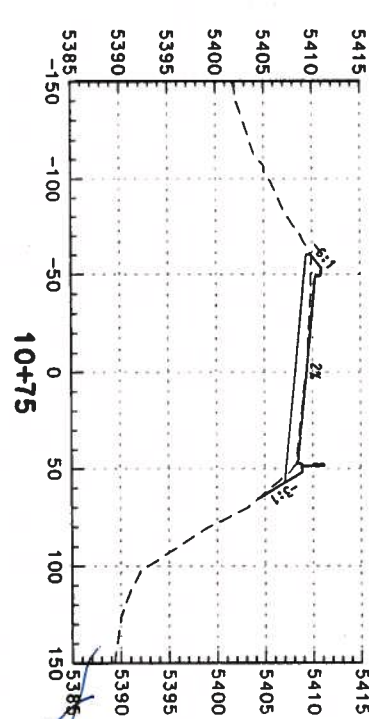

30% Design

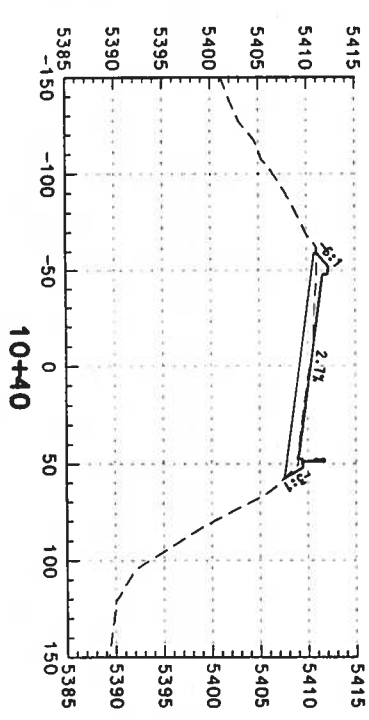

Computer File Information		Index of Revisions		 REGION I 359 Liverness Dr. South Suite K Englewood, CO 80112 Phone: (303) 790-1020 Fax: (303) 790-1037		 5500 Greenwood Plaza Blvd. Suite 150 Greenwood Village, CO 80111 Phone: 303/221-7275 Fax: 303/221/7276	
Creation Date:	02/14/03	Initials:	DAF				
Lost Modification Date:		Initials:		US 85 CROSS SECTIONS			
Full Path:	S:\Trompro\ 246042\2\HwyDes\Plans\						
Drawing File Name:	rdxs-ro-26001.dgn						
Scale:	Units: ENGLISH			As Constructed No. Revisions: _____ Revised: _____ Void: _____		Designer: DAF Detailer: DAF Sheet Subset: Roadway Subsheet Sheets: _____ of _____	
				Project No./Code NH 0852-086 13429		Sheet Number: 300	

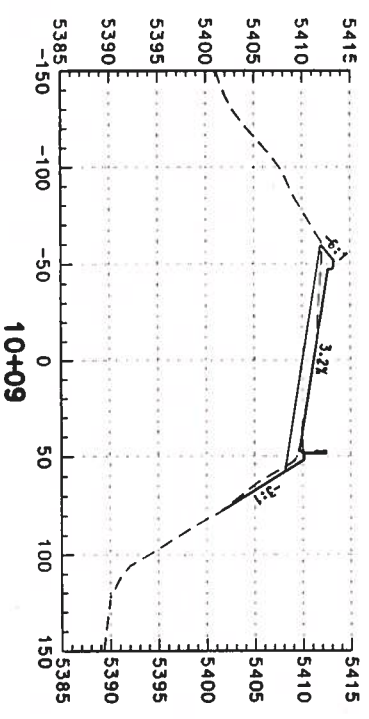
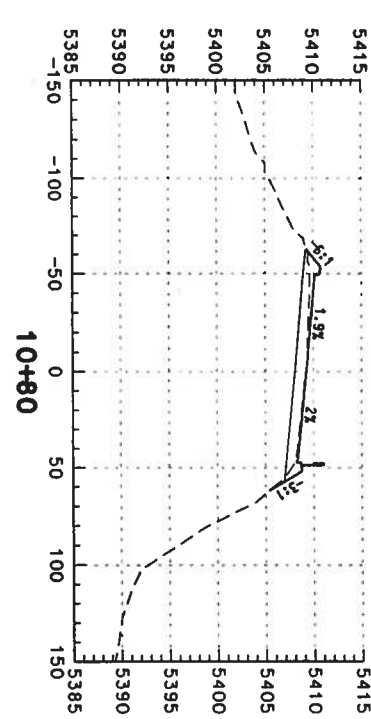
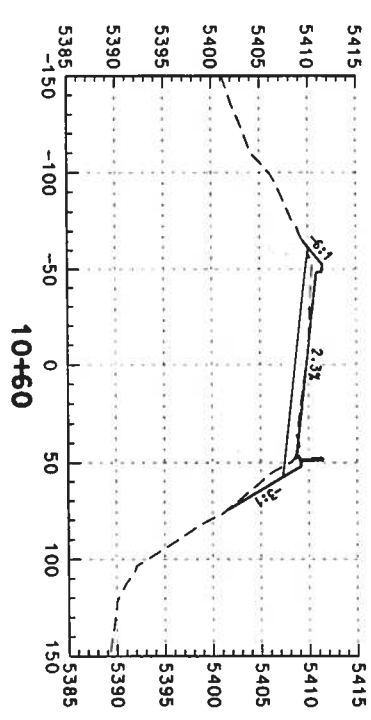
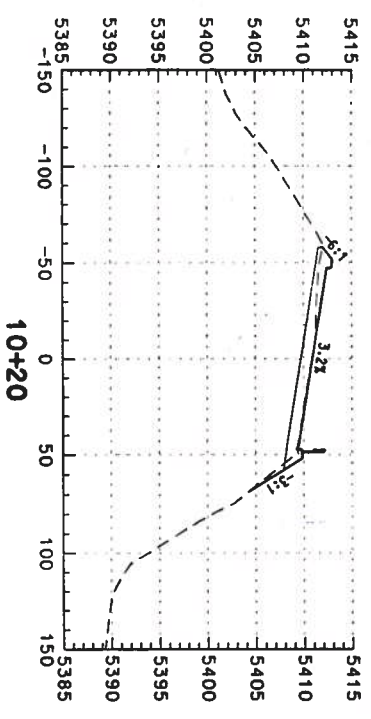
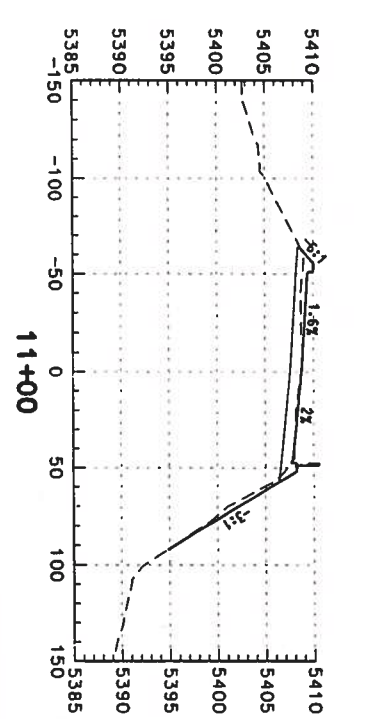
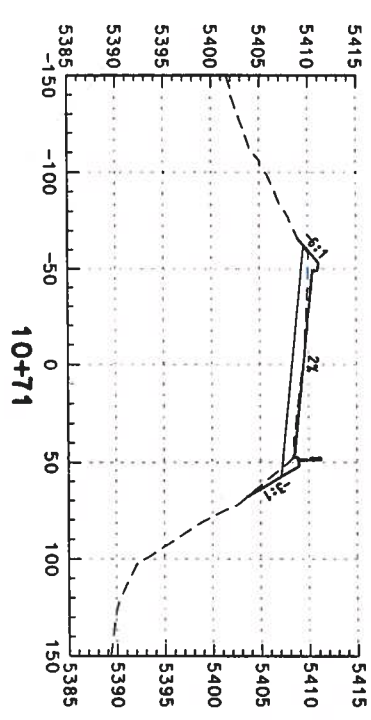
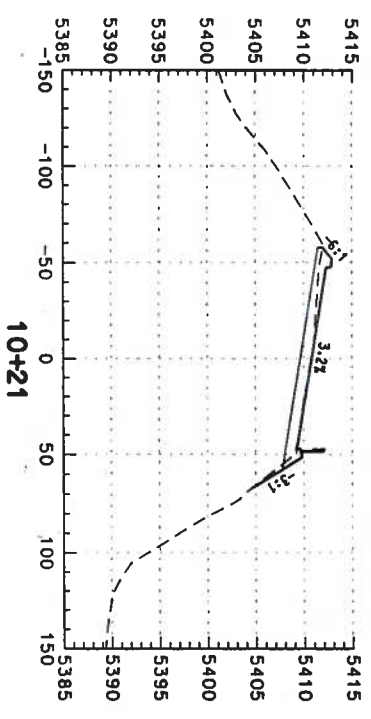

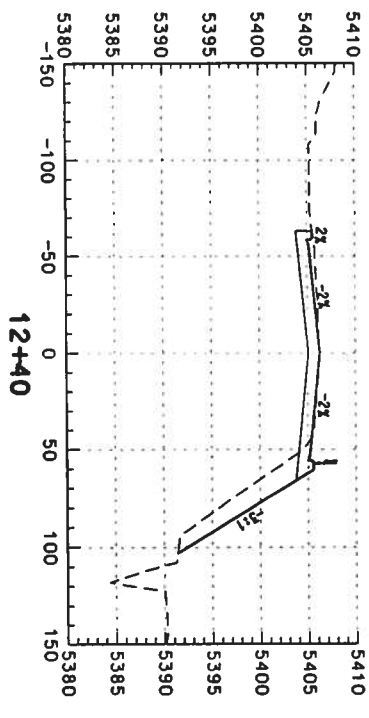
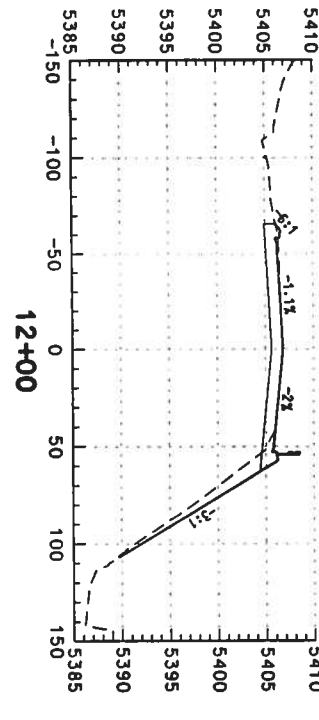
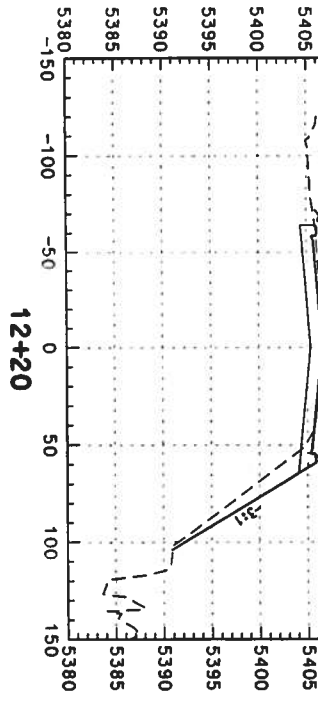
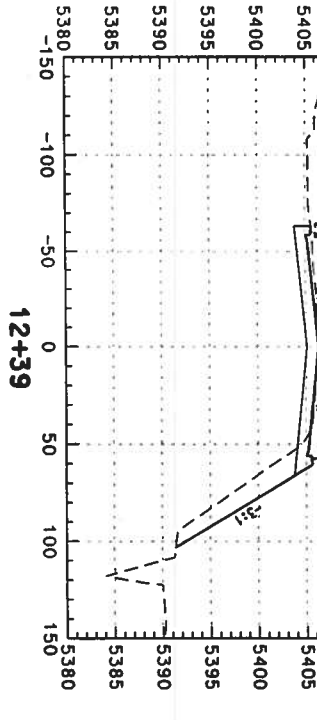
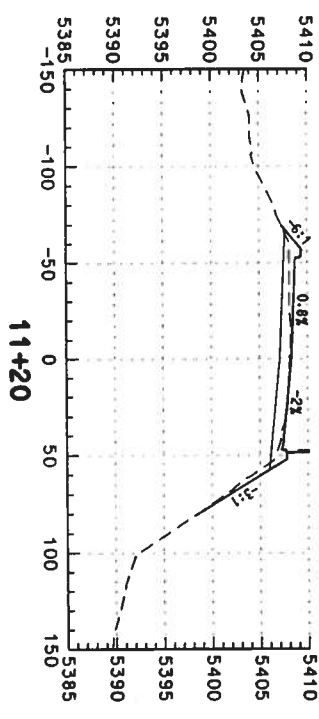
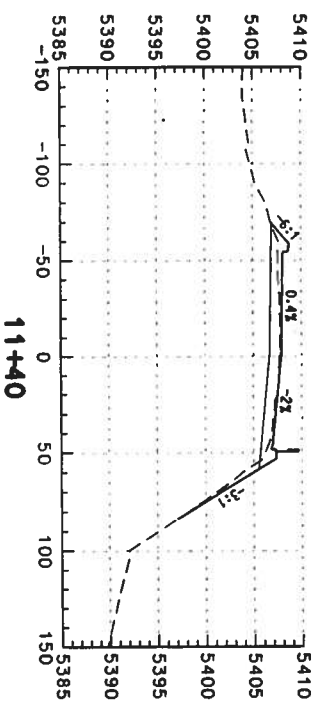
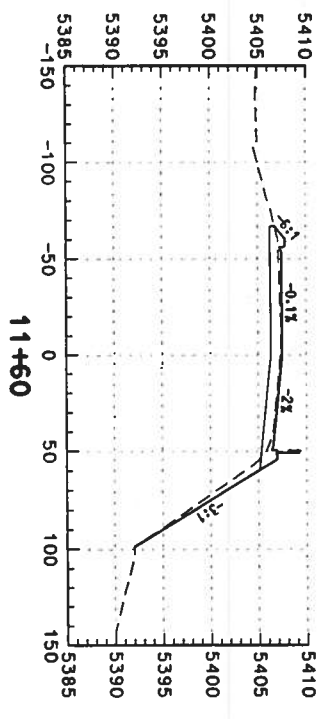
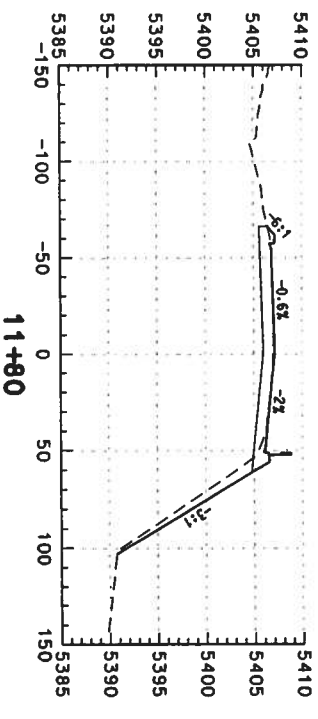
Computer File Information
 Creation Date: 02/14/03 Initials: DAF
 Last Modification Date: Initials:
 Full Path: S:\tramp\proj\246042.12\HwyDes\Plans\
 Drawing File Name: rdxs-no-2d002.dgn
 Scale: Units: ENGLISH

Index of Revisions

DOT
 DEPARTMENT OF TRANSPORTATION
 REGION 1
 359 Inverness Dr. South
 Suite K
 Englewood, CO 80112
 Phone: (303) 790-1020
 FAX: (303) 790-1037

PBSJ
 5500 Greenwood Plaza Blvd.
 Suite 150
 Greenwood Village, CO 80111
 Phone: 303/221-7275
 Fax: 303/221/7276

As Constructed
 No. Revisions:
 Revised:
 Void:

US 85 CROSS SECTIONS
 Designer: DAF
 Detailer: DAF
 Sheet Subset: Roadway
 Subset Sheets: of

Project No./Code
 NH 0852-086
 13429
 Sheet Number: 301

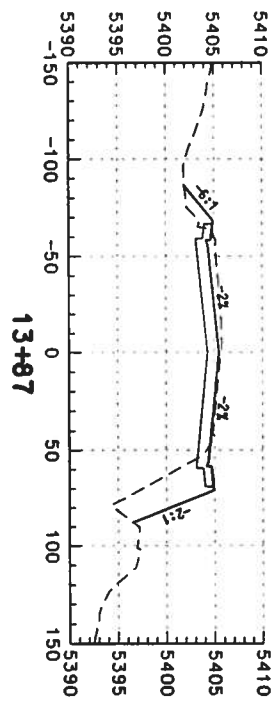
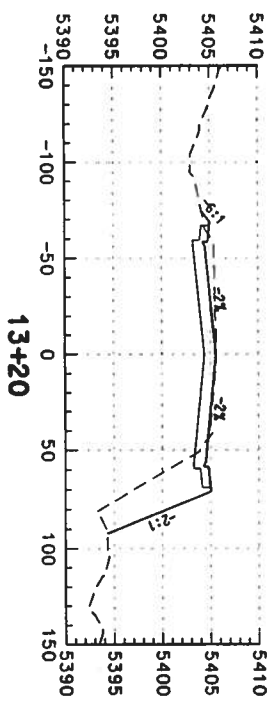
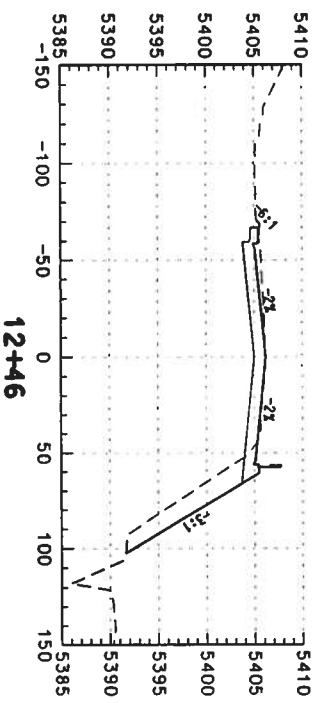
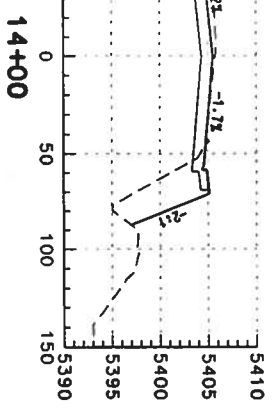
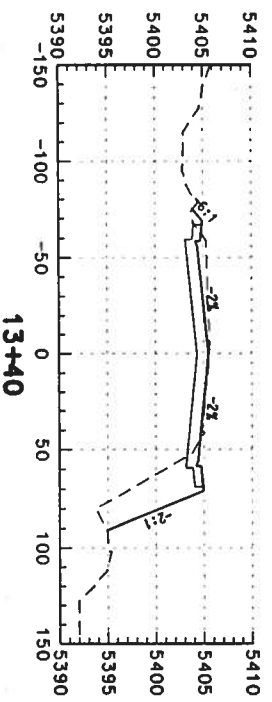
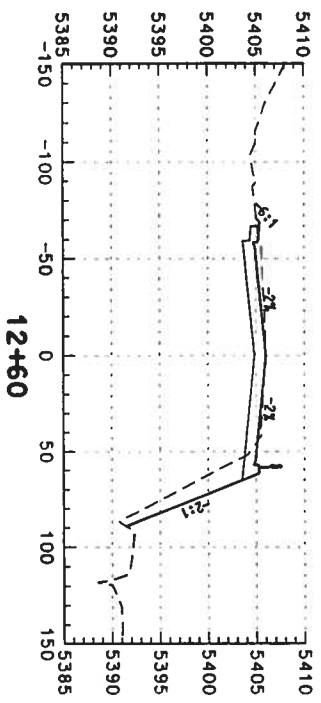
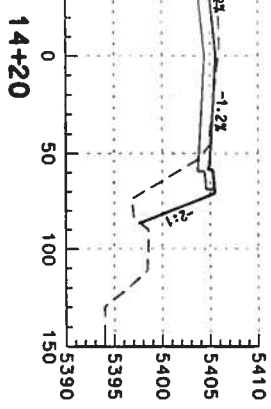
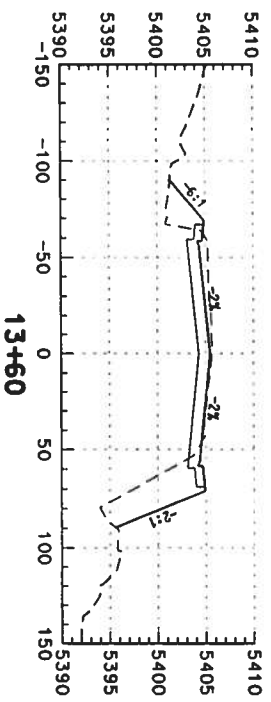
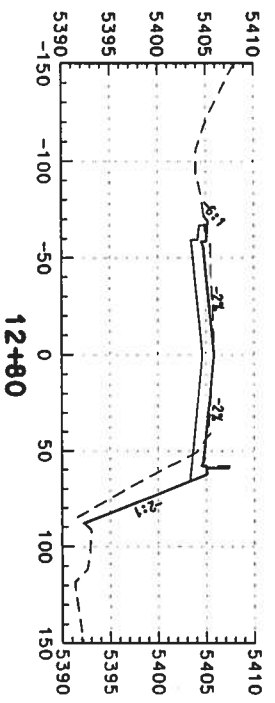
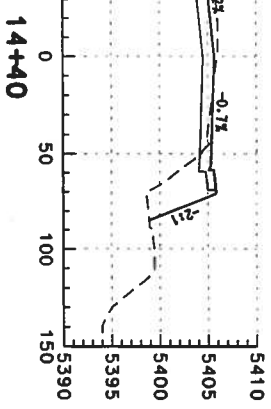
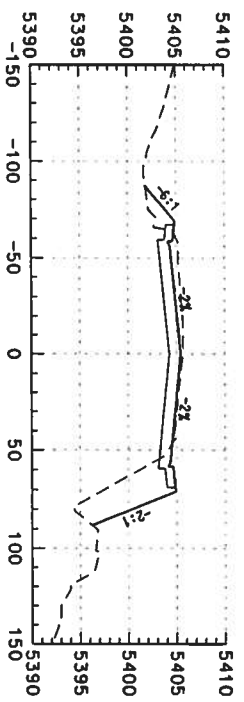
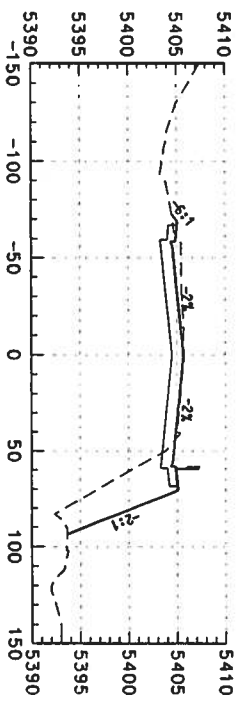

Computer File Information
 Creation Date: 02/14/03 Initials: DAF
 Lost Modification Date: Initials:
 Full Path: S:\IT\proj\246042\246042\HyDes\Plans\
 Drawing File Name: rdxs-no-2d003.dgn
 Scale: Units: ENGLISH

Index of Revisions

DOT
 DEPARTMENT OF TRANSPORTATION
 REGION 1
 359 Inverness Dr. South
 Suite K
 Englewood, CO 80112
 Phone: (303) 790-1020
 Fax: (303) 790-1037

PBSJ
 5500 Greenwood Plaza Blvd.
 Suite 150
 Greenwood Village, CO 80111
 Phone: 303/221-7275
 Fax: 303/221/7276

As Constructed

No. Revisions:	
Revised:	
Void:	

US 85 CROSS SECTIONS

Designer:	DAF	Structure	
Detailer:	DAF	Numbers	
Sheet Subset:	Roadway	Subset Sheets:	of

Project No./Code
 NH 0852-086
 13429
 Sheet Number: 302

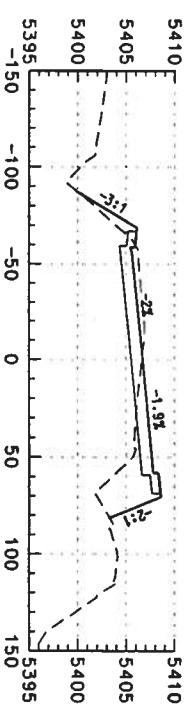

15+40

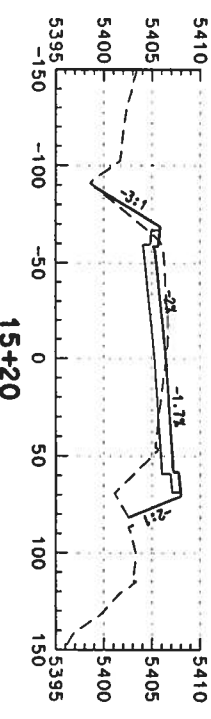

15+20

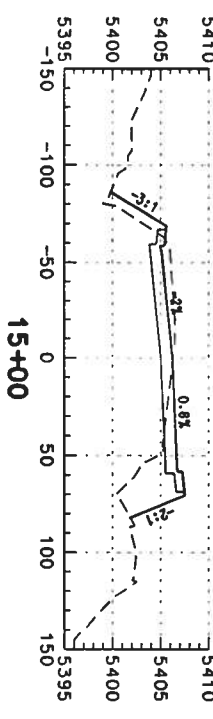

15+00

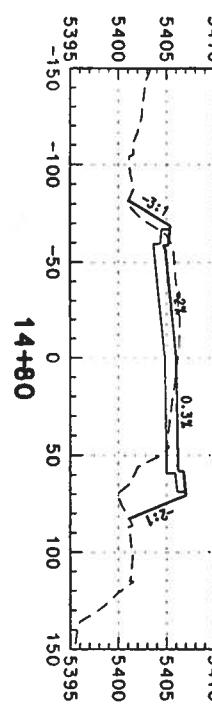

14+80

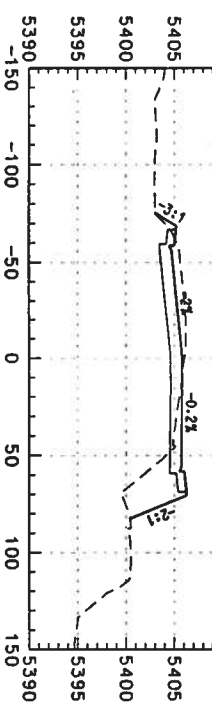

14+60

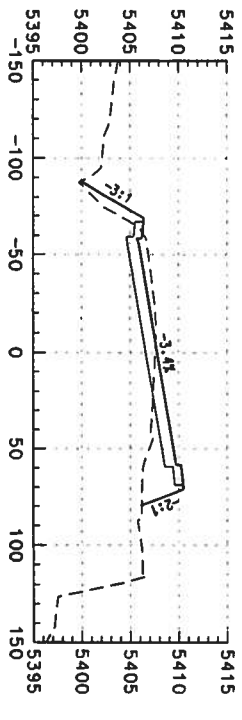

16+00

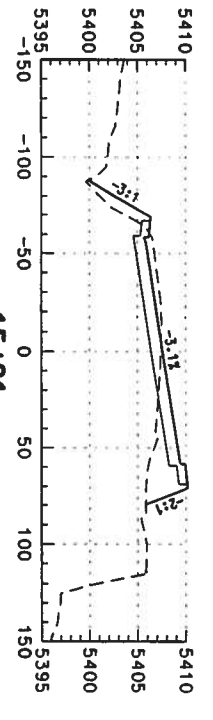

15+91

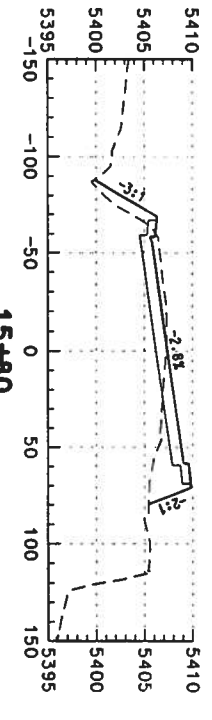

15+80

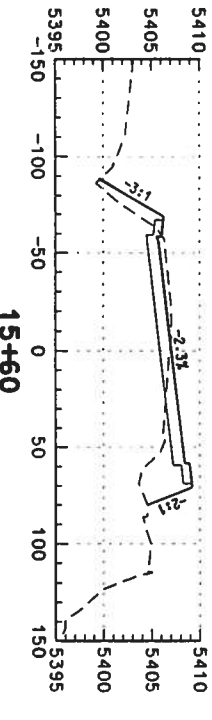

15+60

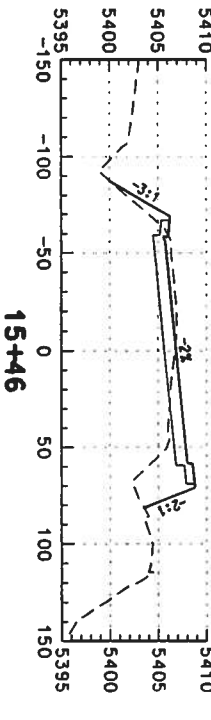

15+46

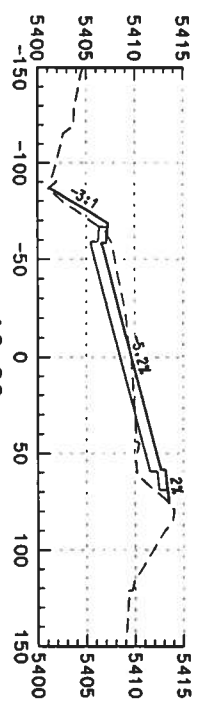

16+80

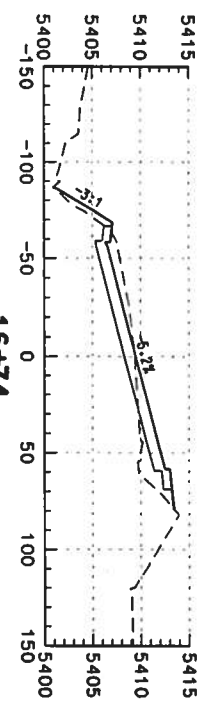

16+74

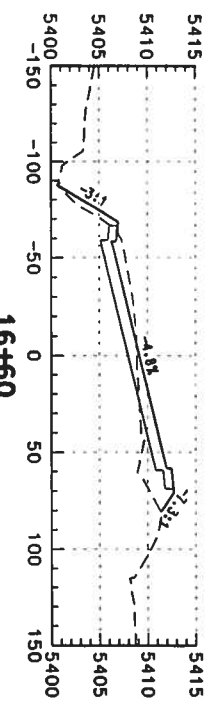

16+60

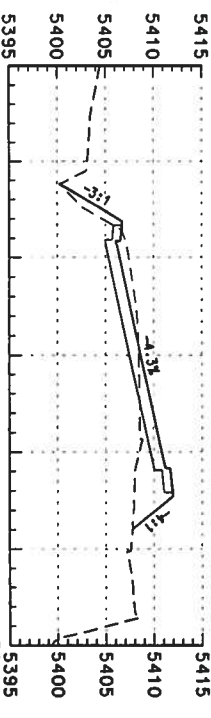

16+40

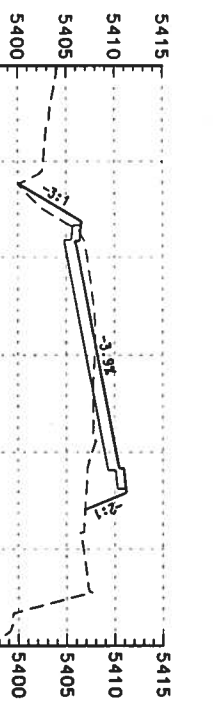

16+20

Computer File Information
 Creation Date: 02/14/03 Initials: DAF
 Last Modification Date: Initials:
 Full Path: S:\Tromproj\246042\2\HyDes\Plans\
 Drawing File Name: rdxs-no-2d004.dgn
 Scale: Units: ENGLISH

Index of Revisions

DOT
 DEPARTMENT OF TRANSPORTATION
 359 Inverness Dr. South
 Suite K
 Englewood, CO 80112
 Phone: (303) 790-1020
 Fax: (303) 790-1037

PBSJ
 5500 Greenwood Plaza Blvd.
 Suite 150
 Greenwood Village, CO 80111
 Phone: 303/221-7275
 Fax: 303/221/7276

As Constructed
 No. Revisions:
 Revised:
 Void:

US 85 CROSS SECTIONS
 Designer: DAF
 Detailer: DAF
 Sheet Subset: Roadway
 Subset Sheets: of

Project No./Code
 NH 0852-086
 Sheet Number: 303

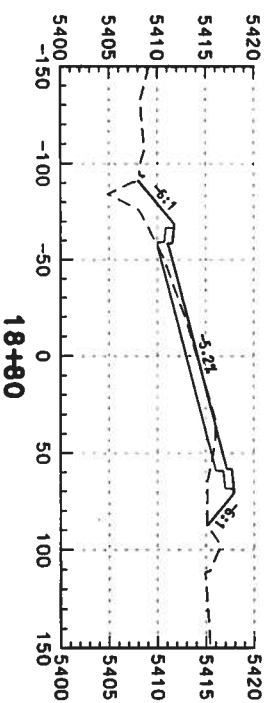
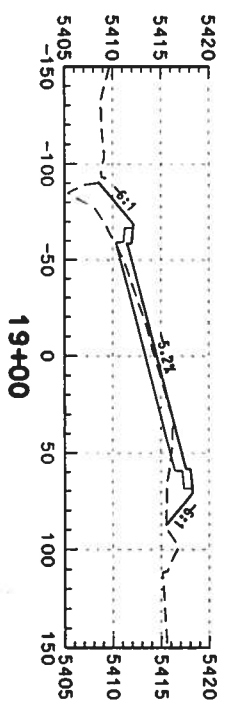
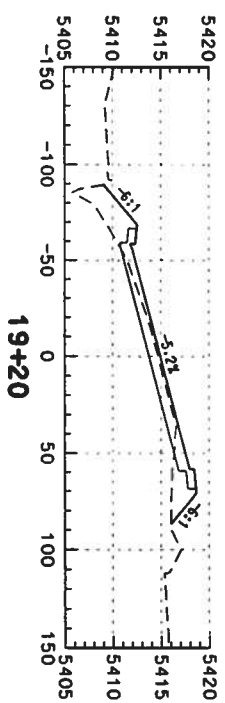
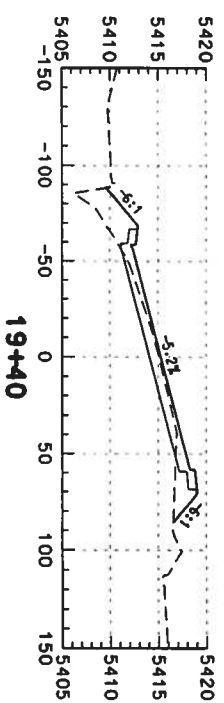
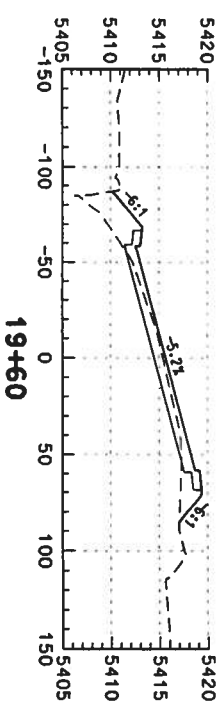
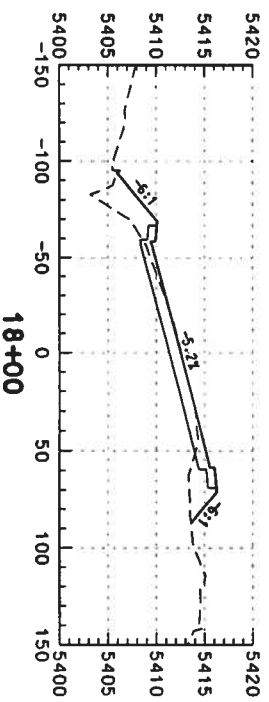
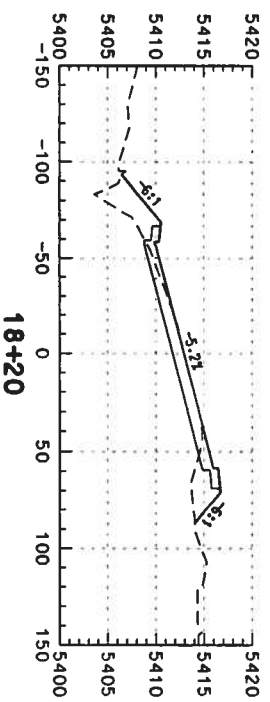
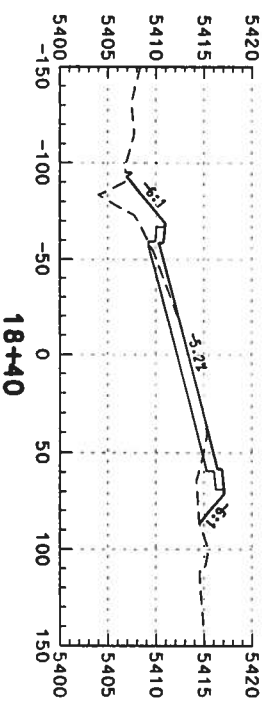
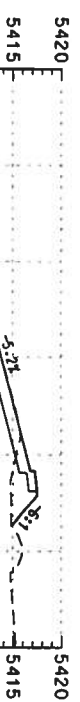
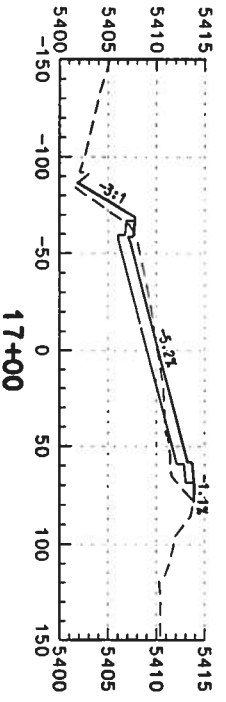
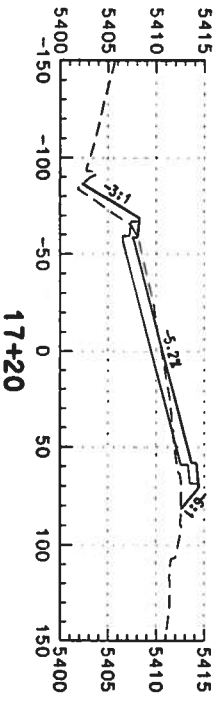
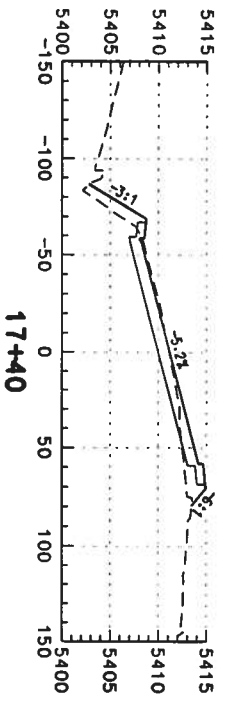
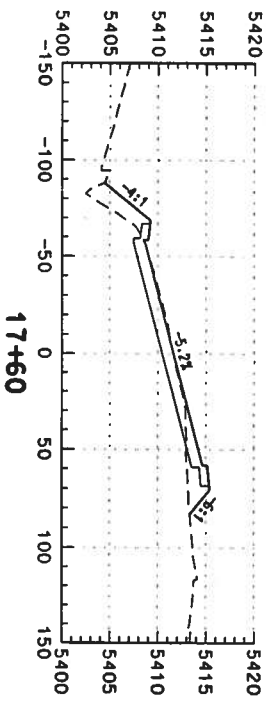
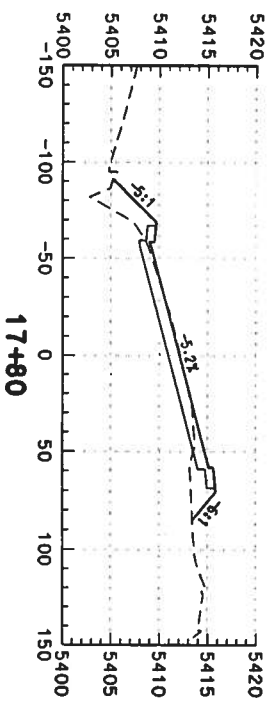

Computer File Information

Creation Date: 02/14/03 Initials: DAF
 Last Modification Date: Initials:
 Full Path: S:\Transport\246042\246042\HwyDes\Plans\
 Drawing File Name: rdxs-no-20005.dgn
 Scale: Units: ENGLISH

Index of Revisions



339 Inverness Dr. South
 Suite K
 Englewood, CO 80112
 Phone: (303) 790-1020
 Fax: (303) 790-1037



5500 Greenwood Plaza Blvd.
 Suite 150
 Greenwood Village, CO 80111
 Phone: 303/721-7275
 Fax: 303/221/7276

As Constructed
 No. Revisions:
 Revised:
 Void:

US 85 CROSS SECTIONS
 Designer: DAF
 Detailer: DAF
 Sheet Subset: Roadway Subset Sheets: of

Project No./Code
 NH 0852-086
 13429
 Sheet Number: 304

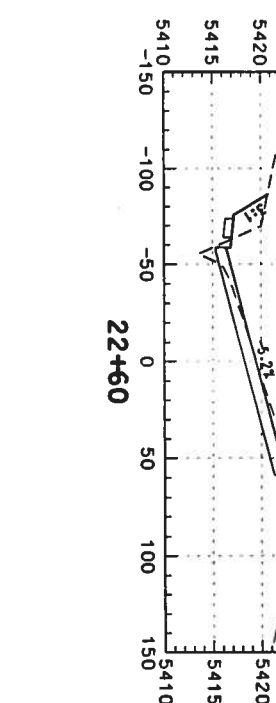
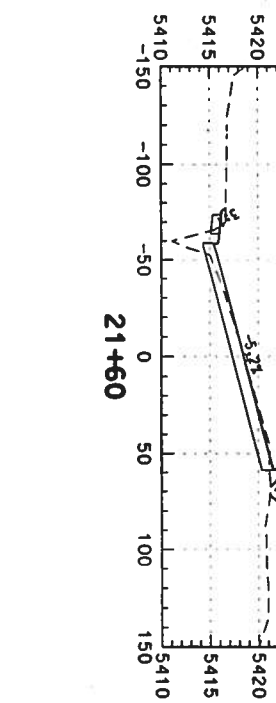
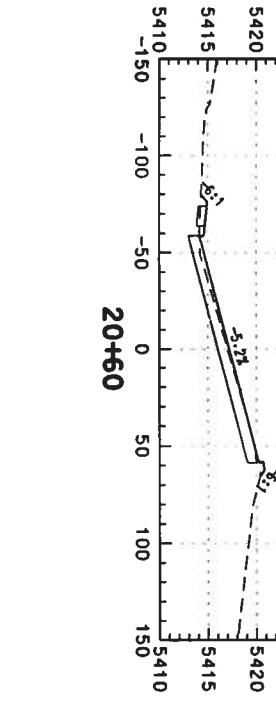
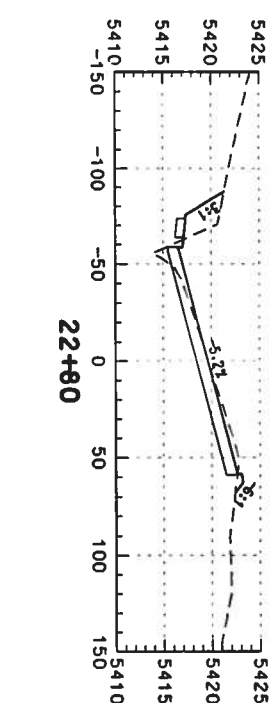
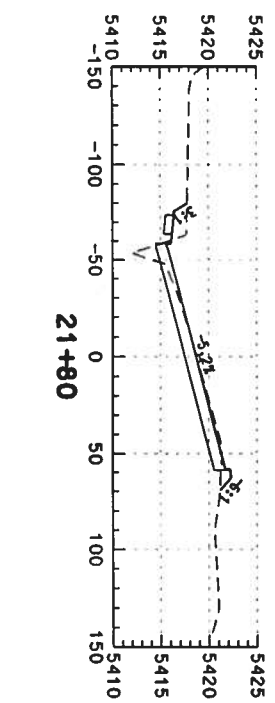
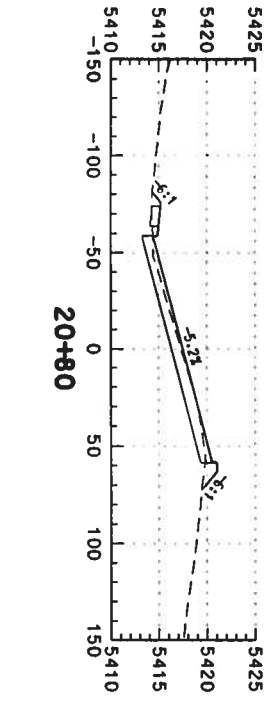
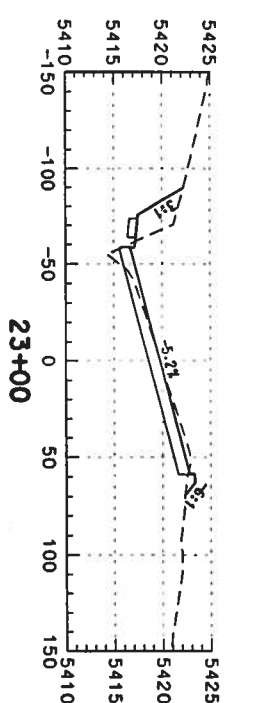
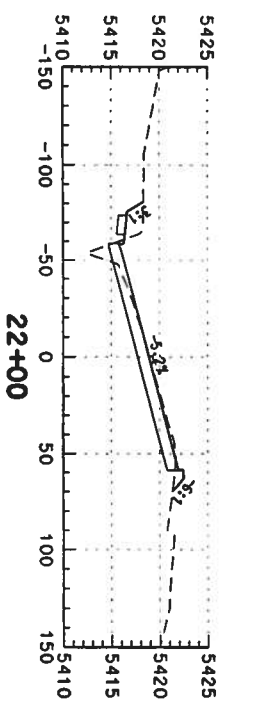
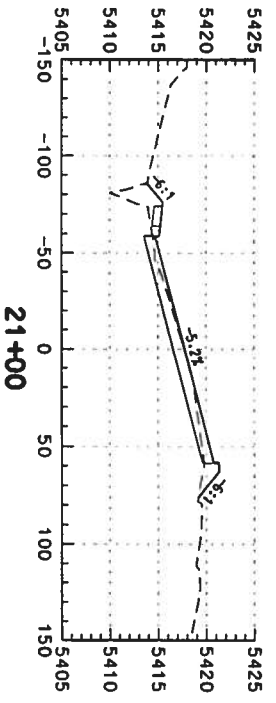
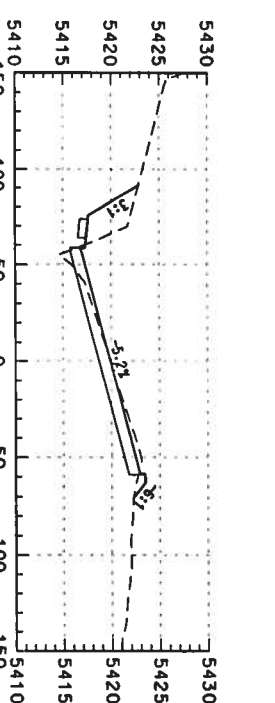
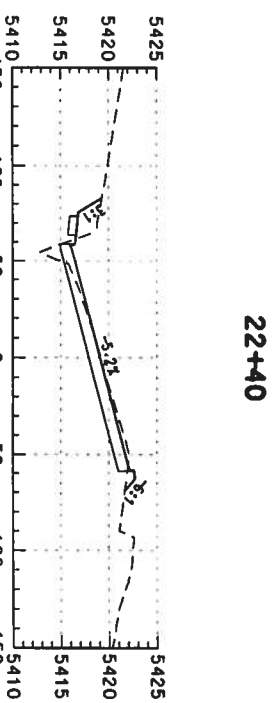
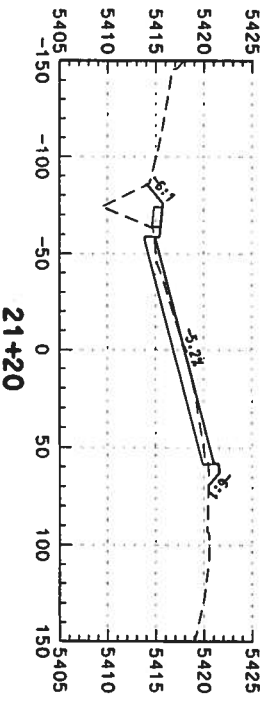
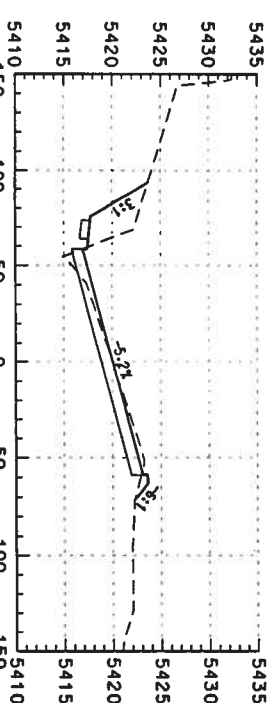
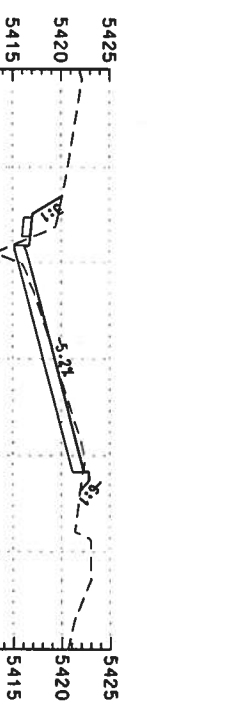
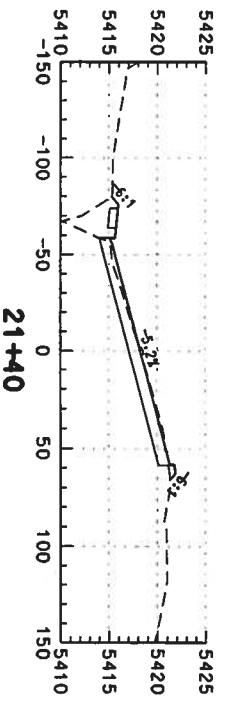

Computer File Information

Creation Date: 02/14/03 Initials: DAF
 Last Modification Date: Initials:
 Full Path: S:\Tranpro\246042.12\HwyDes\Plans\
 Drawing File Name: rdxs-no-2d007.dgn
 Scale: Units: ENGLISH

Index of Revisions

As Constructed

No. Revisions:
 Revised:
 Void:

US 85 CROSS SECTIONS

Designer: DAF
 Detailer: DAF
 Sheet Subset: Roadway
 Subset Sheets: of

Project No./Code

NH 0852-086
 13429
 Sheet Number: 306

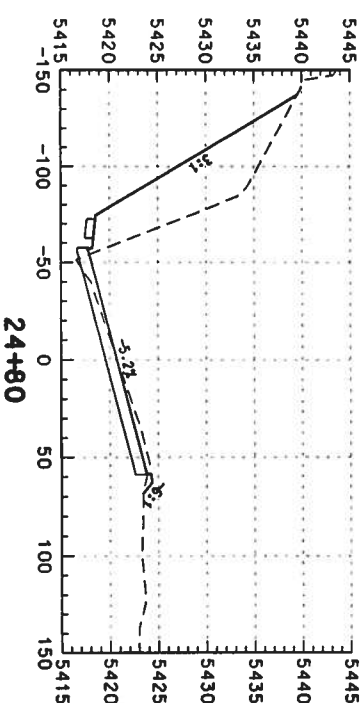
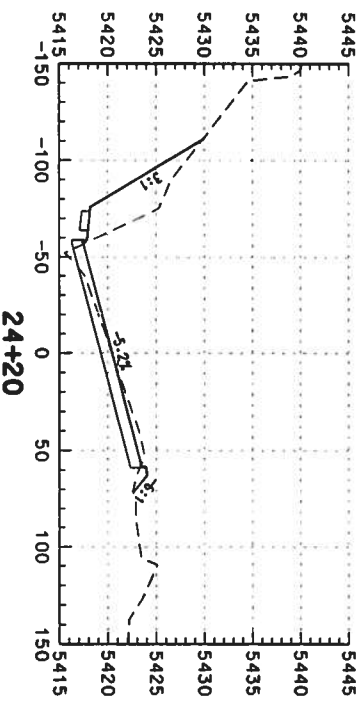
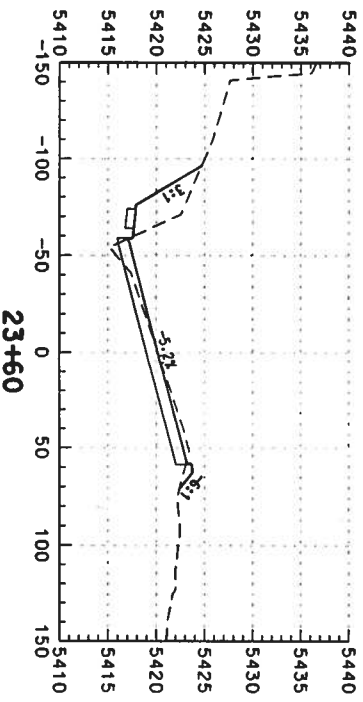
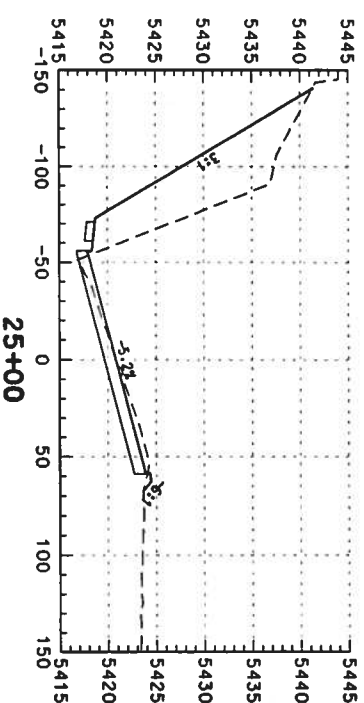
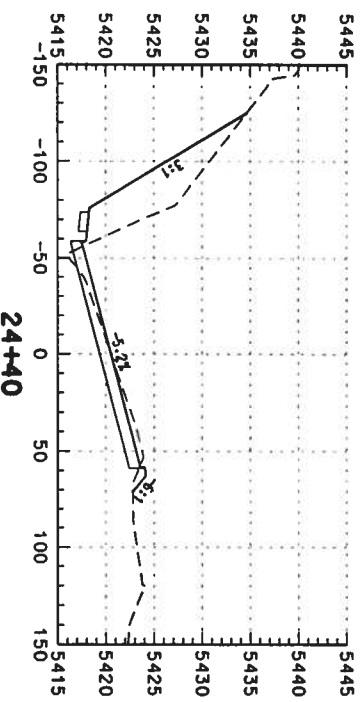
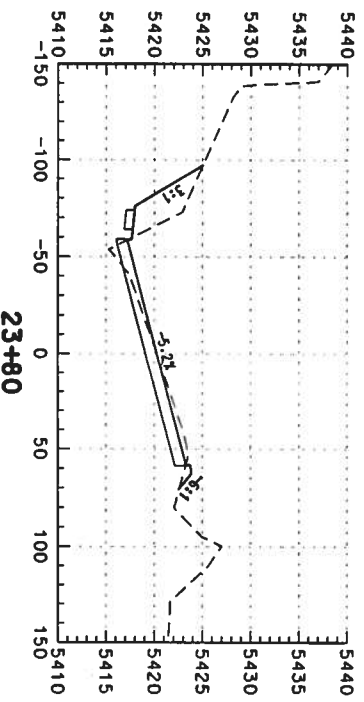
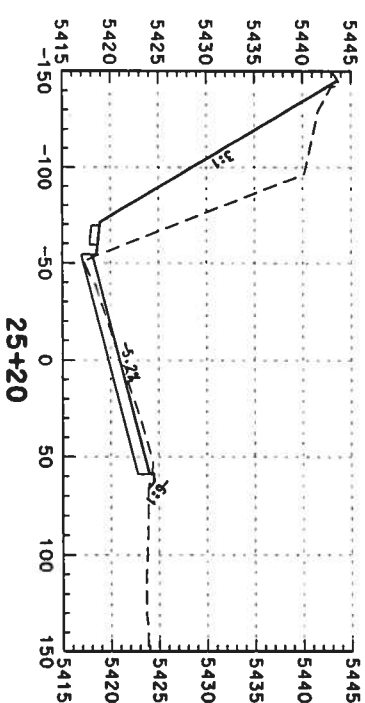
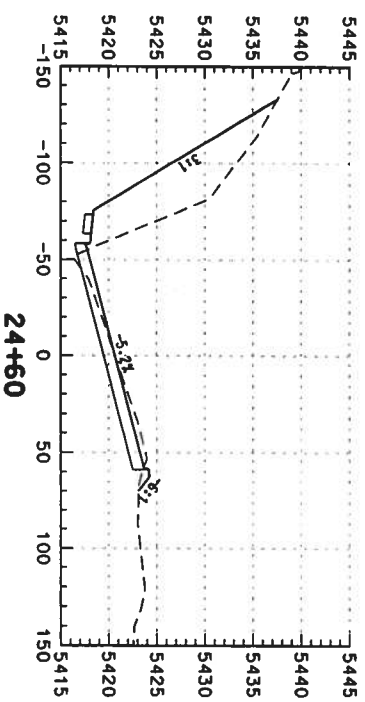
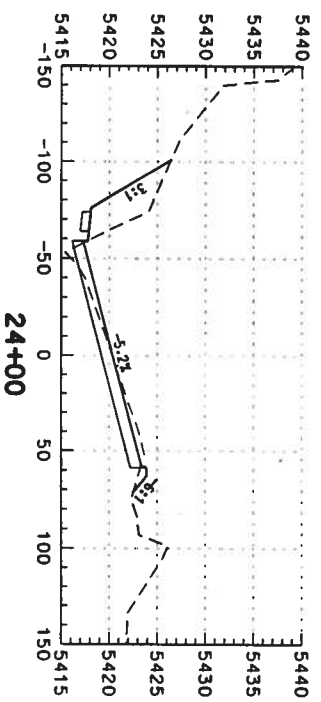

Computer File Information	
Creation Date:	02/14/03
Last Modification Date:	
Full Path:	S:\Transport\246042.12\HyDes\Plans\
Drawing File Name:	rdxs-no-20008.dgn
Scale:	Units: ENGLISH

Index of Revisions	
Initials:	DAF

DOT
 DEPARTMENT OF TRANSPORTATION
 REGION 1
 359 Inverness Dr. South
 Suite K
 Englewood, CO 80112
 Phone: (303) 790-1020
 FAX: (303) 790-1037

PBSJ
 5500 Greenwood Plaza Blvd.
 Suite 150
 Greenwood Village, CO 80111
 Phone: 303/221-7275
 Fax: 303/221/7276

As Constructed	
No. Revisions:	
Revised:	
Void:	

US 85 CROSS SECTIONS	
Designer:	DAF
Detailer:	DAF
Sheet Subset:	Roadway
Structure Numbers:	
Subset Sheets:	
	of

Project No./Code	
NH 0852-086	
13429	
Sheet Number:	307

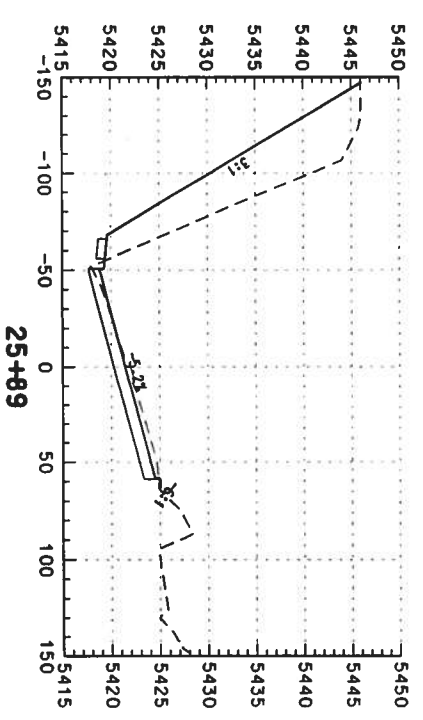
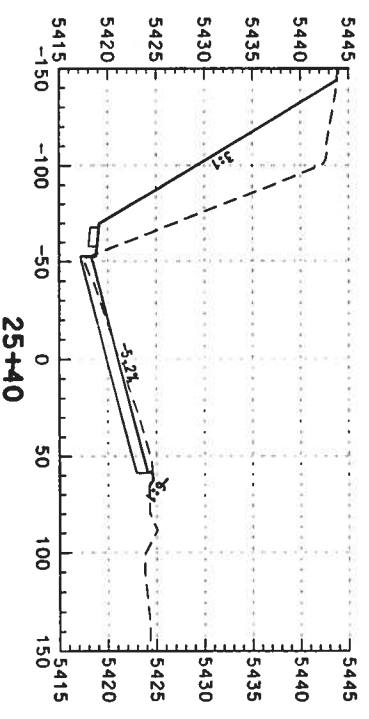
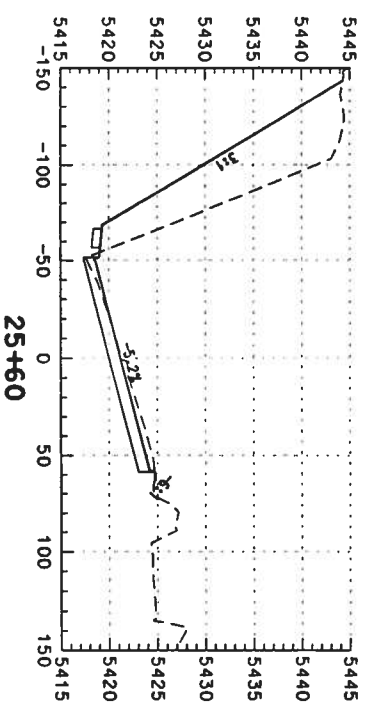
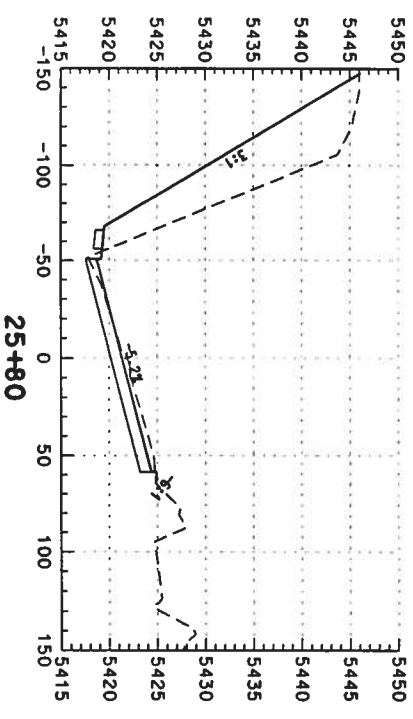

Computer File Information

Creation Date: 02/14/03 Initials: DAF
 Lost Modification Date: Initials:
 Full Path: S:\Tromproj\246042\2\HydDes\Plans\
 Drawing File Name: rdxs-no-2d009.dgn
 Scale: Units: ENGLISH

Index of Revisions



359 Inverness Dr. South
 Suite K
 Englewood, CO 80112
 Phone: (303) 790-1020
 FAX: (303) 790-037



5500 Greenwood Plaza Blvd.
 Suite 150
 Greenwood Village, CO 80111
 Phone: 303/221-7275
 Fax: 303/221/7276

As Constructed

No. Revisions:	
Revised:	
Void:	

US 85 CROSS SECTIONS

Designer: DAF
 Detailer: DAF
 Sheet Subset: Roadway
 Subsets: of

Project No./Code
 NH 0852-086
 Sheet Number: 13429
 308

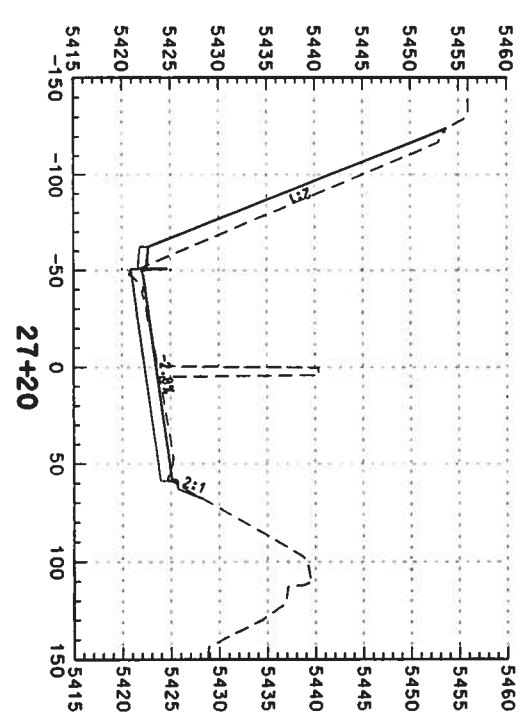
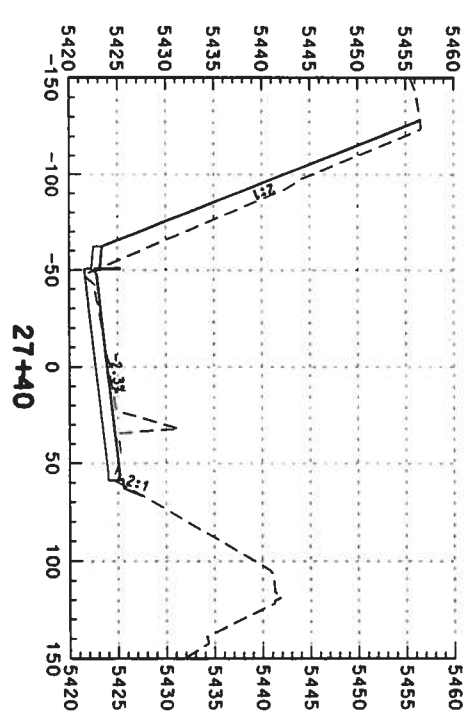
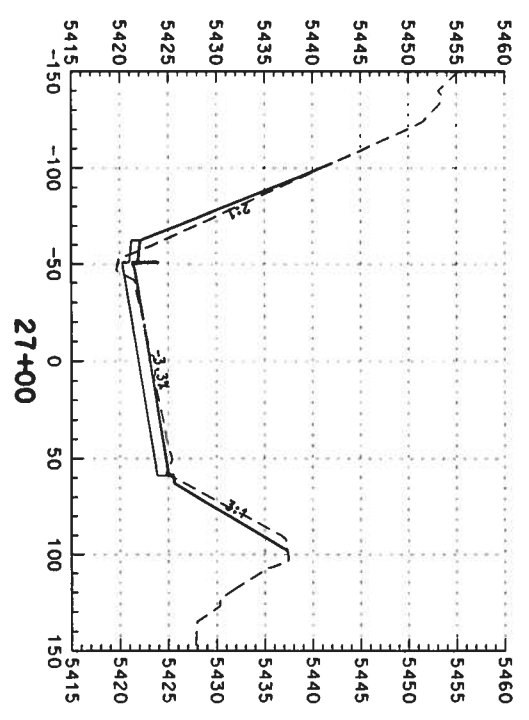
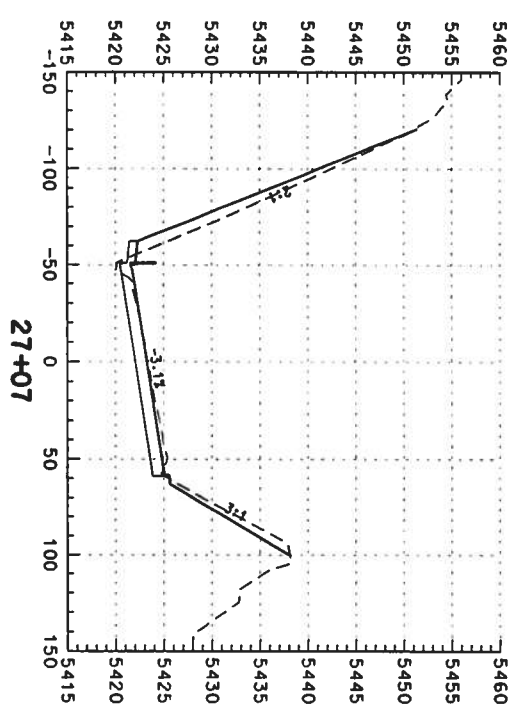
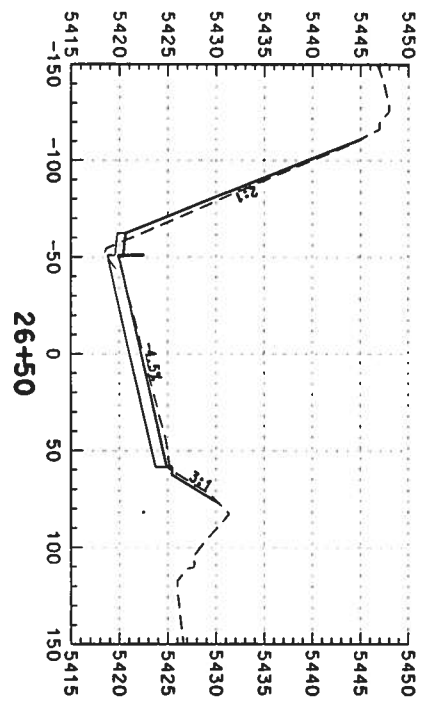
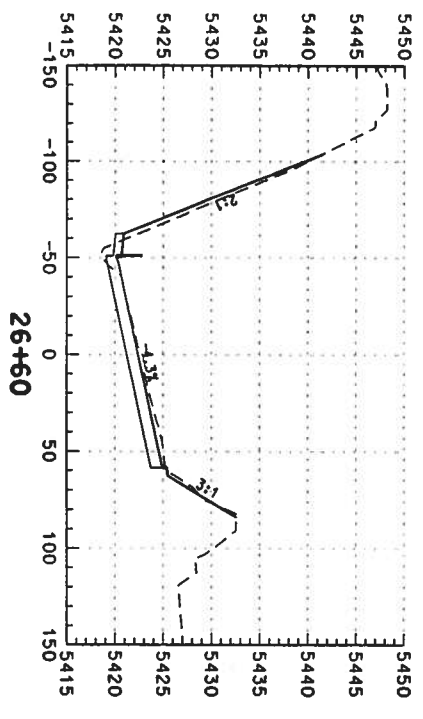
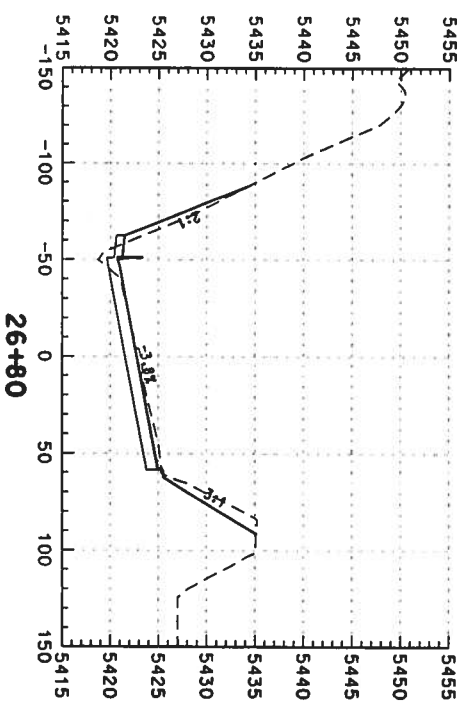

Computer File Information

Creation Date: 02/14/03 Initials: DAF
 Last Modification Date: Initials:
 Full Path: S:\Transport\246042\246042\HwyDes\Plans\
 Drawing File Name: rdxs-no-2d010.dgn
 Scale: Units: ENGLISH

Index of Revisions

359 Inverness Dr. South
 Suite K
 Englewood, CO 80112
 Phone: (303) 790-1020
 FAX: (303) 790-1037

REGION 1

5500 Greenwood Plaza Blvd.
 Suite 150
 Greenwood Village, CO 80111
 Phone: 303/221-7275
 Fax: 303/221/7276

As Constructed

No. Revisions:	
Revised:	
Void:	



US 85 CROSS SECTIONS

Designer:	DAF
Detailer:	DAF
Sheet Subset:	Roadway
Structure Numbers:	
Subset Sheets:	

Project No./Code

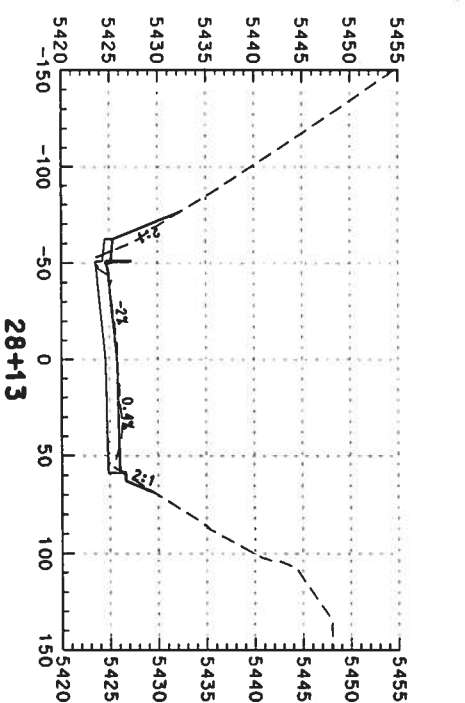
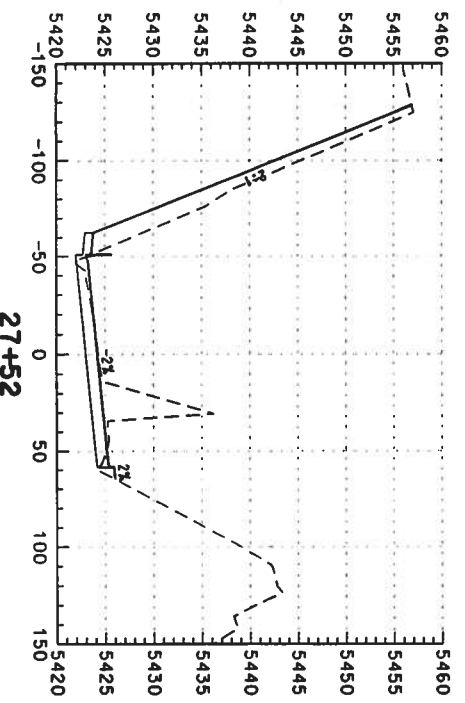
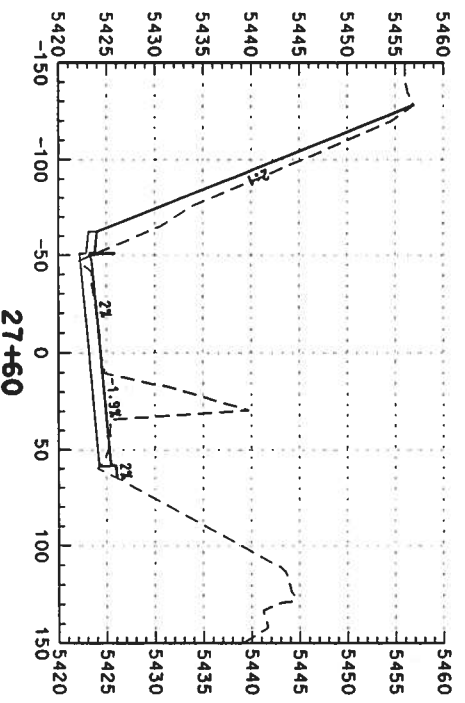
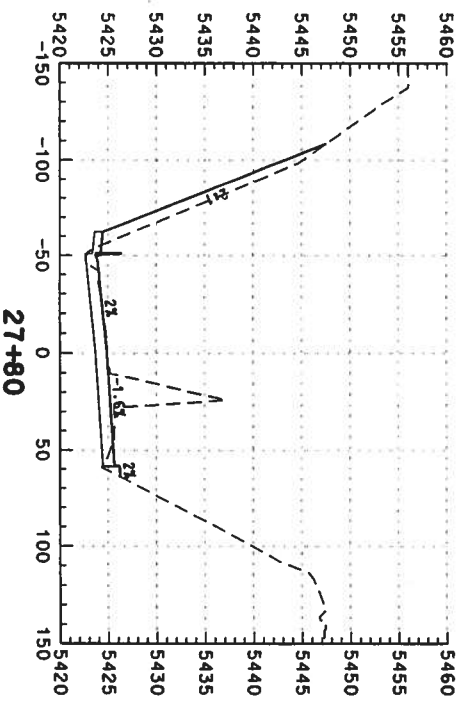
NH 0852-086
 13429
 Sheet Number: 309



Computer File Information		Index of Revisions		As Constructed		US 85 CROSS SECTIONS		Project No./Code	
Creation Date:	02/14/03	Initials:	DAF	No. Revisions:		Designer:	DAF	Structure	
Last Modification Date:		Initials:		Revised:		Detailer:	DAF	Numbers	
Full Path:	S:\Tranpro\ 246042\2\HwyDes\Plans\			Void:		Sheet Subset:	Roadway	Subset Sheets:	
Drawing File Name:	rdxs-no-2d011.dgn								of
Scale:	Units: ENGLISH								
 359 Inverness, Dr. South Suite K Englewood, CO 80112 Phone: (303) 790-1020 Fax: (303) 790-1037		 5500 Greenwood Plaza Blvd. Suite 150 Greenwood Village, CO 80111 Phone: 303/221-7275 Fax: 303/221/7276		REGION 1		US 85 CROSS SECTIONS		Sheet Number:	
								310	

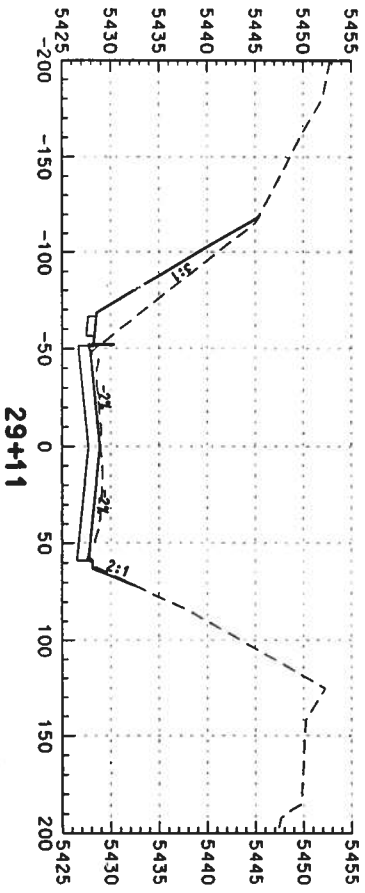
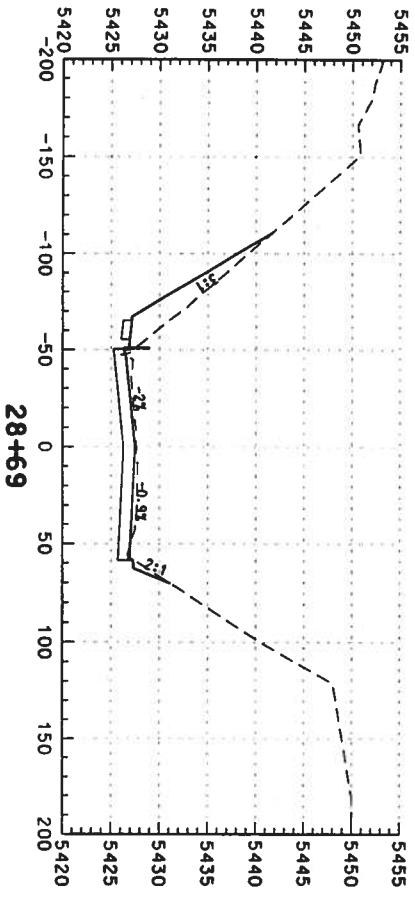
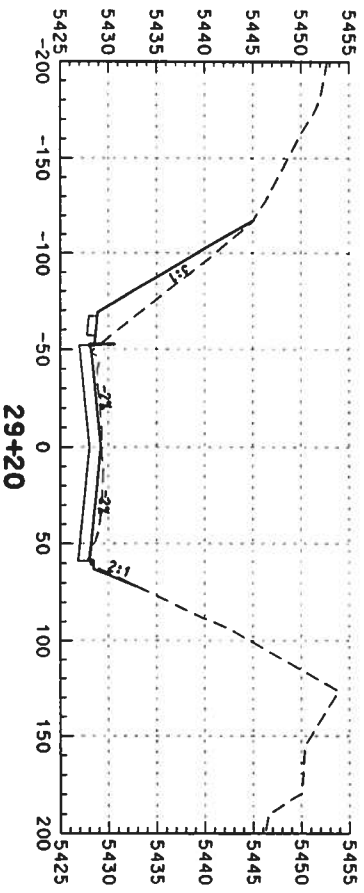
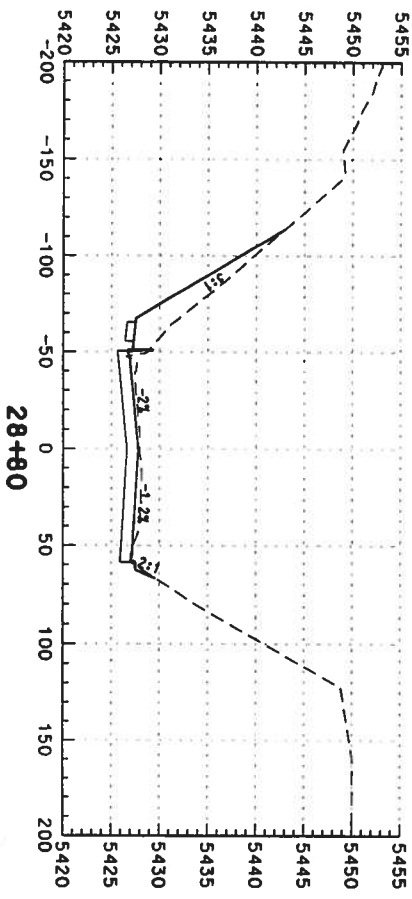
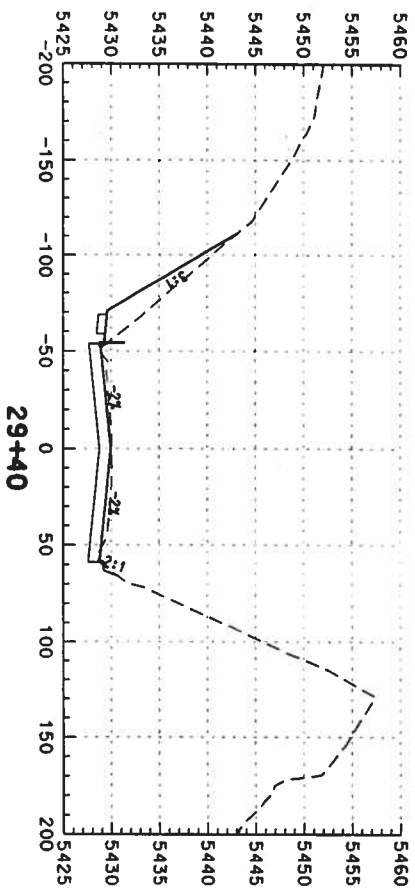
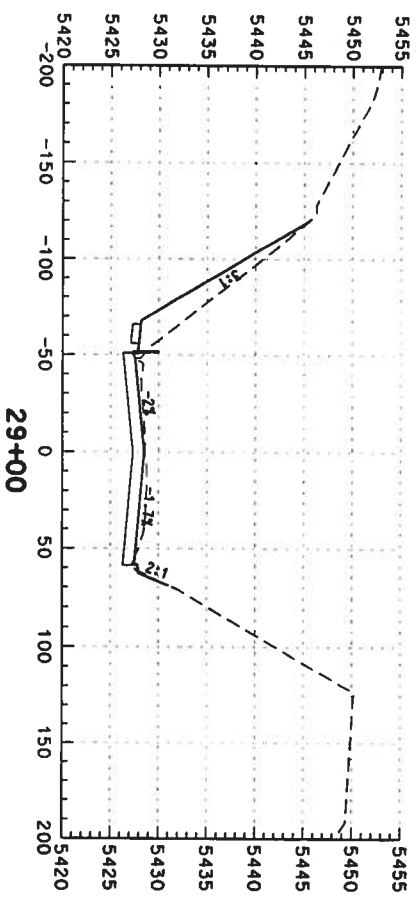

Computer File Information

Creation Date: 02/14/03 Initials: DAF
 Last Modification Date: Initials:
 Full Path: S:\Tranproj\246042.12\HwyDes\Plans\
 Drawing File Name: rdxs-no-20012.dgn
 Scale: Units: ENGLISH

Index of Revisions

No.	Description	Date	By



DEPARTMENT OF TRANSPORTATION
REGION 1
 359 Inverness Dr. South
 Suite K
 Englewood, CO 80112
 Phone: (303) 790-1020
 Fax: (303) 790-1037



5500 Greenwood Plaza Blvd.
 Suite 150
 Greenwood Village, CO 80111
 Phone: 303/221-7275
 Fax: 303/221/7276

As Constructed

No. Revisions:
 Revised:
 Void:

US 85 CROSS SECTIONS

Designer: DAF
 Detailer: DAF
 Sheet Subset: Roadway
 Subsheet Numbers:
 of

Project No./Code

NH 0852-086
 13429
 Sheet Number: 311

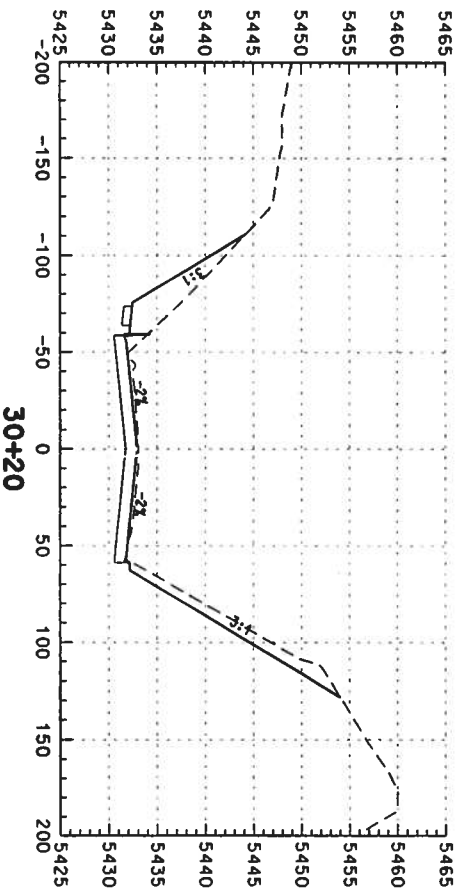
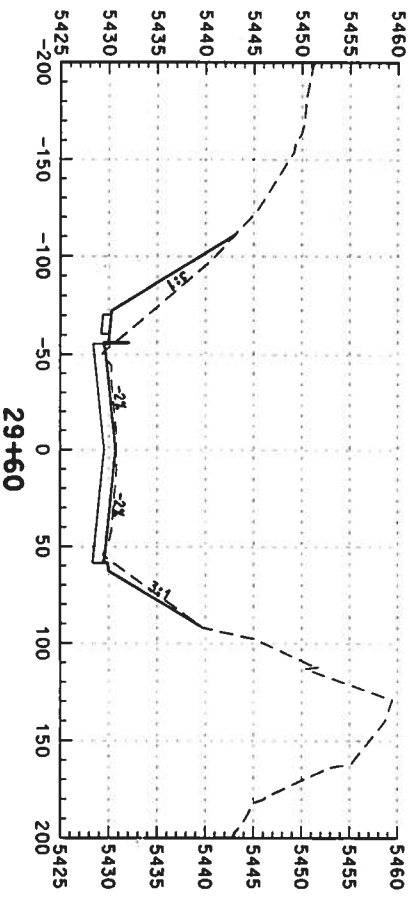
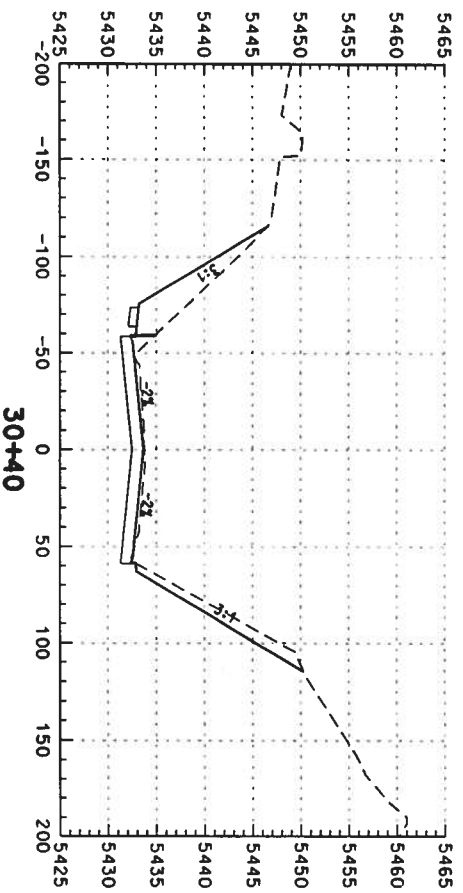
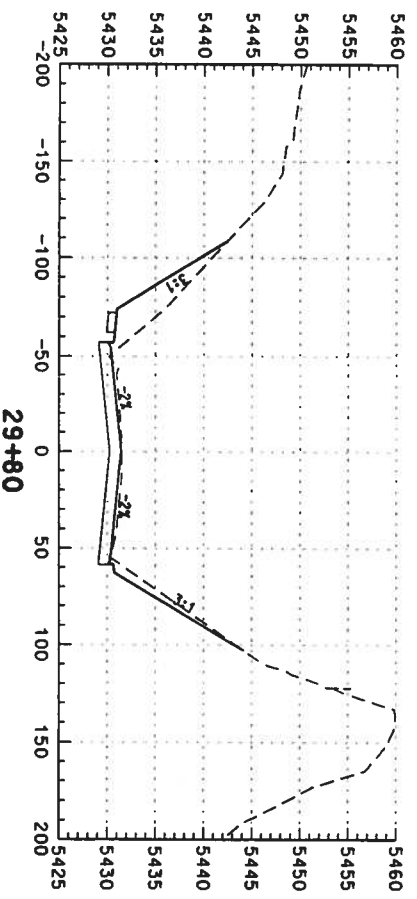
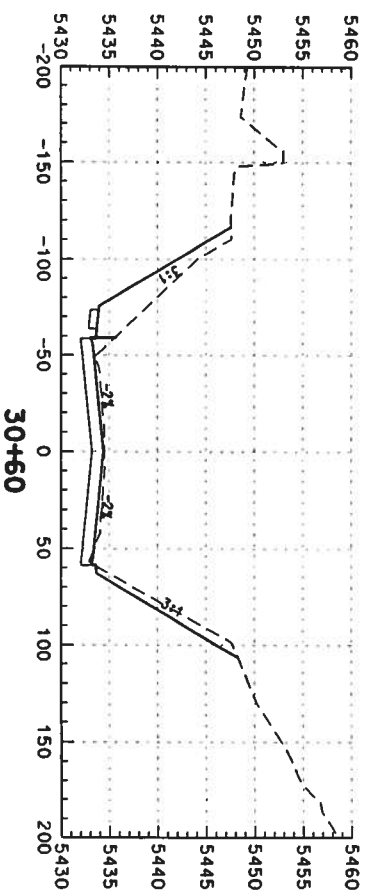
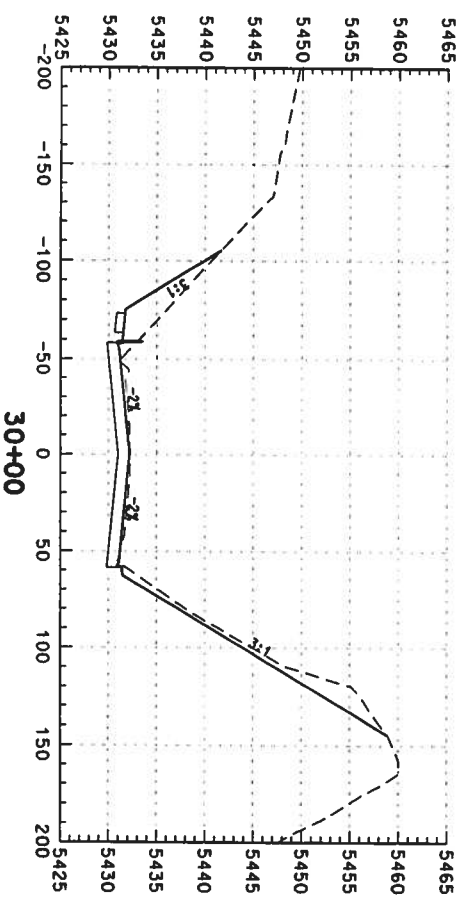

Computer File Information

Creation Date: 02/14/03 Initials: DAF
 Last Modification Date: Initials:
 Full Path: S:\Trampoj\246042.12\HwyDes\Plans\
 Drawing File Name: rdxs-no-2d013.dgn
 Scale: Units: ENGLISH

Index of Revisions

No.	Description	Date	By



DEPARTMENT OF TRANSPORTATION
REGION 1
 359 Inverness Dr. South
 Suite K
 Englewood, CO 80112
 Phone: (303) 790-1020
 Fax: (303) 790-1037



5500 Greenwood Plaza Blvd.
 Suite 150
 Greenwood Village, CO 80111
 Phone: 303/221-7275
 Fax: 303/221/7276

As Constructed

No. Revisions:
 Revised:
 Void:

US 85 CROSS SECTIONS

Designer: DAF
 Detailer: DAF
 Sheet Subset: Roadway
 Structure Numbers
 Subsets Sheets: of

Project No./Code

NH 0852-086
 13429
 Sheet Number: 312

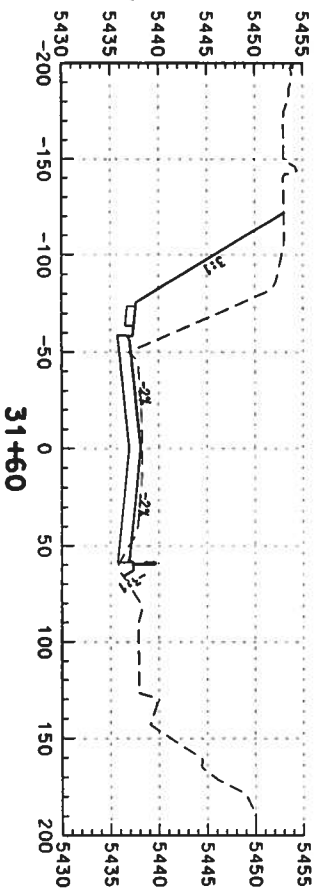
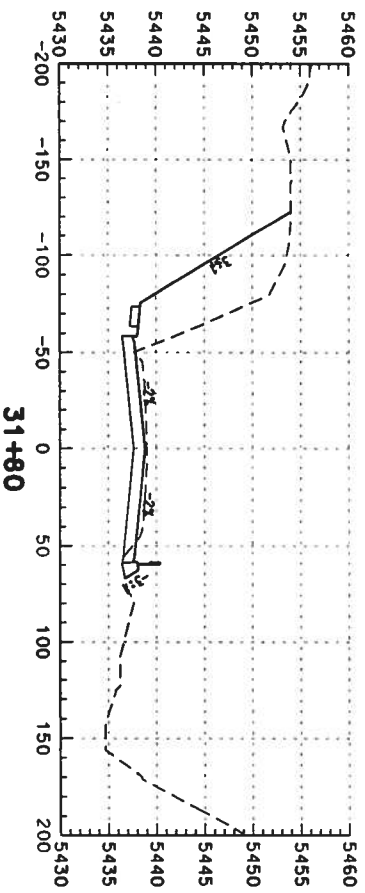
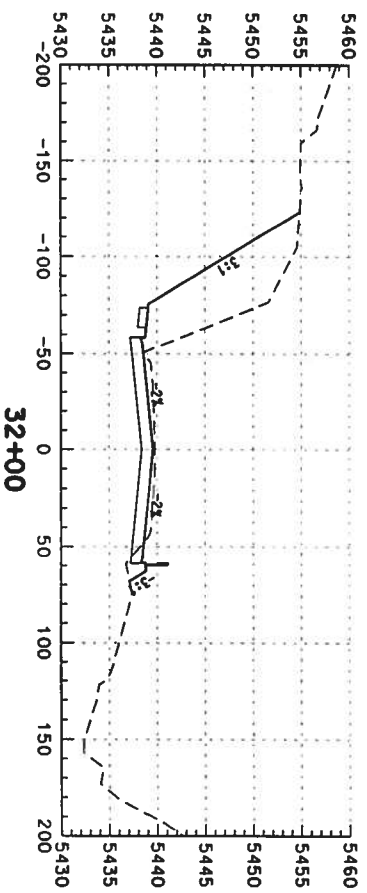
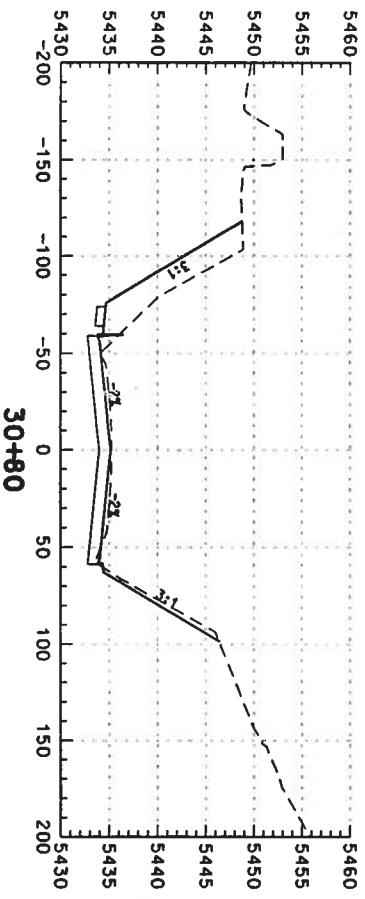
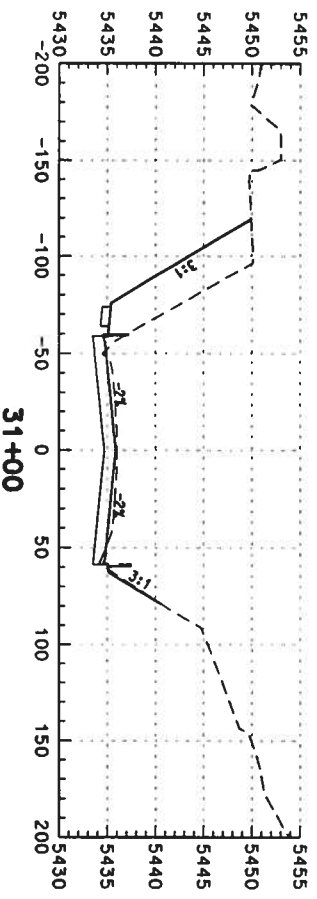
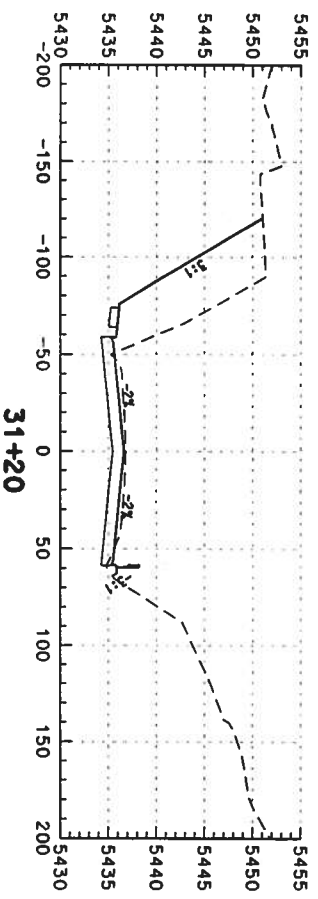
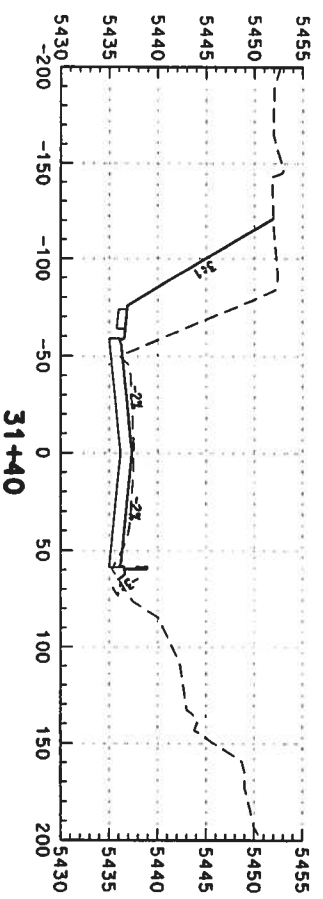

Computer File Information

Creation Date: 02/14/03 Initials: DAF
 Last Modification Date: Initials:
 Full Path: S:\Transport\246042\2\HwyDes\Plans\
 Drawing File Name: rdxs-no-2d014.dgn
 Scale: Units: ENGLISH

Index of Revisions

No.	Description	Date	By



339 Inverness Dr. South
 Suite K
 Englewood, CO 80112
 Phone: (303) 790-1020
 Fax: (303) 790-1037



5500 Greenwood Plaza Blvd.
 Suite 150
 Greenwood Village, CO 80111
 Phone: 303/221-7275
 Fax: 303/221/7276

As Constructed
 No. Revisions:
 Revised:
 Void:

US 85 CROSS SECTIONS
 Designer: DAF
 Detailer: DAF
 Sheet Subset: Roadway
 Subset Sheets: of

Project No./Code
 NH 0852-086
 Sheet Number: 13429
 of 313

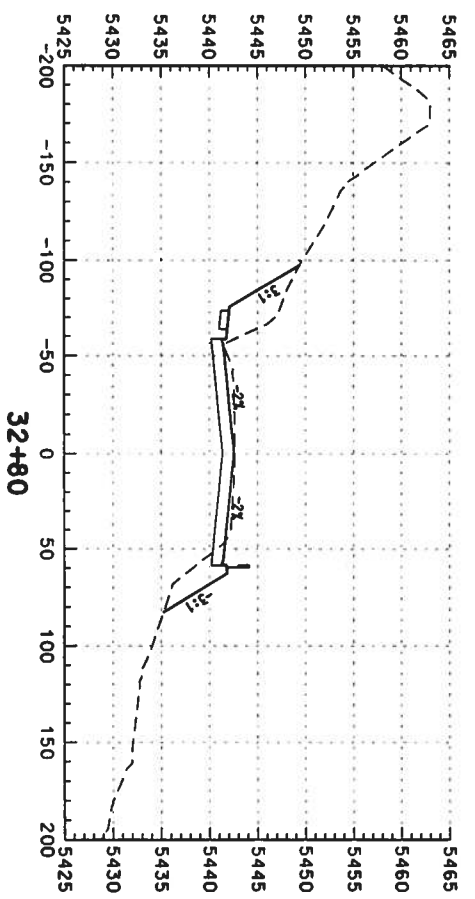
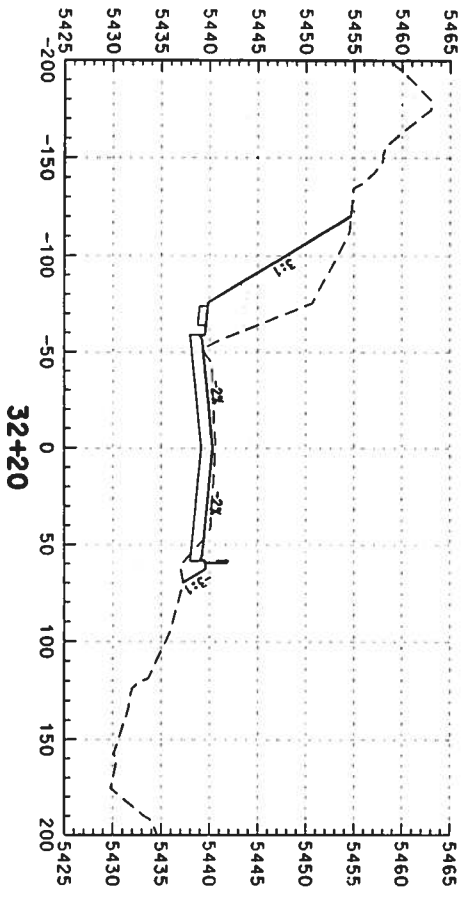
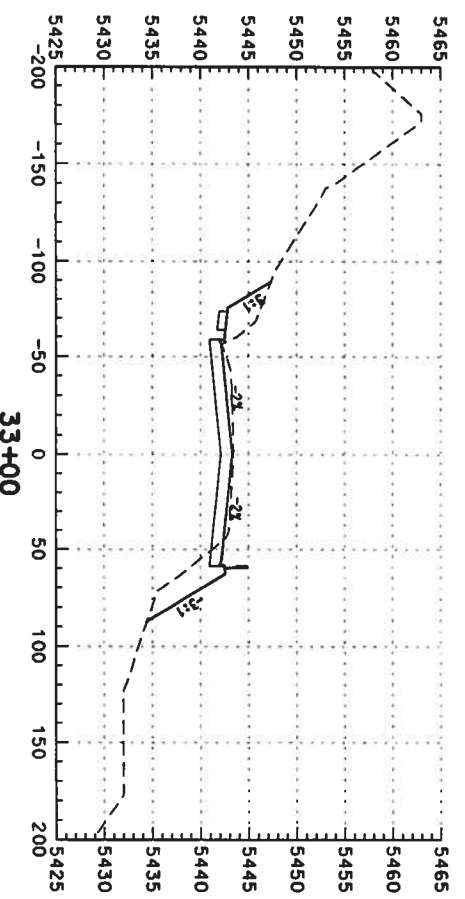
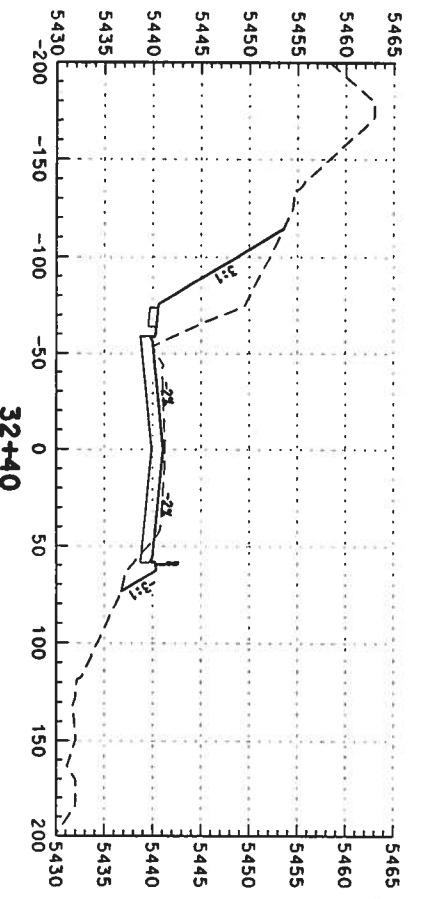
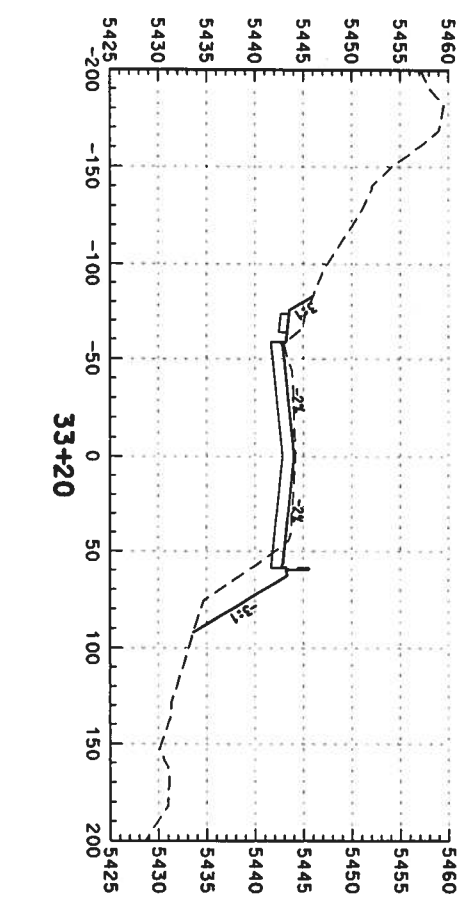
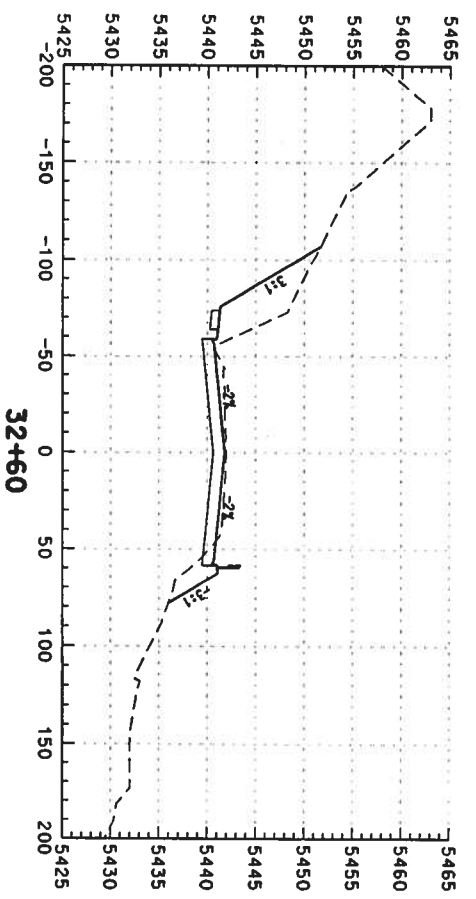

Computer File Information

Creation Date: 02/14/03 Initials: DAF
 Last Modification Date: Initials:
 Full Path: S:\Tranpro\246042.12\HWDes\Plans\
 Drawing File Name: r dxs-no-2d015.dgn
 Scale: Units: ENGLISH

Index of Revisions

No.	Description	Date	By



359 Inverness Dr. South
 Suite K
 Englewood, CO 80112
 Phone: (303) 790-1020
 Fax: (303) 790-1037



5500 Greenwood Plaza Blvd.
 Suite 150
 Greenwood Village, CO 80111
 Phone: 303/221-7275
 Fax: 303/221/7276

As Constructed

No. Revisions:
 Revised:
 Void:

US 85 CROSS SECTIONS

Designer: DAF
 Detailer: DAF
 Sheet Subset: Roadway
 Structure Numbers
 Subset Sheets: of

Project No./Code

NH 0852-086
 13429
 Sheet Number: 314

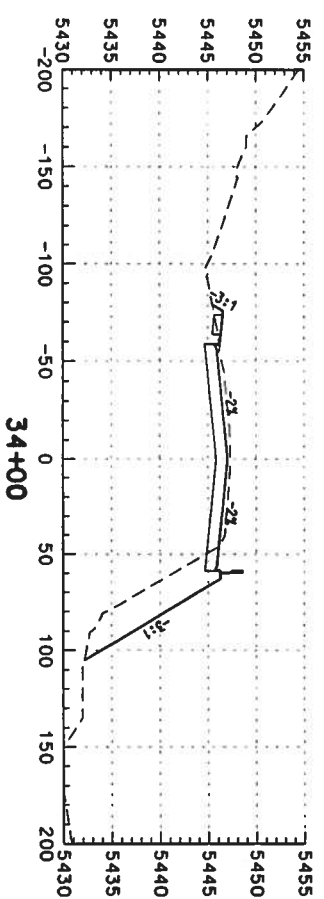
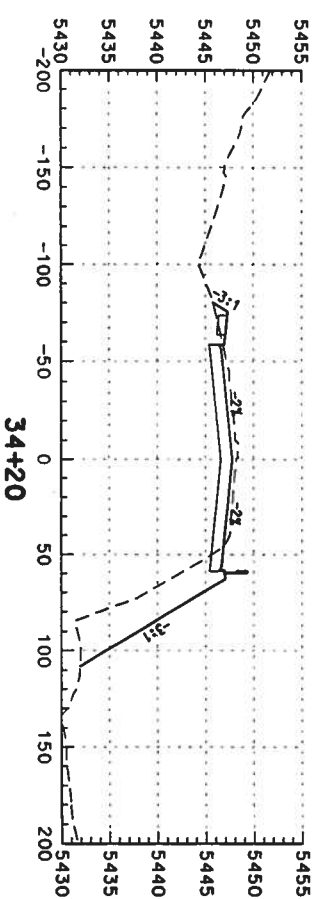
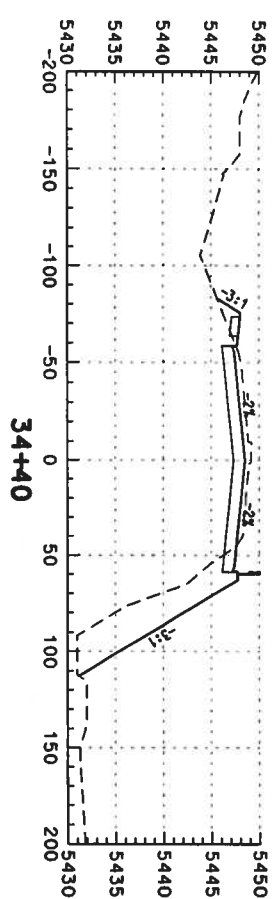
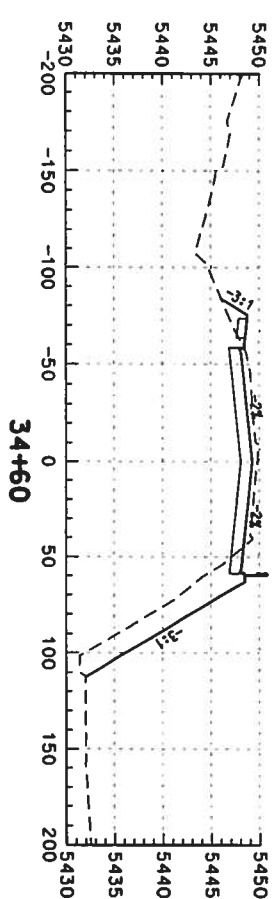
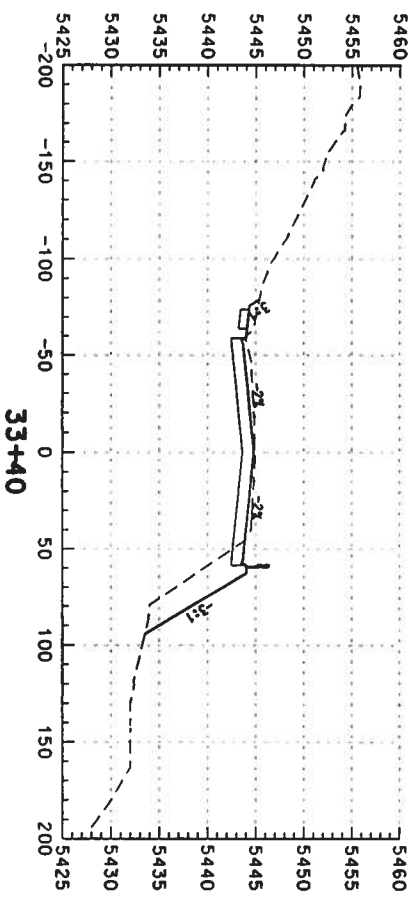
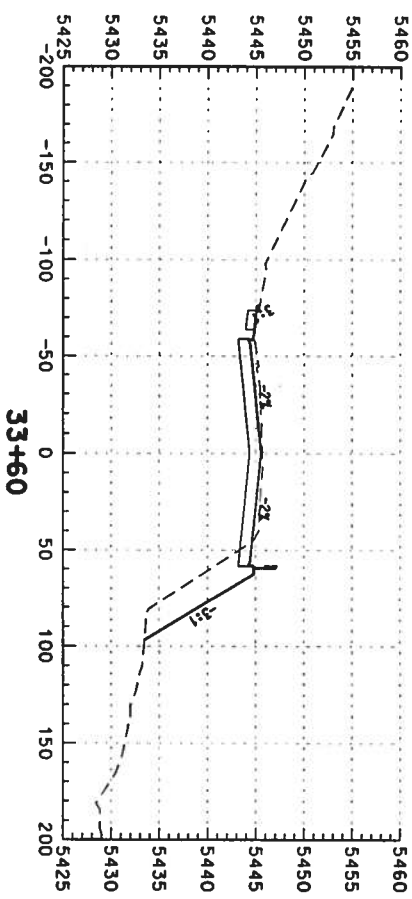
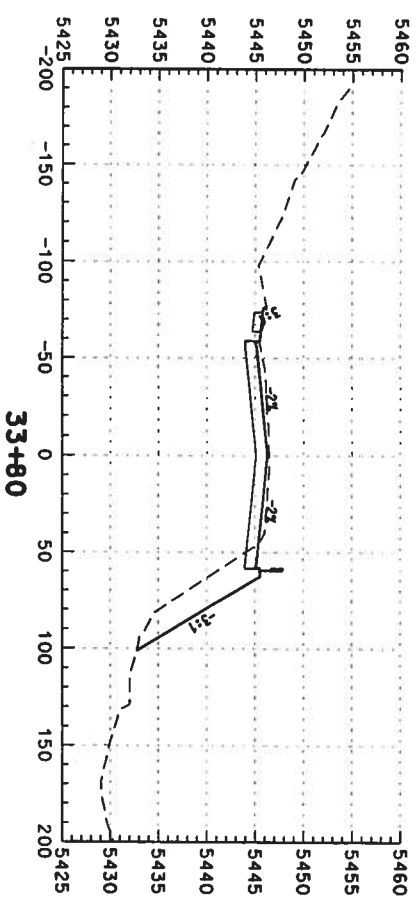

Computer File Information		Index of Revisions				As Constructed		US 85 CROSS SECTIONS		Project No./Code	
Creation Date:	02/14/03	Initials:	DAF				No. Revisions:				NH 0852-086
Last Modification Date:		Initials:					Revised:		Designer:	DAF	Sheet Number:
Full Path:	S:\Transport\24604.2\HwyDes\Plans\						Void:		Detailer:	DAF	13429
Drawing File Name:	r dxs-no-2d016.dgn								Sheet Subset:	Roadway	315
Scale:	Units: ENGLISH								Subset Sheets:		of
				REGION 1							
				359 Inverness Dr. South Suite K Englewood, CO 80112 Phone: (303) 790-1020 Fax: (303) 790-1037				5500 Greenwood Plaza Blvd. Suite 150 Greenwood Village, CO 80111 Phone: 303/221-7275 Fax: 303/221/7276			

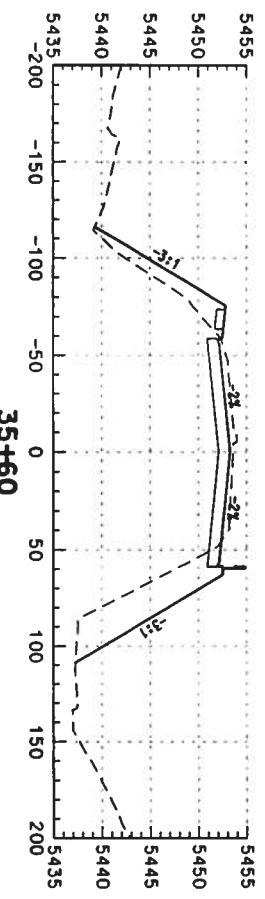
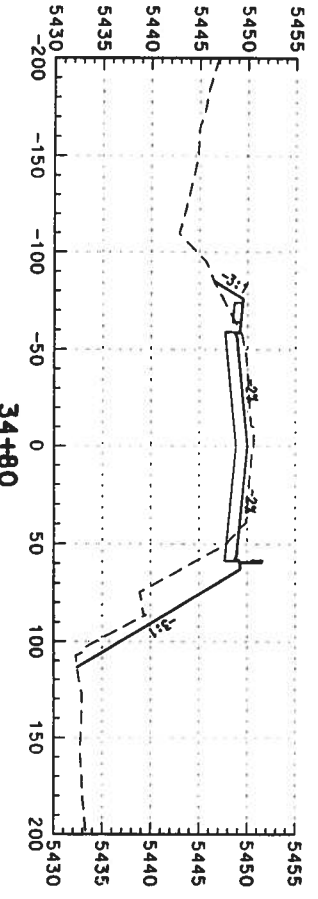
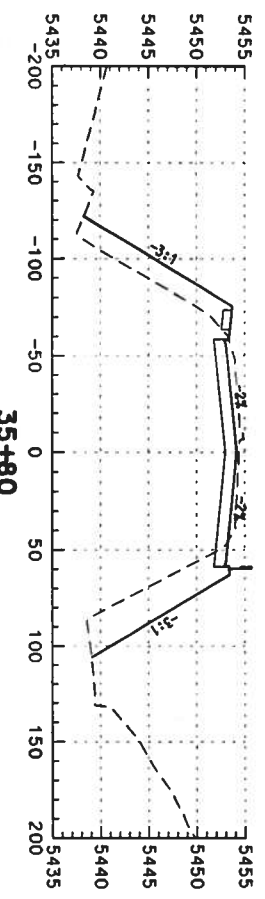
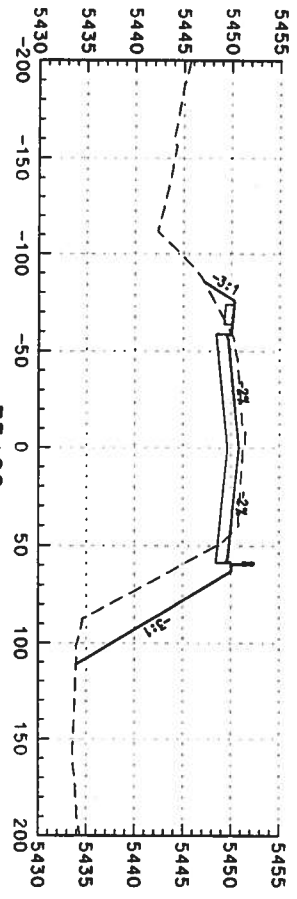
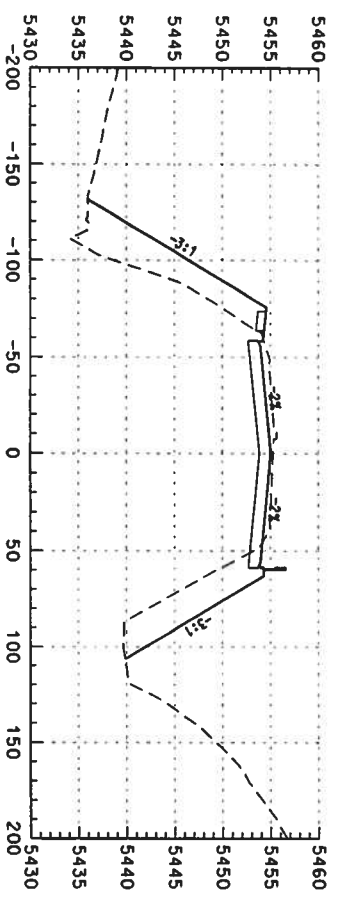
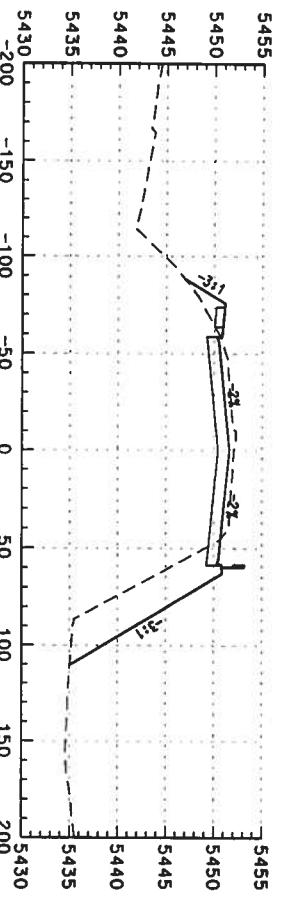
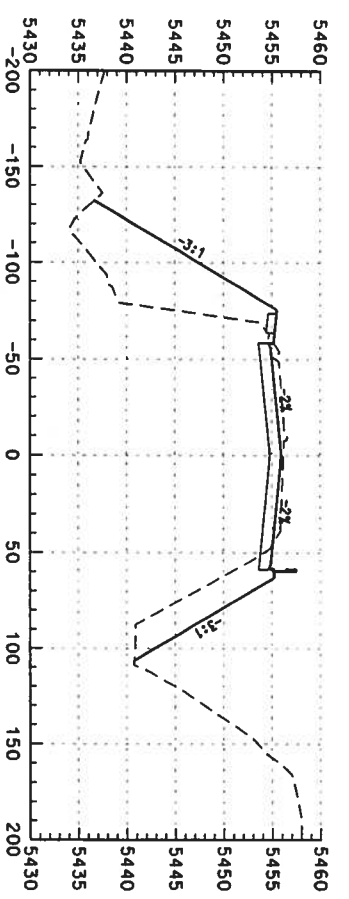
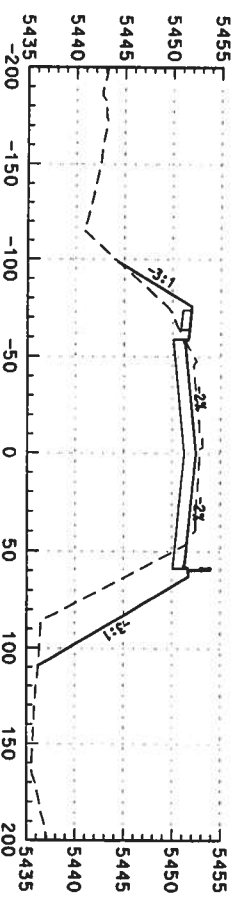

Computer File Information

Creation Date: 02/14/03 Initials: DAF
 Last Modification Date: Initials:
 Full Path: S:\Tranpro\246042.12\HwyDes\Plans\
 Drawing File Name: rdxs-no-2d017.dgn
 Scale: Units: ENGLISH

Index of Revisions

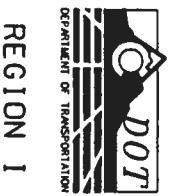

359 Inverness Dr. South
 Suite K
 Englewood, CO 80112
 Phone: (303) 790-1020
 Fax: (303) 790-1037

PBSJ
 5500 Greenwood Plaza Blvd.
 Suite 150
 Greenwood Village, CO 80111
 Phone: 303/221-7275
 Fax: 303/221/7276

As Constructed

No. Revisions:
 Revised:
 Void:

US 85 CROSS SECTIONS

Designer: DAF
 Detailer: DAF
 Sheet Subset: Roadway
 Subsets Sheets: of

Project No./Code

NH 0852-086
 13429
 Sheet Number: 316

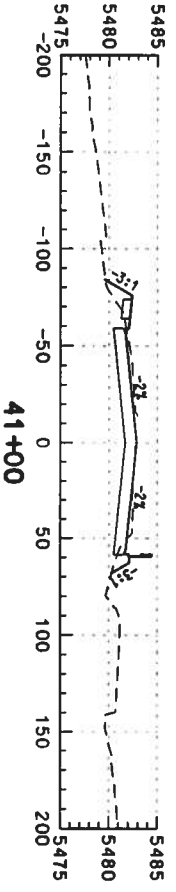
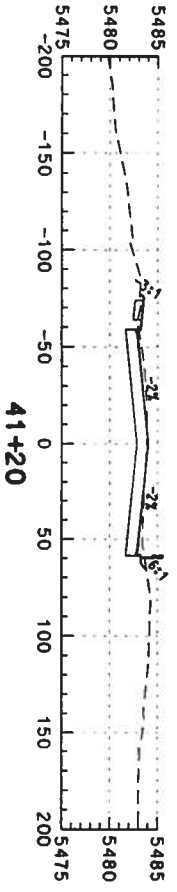
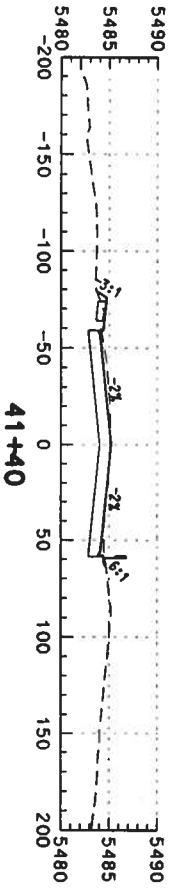
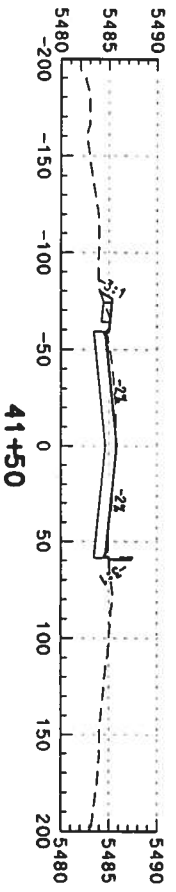
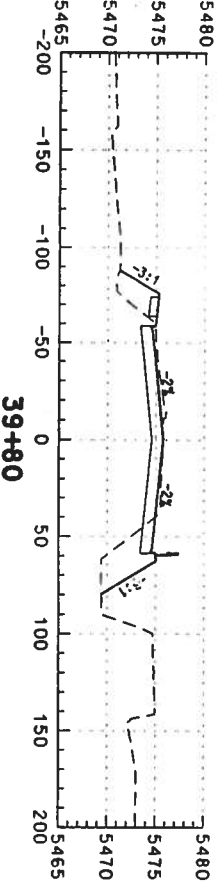
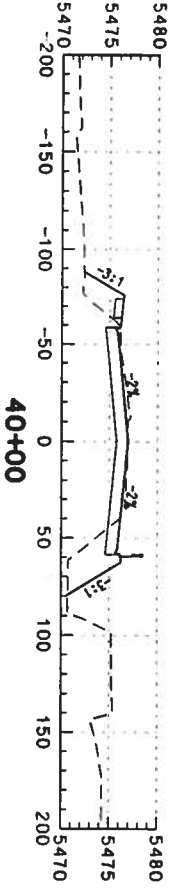
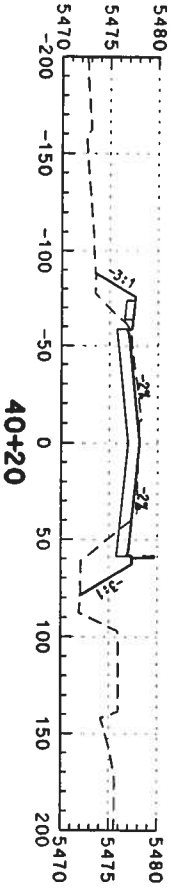
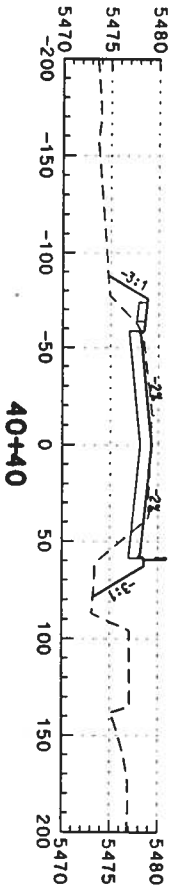
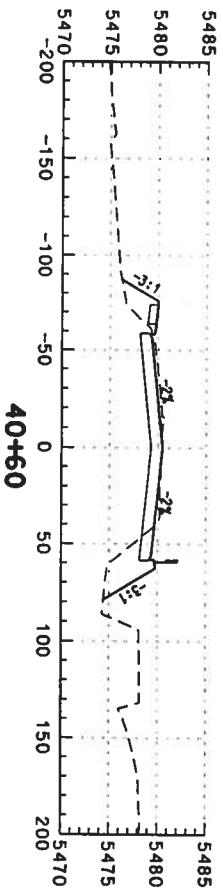
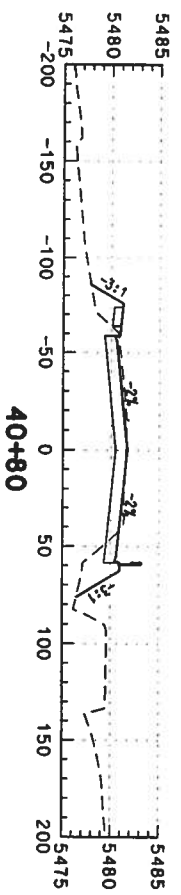

Computer File Information

Creation Date: 02/14/03 Initials: DAF
 Last Modification Date: Initials:
 Full Path: S:\Tranpro\246042.12\HwyDes\Plans\
 Drawing File Name: rdxs-no-2d020.dgn
 Scale: Units: ENGLISH

Index of Revisions



359 Inverness Dr. South
 Suite K
 Englewood, CO 80112
 Phone: (303) 790-1020
 Fax: (303) 790-1037



5500 Greenwood Plaza Blvd.
 Suite 150
 Greenwood Village, CO 80111
 Phone: 303/221-7275
 Fax: 303/221/7276

As Constructed

No. Revisions:
 Revised:
 Void:

US 85 CROSS SECTIONS

Designer: DAF Structure
 Detailer: DAF Numbers
 Sheet Subset: Roadway Subset Sheets: of

Project No./Code

NH 0852-086
 13429
 Sheet Number: 319

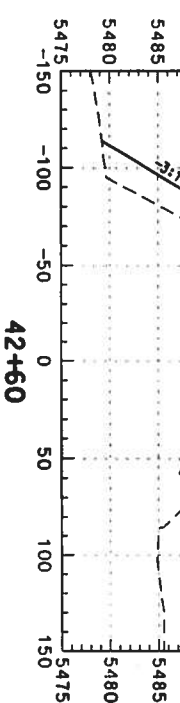
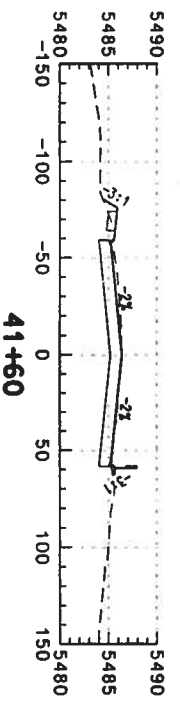
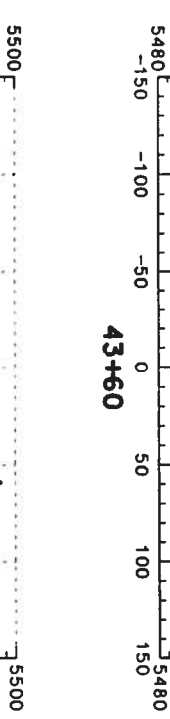
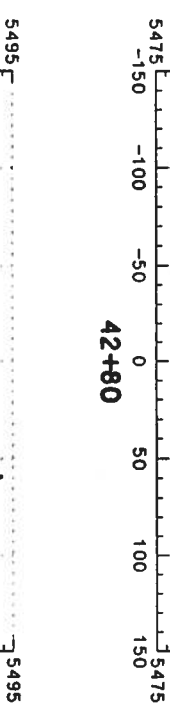
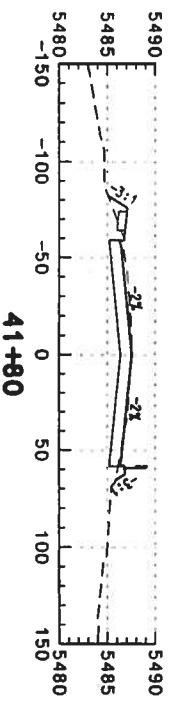
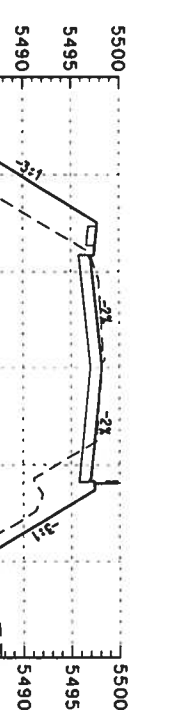
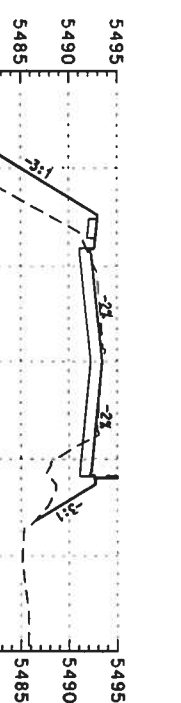
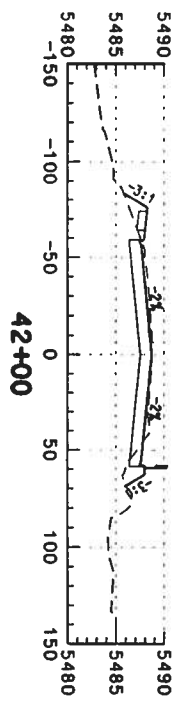
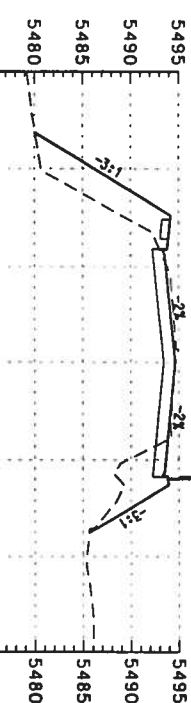
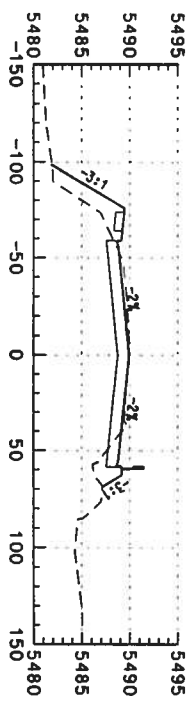
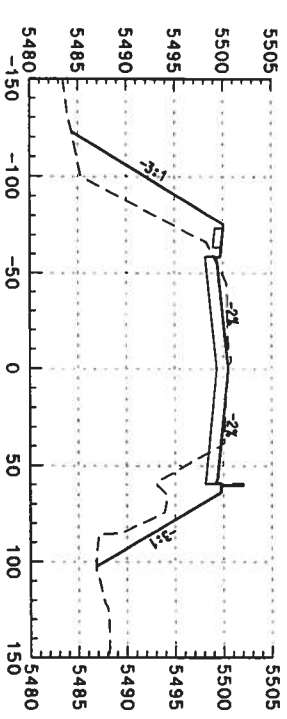
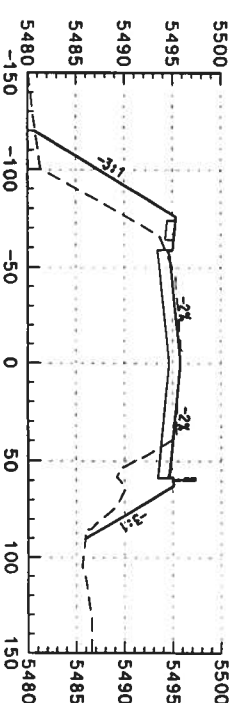
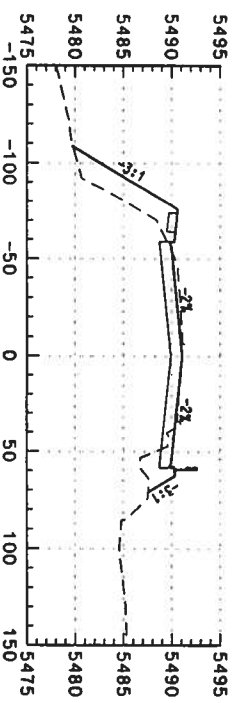

Computer File Information

Creation Date: 02/14/03 Initials: DAF
 Lost Modification Date: Initials:
 Full Path: S:\Tranpro\246042\2\HwyDes\Plans\
 Drawing File Name: rdxs-no-2d021.dgn
 Scale: Units: ENGLISH

Index of Revisions

No.	Description	Date	By



359 Inverness Dr. South
 Suite K
 Englewood, CO 80112
 Phone: (303) 790-1020
 Fax: (303) 790-1037

REGION 1



5500 Greenwood Plaza Blvd.
 Suite 150
 Greenwood Village, CO 80111
 Phone: 303/221-7275
 Fax: 303/221/7276

As Constructed

No. Revisions:
 Revised:
 Void:

US 85 CROSS SECTIONS

Designer: DAF
 Checker: DAF
 Sheet Subset: Roadway
 Subset Sheets: of

Project No./Code

NH 0852-086
 13429
 Sheet Number: 320

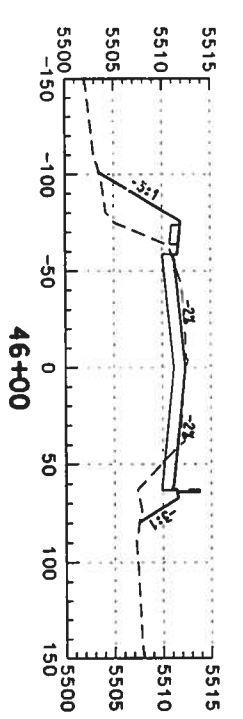
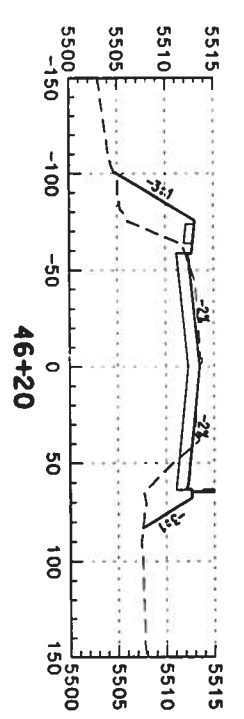
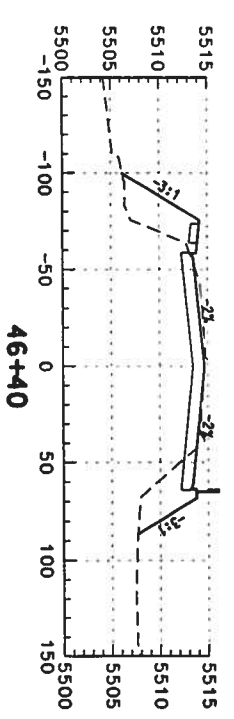
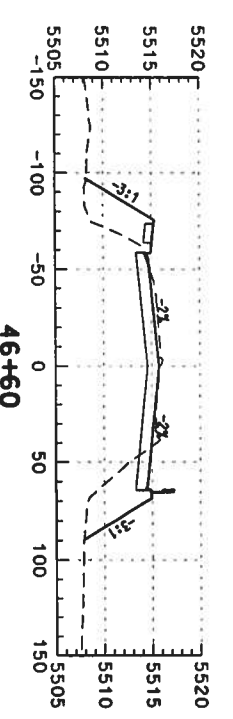
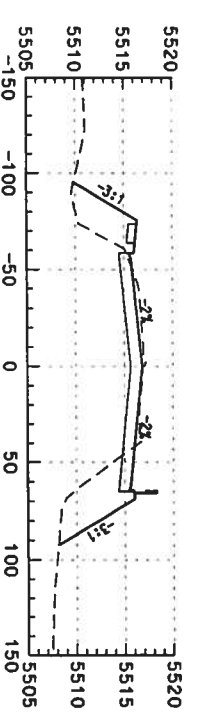
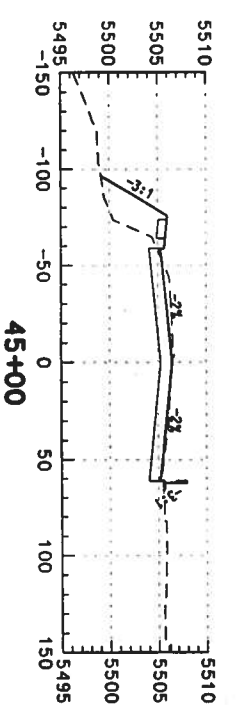
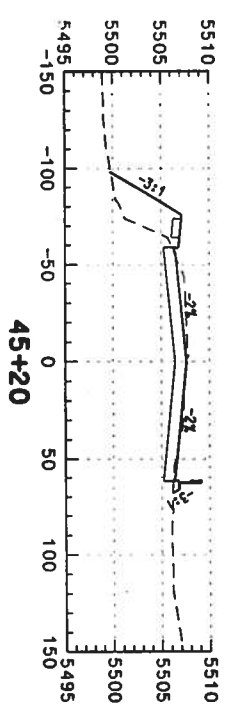
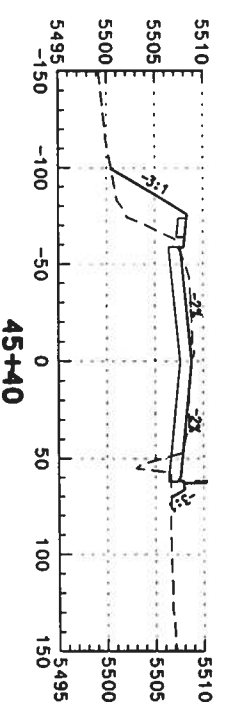
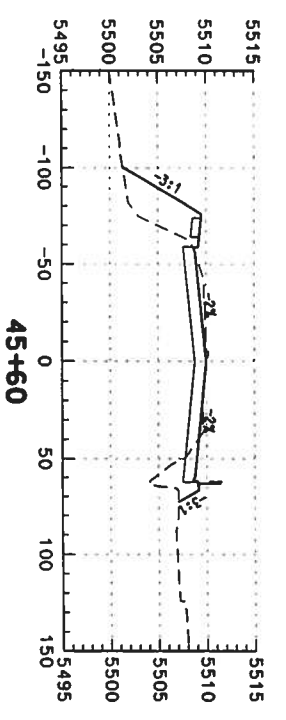
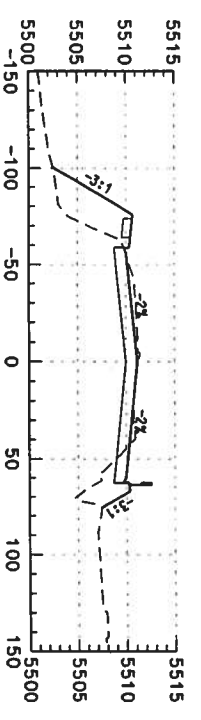
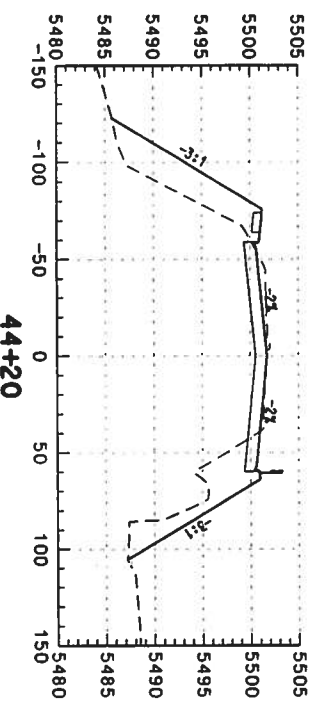
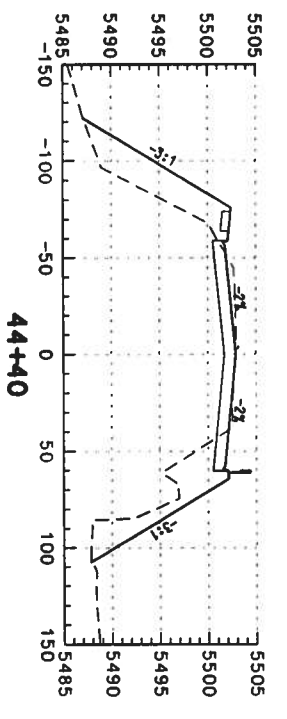
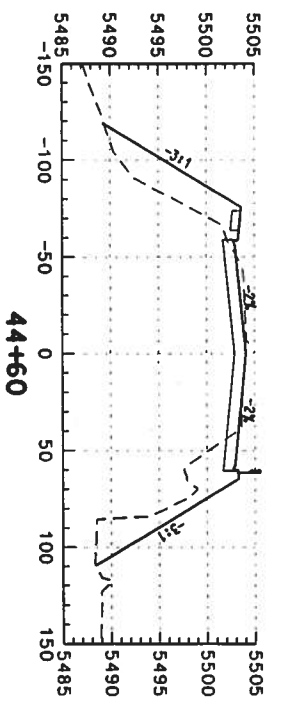
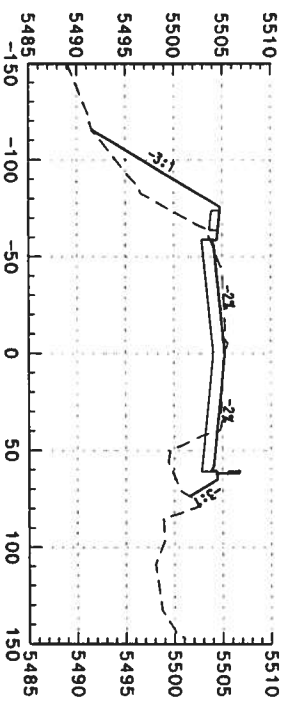

Computer File Information
 Creation Date: 02/14/03 Initials: DAF
 Last Modification Date: Initials:
 Full Path: S:\Tranproj\2460+2.12\HwyDes\Plans\
 Drawing File Name: rdxs-no-2d022.dgn
 Scale: Units: ENGLISH

Index of Revisions

DOT
 DEPARTMENT OF TRANSPORTATION
 REGION 1
 359 Inverness Dr. South
 Suite K
 Englewood, CO 80112
 Phone: (303) 790-1020
 Fax: (303) 790-1037

PBSJ
 5500 Greenwood Plaza Blvd.
 Suite 150
 Greenwood Village, CO 80111
 Phone: 303/221-7275
 Fax: 303/221/7276

As Constructed
 No. Revisions:
 Revised:
 Void:

US 85 CROSS SECTIONS
 Designer: DAF
 Detailer: DAF
 Sheet Subset: Roadway
 Subset Sheets: of

Project No./Code
 NH 0852-086
 Sheet Number: 321

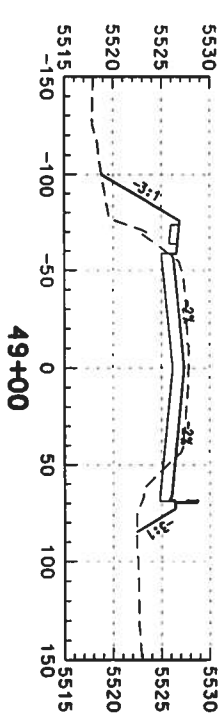
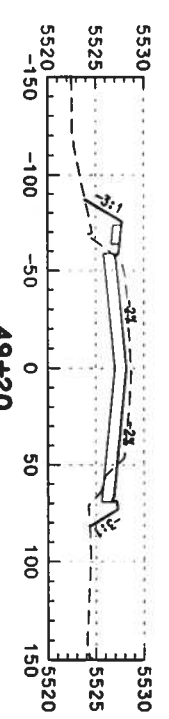
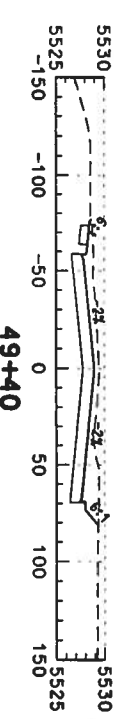
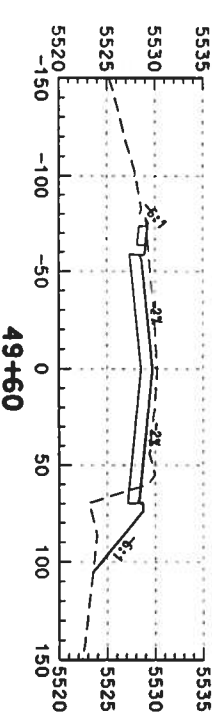
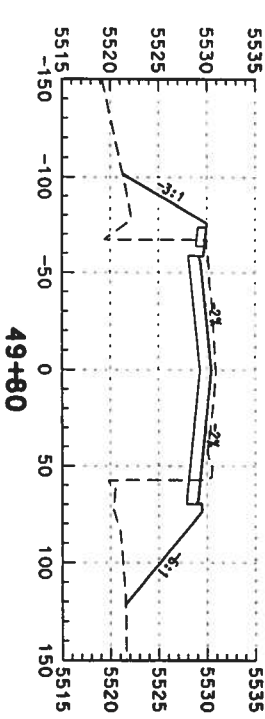
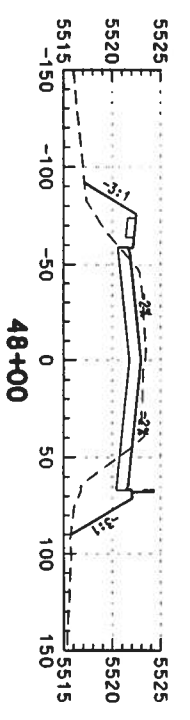
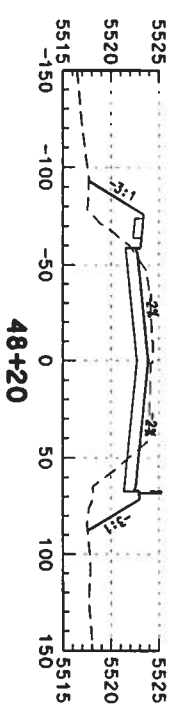
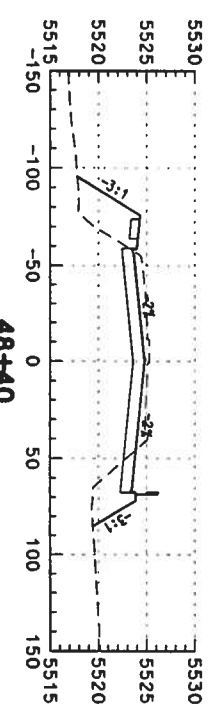
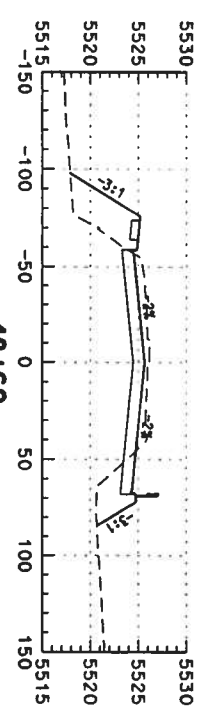
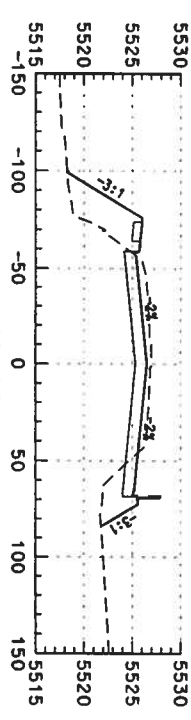
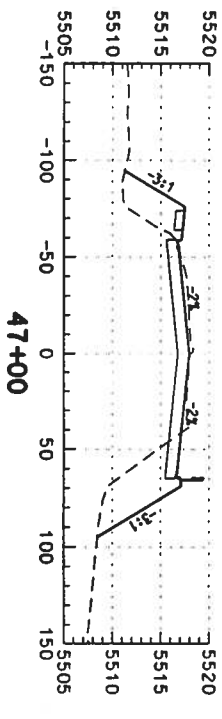
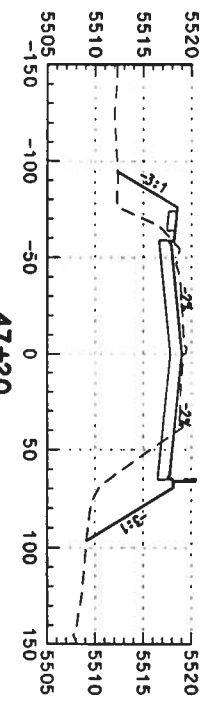
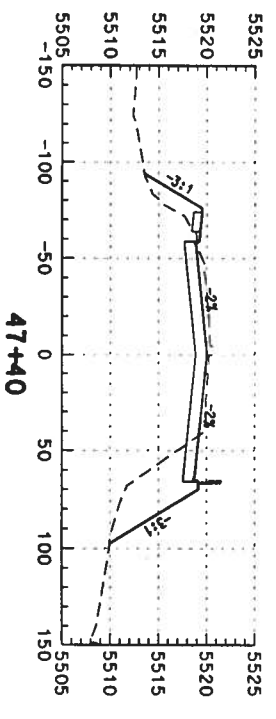
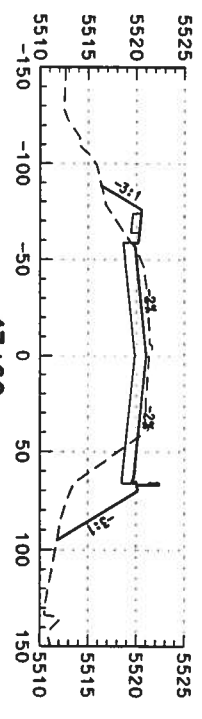
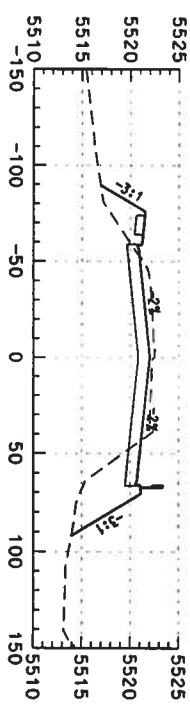

Computer File Information	
Creation Date:	02/14/03
Last Modification Date:	
Initials:	DAF
Full Path:	S:\Temp\proj\246042.12\HwyDes\Plans\rdxs-no-24023.dgn
Drawing File Name:	rdxs-no-24023.dgn
Scale:	Units: ENGLISH

Index of Revisions	



DOT
DEPARTMENT OF TRANSPORTATION

359 Inverness Dr. South
Suite K
Englewood, CO 80112
Phone: (303) 790-1020
Fax: (303) 790-1037

PBSJ
5500 Greenwood Plaza Blvd.
Suite 150
Greenwood Village, CO 80111
Phone: 303/221-7275
Fax: 303/221/7276

As Constructed	
No. Revisions:	
Revised:	
Void:	

US 85 CROSS SECTIONS	
Designer:	DAF
Detailer:	DAF
Sheet Subset:	Roadway
Subsect Sheets:	
	of

Project No./Code	
NH 0852-086	
13429	
Sheet Number:	322

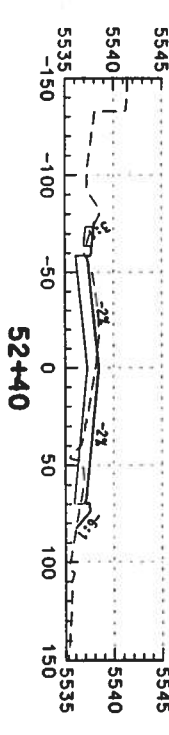
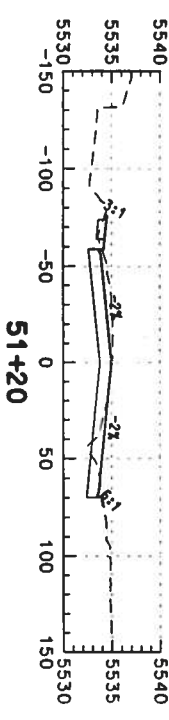
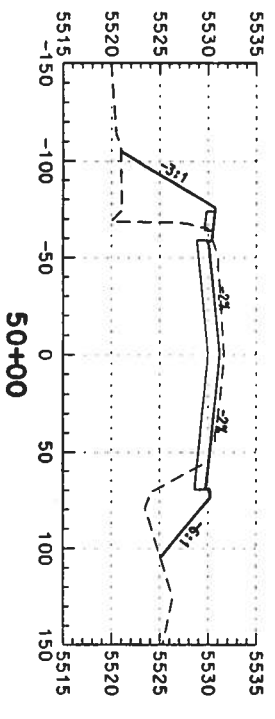
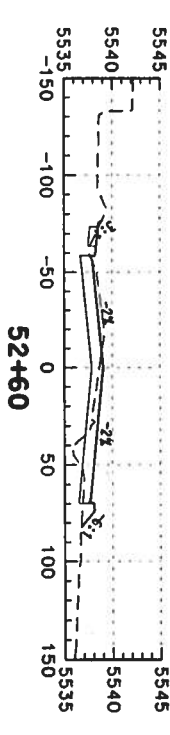
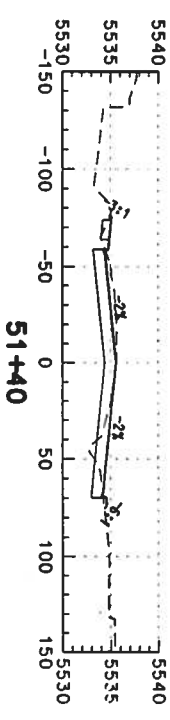
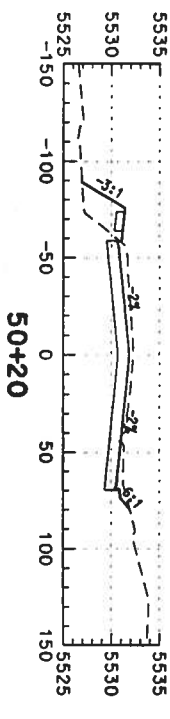
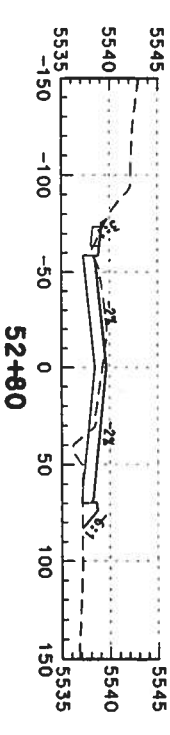
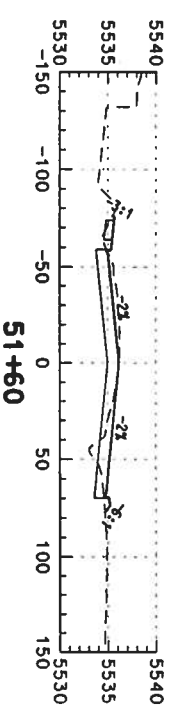
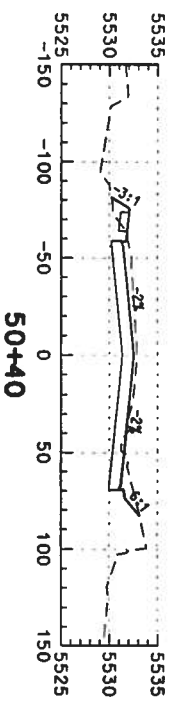
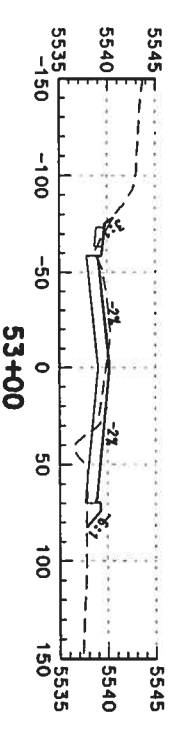
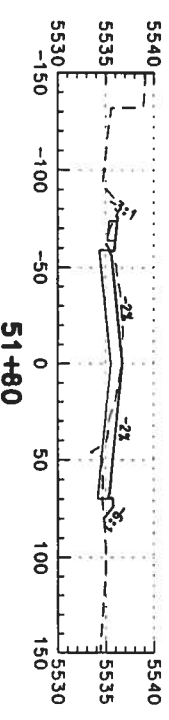
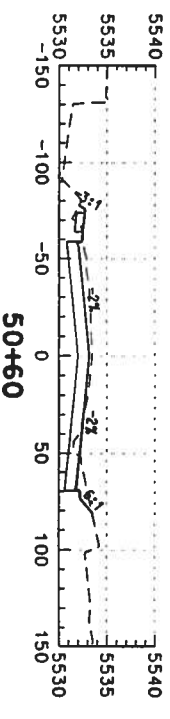
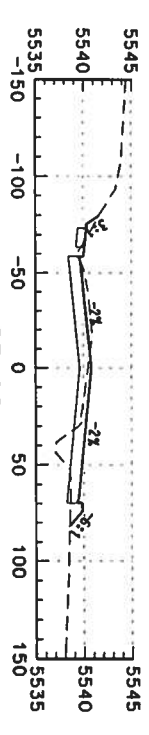
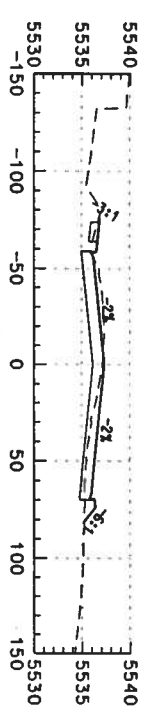
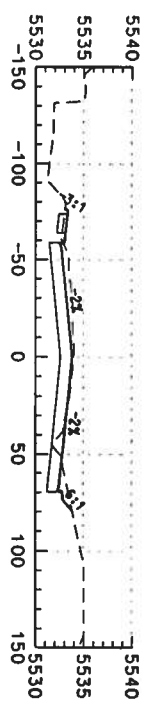
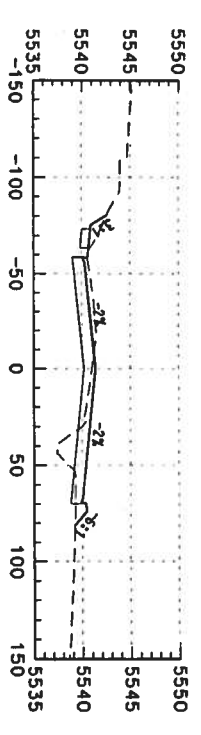
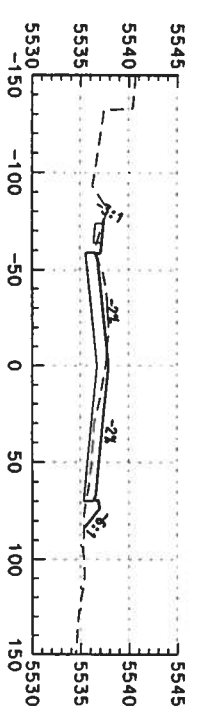
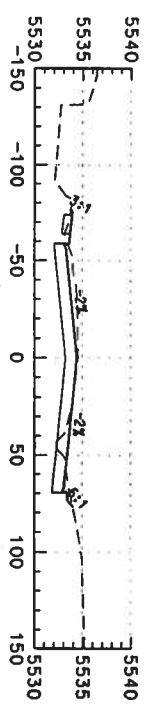

Computer File Information	
Creation Date:	02/14/03
Last Modification Date:	
Initials:	DAF
Full Path:	S:\Temp\proj\246042.12\HwyDes\Plans\
Drawing File Name:	r\dws-no-24024.dgn
Scale:	Units: ENGLISH

Index of Revisions	



DOT
DEPARTMENT OF TRANSPORTATION

359 Inverness Dr. South
Suite K
Englewood, CO 80112
Phone: (303) 790-1020
FAX: (303) 790-1037

PBSJ



5500 Greenwood Plaza Blvd.
Suite 150
Greenwood Village, CO 80111
Phone: 303/221-7275
Fax: 303/221/7276

As Constructed	
No. Revisions:	
Revised:	
Void:	

US 85 CROSS SECTIONS			
Designer:	DAF	Structure	
Detailer:	DAF	Numbers	
Sheet Subset:	Roadway	Subset Sheets:	

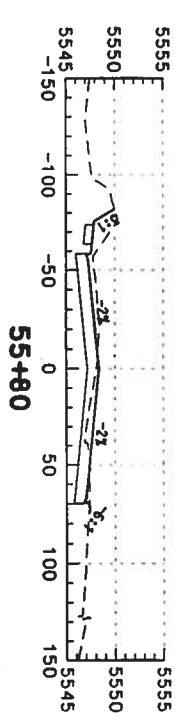
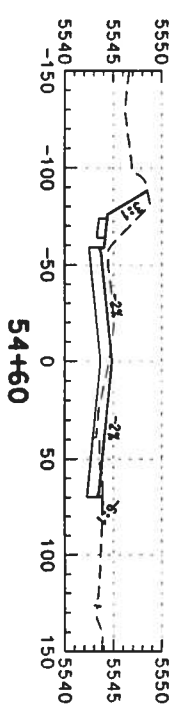
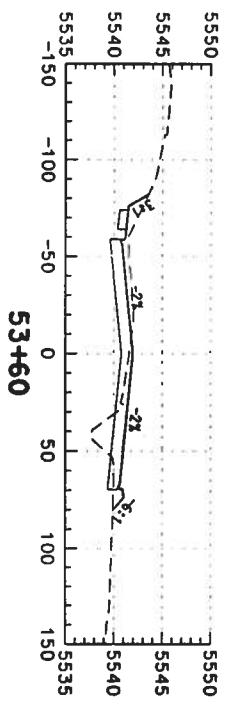
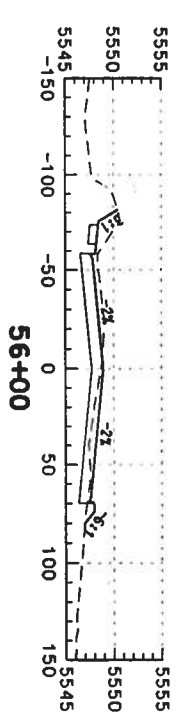
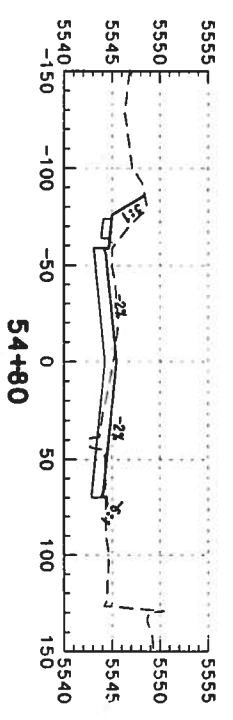
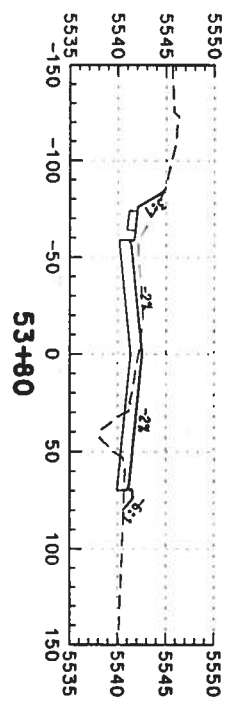
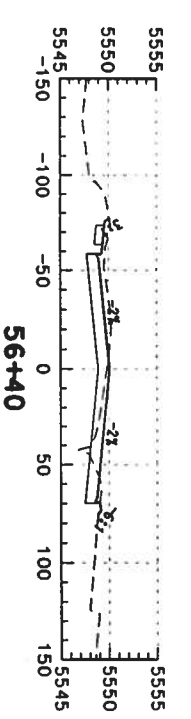
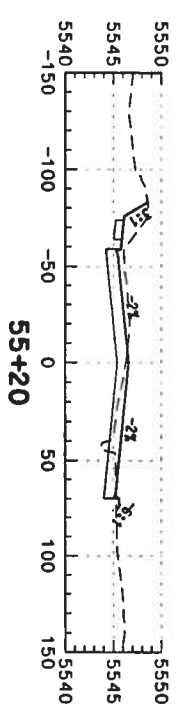
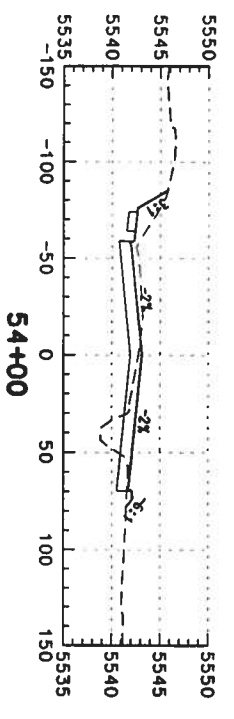
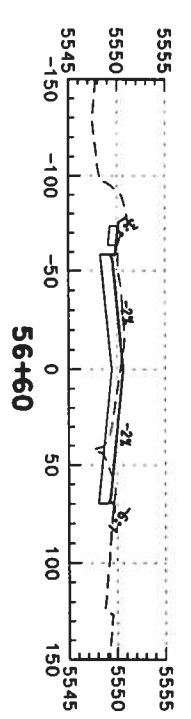
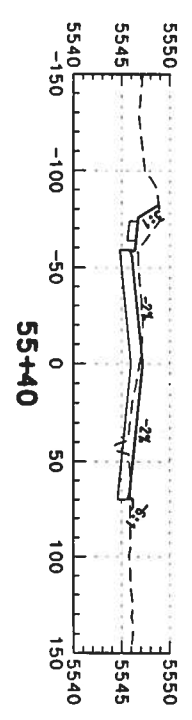
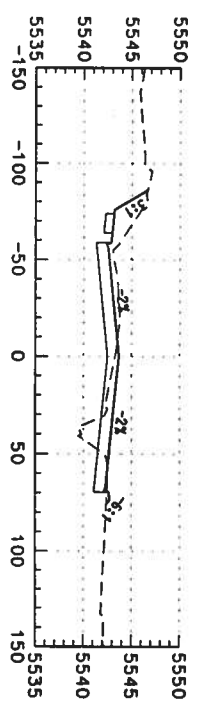
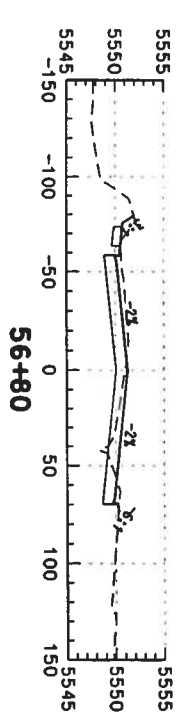
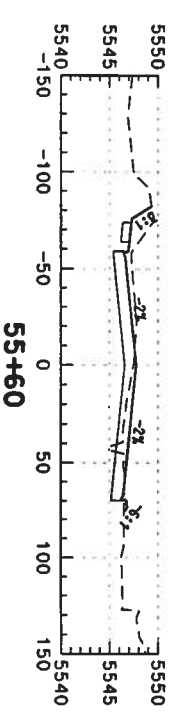
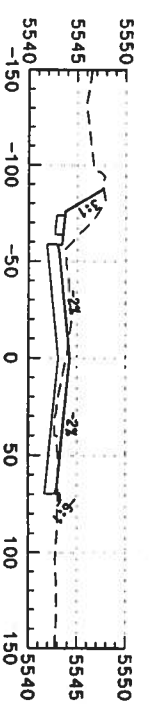
Project No./Code	
NH 0852-086	
Sheet Number:	323



Computer File Information		Index of Revisions						As Constructed		US 85 CROSS SECTIONS		Project No./Code	
Creation Date:	02/14/03	Initials:	DAF			399 Inverness Dr. South	5500 Greenwood Plaza Blvd.	No. Revisions:		Designer:	DAF	NH 0852-086	
Last Modification Date:		Initials:				Suite K	Greenwood Village, CO	Revised:		Detailer:	DAF	13429	
Full Path:	S:\Trampo\246042.12\HwyDes\Plans\					Englewood, CO 80112	Greenwood Village, CO	Void:		Sheet Subset:	Roadway	Sheet Number:	
Drawing File Name:	rdxs-no-24025.dgn					Phone: (303) 790-1020	Phone: 303/221-7275			Subset Sheets:		324	
Scale:	Units: ENGLISH					FAX: (303) 790-1037	Fax: 303/221/7276						

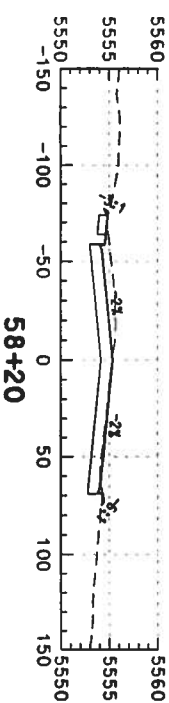
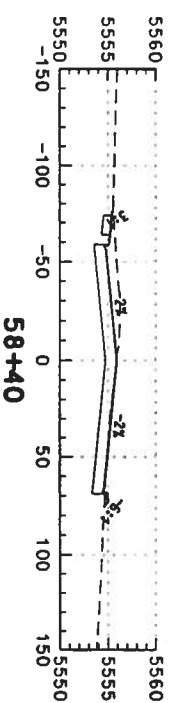
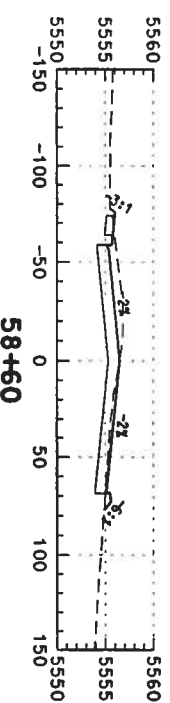
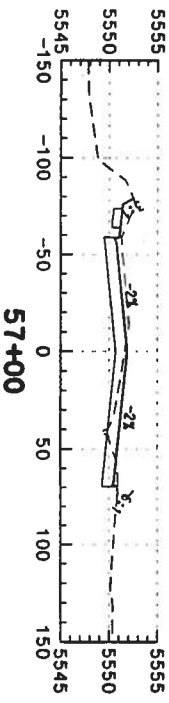
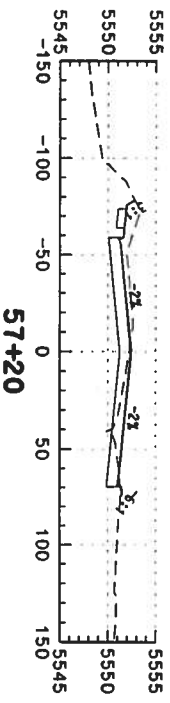
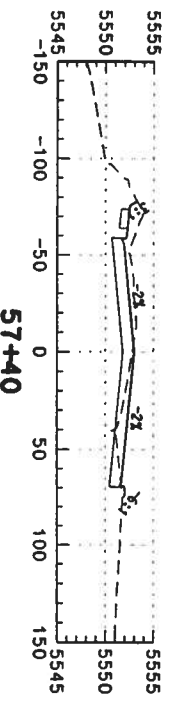
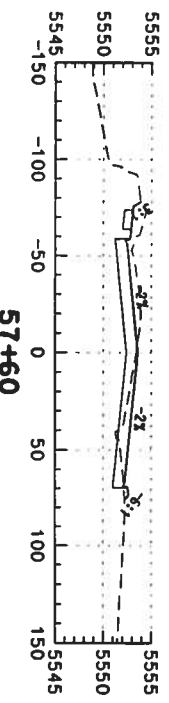
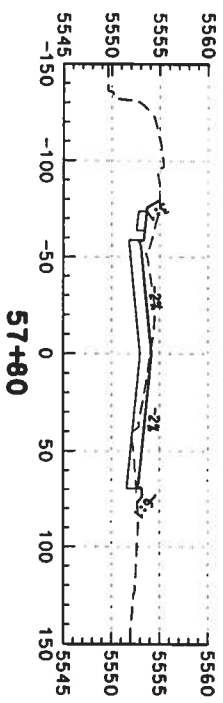
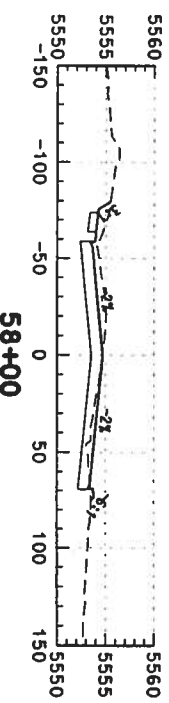

Computer File Information

Creation Date: 02/14/03 Initials: DAF
 Last Modification Date: Initials:
 Full Path: S:\Tranpro\246042\2\HWDes\Plans\ rdxs-no-24026.dgn
 Drawing File Name: Units: ENGLISH
 Scale:

Index of Revisions

No.	Description	Date	By



359 Inverness Dr. South
 Suite K
 Englewood, CO 80120
 Phone: (303) 790-1020
 Fax: (303) 790-1037

REGION 1



5500 Greenwood Plaza Blvd.
 Suite 150
 Greenwood Village, CO 80111
 Phone: 303/221-7275
 Fax: 303/221/7276

As Constructed

No. Revisions:
 Revised:
 Void:

US 85 CROSS SECTIONS

Designer: DAF
 Detailer: DAF
 Sheet Subset: Roadway
 Subset Sheets: of

Project No./Code
 NH 0852-086
 Sheet Number: 13429
 325

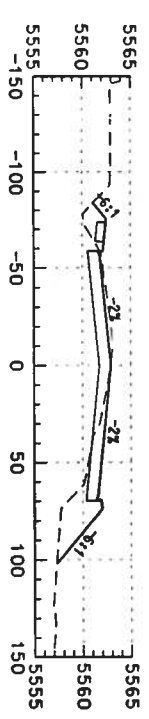
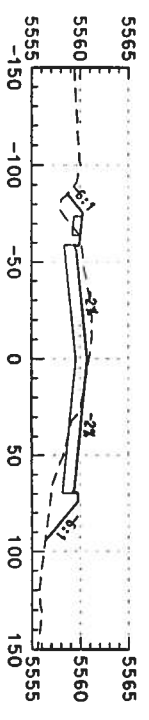
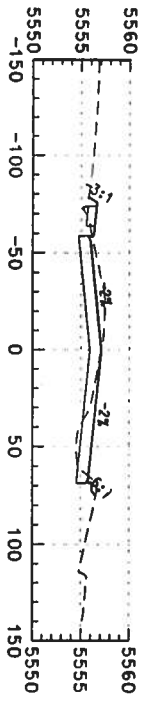
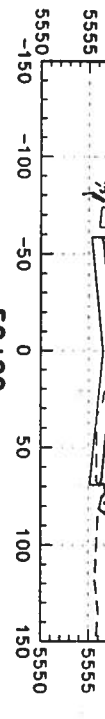
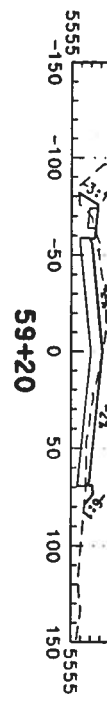
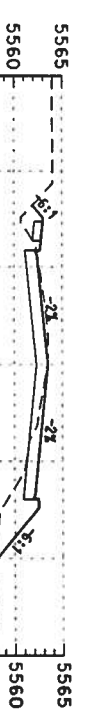
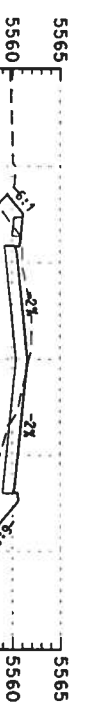
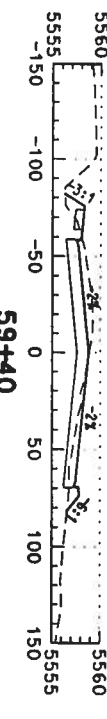
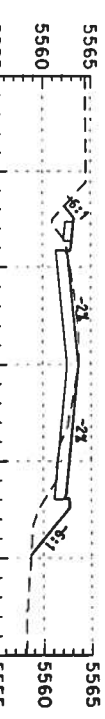
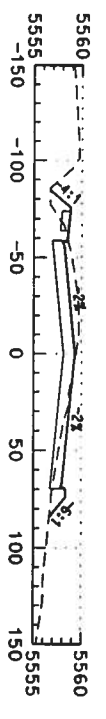
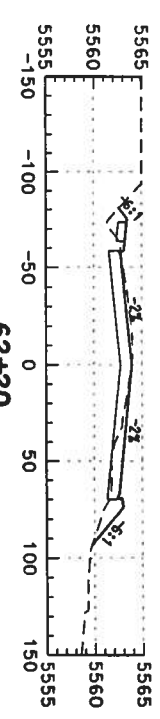
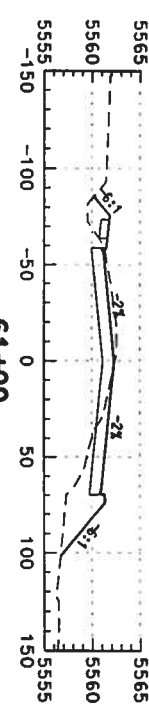
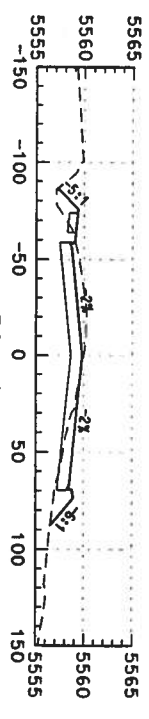
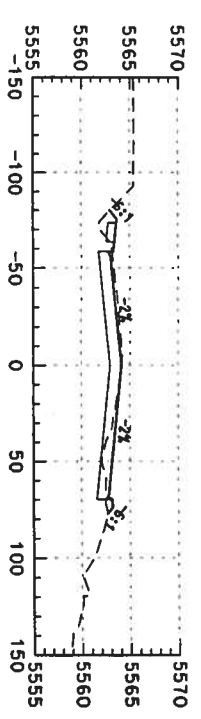
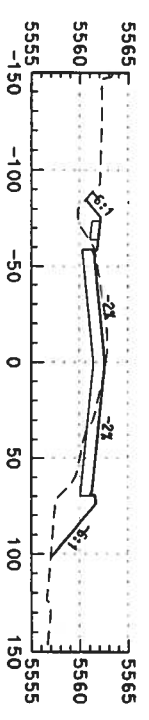
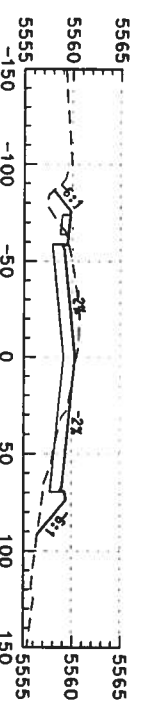

Computer File Information	
Creation Date:	02/14/03
Last Modification Date:	
Initials:	DAF
Full Path:	S:\Transporto\246042.12\HwyDes\Plans\
Drawing File Name:	r dxs-no-2d027.dgn
Scale:	Units: ENGLISH

Index of Revisions	



DOT
DEPARTMENT OF TRANSPORTATION

359 Inverness Dr. South
Suite K
Englewood, CO 80112
Phone: (303) 790-1020
Fax: (303) 790-1057

PBSJ
5500 Greenwood Plaza Blvd.
Suite 150
Greenwood Village, CO 80111
Phone: 303/221-7275
Fax: 303/221/7276

As Constructed	
No. Revisions:	
Revised:	
Void:	

US 85 CROSS SECTIONS	
Designer:	DAF
Detailer:	DAF
Sheet Subset:	Roadway
	Subset Sheets:
	of

Project No./Code	
NH 0852-086	
13429	
Sheet Number:	326

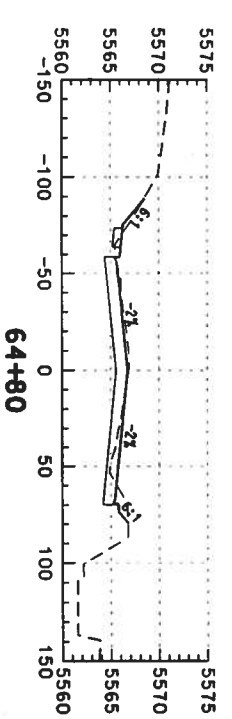
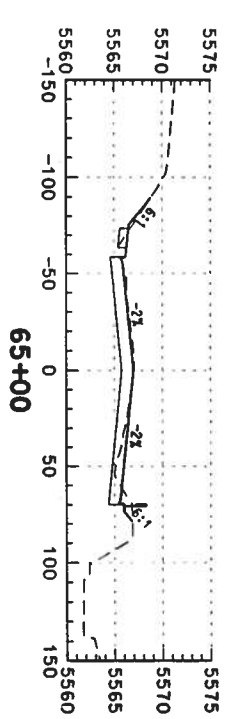
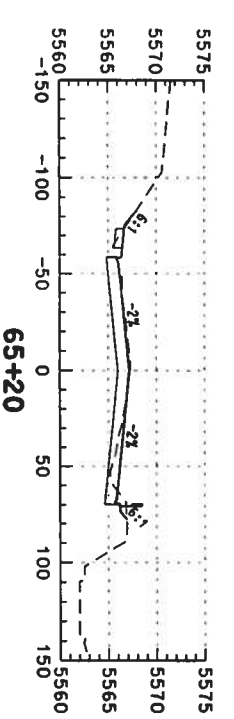
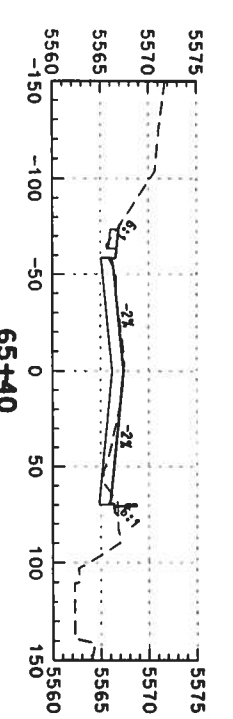
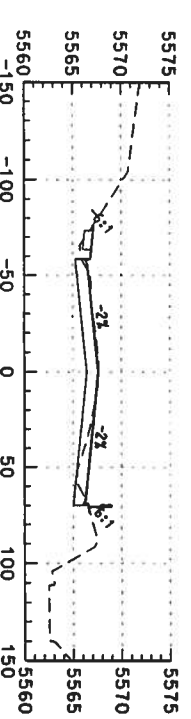
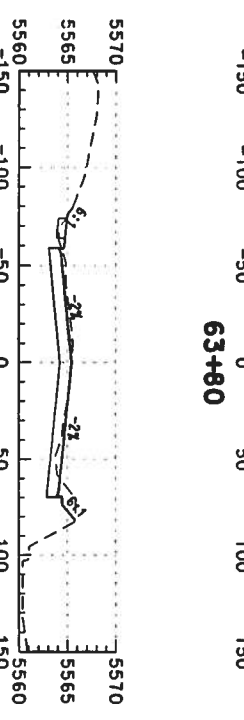
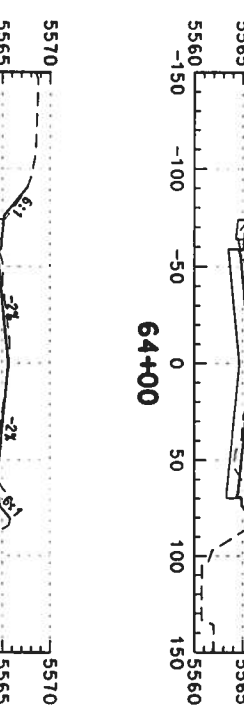
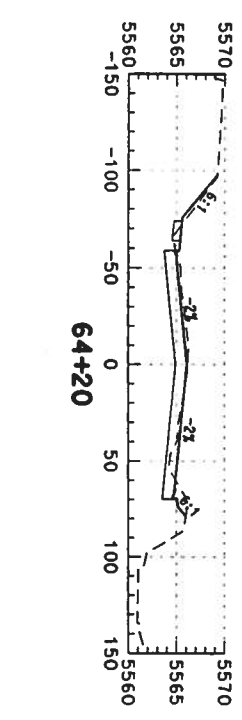
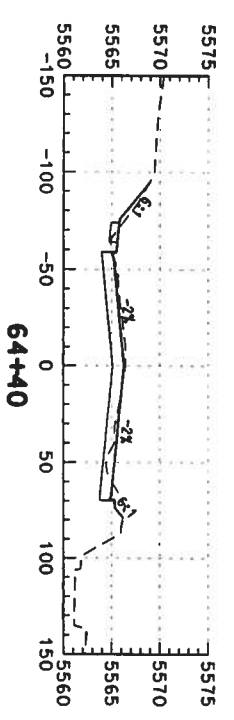
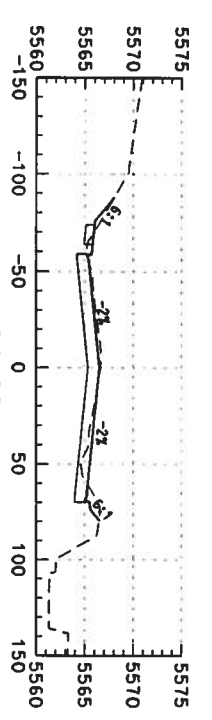
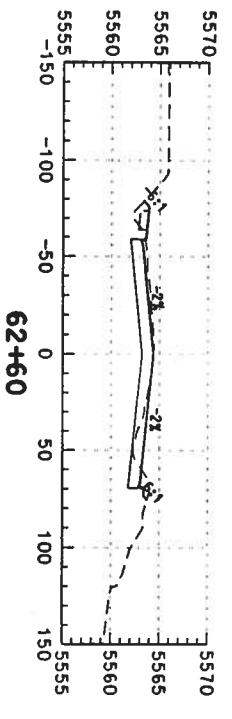
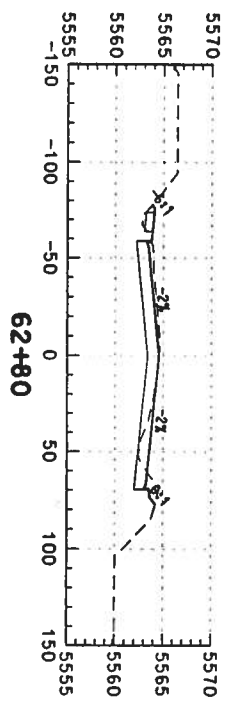
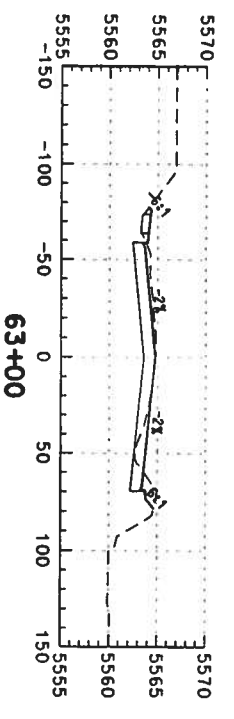
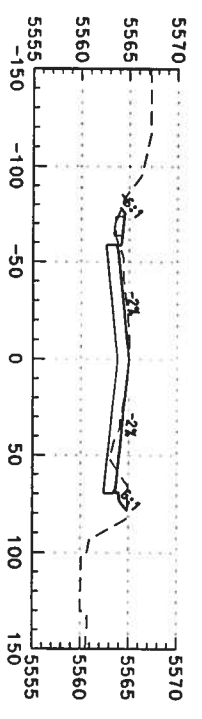
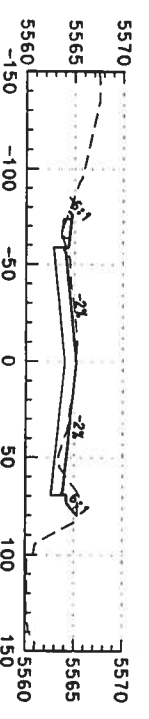

Computer File Information	
Creation Date:	02/14/03
Last Modification Date:	
Full Path:	S:\Tranpro\246042.12\HW\Des\Plans\
Drawing File Name:	rdxs-no-24028.dgn
Scale:	Units: ENGLISH

Index of Revisions	

DOT
DEPARTMENT OF TRANSPORTATION

399 Inverness Dr. South
Suite K
Englewood, CO 80120
Phone: (303) 790-1020
Fax: (303) 790-1037

PBSJ

5500 Greenwood Plaza Blvd.
Suite 150
Greenwood Village, CO 80111
Phone: 303/221-7275
Fax: 303/221/7276

As Constructed	
No. Revisions:	
Revised:	
Void:	

US 85 CROSS SECTIONS	
Designer:	DAF
Detailer:	DAF
Sheet Subset:	Roadway
Structure Numbers:	
Sheet Number:	

Project No./Code	
NH 0852-086	
13429	
Sheet Number:	327

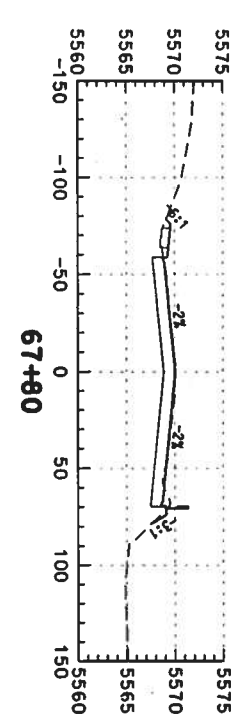
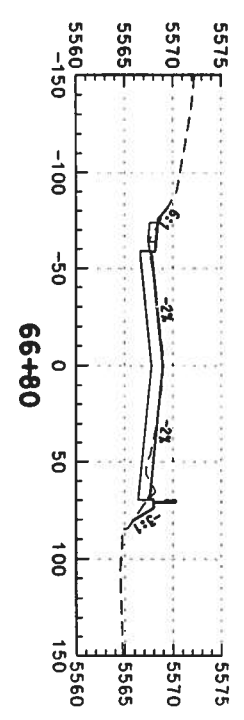
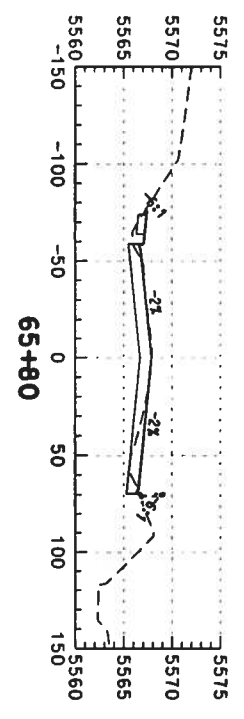
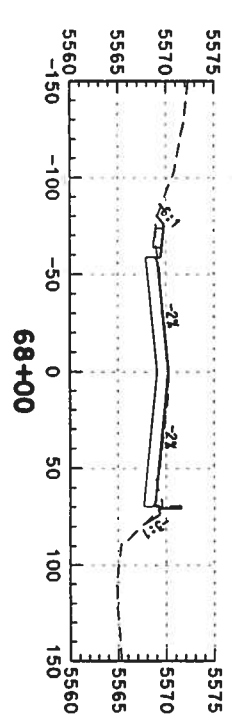
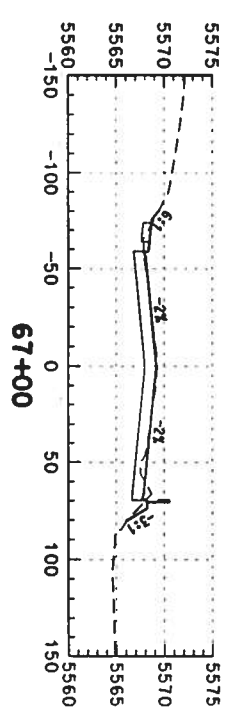
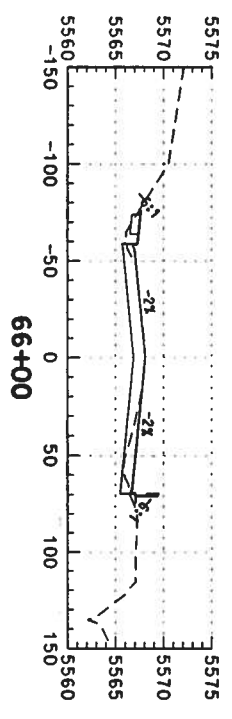
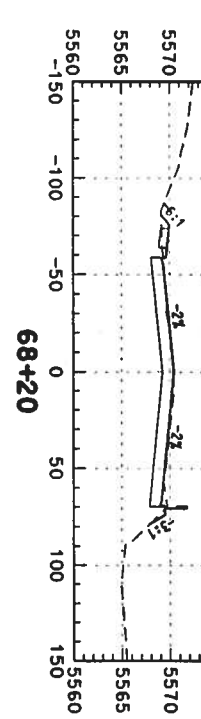
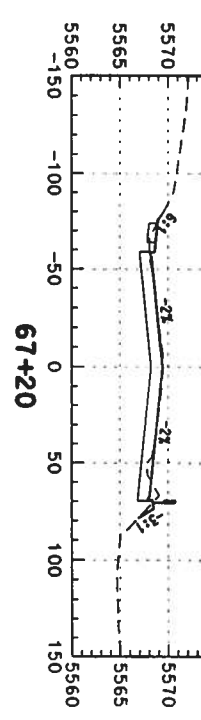
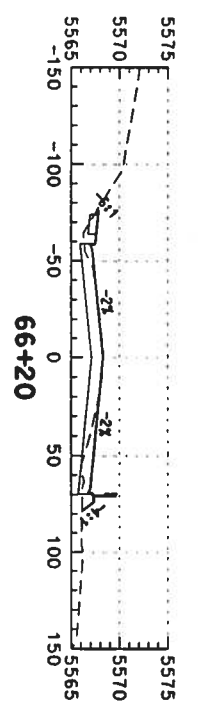
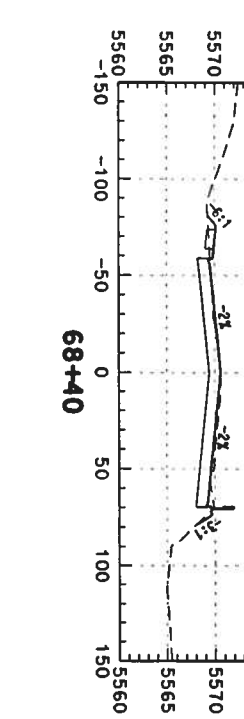
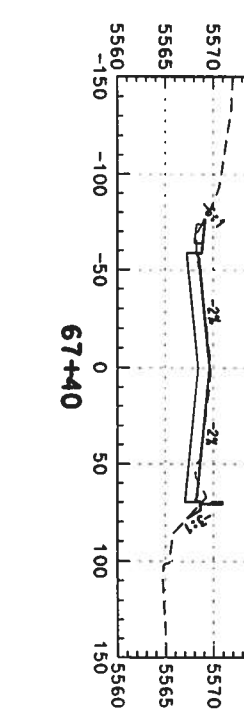
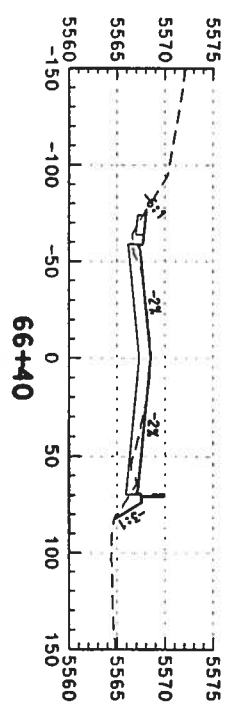
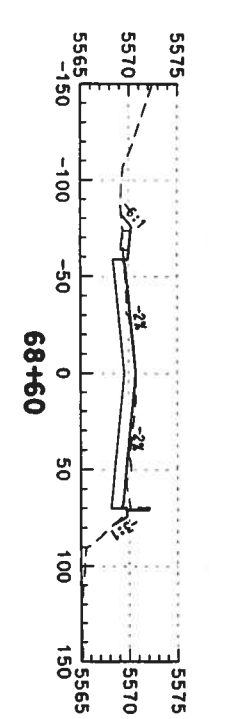
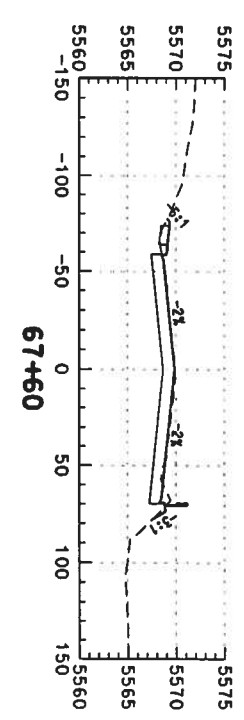
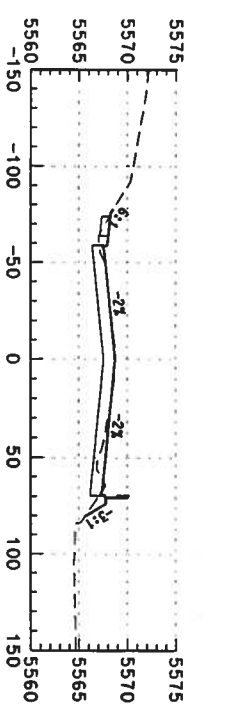

Computer File Information
 Creation Date: 02/14/03 Initials: DAF
 Last Modification Date: Initials:
 Full Path: S:\Tranproj\246042.12\HyDes\Plans\
 Drawing File Name: rdxs-no-2d029.dgn
 Scale: Units: ENGLISH

Index of Revisions

DOT
 DEPARTMENT OF TRANSPORTATION
 339 Inverness Dr. South
 Suite K
 Englewood, CO 80112
 Phone: (303) 790-1020
 FAX: (303) 790-1037

PBSJ
 5500 Greenwood Plaza Blvd.
 Suite 150
 Greenwood Village, CO 80111
 Phone: 303/221-7275
 Fax: 303/221/7276

As Constructed
 No. Revisions:
 Revised:
 Void:

US 85 CROSS SECTIONS
 Designer: DAF
 Detailer: DAF
 Sheet Subset: Roadway
 Subset Sheets: of

Project No./Code
 NH 0852-086
 13429
 Sheet Number: 328

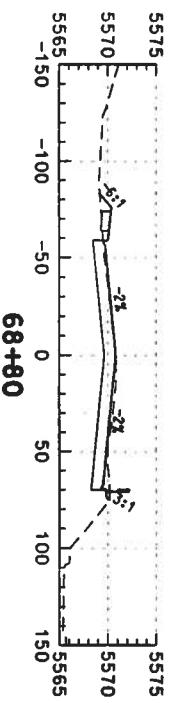
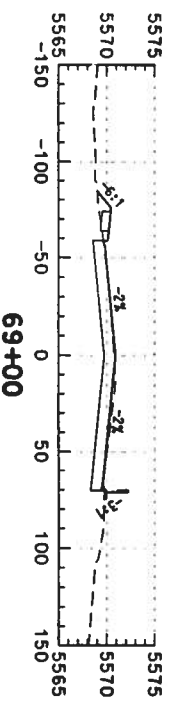
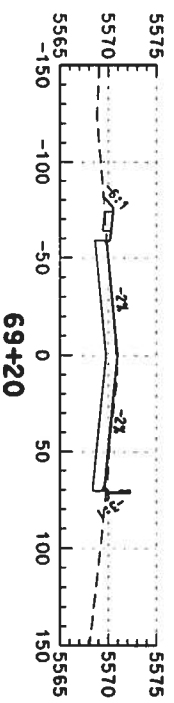

Computer File Information
 Creation Date: 02/14/03 Initials: DAF
 Last Modification Date: Initials:
 Full Path: S:\Tranpro\246042\246042\HwyDes\Plans\
 Drawing File Name: rdxs-no-24030.dgn
 Scale: Units: ENGLISH

Index of Revisions



359 Inverness Dr. South
 Suite K
 Englewood, CO 80112
 Phone: (303) 790-1020
 Fax: (303) 790-1037

REGION 1



5500 Greenwood Plaza Blvd.
 Suite 150
 Greenwood Village, CO 80111
 Phone: 303/221-7275
 Fax: 303/221/7276

As Constructed

No. Revisions:
 Revised:
 Void:

US 85 CROSS SECTIONS

Designer: DAF
 Detailer: DAF
 Sheet Subset: Roadway
 Structure Numbers
 Subset Sheets: of

Project No./Code
 NH 0852-086
 Sheet Number: 13429
 329

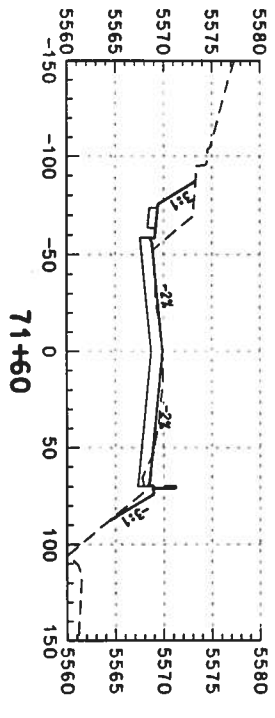
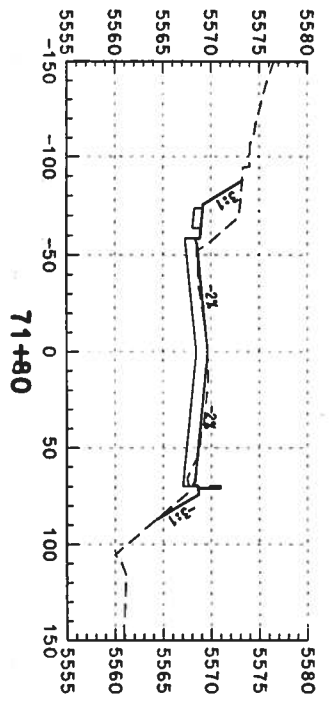
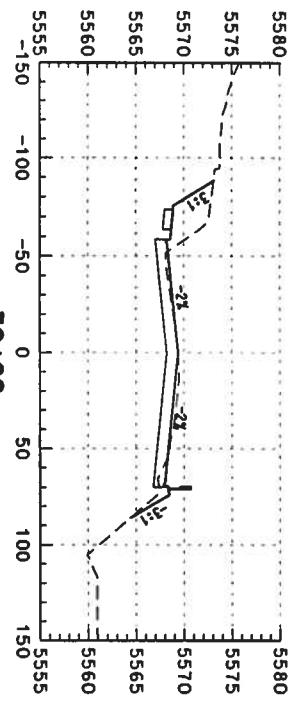
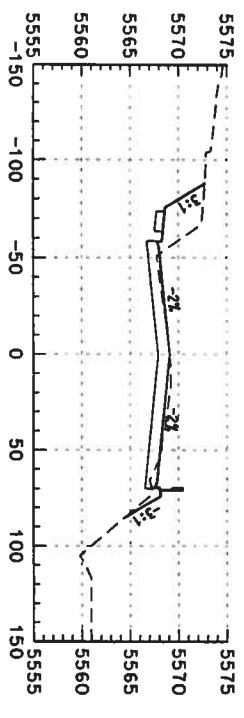
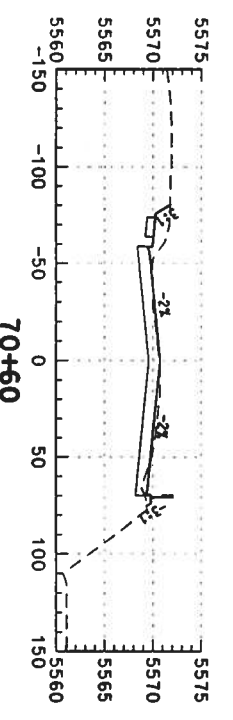
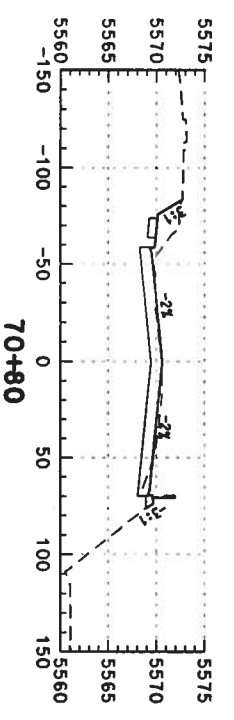
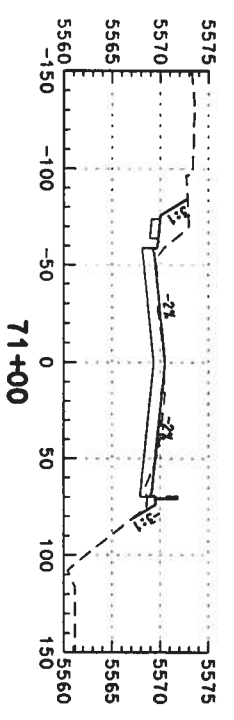
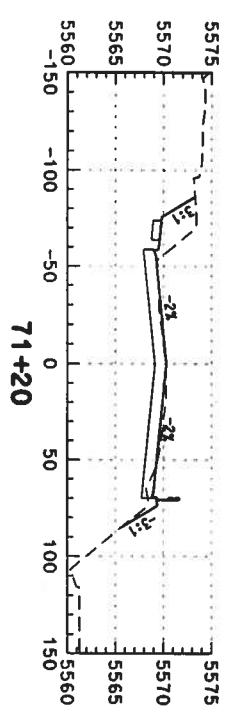
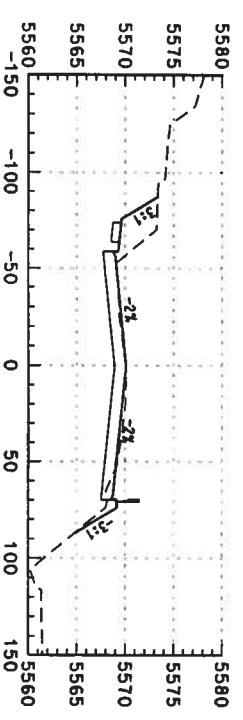
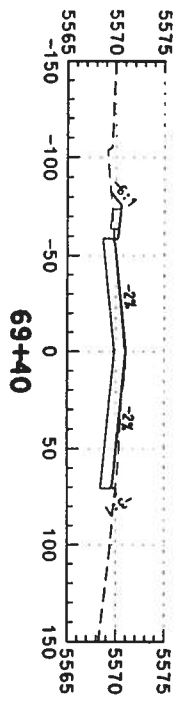
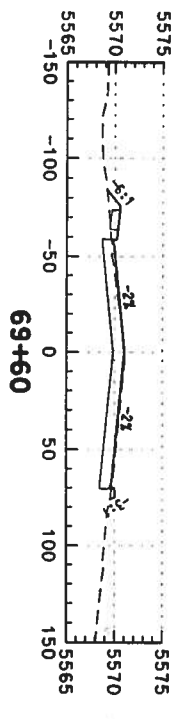
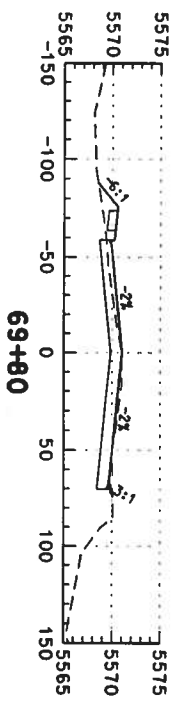
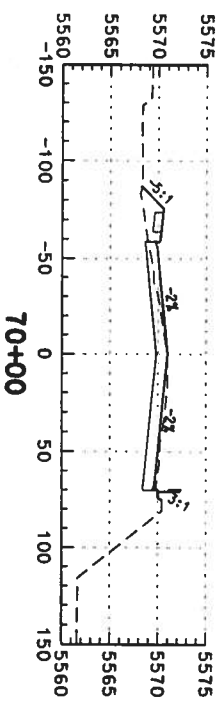
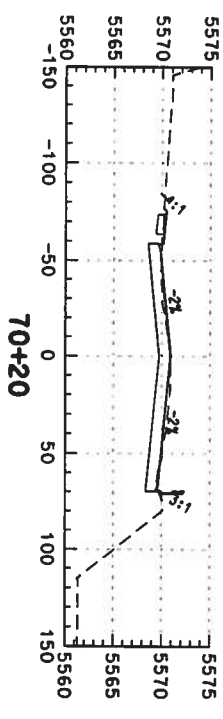
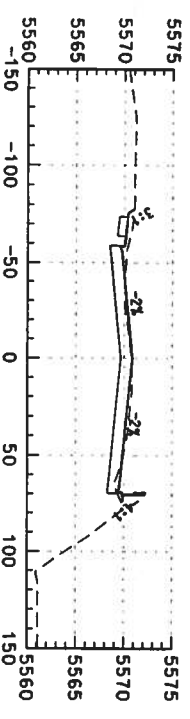

Computer File Information

Creation Date: 02/14/03 Initials: DAF
 Last Modification Date: Initials:
 Full Path: S:\Tranpro\246042\2\HwyDes\Plans\
 Drawing File Name: rdxs-no-24031.dgn
 Scale: Units: ENGLISH

Index of Revisions



359 Inverness Dr. South
 Suite K
 Englewood, CO 80112
 Phone: (303) 790-1020
 Fax: (303) 790-1037

REGION I



5500 Greenwood Plaza Blvd.
 Suite 150
 Greenwood Village, CO 80111
 Phone: 303/221-7275
 Fax: 303/221/7276

As Constructed

No. Revisions:
 Revised:
 Void:

US 85 CROSS SECTIONS

Designer: DAF Structure
 Detailer: DAF Numbers
 Sheet Subset: Roadway Subset Sheets: of

Project No./Code

NH 0852-086
 13429
 Sheet Number: 330

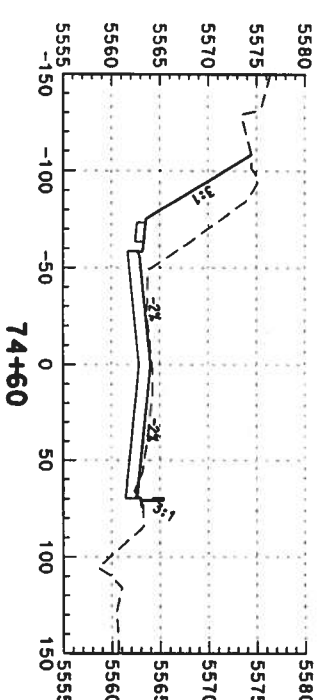
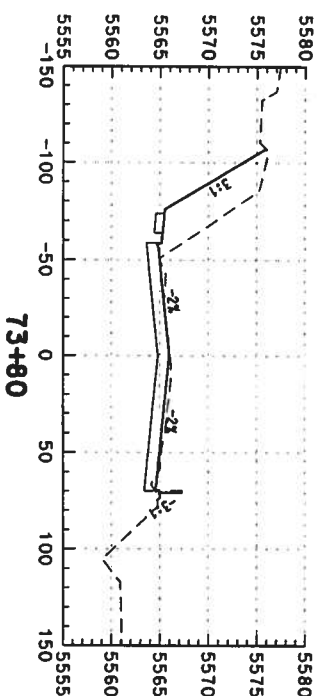
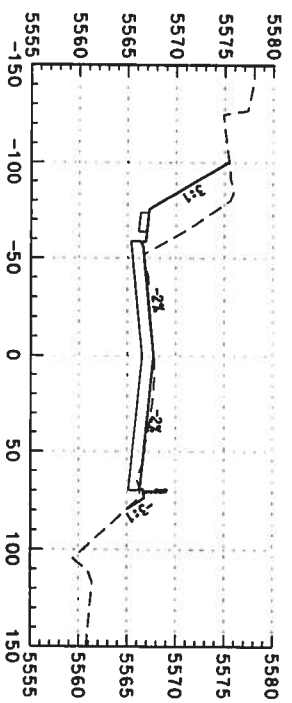

73+00

73+80

74+60

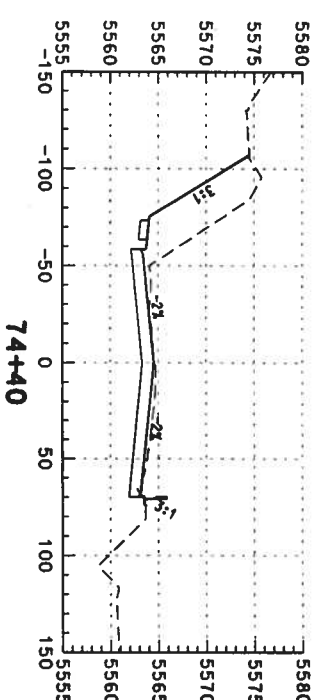
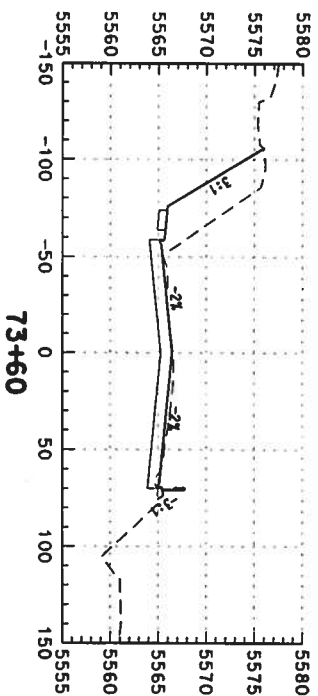
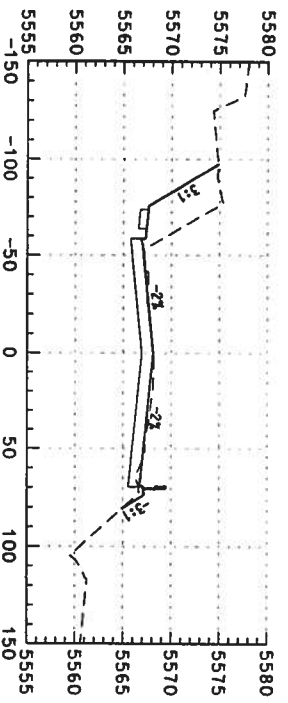

72+80

73+60

74+40

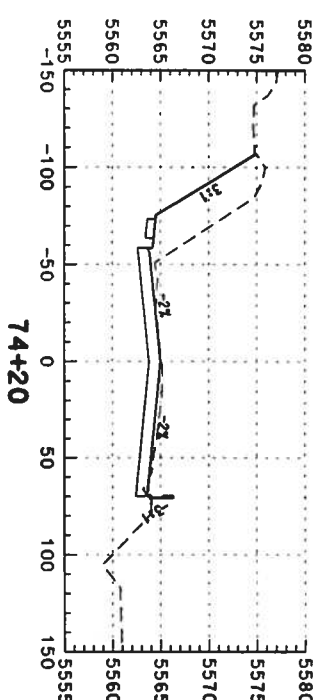
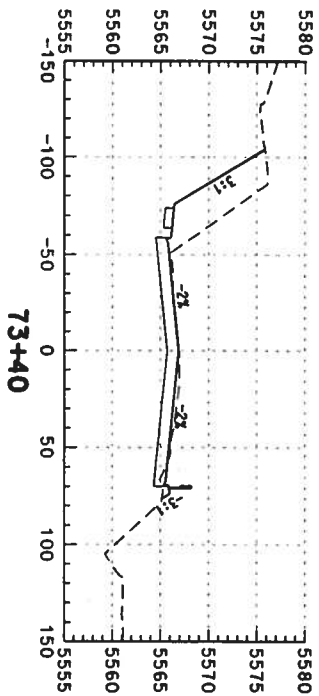
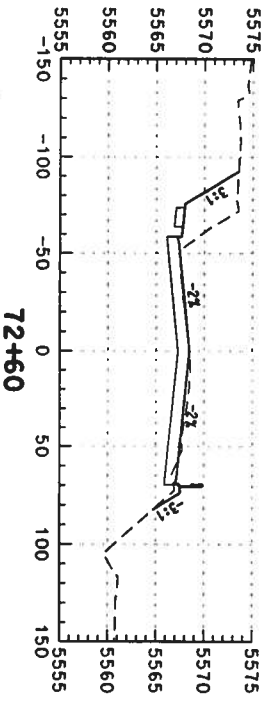

72+60

73+40

74+20

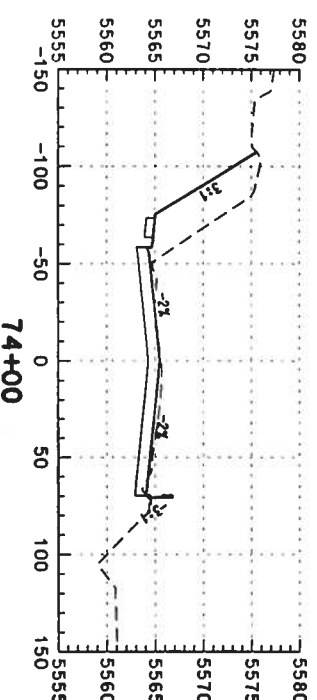
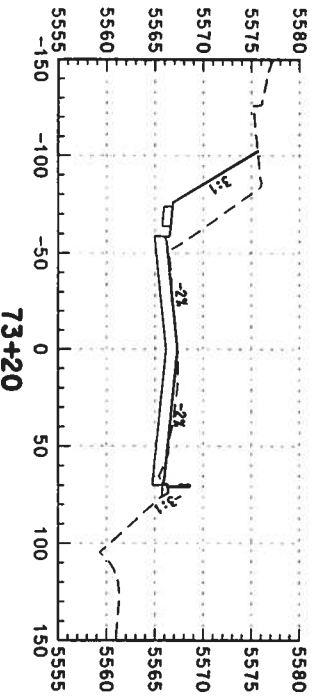
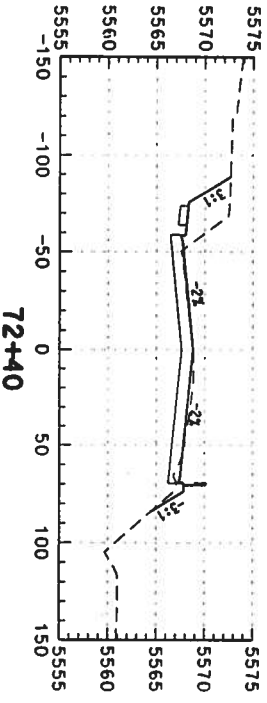

72+40

73+20

74+00

Computer File Information

Creation Date: 02/14/03 Initials: DAF
 Last Modification Date: Initials:
 Full Path: S:\Trompro\246042\HWYDes\Plans\
 Drawing File Name: rdxs-no-2d032.dgn
 Scale: Units: ENGLISH

Index of Revisions



REGION 1
 359 Inverness Dr. South
 Suite K
 Englewood, CO 80112
 Phone: (303) 790-1020
 FAX: (303) 790-1037



5500 Greenwood Plaza Blvd.
 Suite 150
 Greenwood Village, CO 80111
 Phone: 303/221-7275
 Fax: 303/221/7276

As Constructed

No. Revisions: _____
 Revised: _____
 Void: _____

US 85 CROSS SECTIONS

Designer: DAF Structure
 Detailer: DAF Numbers
 Sheet Subset: Roadway Subset Sheets: _____ of _____

Project No./Code

NH 0852-086
 13429
 Sheet Number: 331

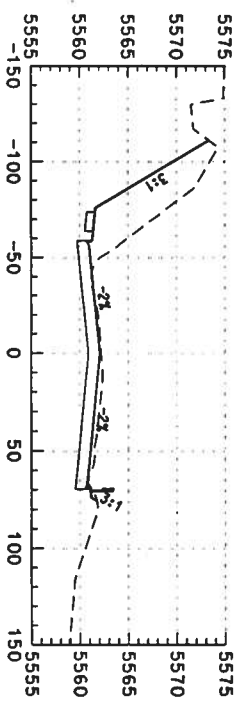

75+40



75+20



75+00

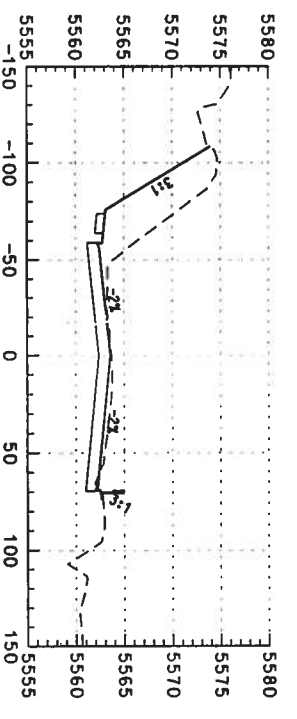

74+80

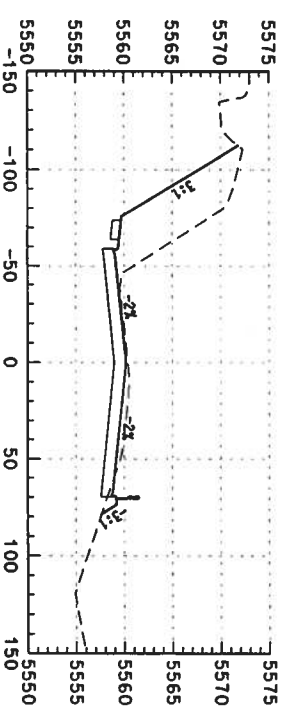

76+20

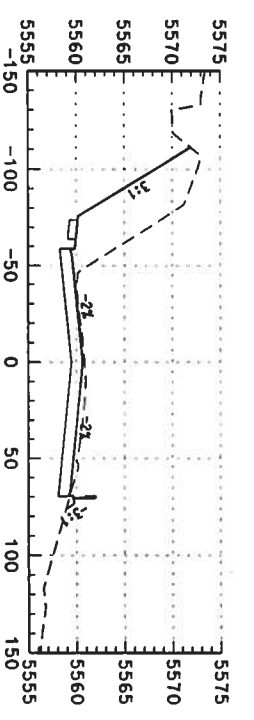

76+00

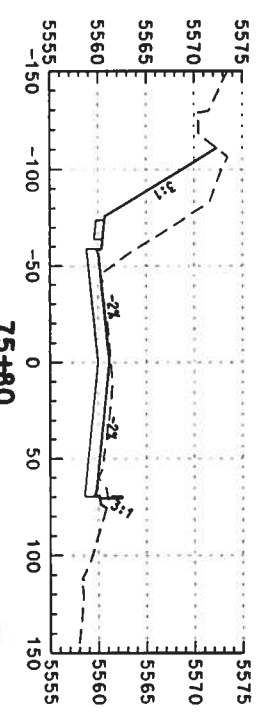

75+80

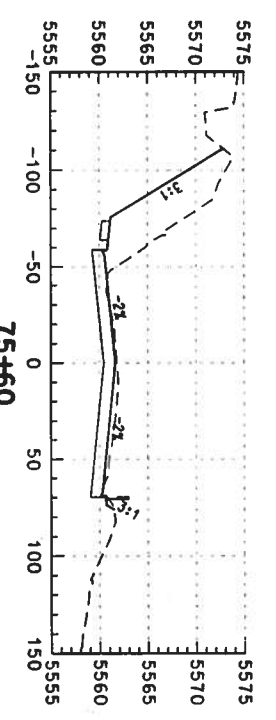

75+60

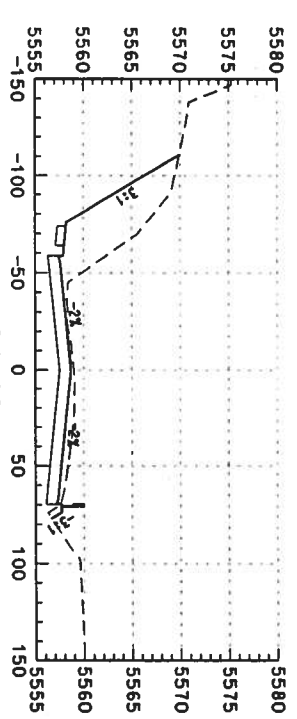

76+82

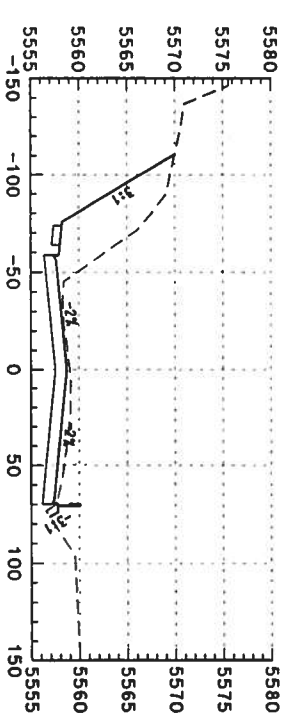

76+80

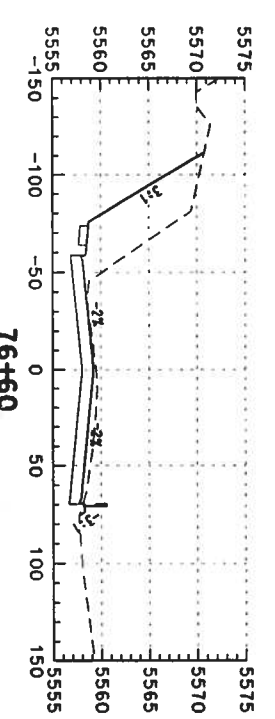

76+60

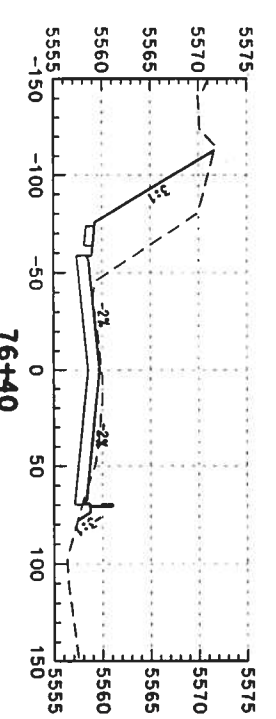

76+40

Computer File Information
 Creation Date: 02/14/03 Initials: DAF
 Last Modification Date: Initials:
 Full Path: S:\Tranproj\246042\12\Hydes\Plans\
 Drawing File Name: rdxs-no-2d033.dgn
 Scale: Units: ENGLISH

Index of Revisions

DOT
 DEPARTMENT OF TRANSPORTATION
 REGION 1
 358 Inverness Dr. South
 Suite K
 Englewood, CO 80112
 Phone: (303) 790-1020
 Fax: (303) 790-1037

PBSJ
 5500 Greenwood Plaza Blvd.
 Suite 150
 Greenwood Village, CO 80111
 Phone: 303/221-7275
 Fax: 303/221/7276

As Constructed

No. Revisions:	
Revised:	
Void:	

US 85 CROSS SECTIONS
 Designer: DAF Structure
 Detailer: DAF Numbers
 Sheet Subset: Roadway Subset Sheets: of

Project No./Code
 NH 0852-086
 13429
 Sheet Number: 332

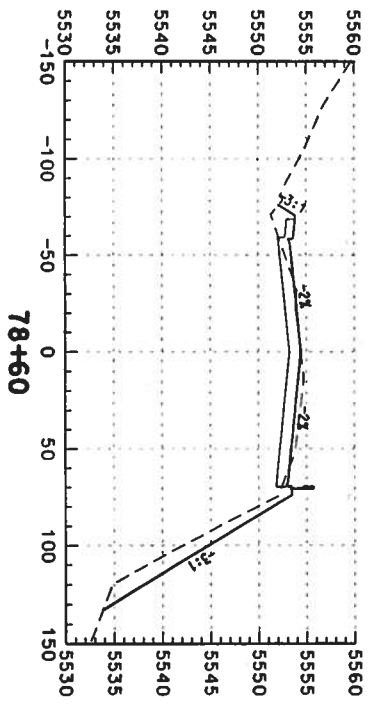
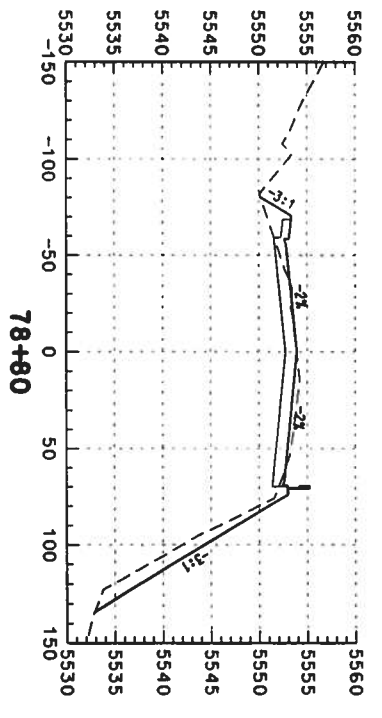
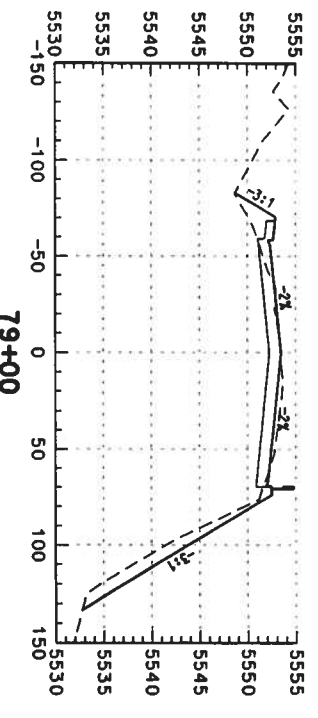
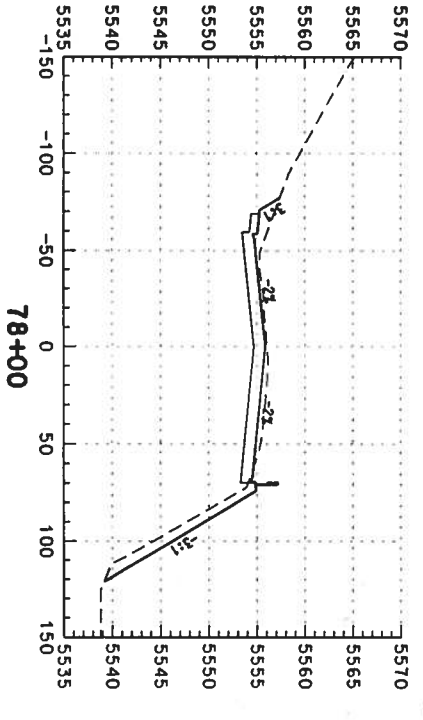
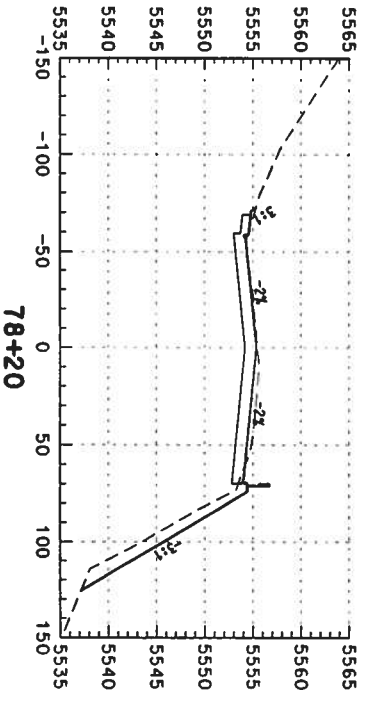
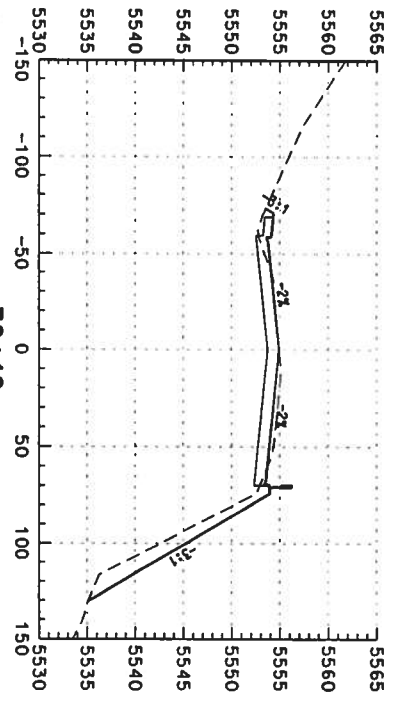
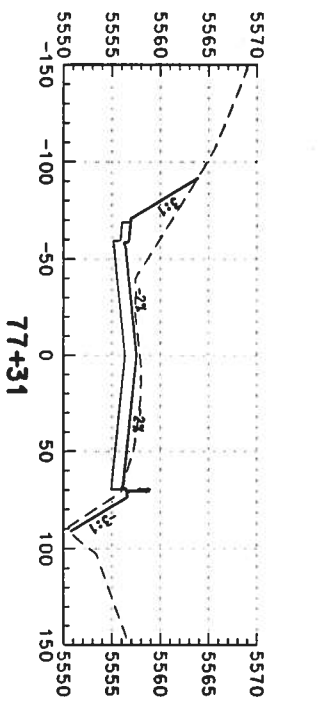
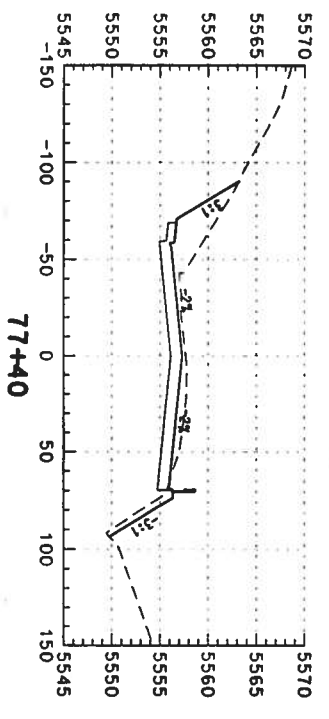
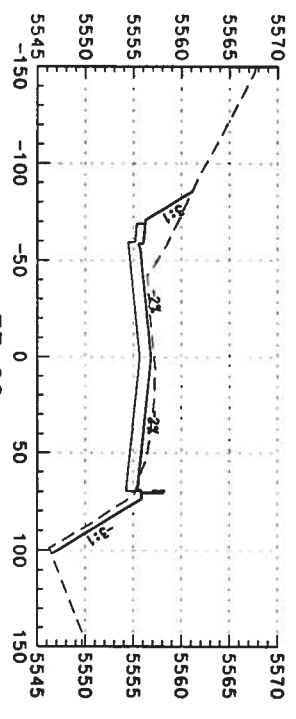
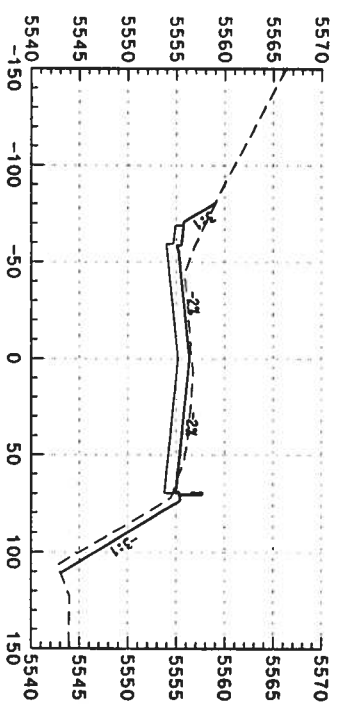

Computer File Information

Creation Date:	02/14/03	Initials:	DAF
Last Modification Date:		Initials:	
Full Path:	S:\Transport\246042\246042\HwyDes\Plans\rdxs-no-20034.dgn		
Drawing File Name:	rdxs-no-20034.dgn		
Scale:	Units: ENGLISH		

Index of Revisions



DOT
DEPARTMENT OF TRANSPORTATION

359 Inverness Dr. South
Suite K
Englewood, CO 80112
Phone: (303) 790-1020
Fax: (303) 790-1037

REGION 1



PBSJ

5500 Greenwood Plaza Blvd.
Suite 150
Greenwood Village, CO 80111
Phone: 303/221-7275
Fax: 303/221-7276

As Constructed

No. Revisions:	
Revised:	
Void:	

US 85 CROSS SECTIONS

Designer:	DAF	Structure	
Detailer:	DAF	Numbers	
Sheet Subset:	Roadway	Subset Sheets:	

Project No./Code

NH 0852-086

13429

Sheet Number: 333 of

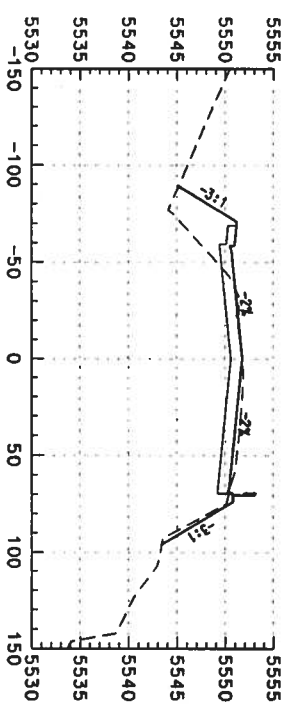

79+80

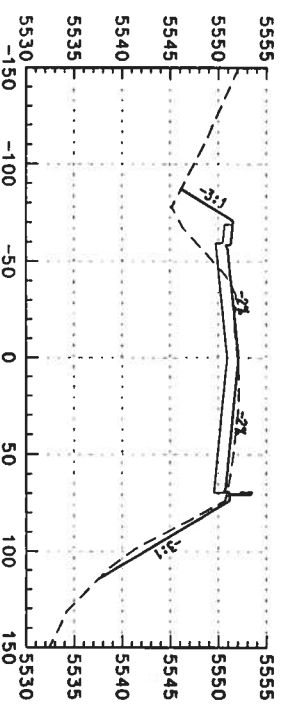

79+60

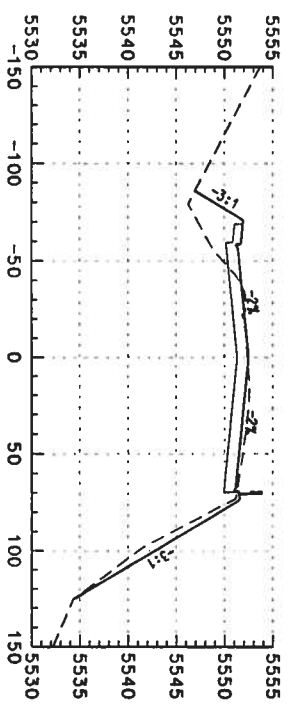

79+40

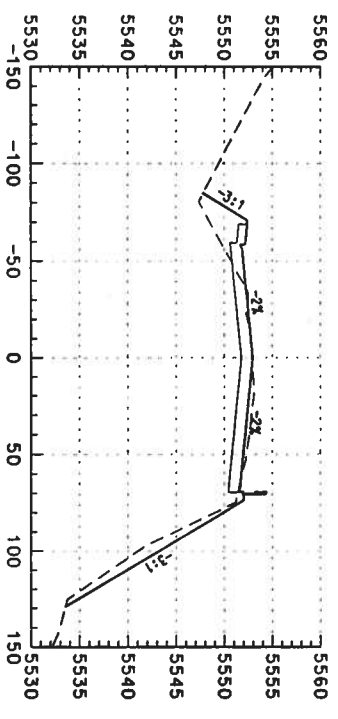

79+20

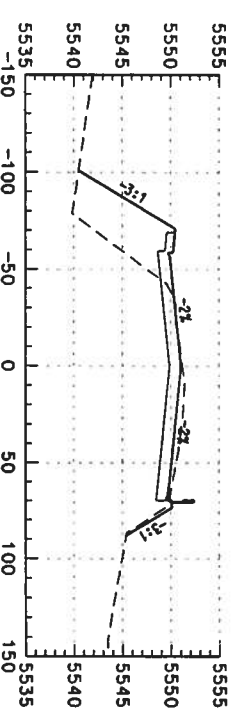

80+80

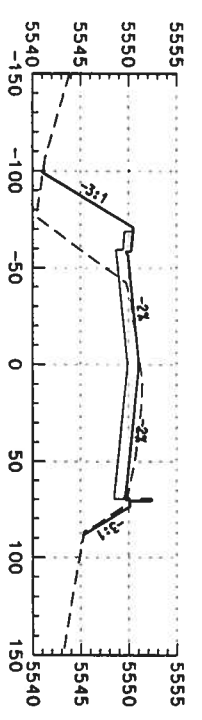

80+60

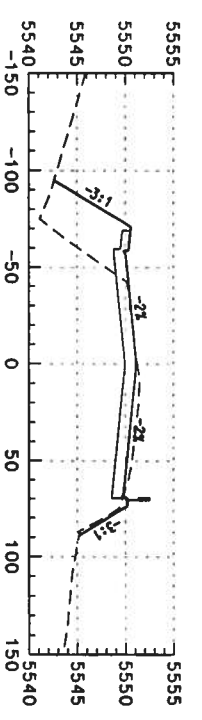

80+40

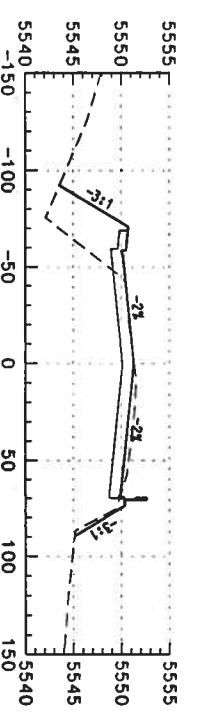

80+20

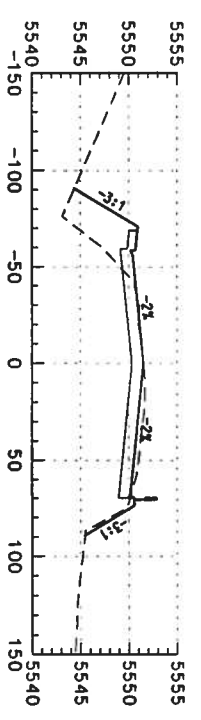

80+00

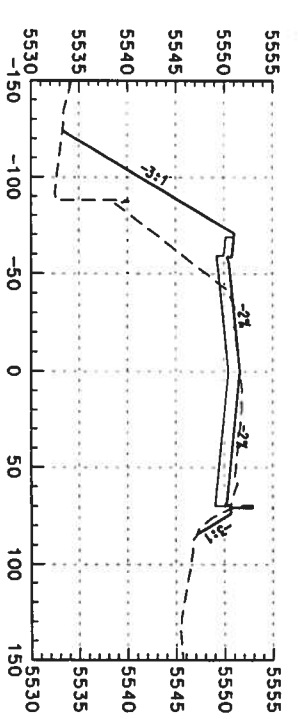

81+60

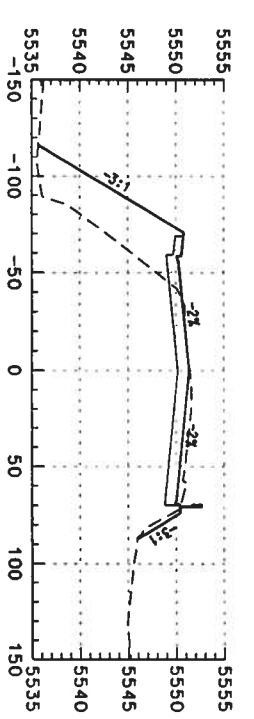

81+40

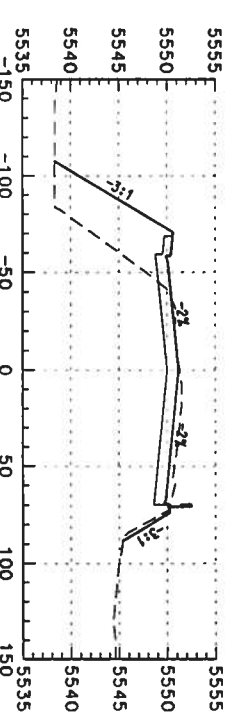

81+20

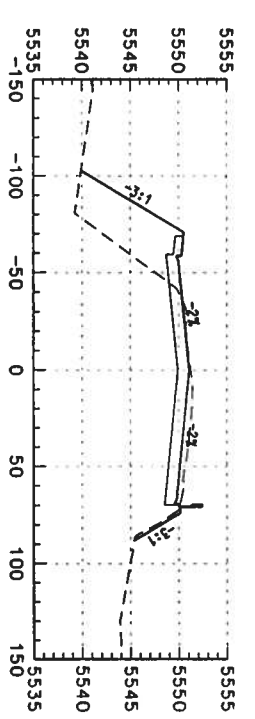

81+00

Computer File Information

Creation Date: 02/14/03 Initials: DAF
 Lost Modification Date: Initials:
 Full Path: S:\Tranpro\246042\12\HyDes\Plans\
 Drawing File Name: rdxs-no-2d035.dgn
 Scale: Units: ENGLISH

Index of Revisions



359 Inverness Dr. South
 Suite K
 Englewood, CO 80112
 Phone: (303) 790-1020
 FAX: (303) 790-1037



5500 Greenwood Plaza Blvd.
 Suite 150
 Greenwood Village, CO 80111
 Phone: 303/221-7275
 Fax: 303/221/7276

As Constructed

No. Revisions:	
Revised:	
Void:	

US 85 CROSS SECTIONS

Designer:	DAF	Structure	
Detailer:	DAF	Numbers	
Sheet Subset:	Roadway	Subset Sheets:	

Project No./Code: NH 0852-086
 Sheet Number: 334

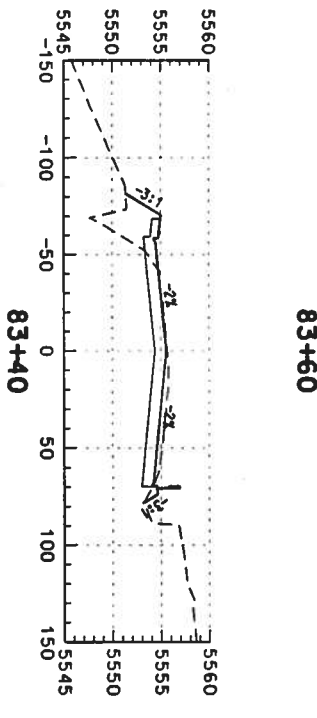
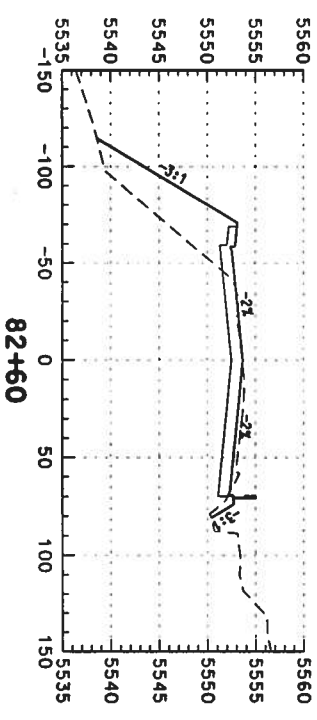
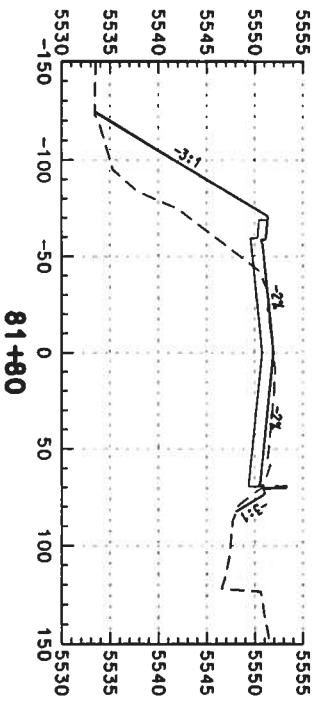
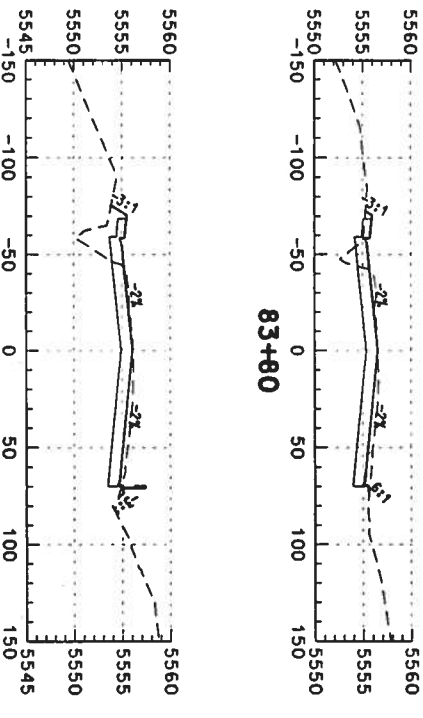
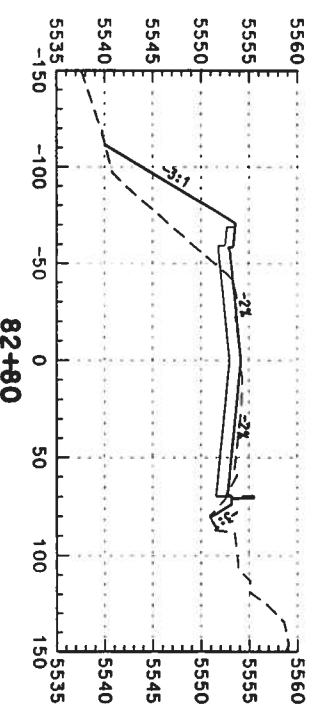
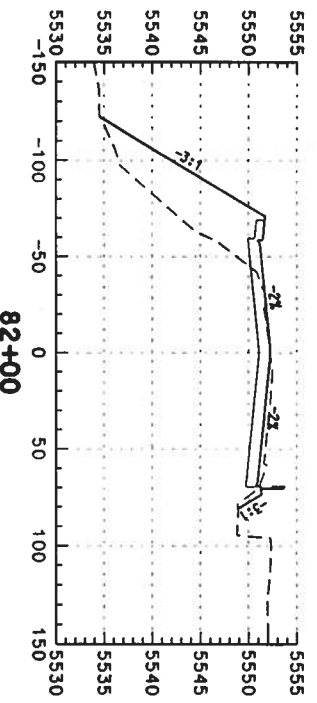
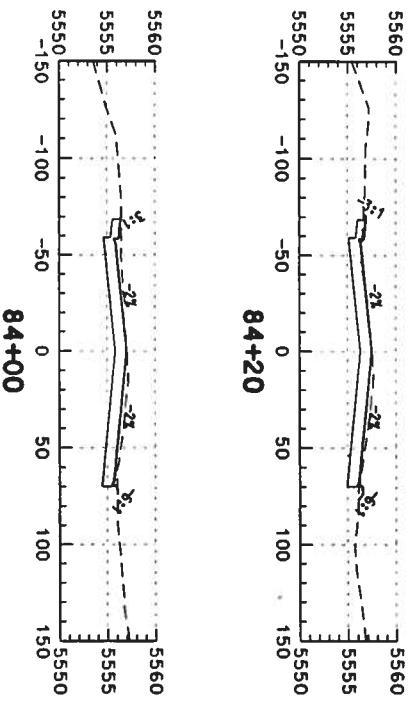
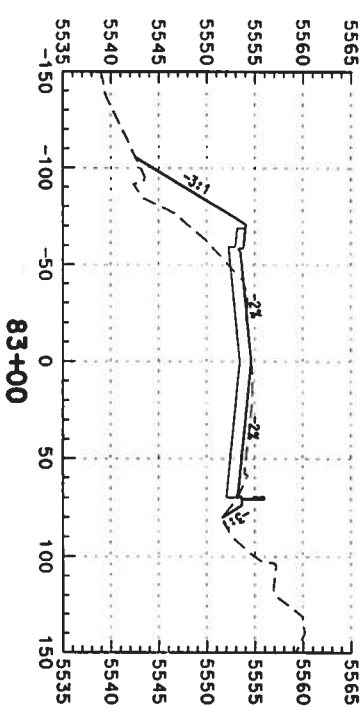
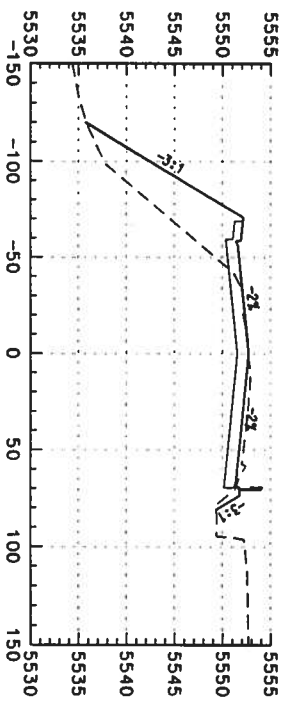
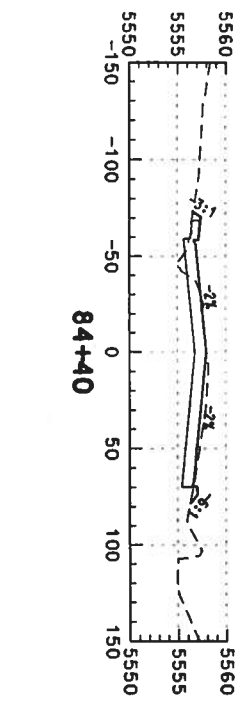
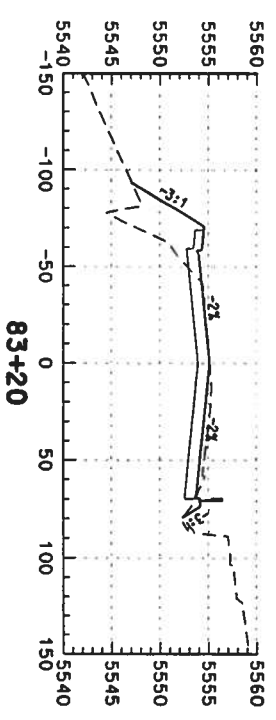
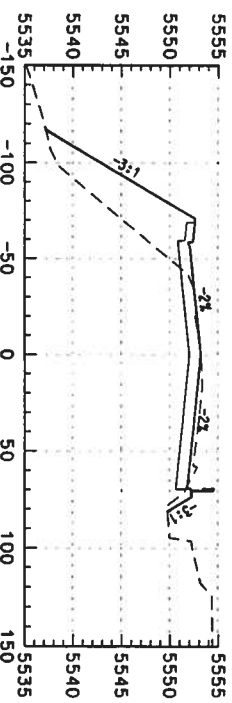

Computer File Information

Creation Date: 02/14/03 Initials: DAF
 Last Modification Date: Initials:
 Full Path: S:\Temp\proj\246042\HW\Des\Plans\
 Drawing File Name: rdxs-no-24036.dgn
 Scale: Units: ENGLISH

Index of Revisions



359 Inverness Dr. South
 Suite K
 Englewood, CO 80112
 Phone: (303) 790-1020
 Fax: (303) 790-1037



5500 Greenwood Plaza Blvd.
 Suite 150
 Greenwood Village, CO 80111
 Phone: 303/221-7275
 Fax: 303/221-7276

As Constructed

No. Revisions:	
Revised:	
Void:	

US 85 CROSS SECTIONS

Designer:	DAF	Structure	
Detailer:	DAF	Numbers	
Sheet Subset:	Roadway	Subset Sheets:	

Project No./Code
 NH 0852-086

Sheet Number:
 13429
 of 335

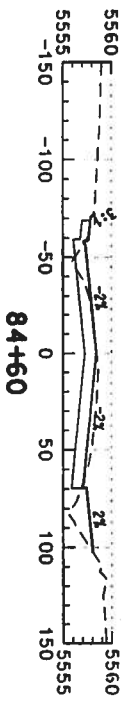
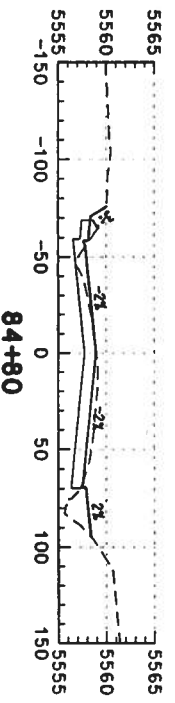
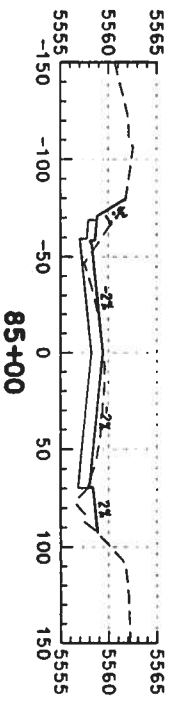
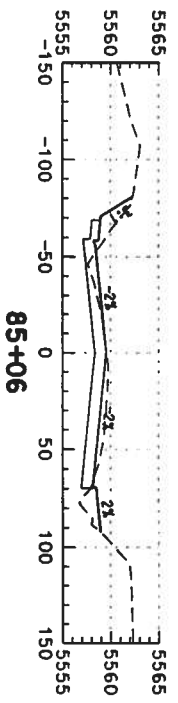

Computer File Information	
Creation Date:	02/14/03
Last Modification Date:	02/14/03
Full Path:	S:\Temp\246042.HwyDes\Plans\
Drawing File Name:	rdxs-no-24037.dgn
Scale:	Units: ENGLISH

Index of Revisions	

DOT
DEPARTMENT OF TRANSPORTATION

359 Inverness Dr. South
Suite K
Englewood, CO 80112
Phone: (303) 790-1020
Fax: (303) 790-1037

REGION 1

PBSJ

5500 Greenwood Plaza Blvd.
Suite 150
Greenwood Village, CO 80111
Phone: 303/221-7275
Fax: 303/221/7276

As Constructed	
No. Revisions:	
Revised:	
Void:	

US 85 CROSS SECTIONS	
Designer:	DAF
Detailer:	DAF
Sheet Subset:	Roadway
Structure Numbers	
Subset Sheets:	
	of

Project No./Code	
NH 0852-086	
Sheet Number:	336

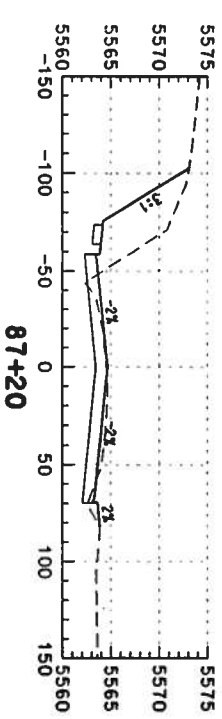
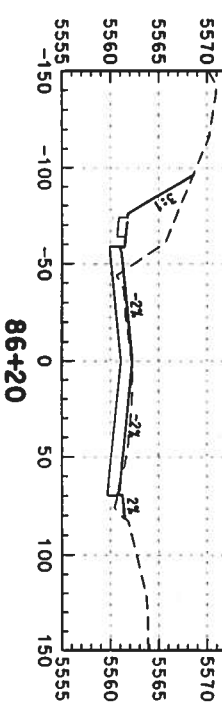
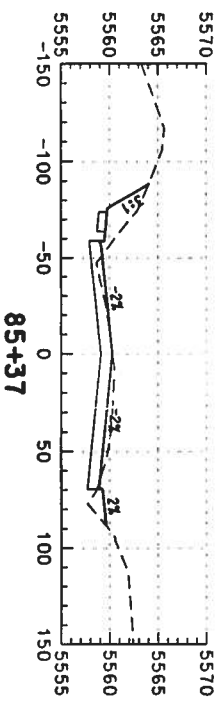
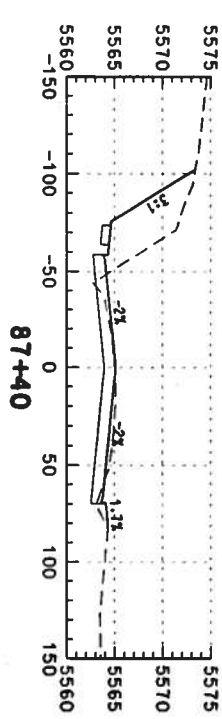
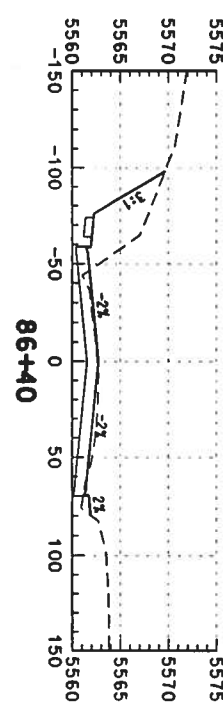
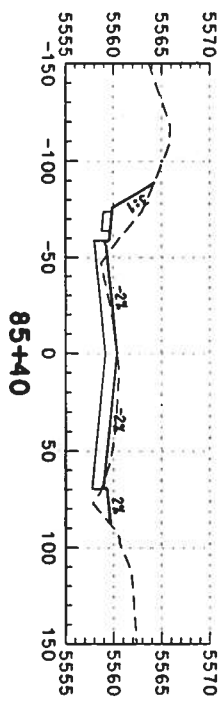
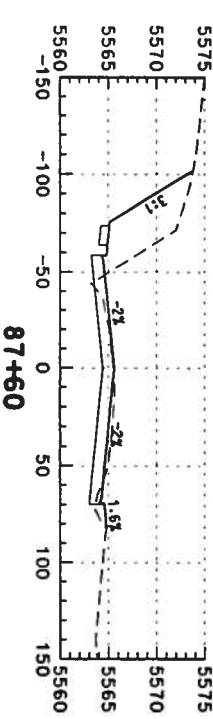
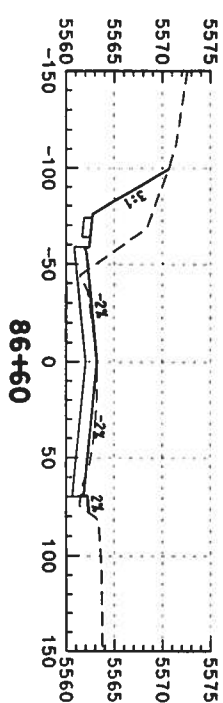
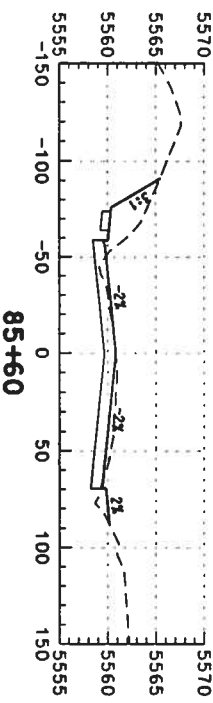
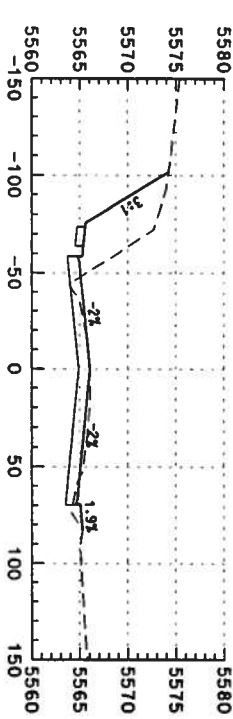
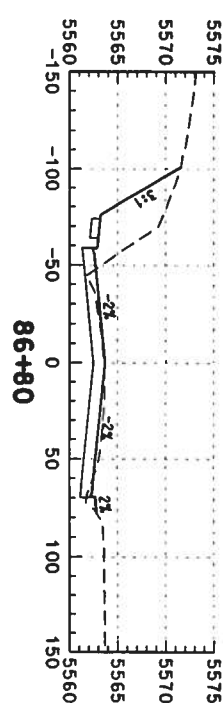
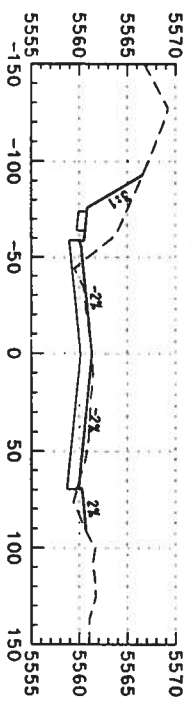
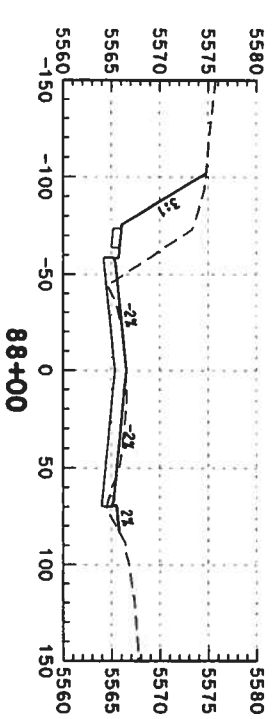
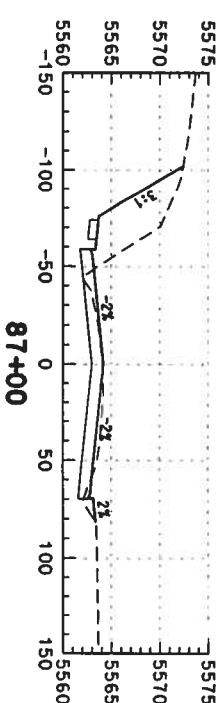
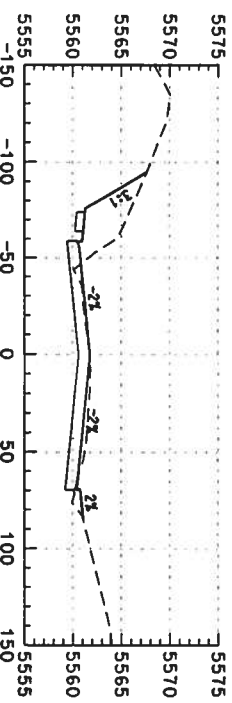

Computer File Information

Creation Date:	02/14/03	Initials:	DAF
Lost Modification Date:		Initials:	
Full Path:	S:\Transport\246042\246042\HwyDes\Plans\		
Drawing File Name:	r_dxs-no-24038.dgn		
Scale:	Units: ENGLISH		

Index of Revisions



359 Inverness Dr. South
Suite K
Englewood, CO 80112
Phone: (303) 790-1020
Fax: (303) 790-1037

REGION 1



5500 Greenwood Plaza Blvd.
Suite 150
Greenwood Village, CO 80111
Phone: 303/221-7275
Fax: 303/221-7276

As Constructed

No. Revisions:	
Revised:	
Void:	

US 85 CROSS SECTIONS

Designer:	DAF
Detailer:	DAF
Sheet Subset:	Roadway
Subset Sheets:	
	of

Project No./Code

NH 0852-086
13429
Sheet Number: 337

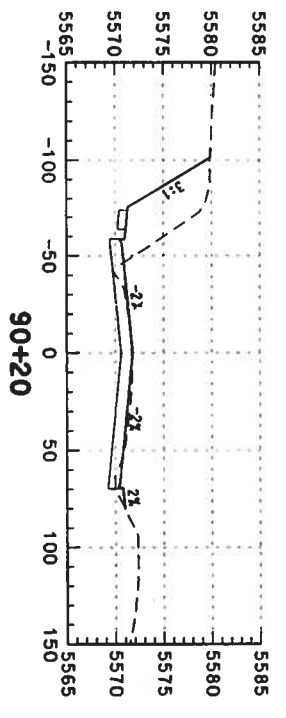
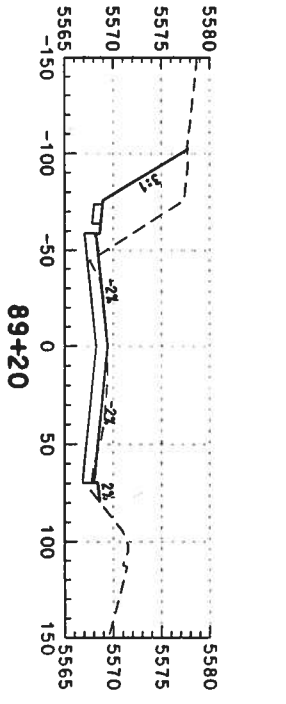
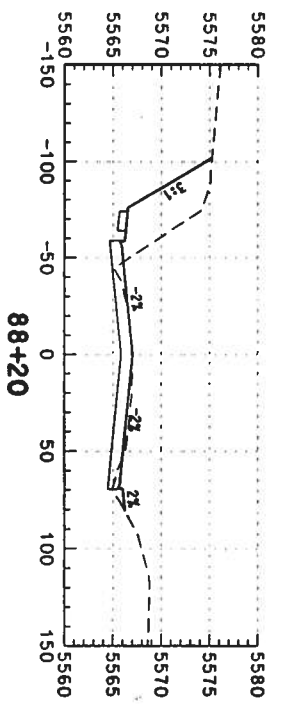
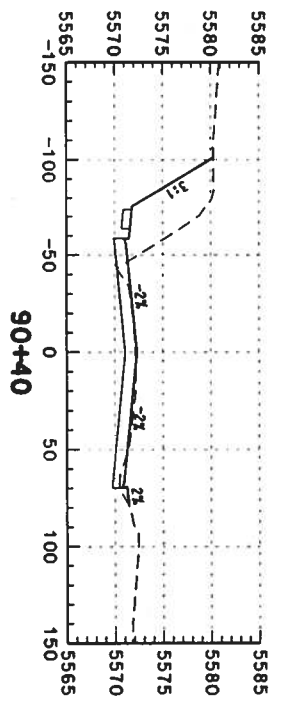
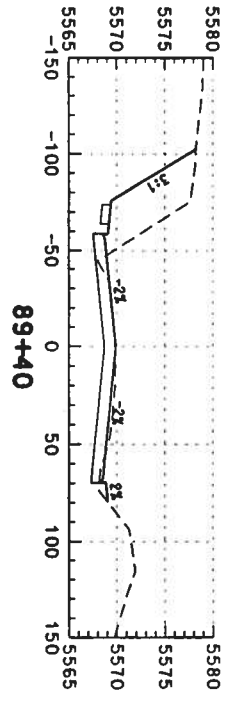
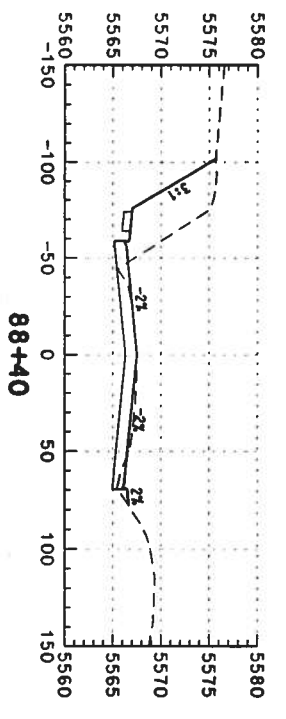
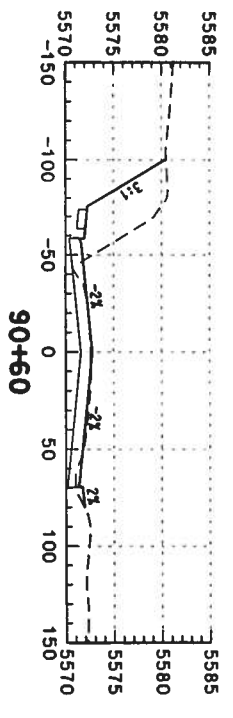
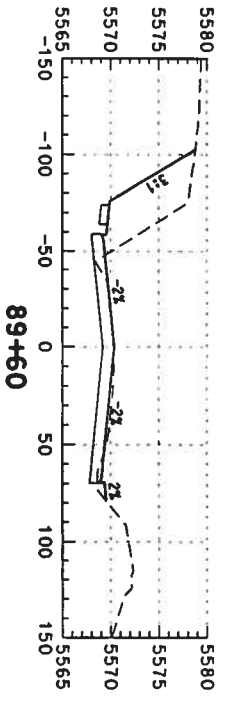
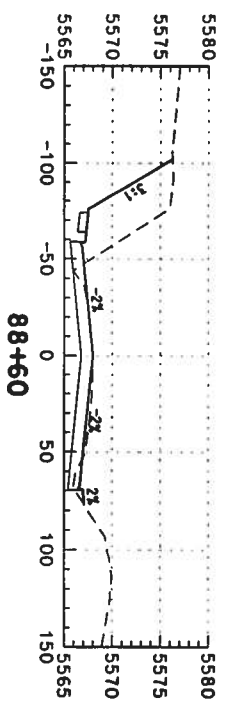
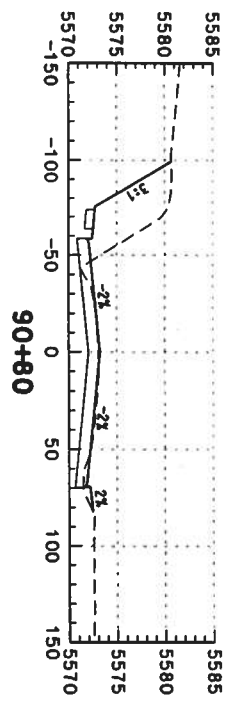
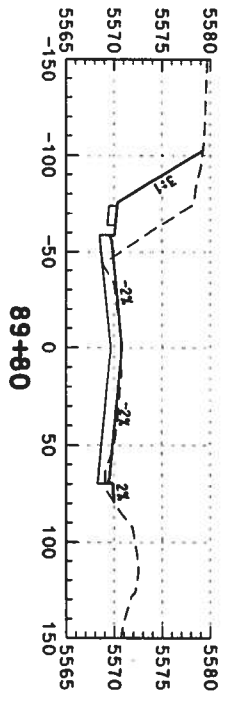
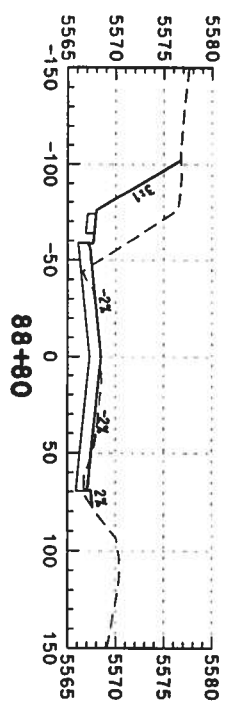
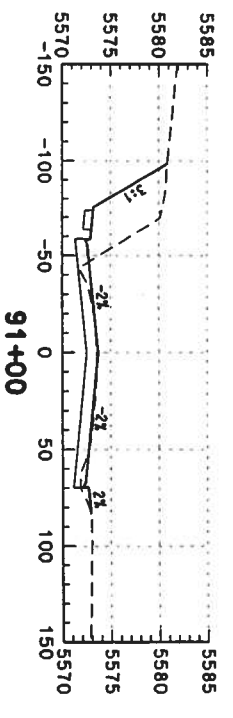
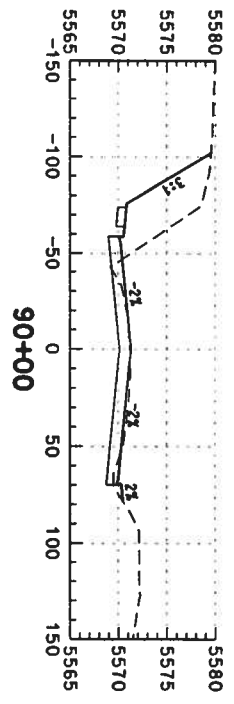
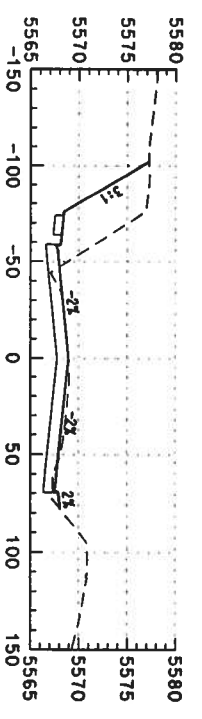

Computer File Information	
Creation Date:	02/14/03
Last Modification Date:	
Initials:	DAF
Full Path:	S:\Transport\246042\2\HwyDes\Plans\rdxs-no-24039.dgn
Drawing File Name:	
Scale:	Units: ENGLISH

Index of Revisions	



339 Inverness Dr. South
Suite K
Englewood, CO 80112
Phone: (303) 790-1020
Fax: (303) 790-1037

REGION 1



5500 Greenwood Plaza Blvd.
Suite 150
Greenwood Village, CO 80111
Phone: 303/221-7275
Fax: 303/221/7276

As Constructed	
No. Revisions:	
Revised:	
Void:	

US 85 CROSS SECTIONS	
Designer:	DAF
Detailer:	DAF
Sheet Subset:	Roadway
Structure Numbers:	
Subset Sheets:	
	of

Project No./Code	
NH 0852-086	
Sheet Number:	338

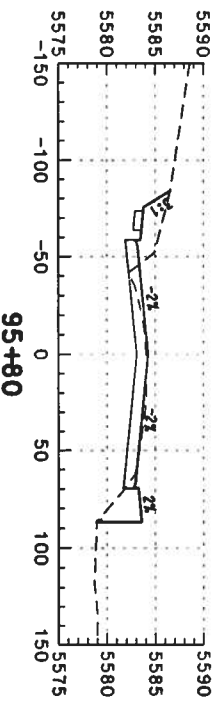
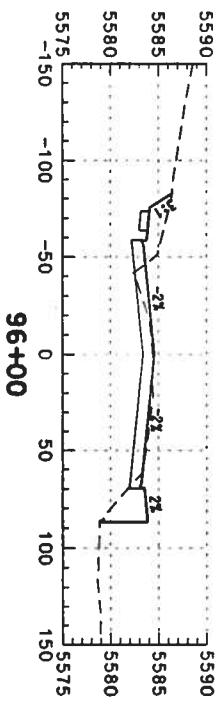
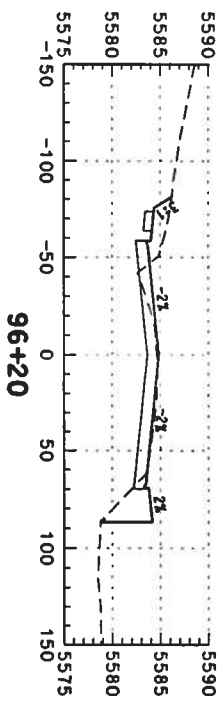
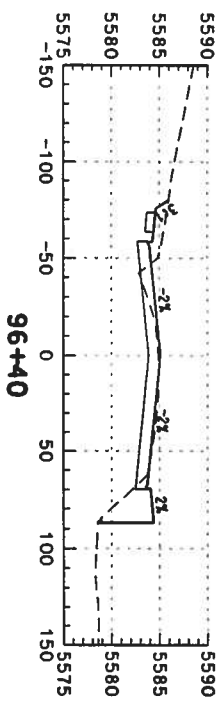
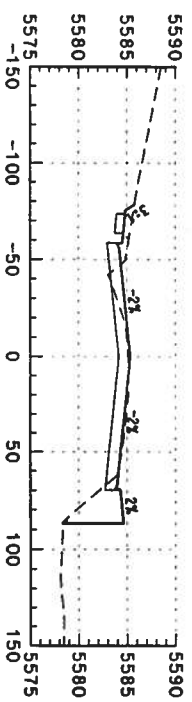
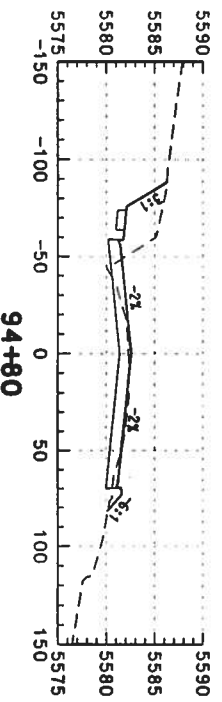
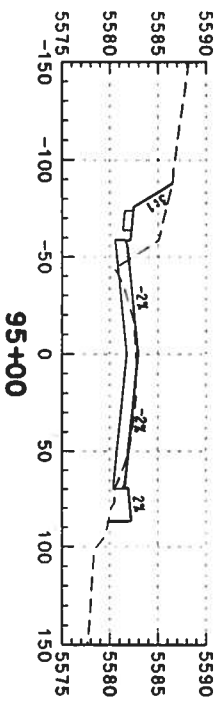
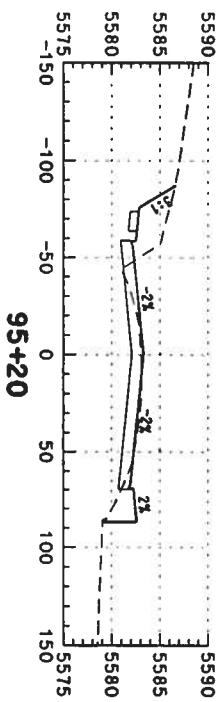
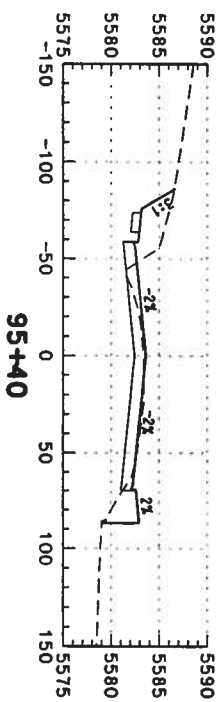
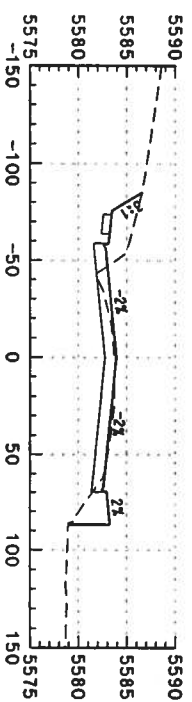
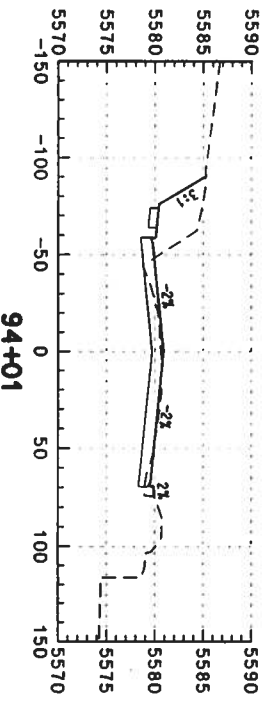
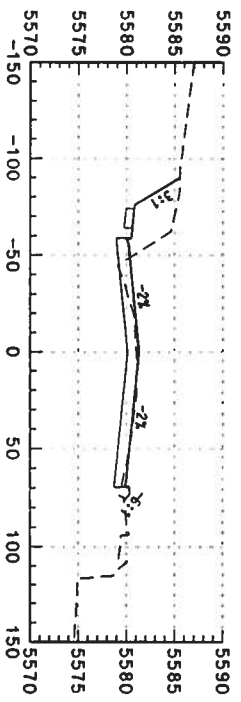
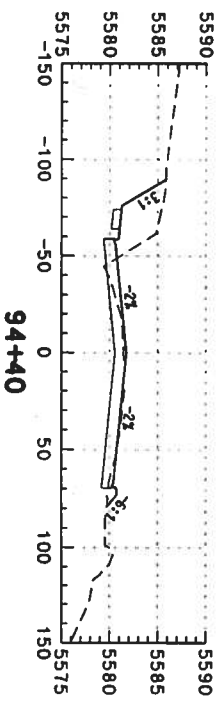
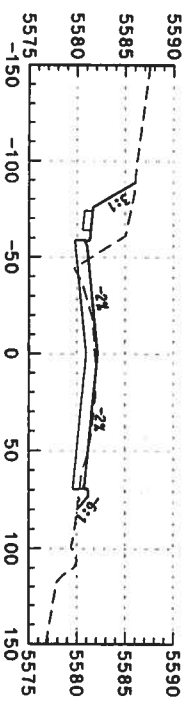

Computer File Information	
Creation Date:	02/14/03
Last Modification Date:	
Initials:	DAF
Full Path:	S:\Tranpro\24604.2\HwyDes\Plans\rdxs-no-2d041.dgn
Drawing File Name:	
Scale:	Units: ENGLISH

Index of Revisions	

DOT
 DEPARTMENT OF TRANSPORTATION
 REGION 1
 359 Inverness Dr. South
 Suite K
 Englewood, CO 80112
 Phone: (303) 790-1020
 Fax: (303) 790-1037

PBSJ
 5500 Greenwood Plaza Blvd.
 Suite 150
 Greenwood Village, CO 80111
 Phone: 303/221-7275
 Fax: 303/221-7276

As Constructed	
No. Revisions:	
Revised:	
Void:	

US 85 CROSS SECTIONS	
Designer:	DAF
Detailer:	DAF
Sheet Subset:	Roadway
Structure Numbers:	
Subset Sheets:	
	of

Project No./Code	
NH 0852-086	
Sheet Number:	340

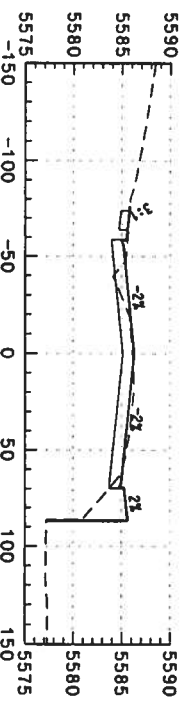

97+60

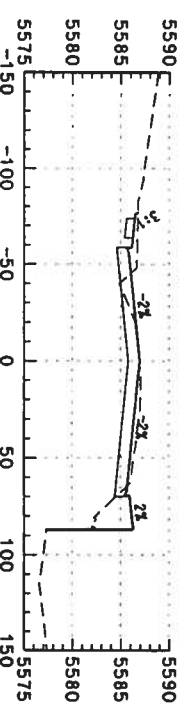

98+60

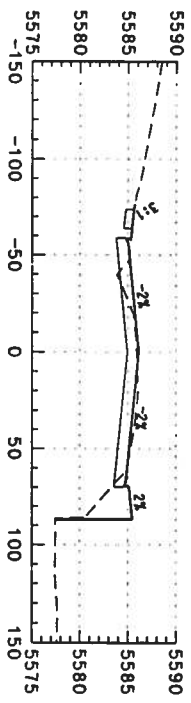

97+40

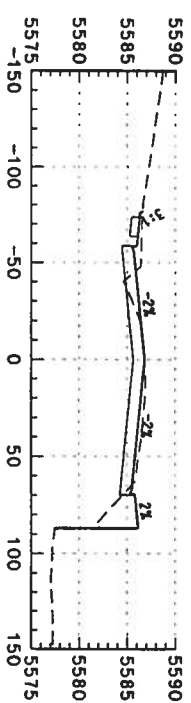

98+40

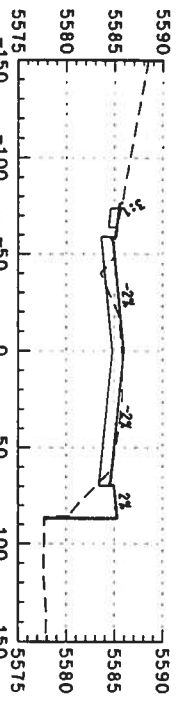

97+20

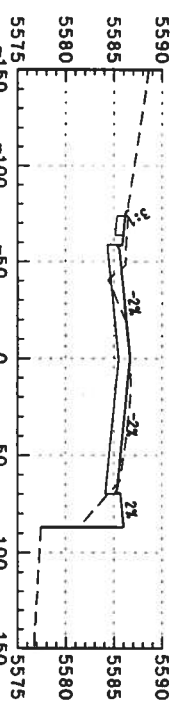

98+20

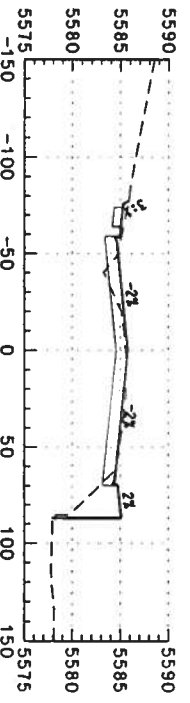

97+00

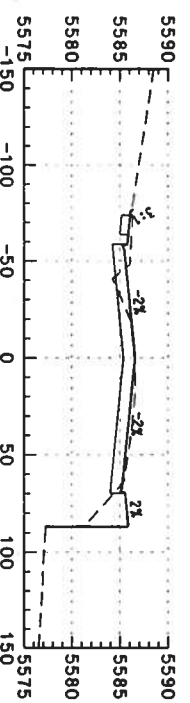

98+00

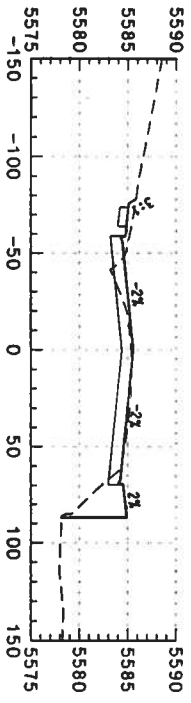

96+80

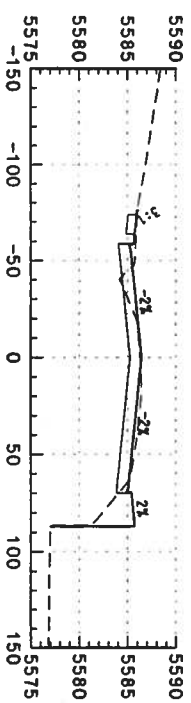

97+80

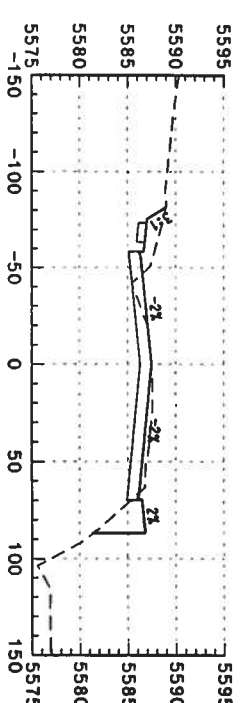

99+40

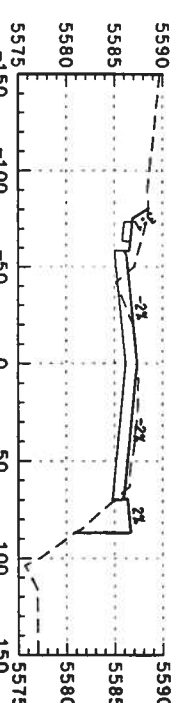

99+20

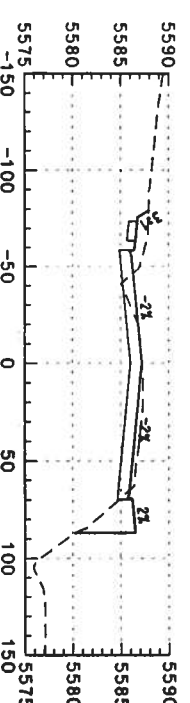

99+00

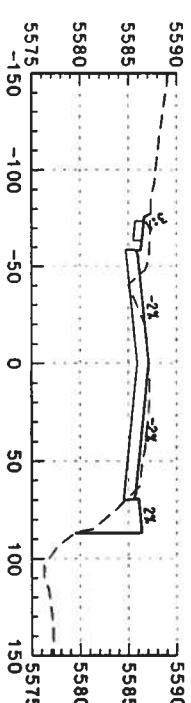

98+80

Computer File Information

Creation Date:	02/14/03	Initials:	DAF
Lost Modification Date:		Initials:	
Full Path:	S:\Trompro\246042.12\HwyDes\Plans\		
Drawing File Name:	rds-no-2d042.dgn		
Scale:	Units: ENGLISH		

Index of Revisions



DOT
DEPARTMENT OF TRANSPORTATION

359 Inverness Dr. South
Suite K
Englewood, CO 80112
Phone: (303) 790-0020
Fax: (303) 790-0057



PBSJ

5500 Greenwood Plaza Blvd.
Suite 150
Greenwood Village, CO 80111
Phone: 303/221-7275
Fax: 303/221/7276

As Constructed

No. Revisions:	
Revised:	
Void:	

US 85 CROSS SECTIONS

Designer:	DAF	Structure	
Detailer:	DAF	Numbers	
Sheet Subset:	Roadway	Subset Sheets:	
		of	

Project No./Code

NH 0852-086
13429
Sheet Number: 341

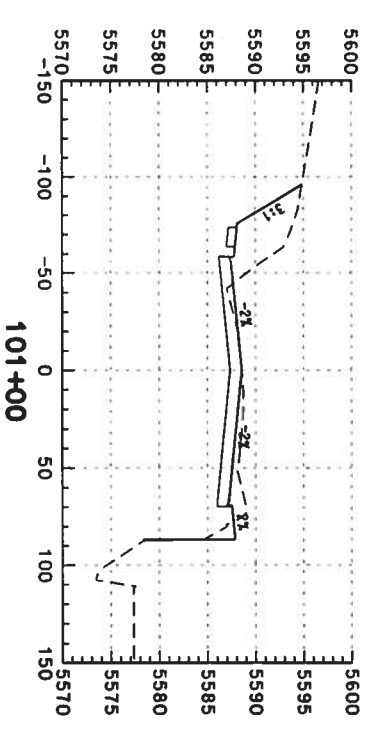
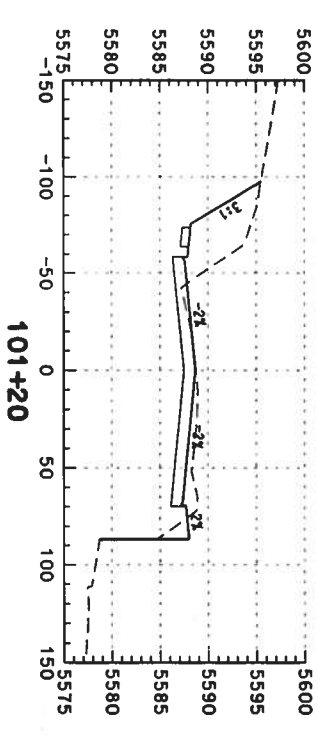
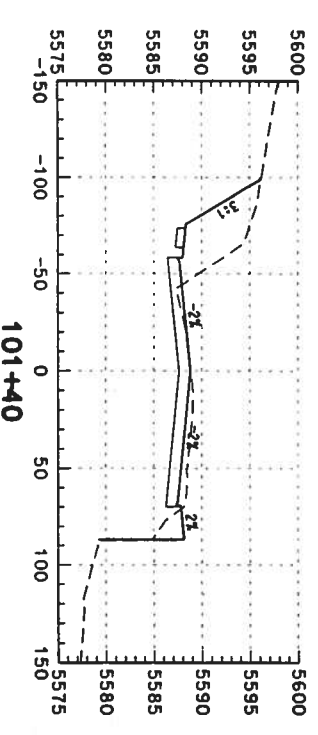
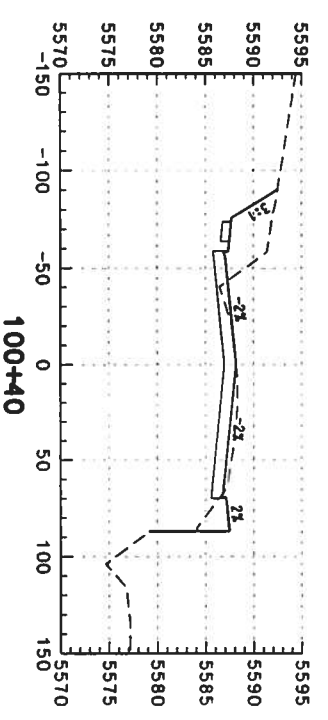
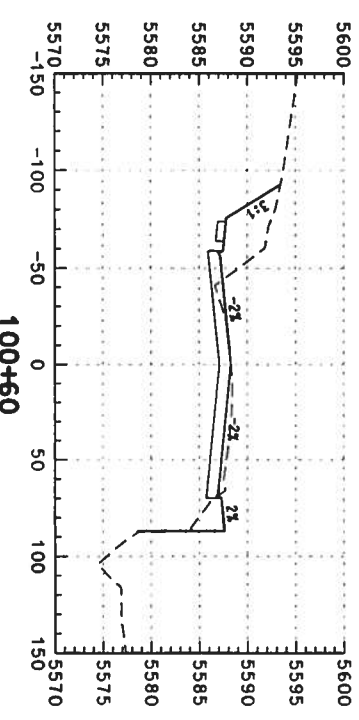
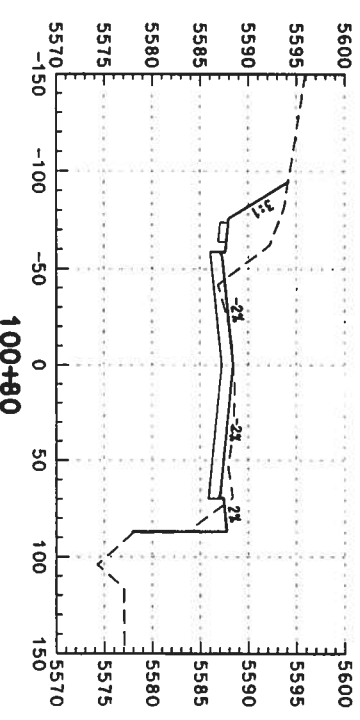
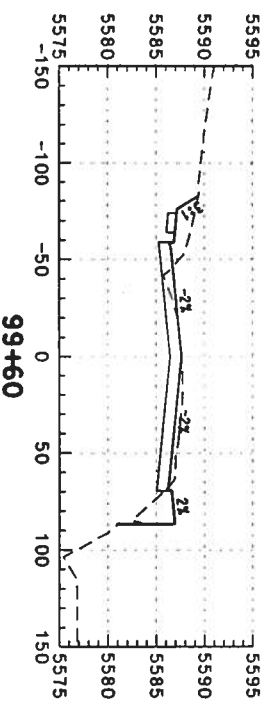
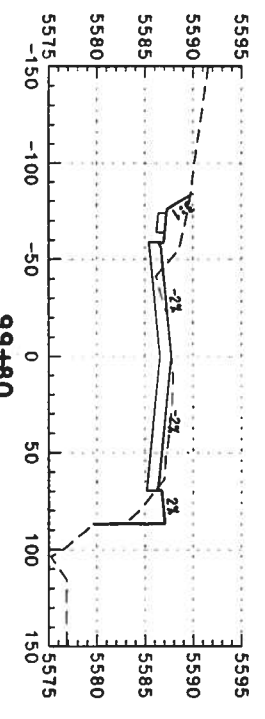
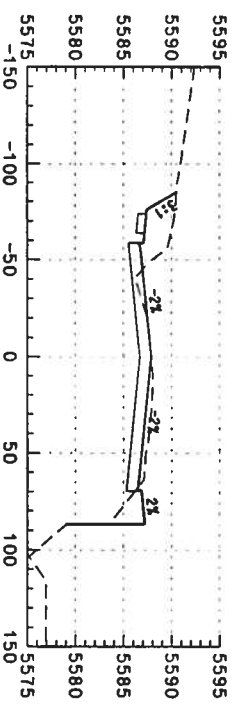
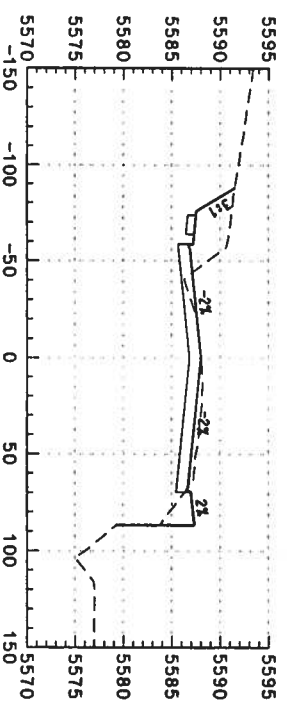

Computer File Information

Creation Date: 02/14/03 Initials: DAF
 Last Modification Date: Initials:
 Full Path: S:\Tranpro\246042\24HWyDes\Plans\
 Drawing File Name: rdxs-no-20043.dgn
 Scale: Units: ENGLISH

Index of Revisions



359 Inverness Dr. South
 Suite K
 Englewood, CO 80112
 Phone: (303) 790-1020
 Fax: (303) 790-1037

REGION 1



5500 Greenwood Plaza Blvd.
 Suite 150
 Greenwood Village CO 80111
 Phone: 303/221-7275
 Fax: 303/221/7276

As Constructed

No. Revisions:
 Revised:
 Void:

US 85 CROSS SECTIONS

Designer: DAF
 Detailer: DAF
 Sheet Subset: Roadway

Project No./Code

NH 0852-086
 13429
 Sheet Number: 342

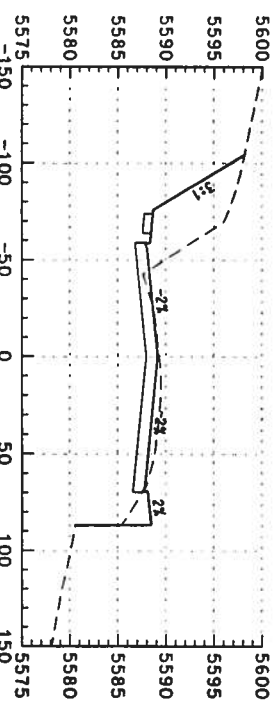

102+00

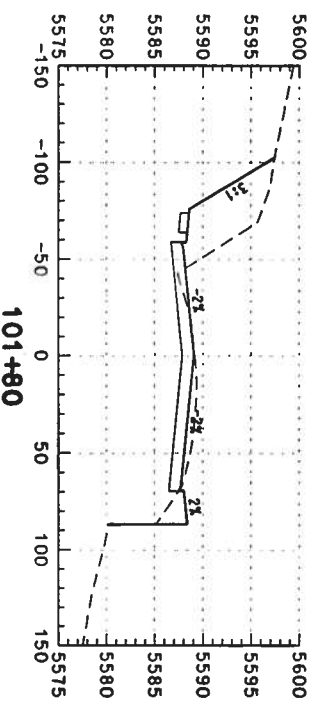

101+80

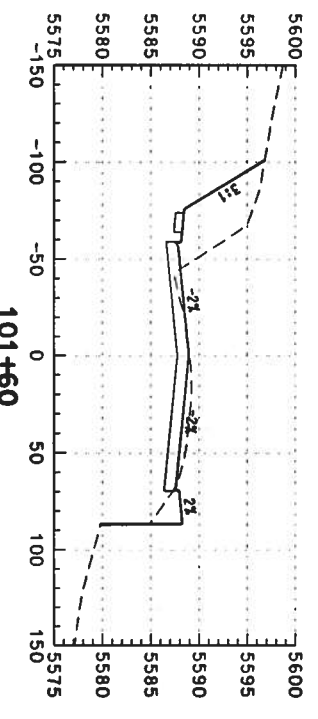

101+60

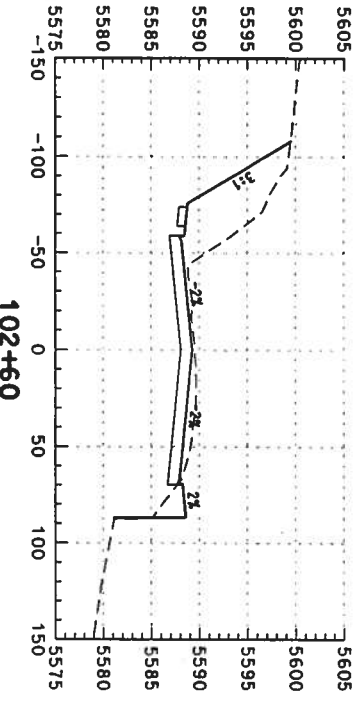

102+60

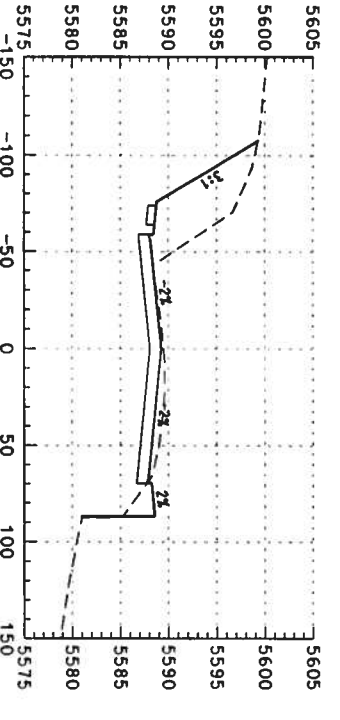

102+40

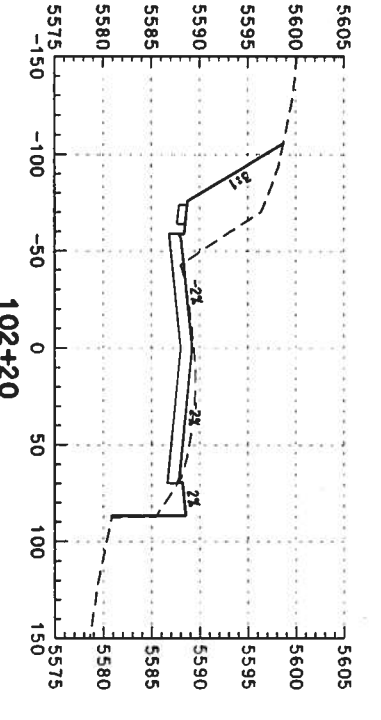

102+20

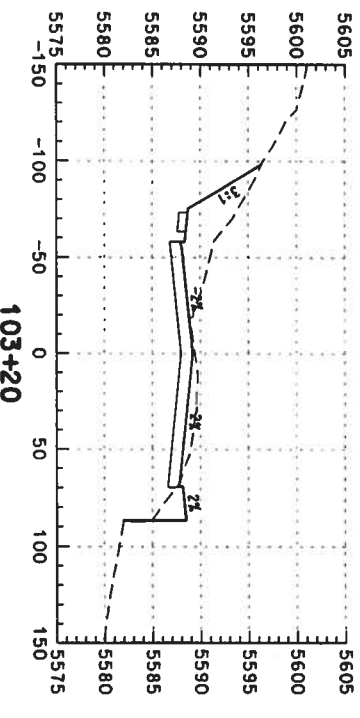

103+20

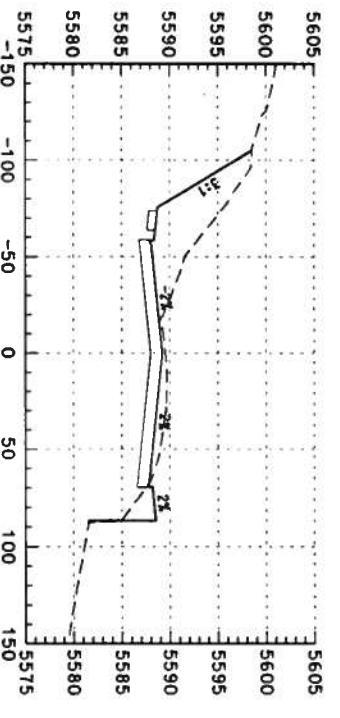

103+00

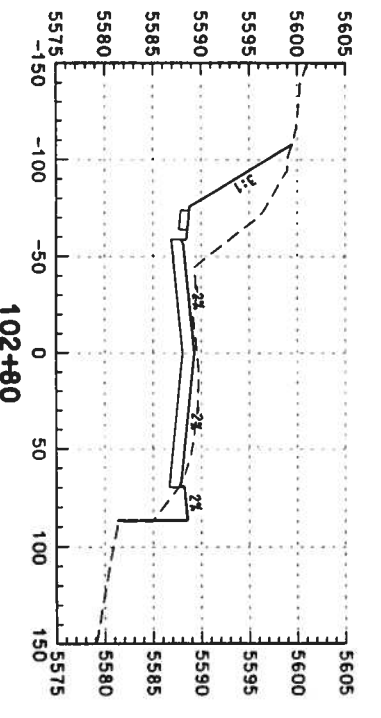

102+80

Computer File Information

Creation Date: 02/14/03 Initials: DAF
 Last Modification Date: Initials:
 Full Path: S:\Transport\246042.12\HwyDes\Plans\
 Drawing File Name: rdxs-no-2004.dgn
 Scale: Units: ENGLISH

Index of Revisions



359 Inverness Dr. South
 Suite K
 Englewood, CO 80112
 Phone: (303) 790-1020
 Fax: (303) 790-1037

REGION I



5500 Greenwood Plaza Blvd.
 Suite 150
 Greenwood Village, CO 80111
 Phone: 303/221-7275
 Fax: 303/221/7276

As Constructed

No. Revisions:
 Revised:
 Void:

US 85 CROSS SECTIONS

Designer: DAF
 Detailer: DAF
 Sheet Subset: Roadway
 Structure Numbers
 Subset Sheets: of

Project No./Code

NH 0852-086
 13429
 Sheet Number: 343

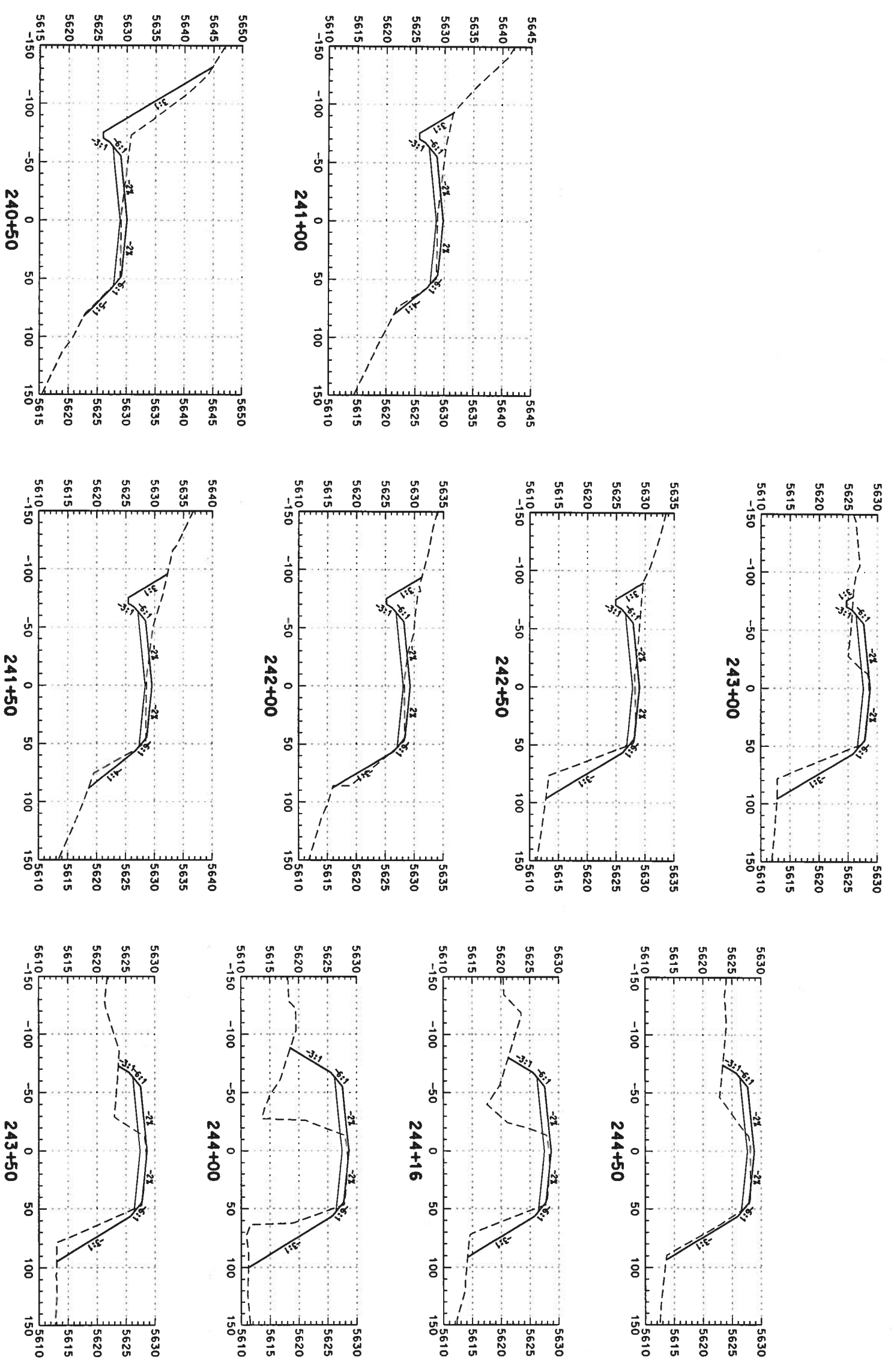

Computer File Information

Creation Date: 02/14/03
 Last Modification Date: 02/14/03
 Full Path: S:\Tranpro\246042.12\HwyDes\Plans\
 Drawing File Name: rdxs-so-2d046.dgn
 Scale: Units: ENGLISH

Index of Revisions

Initials: DAF	



DOT
DEPARTMENT OF TRANSPORTATION

359 Inverness Dr. South
 Suite K
 Englewood, CO 80112
 Phone: (303) 790-1020
 Fax: (303) 790-1037



PBSJ

5500 Greenwood Plaza Blvd.
 Suite 150
 Greenwood Village, CO 80111
 Phone: 303/221-7275
 Fax: 303/221/7276

As Constructed

No. Revisions:
 Revised:
 Void:

US 85 CROSS SECTIONS

Designer: DAF
 Detailer: DAF
 Sheet Subset: Roadway
 Subset Sheets: of

Project No./Code

NH 0852-086
 13429
 Sheet Number: 345

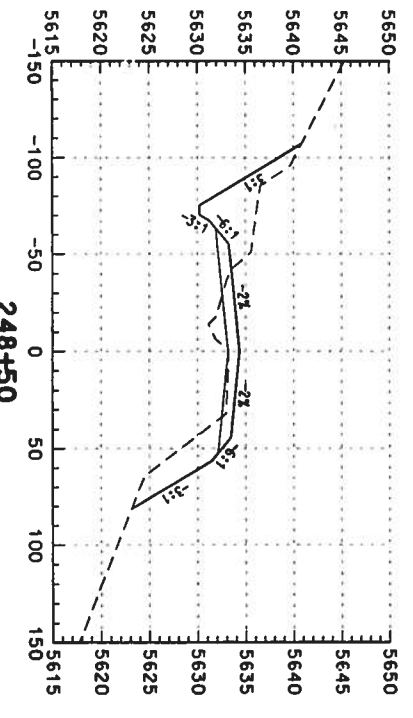
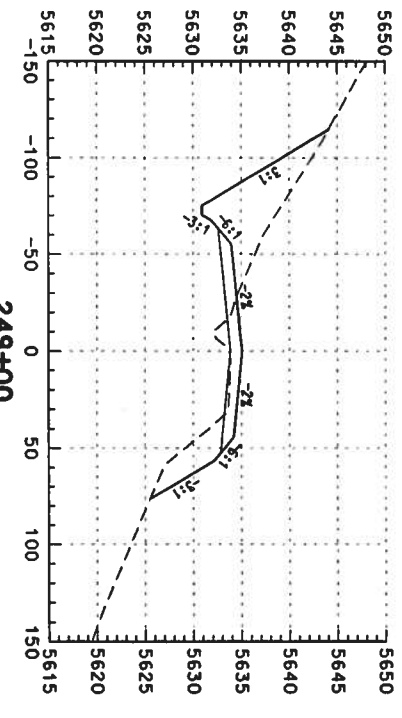
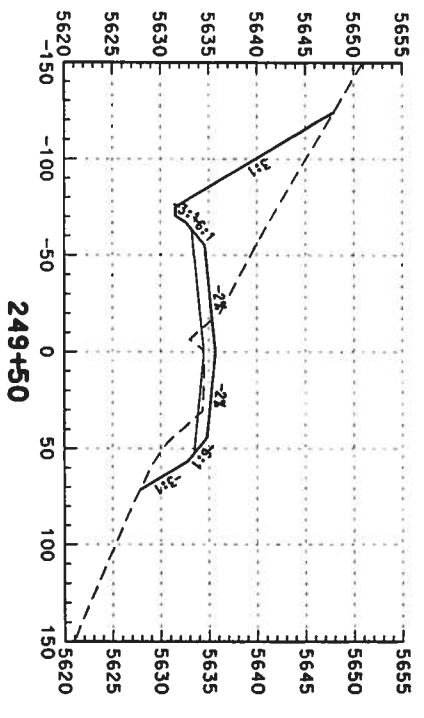
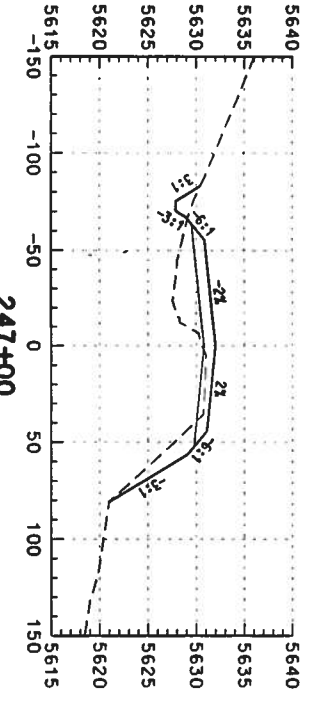
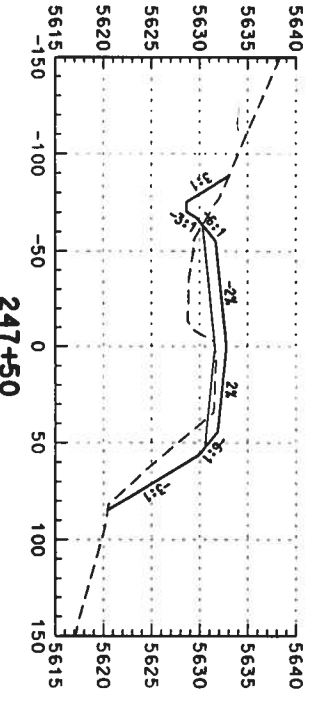
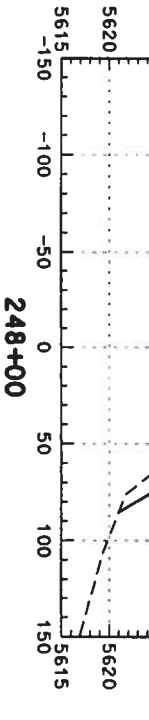
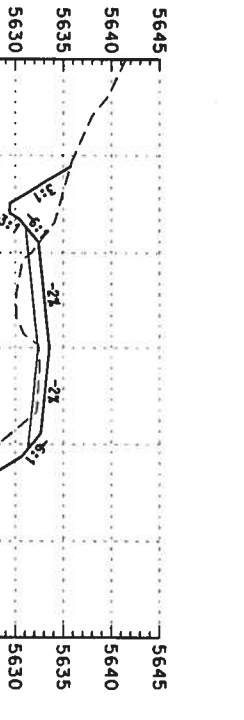
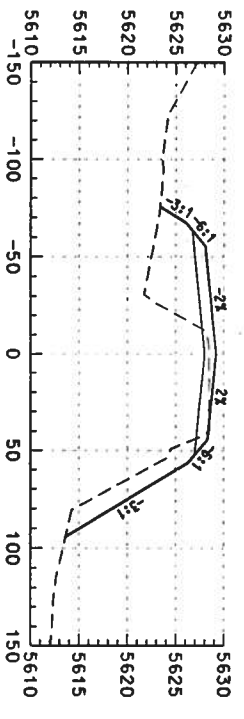
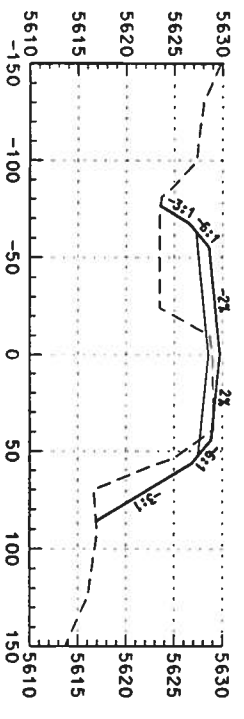
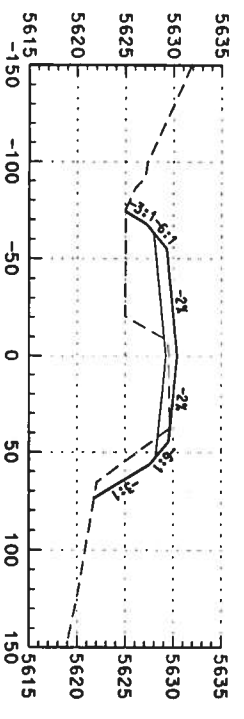
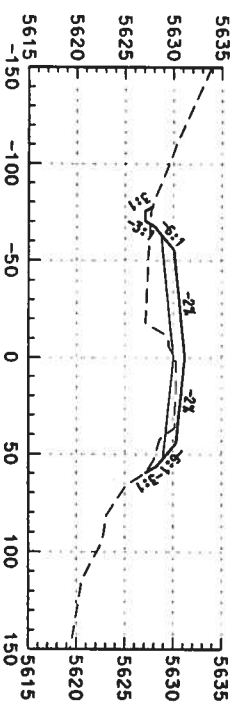

Computer File Information

Creation Date:	02/14/03	Initials:	DAF
Last Modification Date:		Initials:	
Full Path:	S:\Temp\proj\246042\246042.dwg		
Drawing File Name:	rdxs-so-24047.dgn		
Scale:	Units: ENGLISH		

Index of Revisions



359 Inverness Dr. South
Suite K
Englewood, CO 80122
Phone: (303) 790-1020
Fax: (303) 790-1037

REGION 1



5500 Greenwood Plaza Blvd.
Suite 150
Greenwood Village, CO 80111
Phone: 303/221-7275
Fax: 303/221-7276

As Constructed

No. Revisions:	
Revised:	
Void:	

US 85 CROSS SECTIONS

Designer:	DAF	Structure	
Detailer:	DAF	Numbers	
Sheet Subset:	Roadway	Subset Sheets:	
		of	

Project No./Code

NH 0852-086
13429
Sheet Number: 346

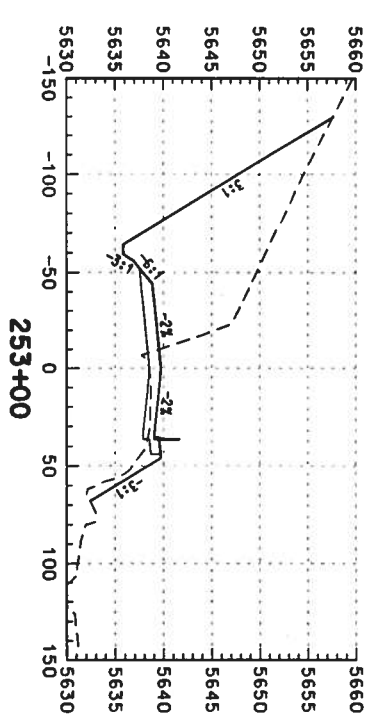
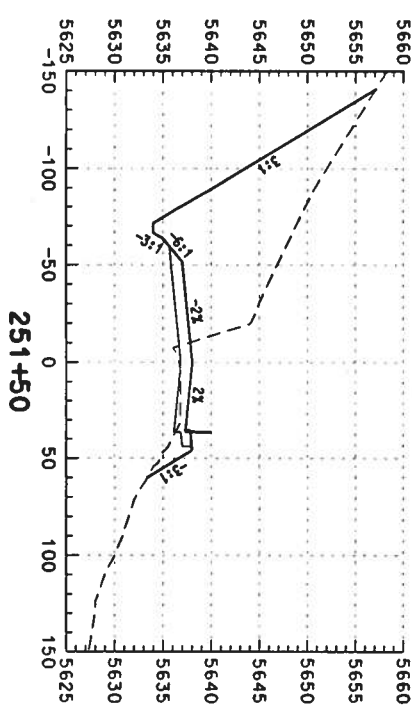
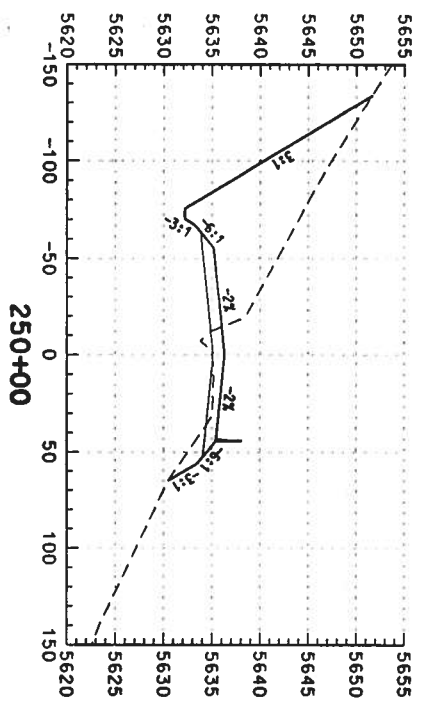
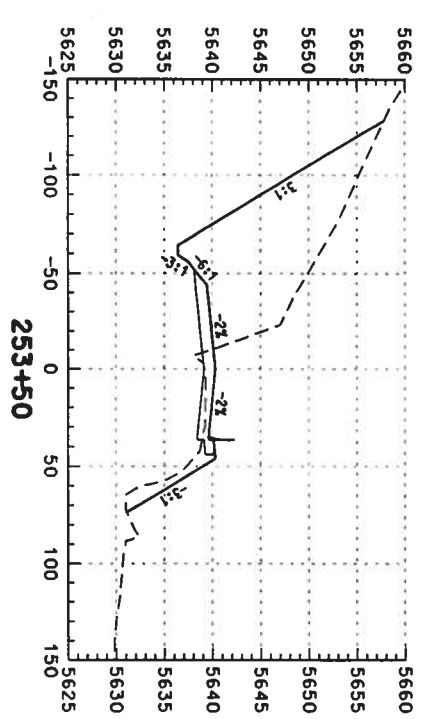
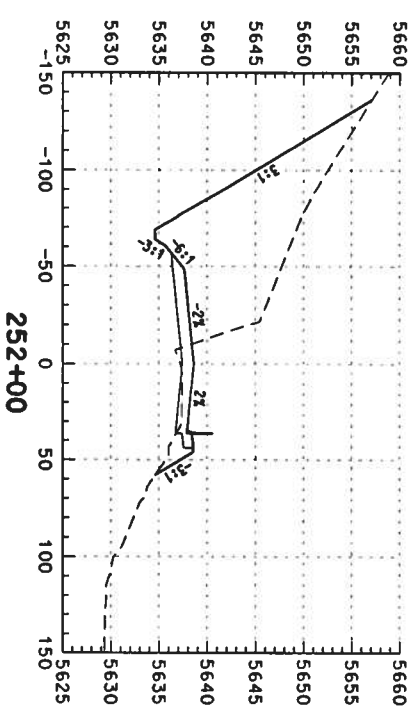
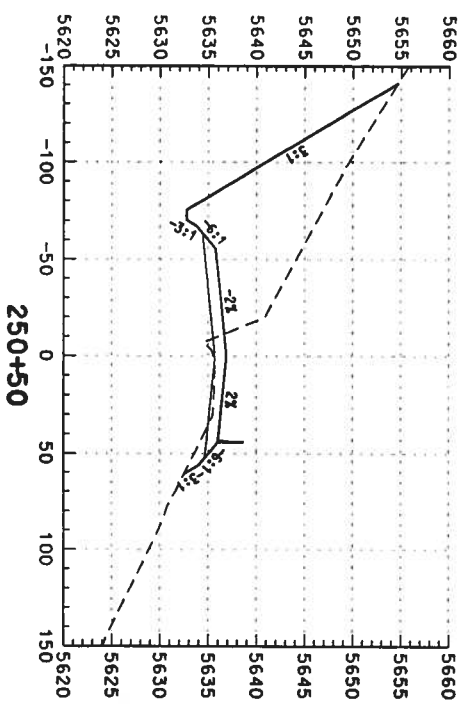
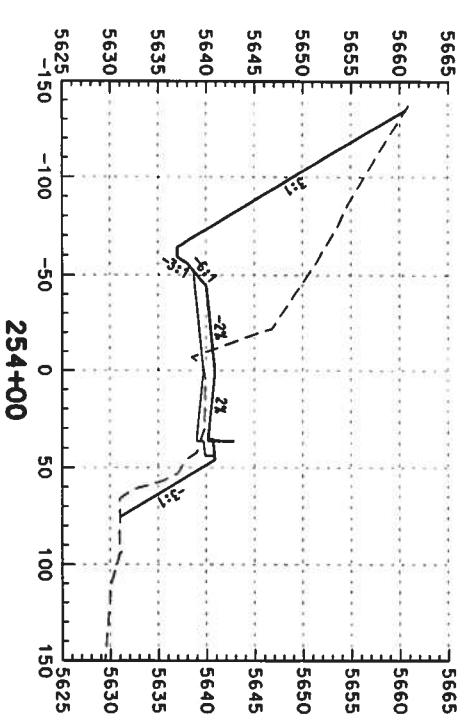
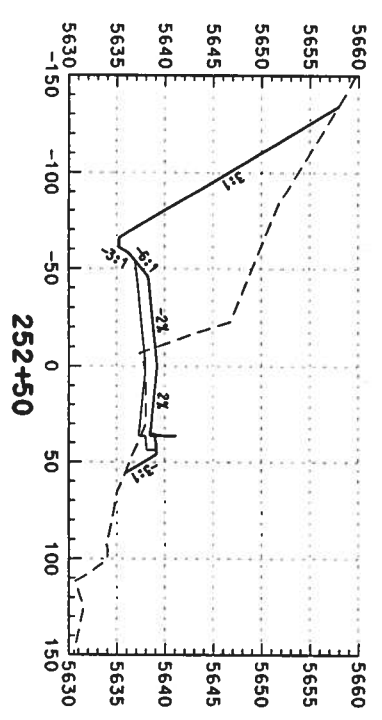
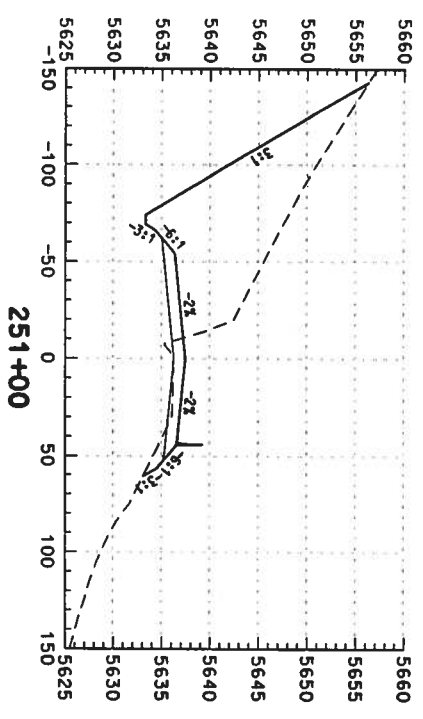

Computer File Information

Creation Date: 02/14/03 Initials: DAF
 Last Modification Date: Initials:
 Full Path: S:\Transport\246042\HWDes\Plans\
 Drawing File Name: rdxs-so-20048.dgn
 Scale: Units: ENGLISH

Index of Revisions



359 Inverness Dr. South
 Suite K
 Englewood, CO 80112
 Phone: (303) 790-1020
 FAX: (303) 790-1037



5500 Greenwood Plaza Blvd.
 Suite 150
 Greenwood Village, CO 80111
 Phone: 303/221-7275
 Fax: 303/221/7276

As Constructed
 No. Revisions:
 Revised:
 Void:

US 85 CROSS SECTIONS

Designer: DAF
 Checker: DAF
 Sheet Subset: Roadway
 Subset Sheets: of

Project No./Code
 NH 0852-086

Sheet Number: 347

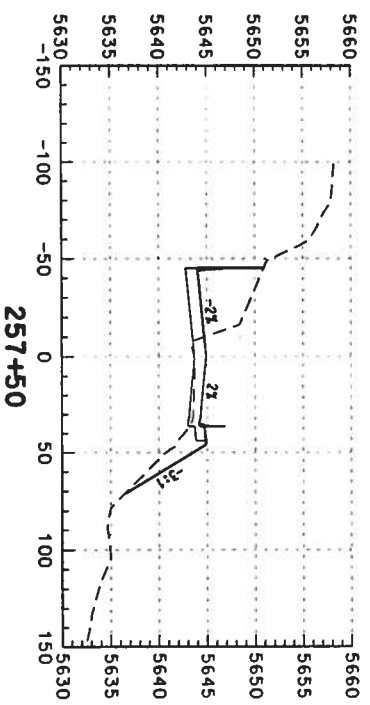
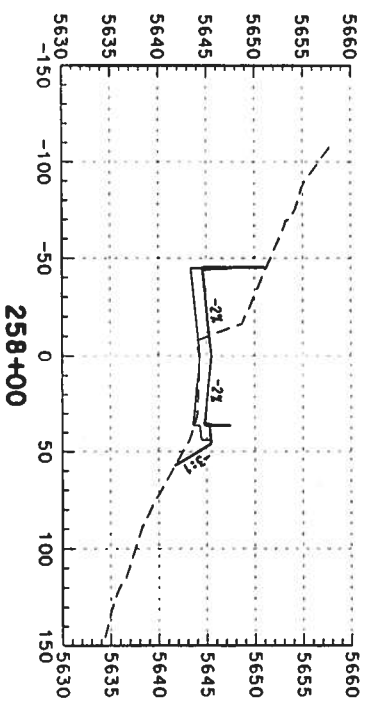
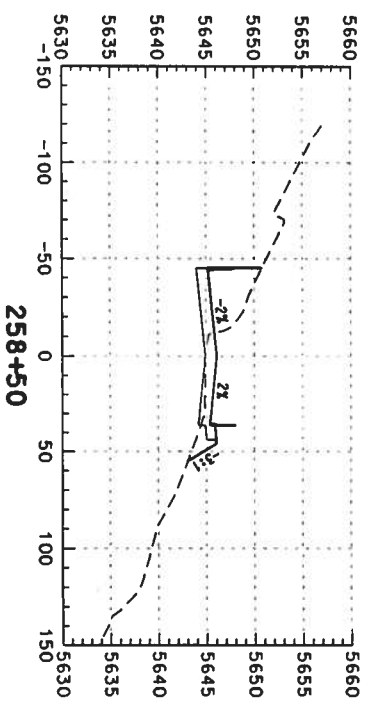
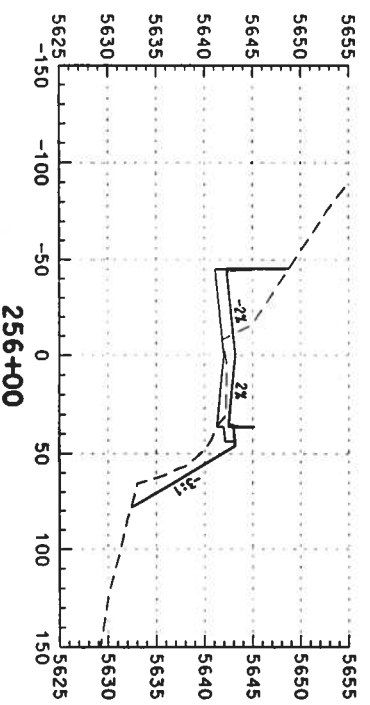
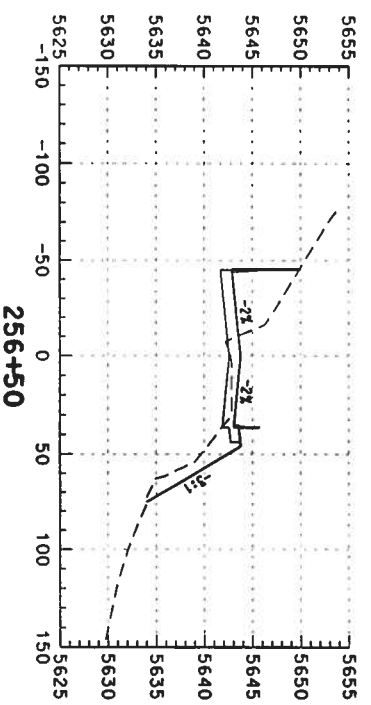
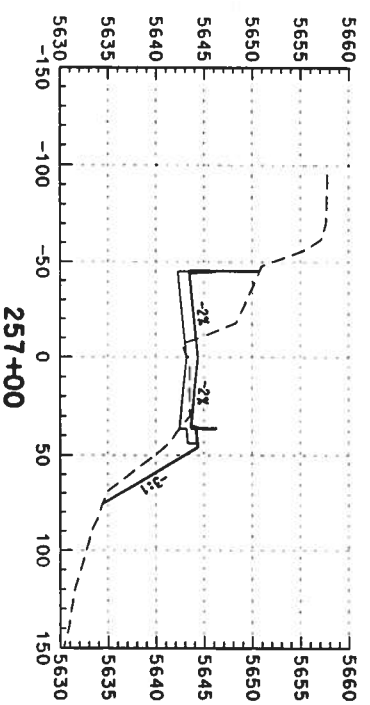
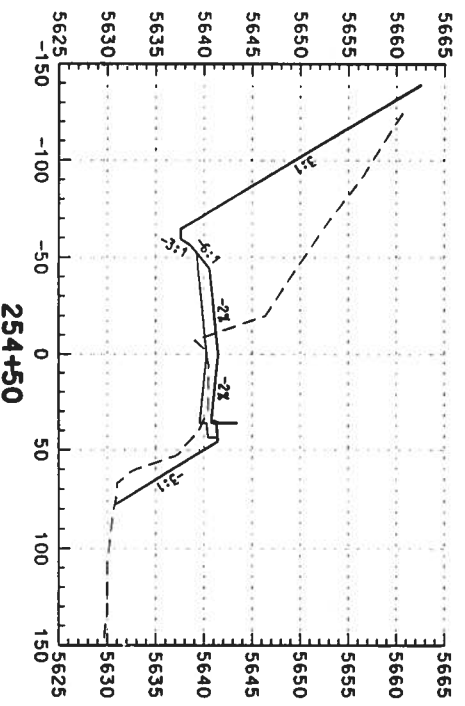
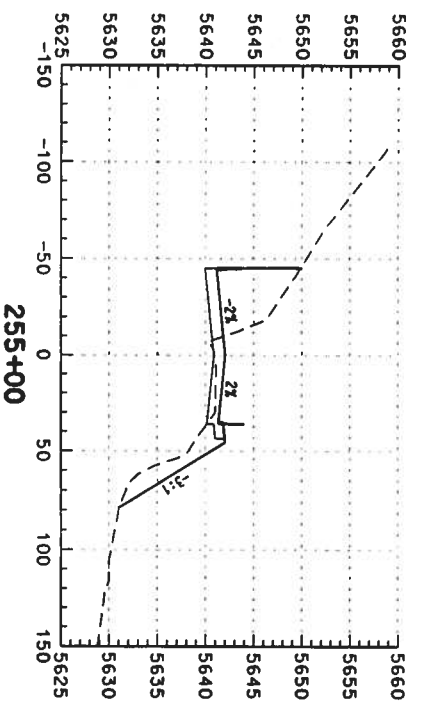
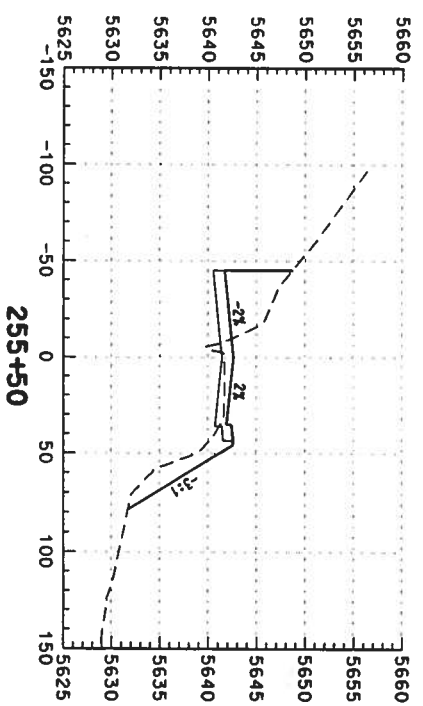

Computer File Information

Creation Date: 02/14/03 Initials: DAF
 Last Modification Date: Initials:
 Full Path: S:\Transport\246042.12\HwyDes\Plans\
 Drawing File Name: rdxs-so-24049.dgn
 Scale: Units: ENGLISH

Index of Revisions



359 Inverness Dr. South
 Suite K
 Englewood, CO 80112
 Phone: (303) 790-1020
 Fax: (303) 790-1037



5500 Greenwood Plaza Blvd.
 Suite 150
 Greenwood Village, CO 80111
 Phone: 303/221-7275
 Fax: 303/221/7276

As Constructed

No. Revisions:	
Revised:	
Void:	

US 85 CROSS SECTIONS

Designer:	DAF	Structure	
Detailer:	DAF	Numbers	
Sheet Subset:	Roadway	Subset Sheets:	of

Project No./Code
 NH 0852-086
 Sheet Number: 13429
 340

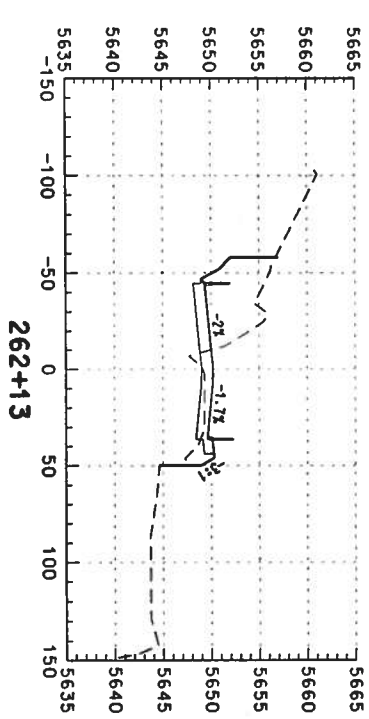
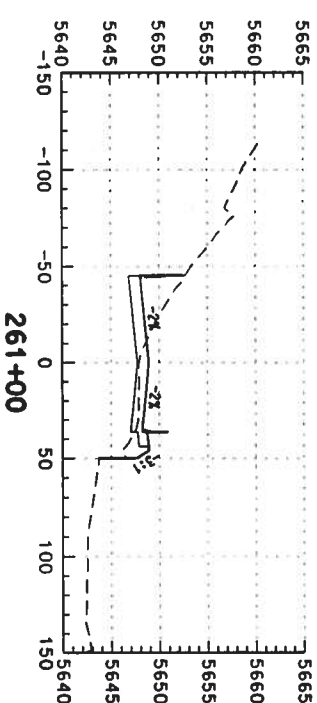
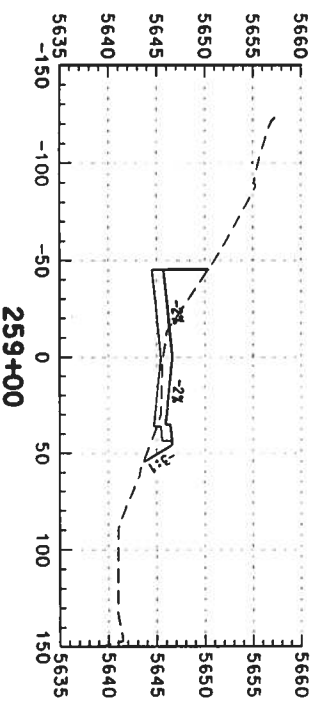
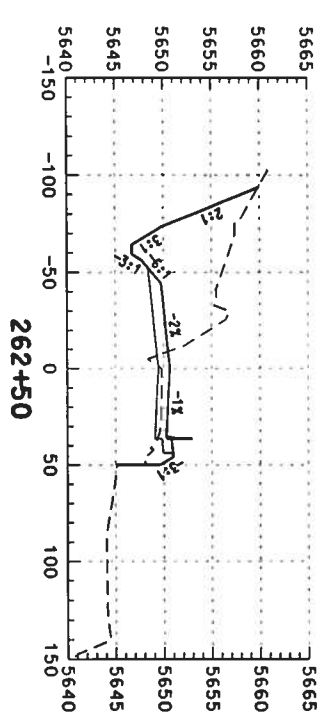
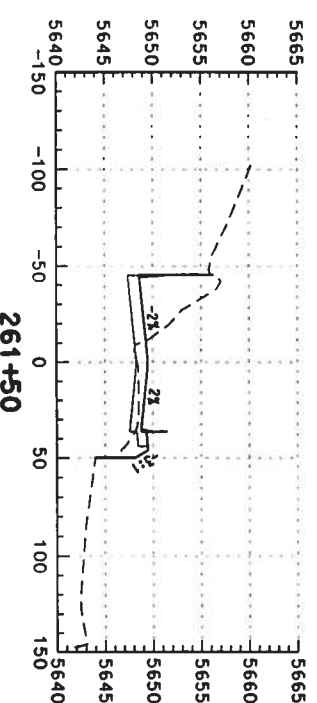
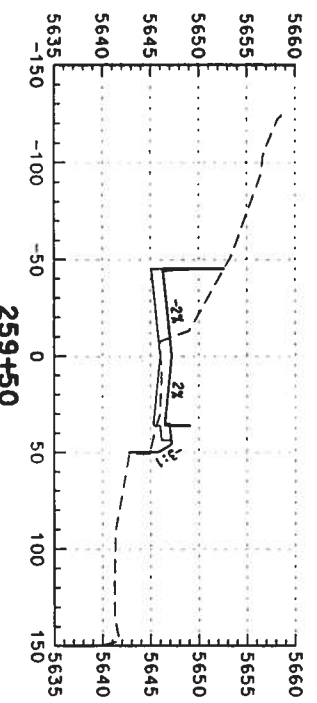
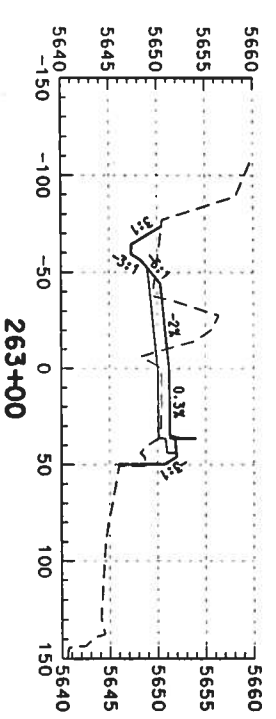
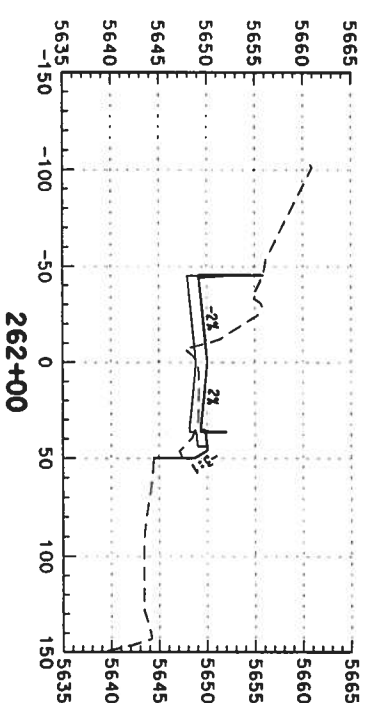
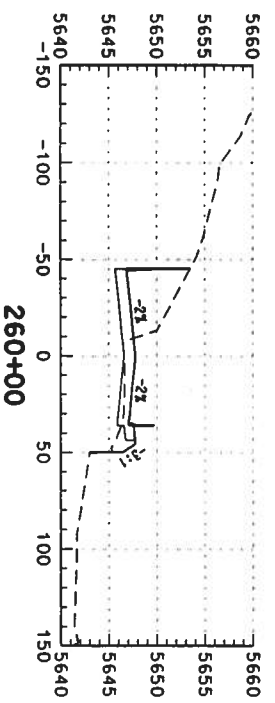
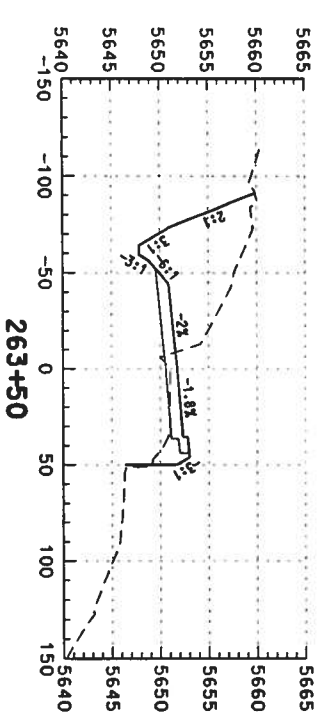
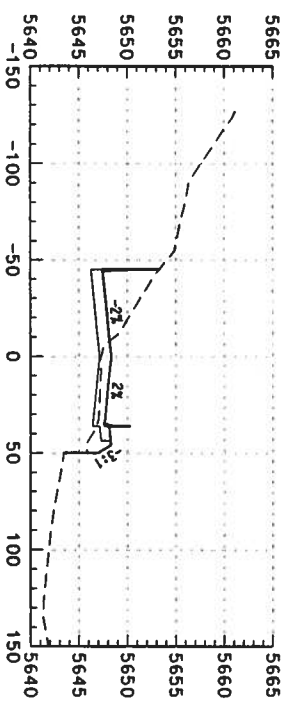

Computer File Information

Creation Date:	02/14/03	Initials:	DAF
Lost Modification Date:		Initials:	
Full Path:	S:\Tranpro\246042\24HWyDes\Plans\		
Drawing File Name:	rdxs-so-26050.dgn		
Scale:	Units: ENGLISH		

Index of Revisions



REGION 1

359 Inverness Dr. South
Suite K
Englewood, CO 80122
Phone: (303) 790-1020
Fax: (303) 790-1037



5500 Greenwood Plaza Blvd.
Suite 150
Greenwood Village, CO 80111
Phone: 303/221-7275
Fax: 303/221-7276

As Constructed

No. Revisions:	
Revised:	
Void:	

US 85 CROSS SECTIONS

Designer:	DAF	Structure	
Detailer:	DAF	Numbers	
Sheet Subset:	Roadway	Subset Sheets:	of

Project No./Code

NH 0852-086

13429

Sheet Number: 349

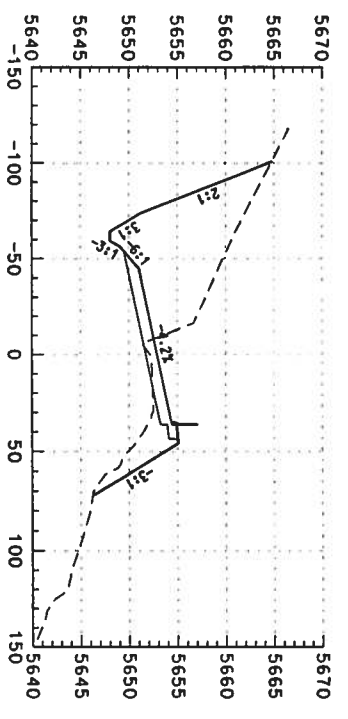

264+50

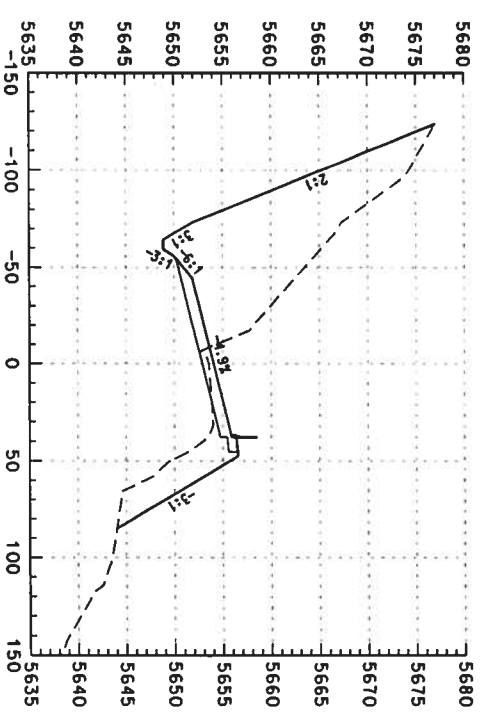

265+50

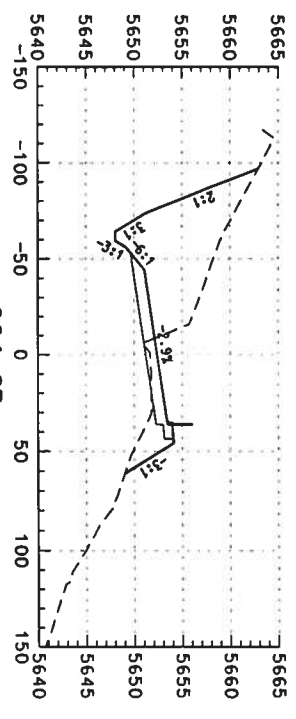

264+03

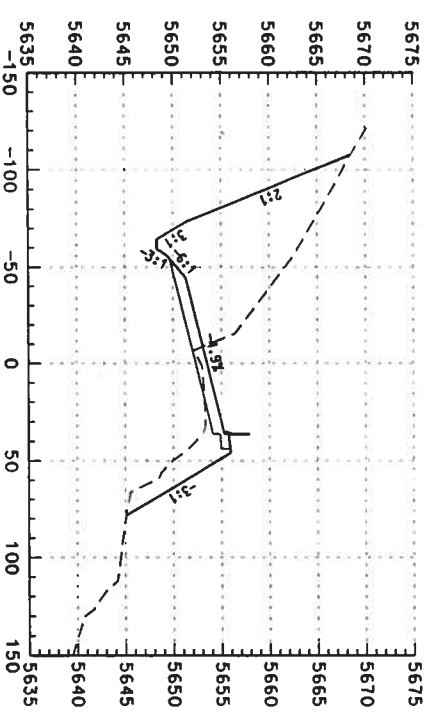

265+00

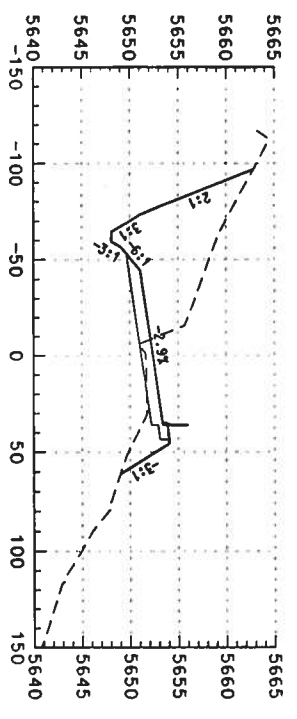

264+00

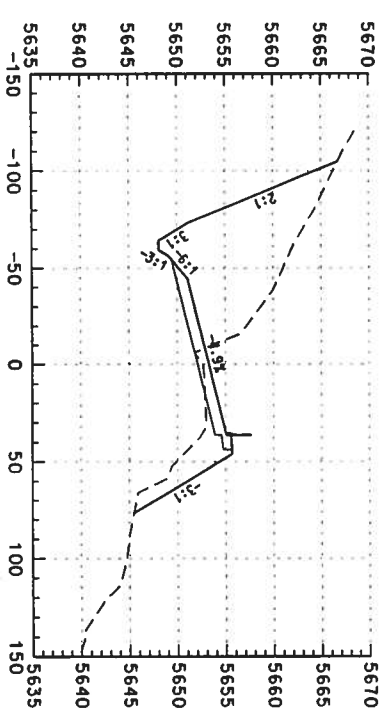

264+78

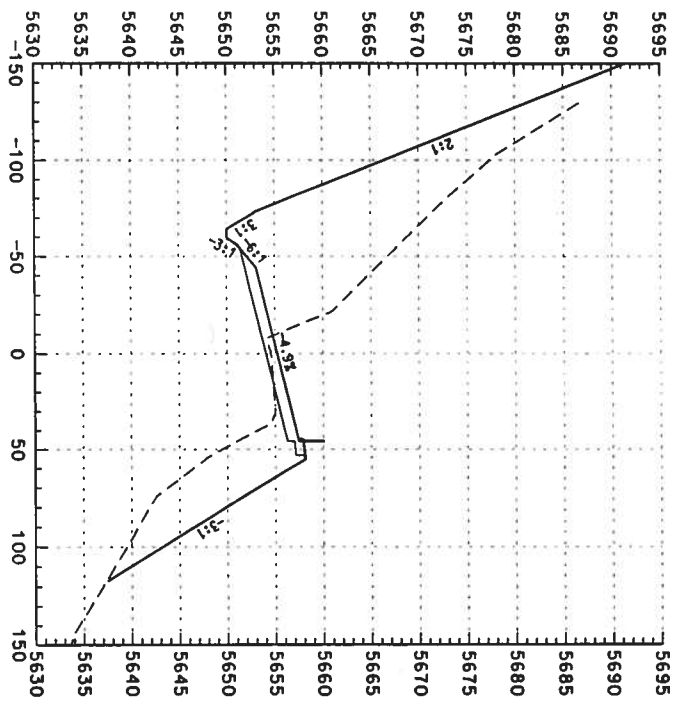

266+50

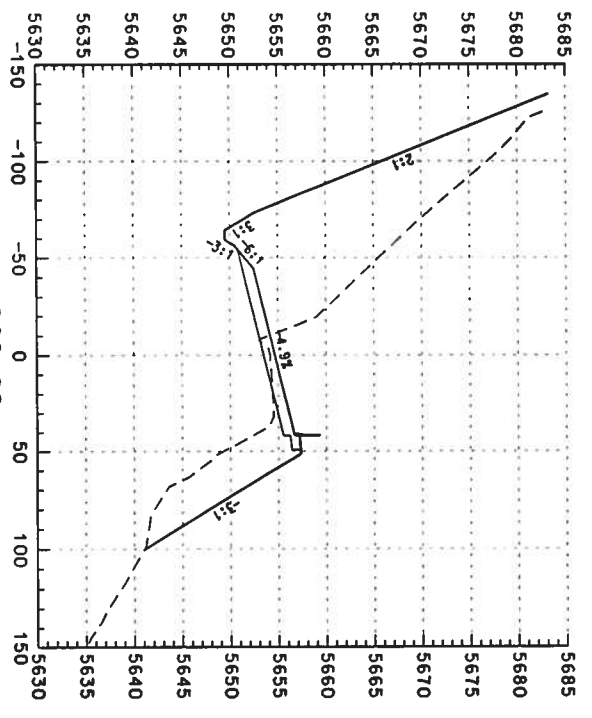

266+00

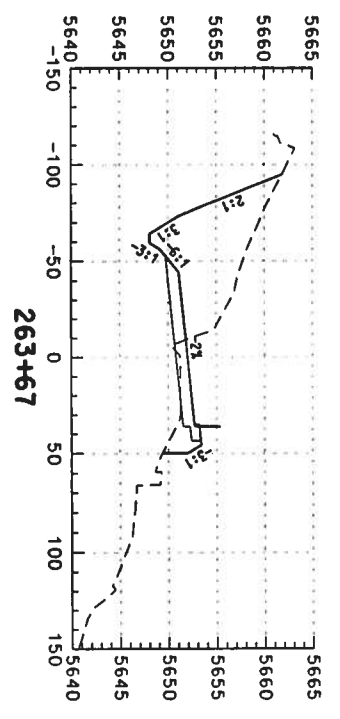

263+67

Computer File Information

Creation Date:	02/14/03	Initials:	DAF
Lost Modification Date:		Initials:	
Full Path:	S:\trnproj\246042\2\HydDes\Plans\		
Drawing File Name:	rdxs-so-2d051.dgn		
Scale:	Units: ENGLISH		

Index of Revisions



359 Inverness Dr. South
Suite K
Englewood, CO 80112
Phone: (303) 790-1020
Fax: (303) 790-1037

REGION 1



5500 Greenwood Plaza Blvd.
Suite 150
Greenwood Village, CO 80111
Phone: 303/221-7275
Fax: 303/221/7276

As Constructed

No. Revisions:	
Revised:	
Void:	

US 85 CROSS SECTIONS

Designer:	DAF	Structure	
Detailer:	DAF	Numbers	
Sheet Subset:	Roadway	Subset Sheets:	of

Project No./Code

NH 0852-086
13429
Sheet Number: 350

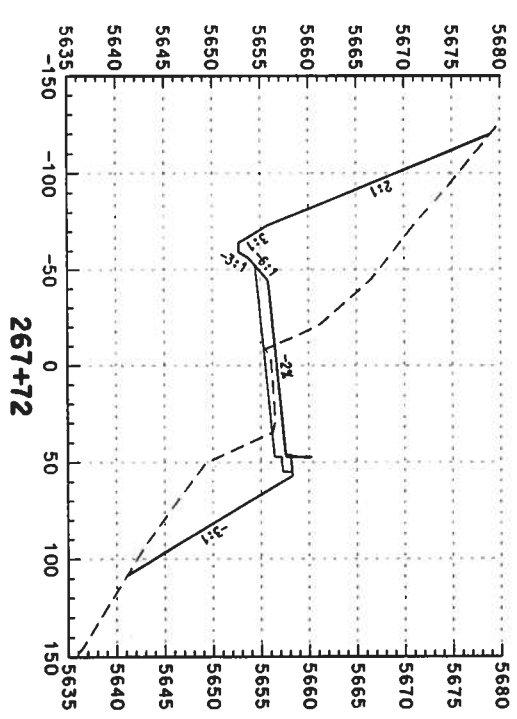
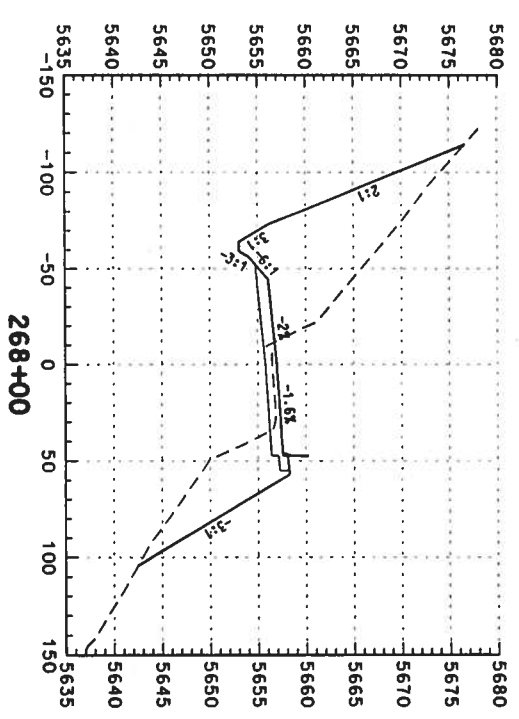
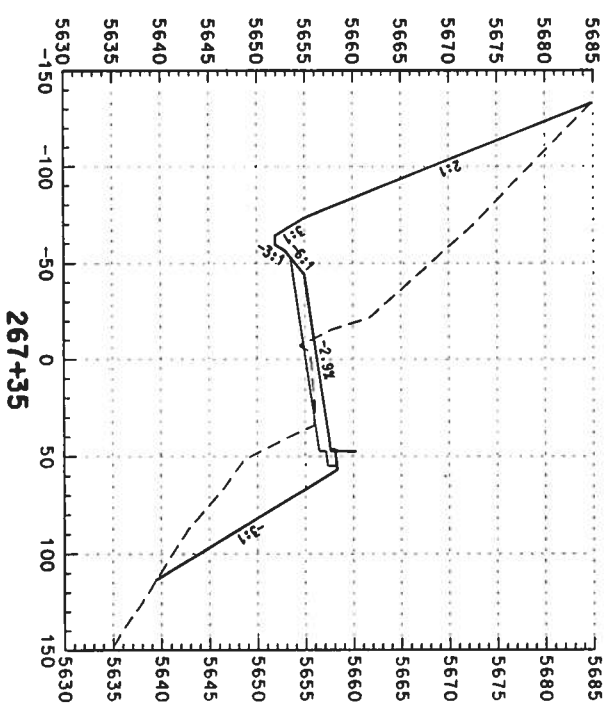
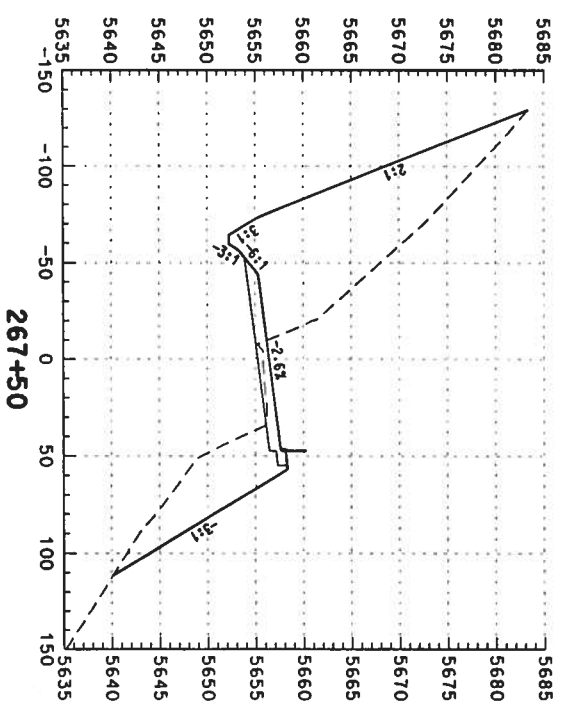
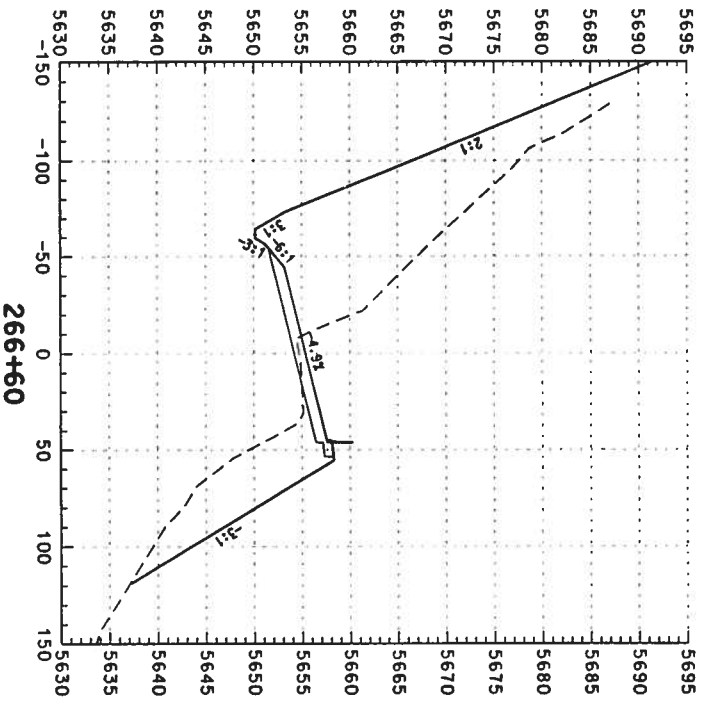
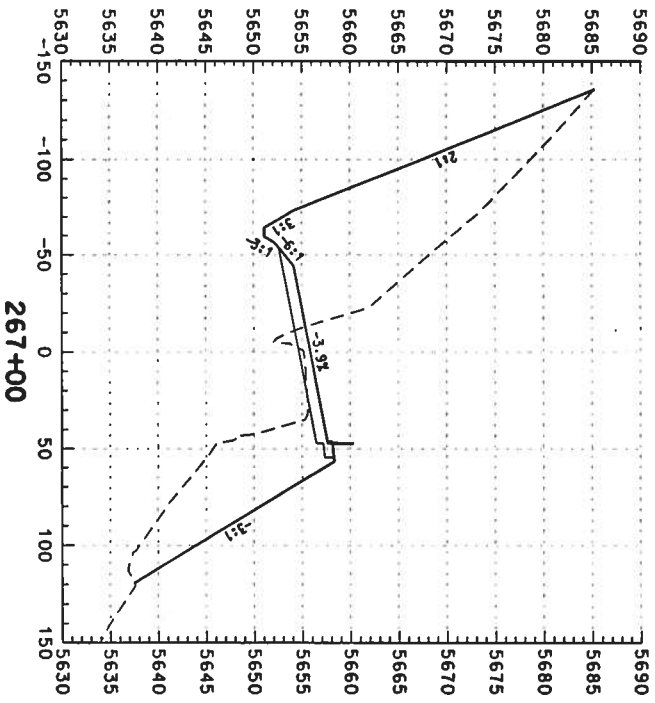

Computer File Information
 Creation Date: 02/14/03 Initials: DAF
 Last Modification Date: Initials:
 Full Path: S:\Tranpro\246042\2\HwyDes\Plans\
 Drawing File Name: rdxs-so-2d052.dgn
 Scale: Units: ENGLISH

Index of Revisions

DOT
 DEPARTMENT OF TRANSPORTATION
 REGION 1
 359 Inverness Dr. South
 Suite K
 Englewood, CO 80112
 Phone: (303) 790-1020
 Fax: (303) 790-1037

PBSJ
 5500 Greenwood Plaza Blvd.
 Suite 150
 Greenwood Village, CO 80111
 Phone: 303/221-7275
 Fax: 303/221/7276

As Constructed

No. Revisions:	
Revised:	
Void:	

US 85 CROSS SECTIONS

Designer: DAF
 Checker: DAF
 Sheet Subset: Roadway
 Subsheet Numbers:
 Subsheet Sheets: of

Project No./Code
 NH 0852-086
 13429
 Sheet Number: 351

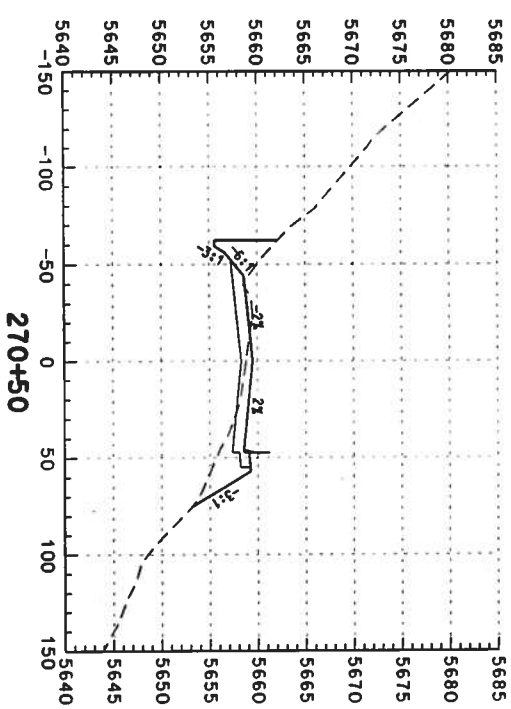
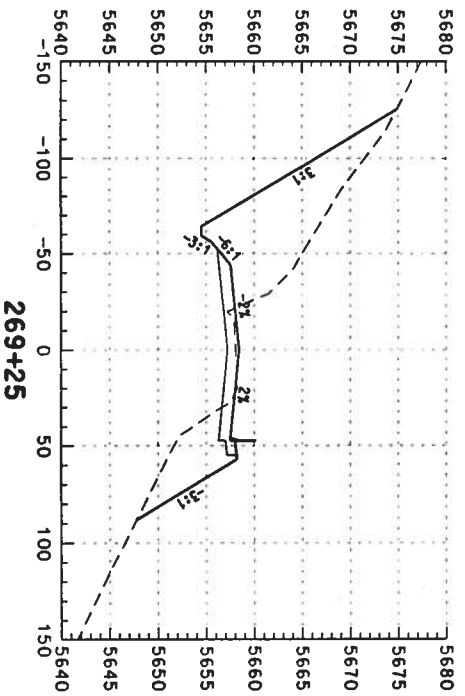
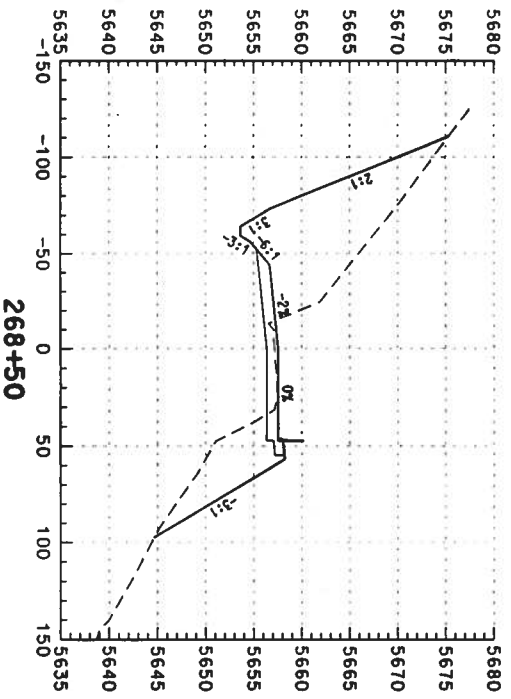
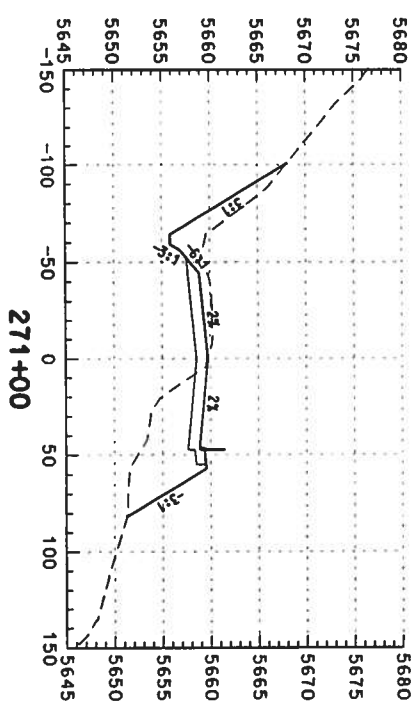
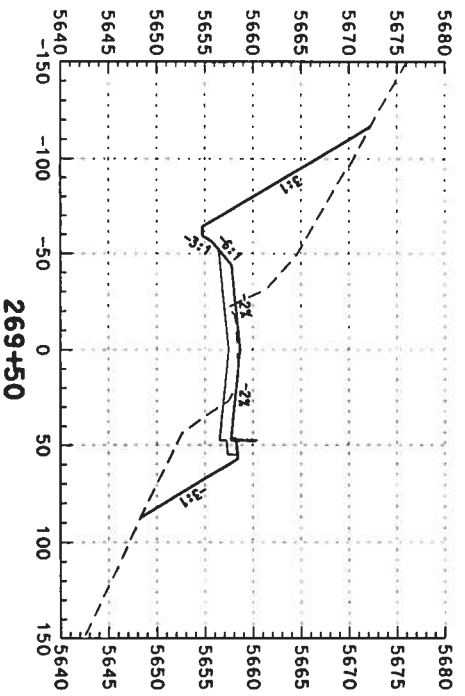
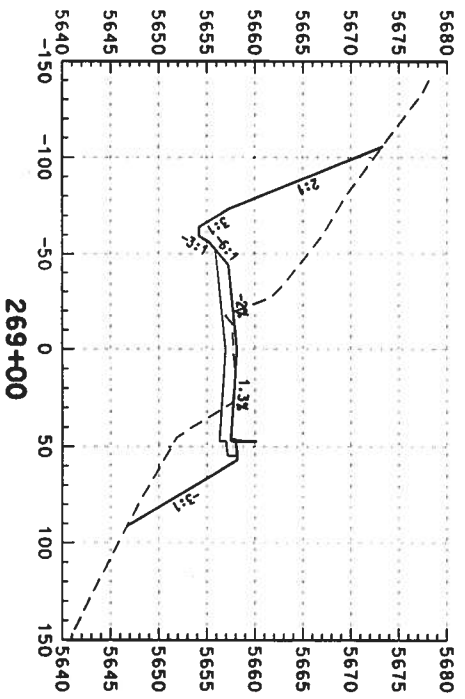
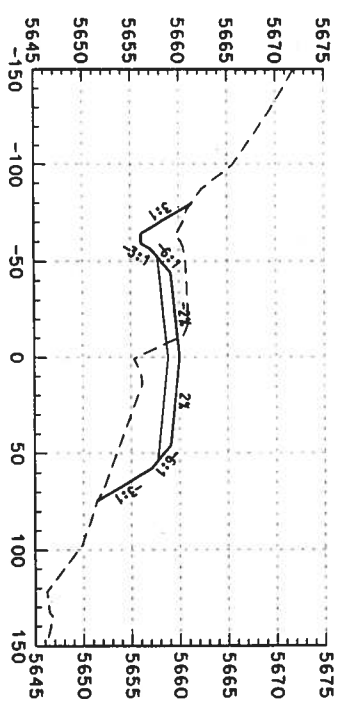
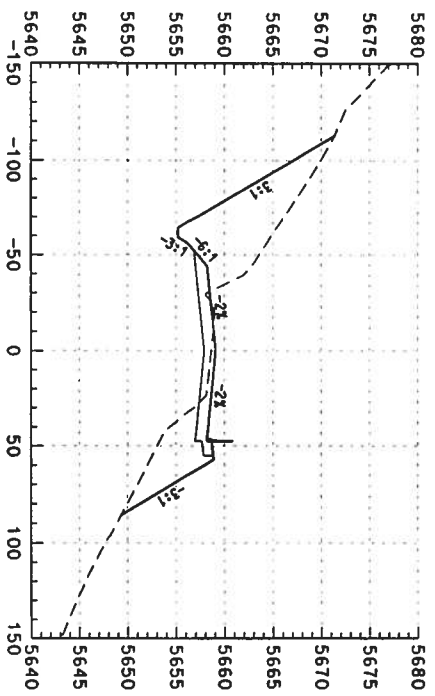

Computer File Information

Creation Date: 02/14/03 Initials: DAF
 Lost Modification Date: Initials:
 Full Path: S:\Tranproj\246042\HwyDes\Plans\
 Drawing File Name: rdxs-so-2d053.dgn
 Scale: Units: ENGLISH

Index of Revisions

No.	Description	Date	By



339 Inverness Dr. South
 Suite K
 Englewood, CO 80112
 Phone: (303) 790-1020
 Fax: (303) 790-1037



5500 Greenwood Plaza Blvd.
 Suite 150
 Greenwood Village, CO 80111
 Phone: 303/221-7275
 Fax: 303/221-7276

As Constructed

No. Revisions:	
Revised:	
Void:	

US 85 CROSS SECTIONS

Designer: DAF
 Detailer: DAF
 Sheet Subsets: Roadway

Structure Numbers
 Subsets Sheets: 01
 Sheet Number: 352

Project No./Code
 NH 0852-086

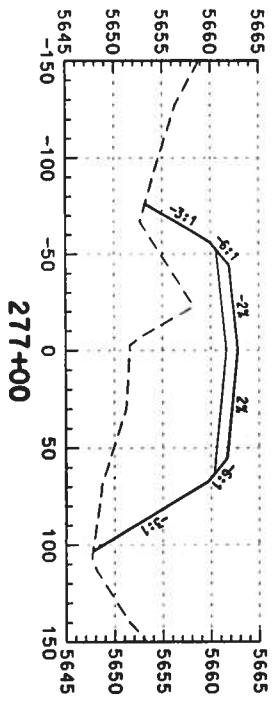
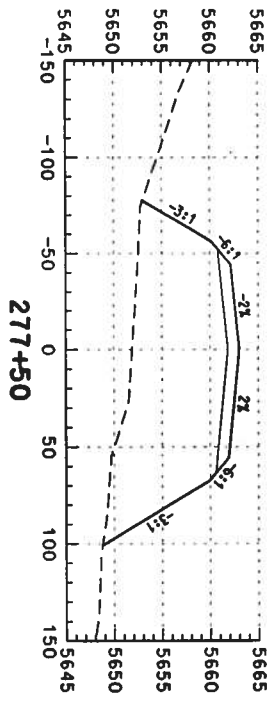
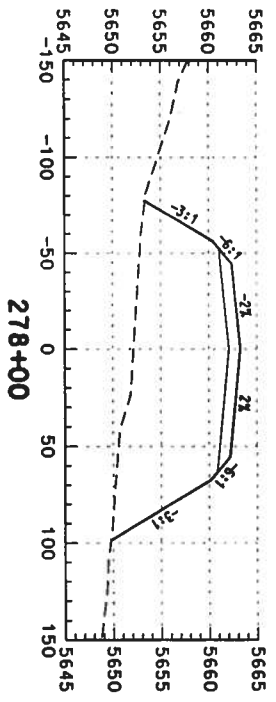
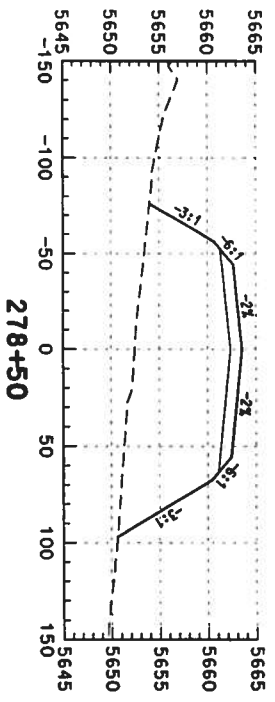
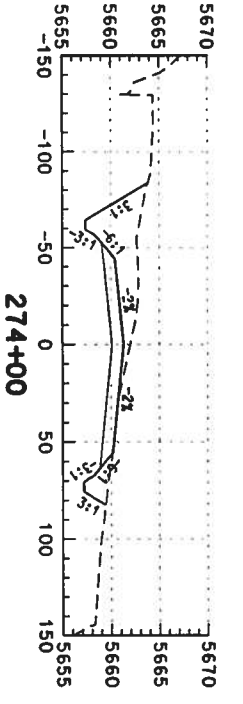
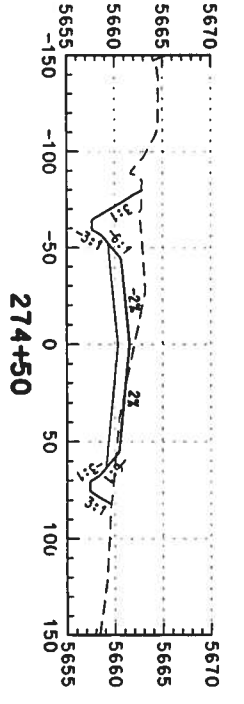
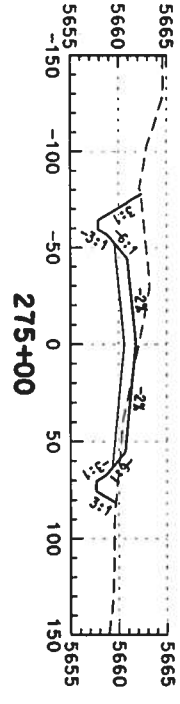
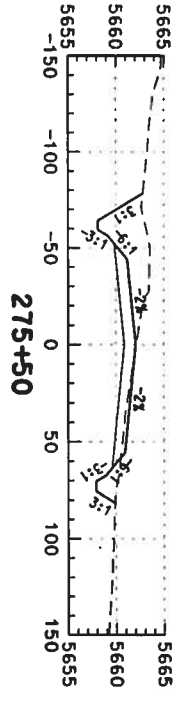
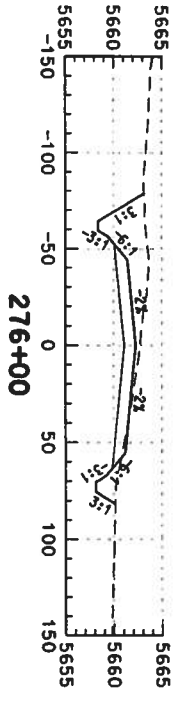
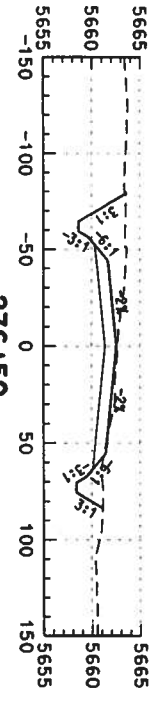
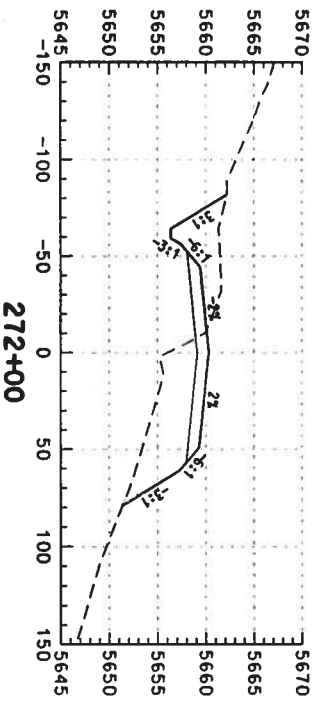
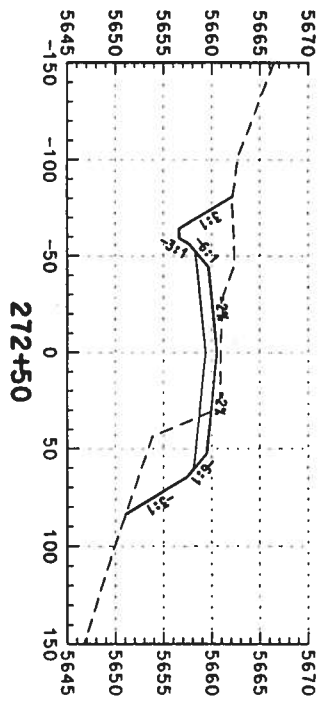
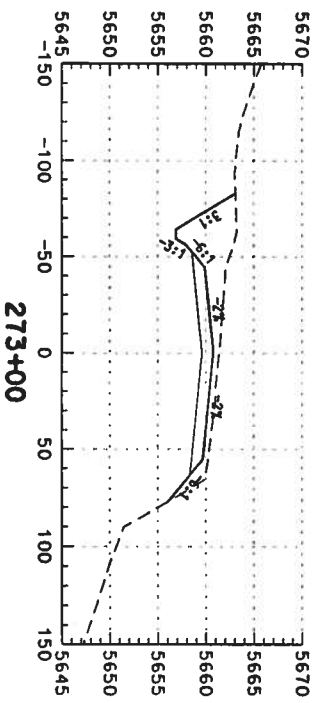
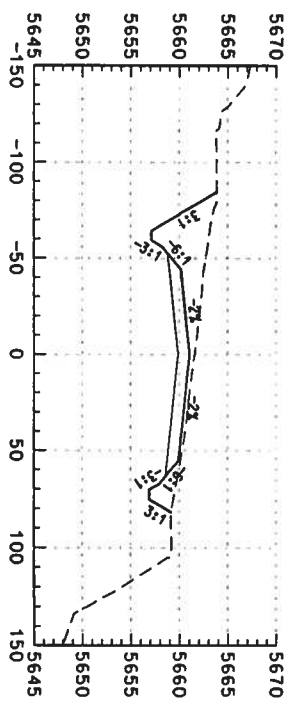

Computer File Information

Creation Date:	02/14/03	Initials:	DAF
Last Modification Date:		Initials:	
Full Path:	S:\Transport\246042\HWDes\Plans\		
Drawing File Name:	rdxs-so-20054.dgn		
Scale:	Units: ENGLISH		

Index of Revisions



359 Inverness Dr. South
Suite K
Englewood, CO 80112
Phone: (303) 790-1020
Fax: (303) 790-1037

REGION 1



5500 Greenwood Plaza Blvd.
Suite 150
Greenwood Village, CO 80111
Phone: 303/221-7275
Fax: 303/221-7276

As Constructed

No. Revisions:	
Revised:	
Void:	

US 85 CROSS SECTIONS

Designer:	DAF	Structure	
Detailer:	DAF	Numbers	
Sheet Subset:	Roadway	Subset Sheets:	of

Project No./Code

NH 0852-086
13429
Sheet Number: 353

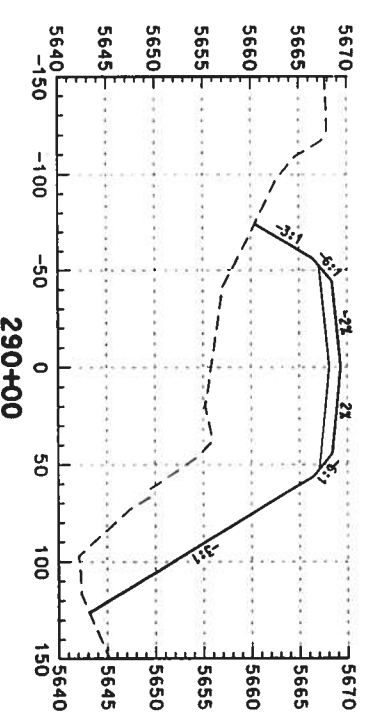
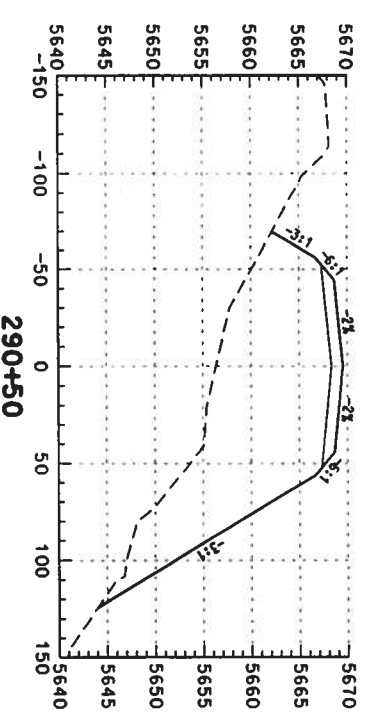
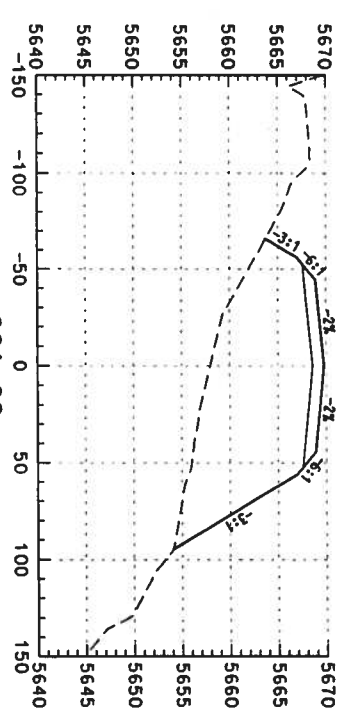
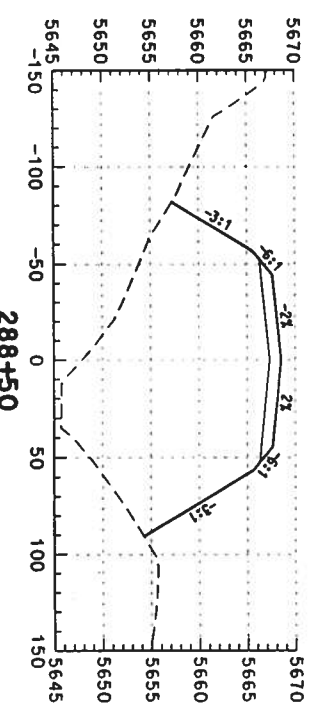
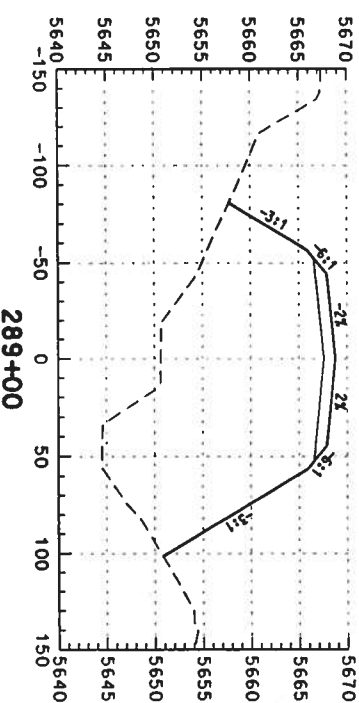
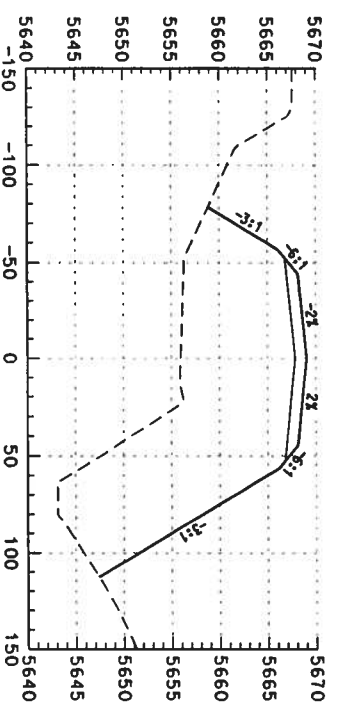
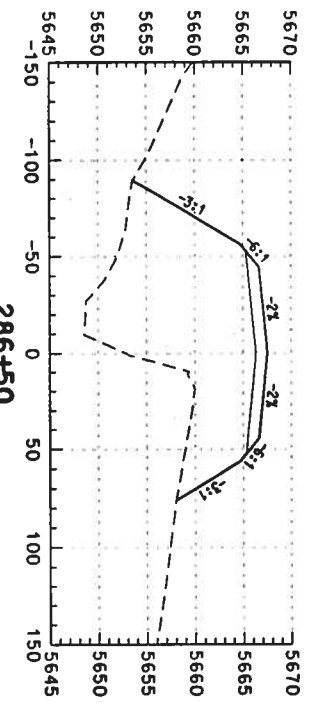
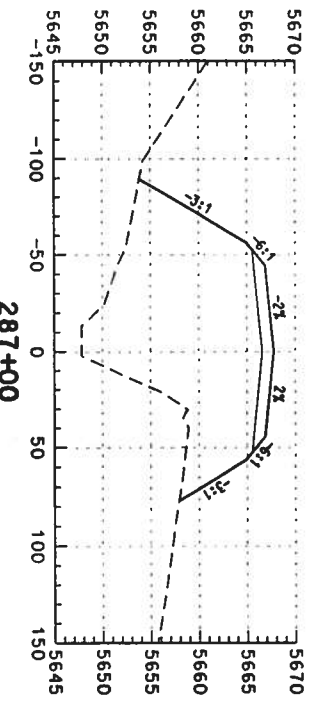
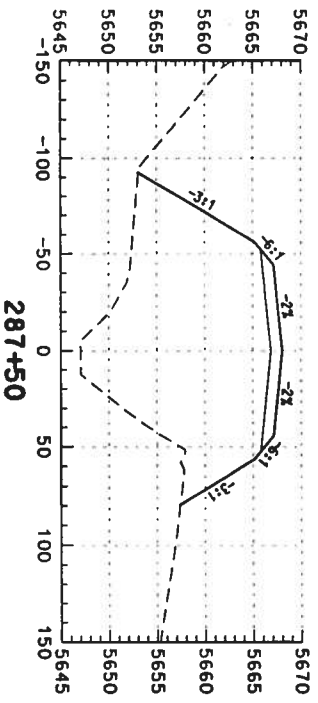
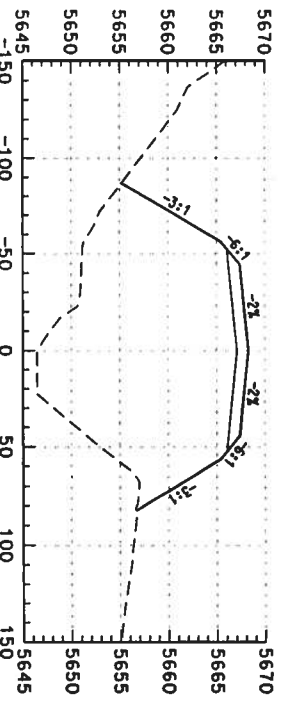

Computer File Information

Creation Date:	02/14/03	Initials:	DAF
Lost Modification Date:		Initials:	
Full Path:	S:\Tranpro\246042\HwyDes\Plans\		
Drawing File Name:	rdxs-so-24056.dgn		
Scale:	Units: ENGLISH		

Index of Revisions



359 Inverness Dr. South
Suite K
Englewood, CO 80112
Phone: (303) 790-1020
Fax: (303) 790-1037

REGION 1



5500 Greenwood Plaza Blvd.
Suite 150
Greenwood Village, CO 80111
Phone: 303/221-7275
Fax: 303/221-7276

As Constructed

No. Revisions:	
Revised:	
Void:	

US 85 CROSS SECTIONS

Designer:	DAF
Detailer:	DAF
Sheet Subset:	Roadway
Structure Numbers	
Subset Sheets:	of

Project No./Code

NH 0852-086
13429
Sheet Number: 355

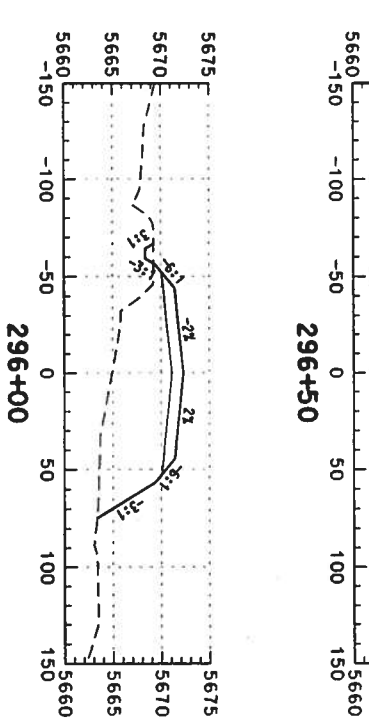
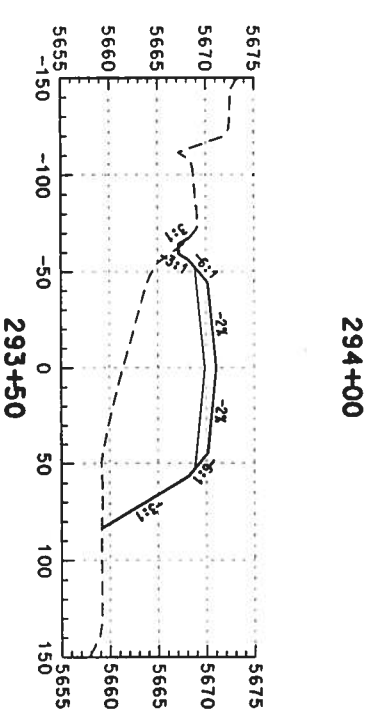
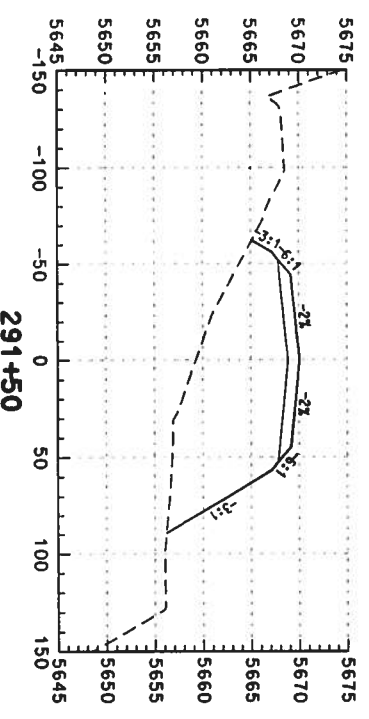
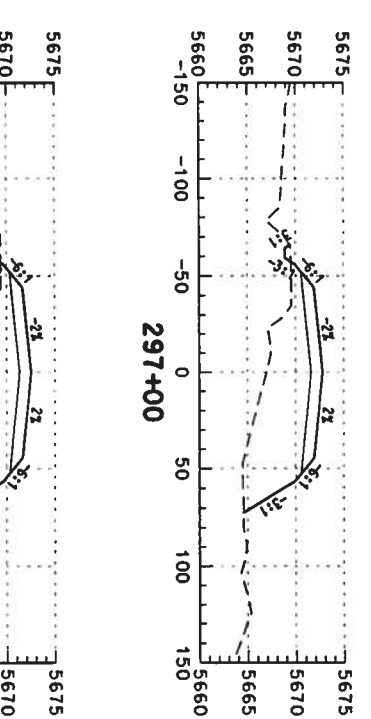
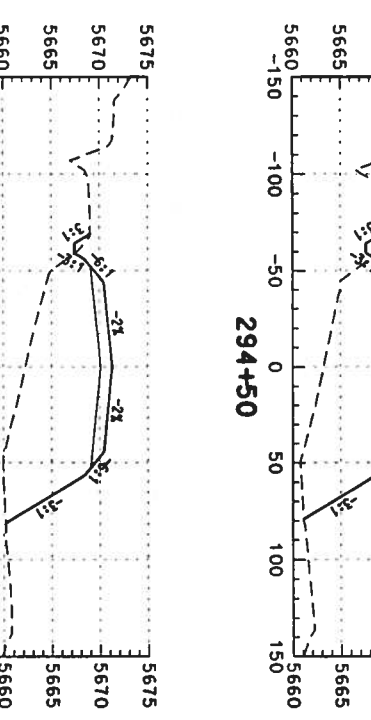
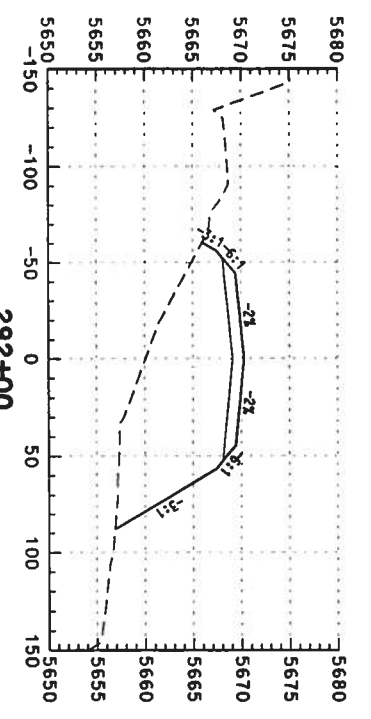
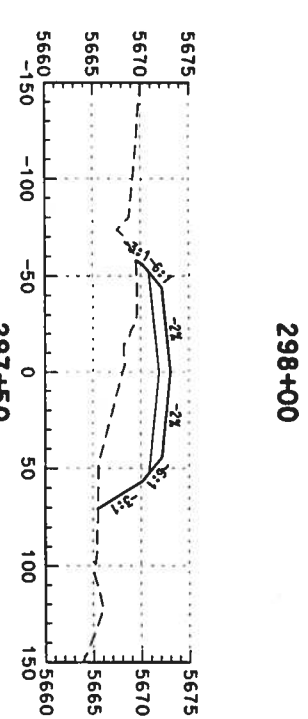
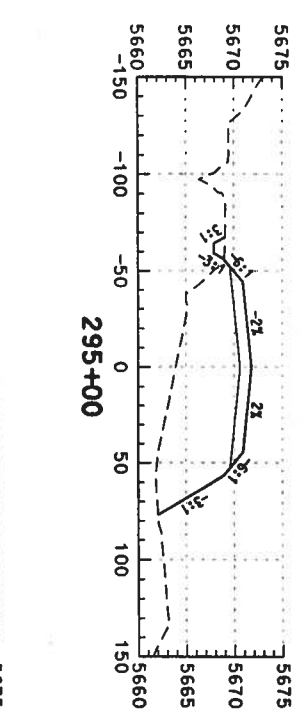
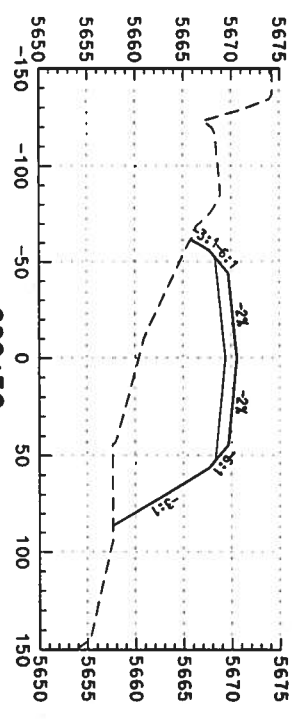
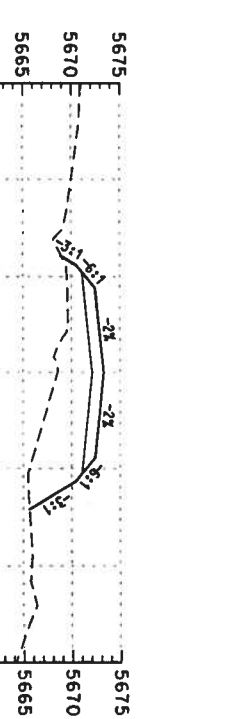
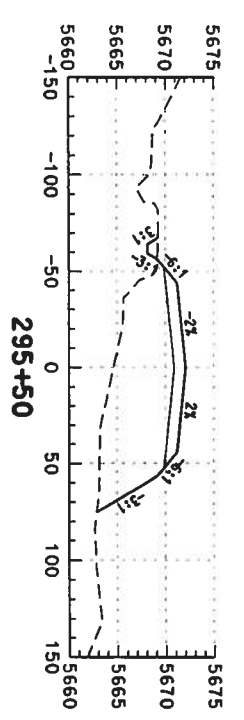
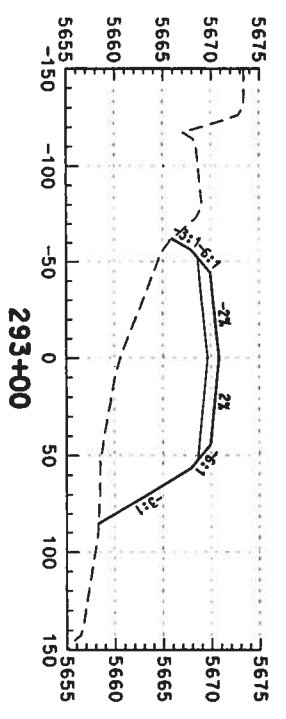

Computer File Information
 Creation Date: 02/14/03 Initials: DAF
 Last Modification Date: Initials:
 Full Path: S:\Transport\246042\HwyDes\Plans\
 Drawing File Name: rdxs-so-2d057.dgn
 Scale: Units: ENGLISH

Index of Revisions

DOT
 DEPARTMENT OF TRANSPORTATION
 359 Inverness Dr. South
 Suite K
 Englewood, CO 80112
 Phone: (303) 790-1020
 FAX: (303) 790-1037

PBS&J
 5500 Greenwood Plaza Blvd.
 Suite 150
 Greenwood Village, CO 80111
 Phone: 303/221-7275
 Fax: 303/221/7276

As Constructed
 No. Revisions:
 Revised:
 Void:

US 85 CROSS SECTIONS
 Designer: DAF
 Detailer: DAF
 Sheet Subset: Roadway
 Subset Sheets: of

Project No./Code
 NH 0852-086
 13429
 Sheet Number: 350

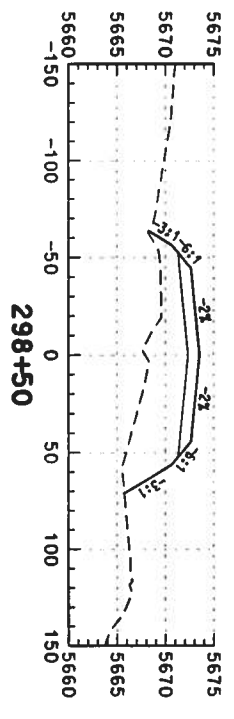
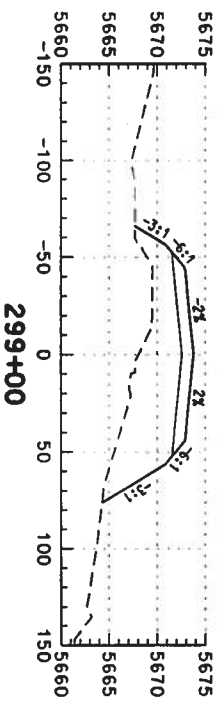
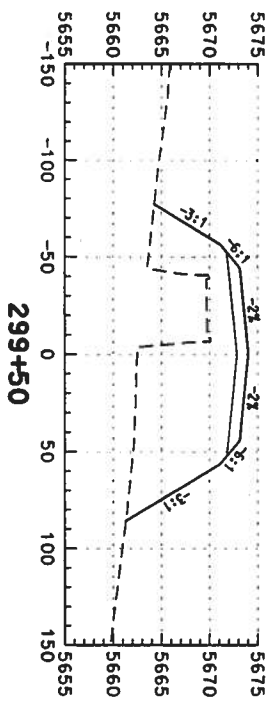
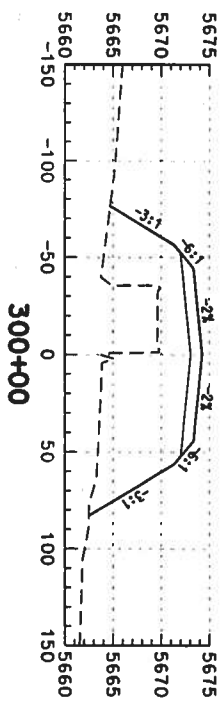

Computer File Information
 Creation Date: 02/14/03 Initials: DAF
 Lost Modification Date: Initials:
 Full Path: S:\Tranproj\246042\HwyDes\Plans\
 Drawing File Name: rdxs-so-24058.dgn
 Scale: Units: ENGLISH

Index of Revisions



359 Inverness Dr. South
 Suite K
 Englewood, CO 80112
 Phone: (303) 790-1020
 Fax: (303) 790-1037

REGION 1



5500 Greenwood Plaza Blvd.
 Suite 150
 Greenwood Village, CO 80111
 Phone: 303/221-7275
 Fax: 303/221-7276

As Constructed
 No. Revisions:
 Revised:
 Void:

US 85 CROSS SECTIONS
 Designer: DAF
 Detailer: DAF
 Sheet Subset: Roadway
 Structure Numbers
 Subset Sheets: of

Project No./Code
 NH 0852-086
 Sheet Number: 13429
 of 7

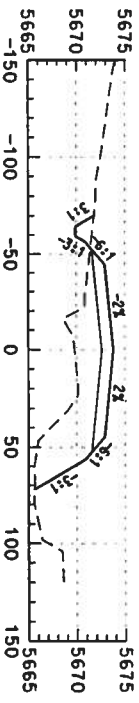

303+00

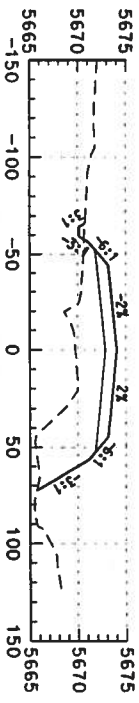

302+50

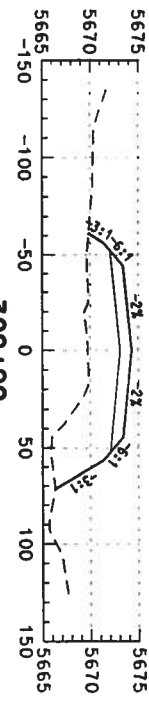

302+00

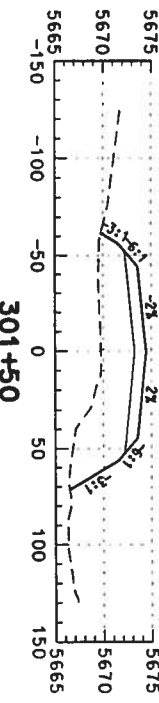

301+50

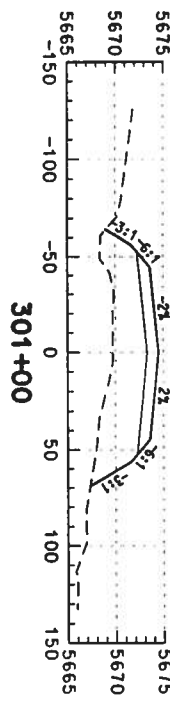

301+00

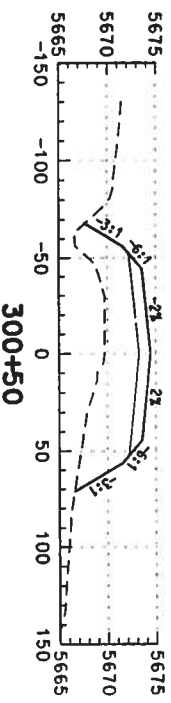

300+50

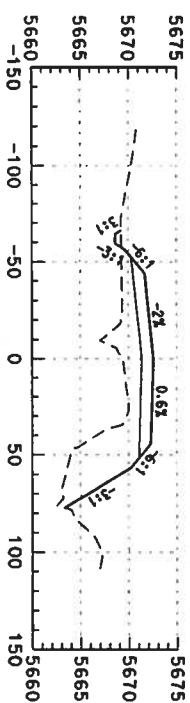

305+50

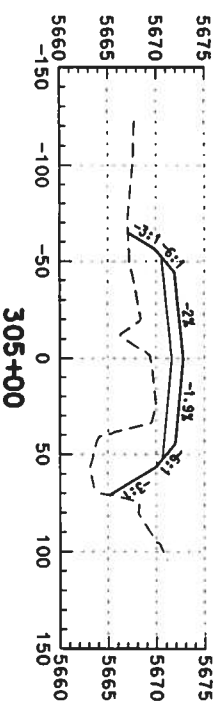

305+00

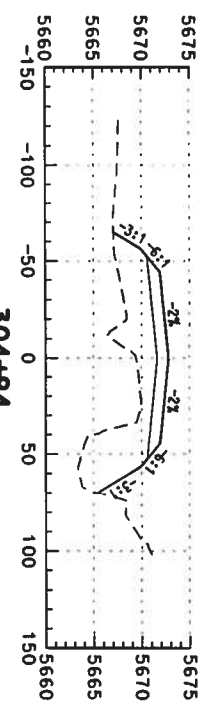

304+94

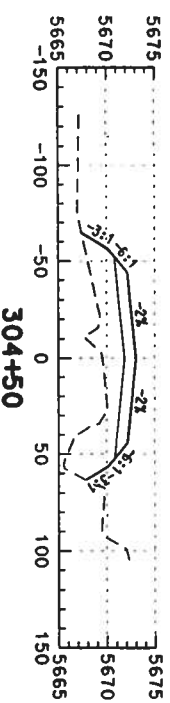

304+50

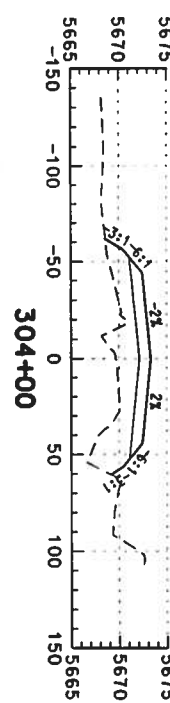

304+00

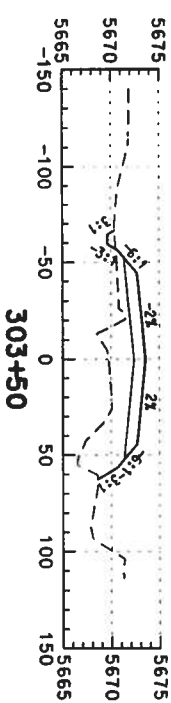

303+50

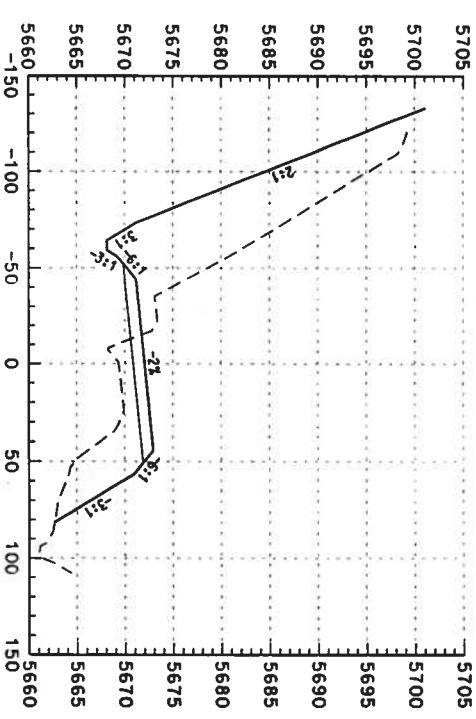

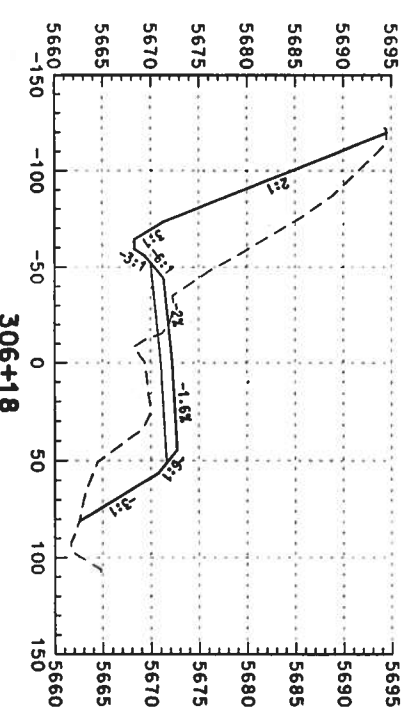

306+48

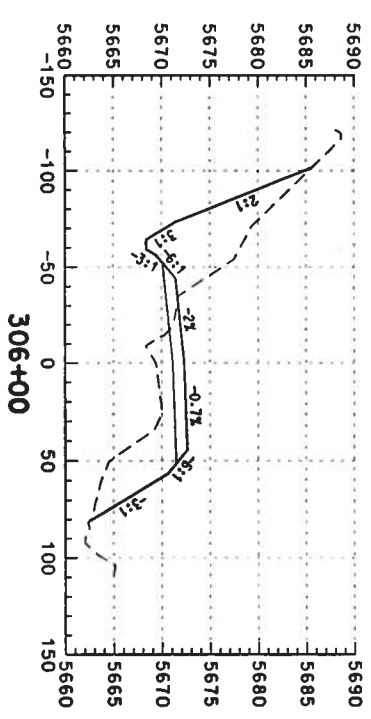

306+18



306+00

Computer File Information		Index of Revisions	
Creation Date:	02/14/03	Initials:	DAF
Last Modification Date:		Initials:	
Full Path:	S:\Transport\246042\246042\HWDes\Plans\rdxs-so-20059.dgn		
Drawing File Name:	rdxs-so-20059.dgn		
Scale:	Units: ENGLISH		
 359 Inverness Dr. South Suite K Englewood, CO 80112 Phone: (303) 790-1020 Fax: (303) 790-1037		 5500 Greenwood Plaza Blvd. Suite 150 Greenwood Village, CO 80111 Phone: 303/221-7275 Fax: 303/221/7276	
As Constructed		US 85 CROSS SECTIONS	
No. Revisions:		Designer:	DAF
Revised:		Detailer:	DAF
Void:		Sheet Subset:	Roadway
		Structure Numbers:	
		Subset Sheets:	
		of	
Project No./Code		Sheet Number:	
NH 0852-086		13429	
		358	

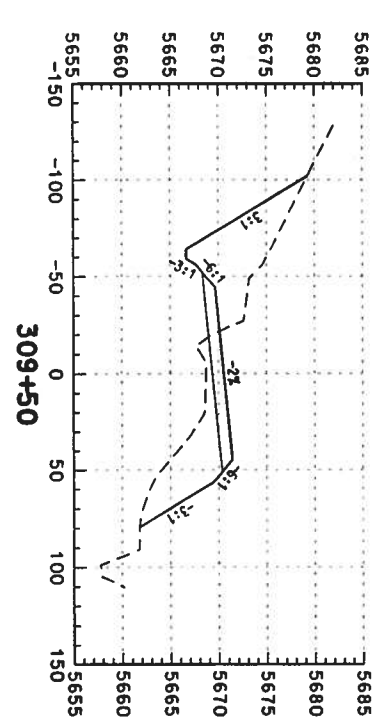
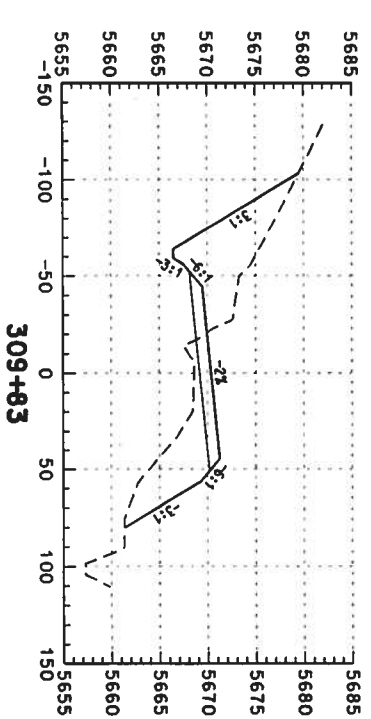
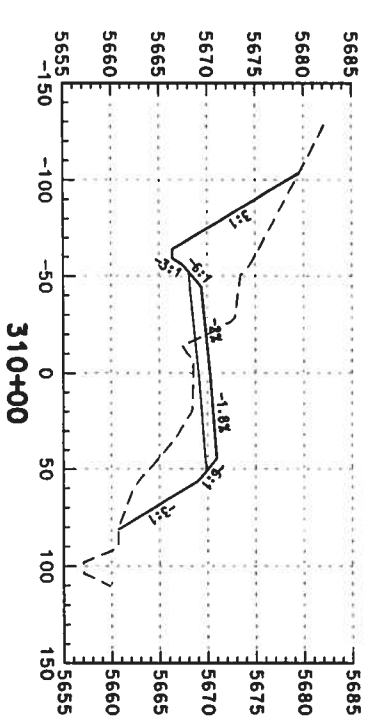
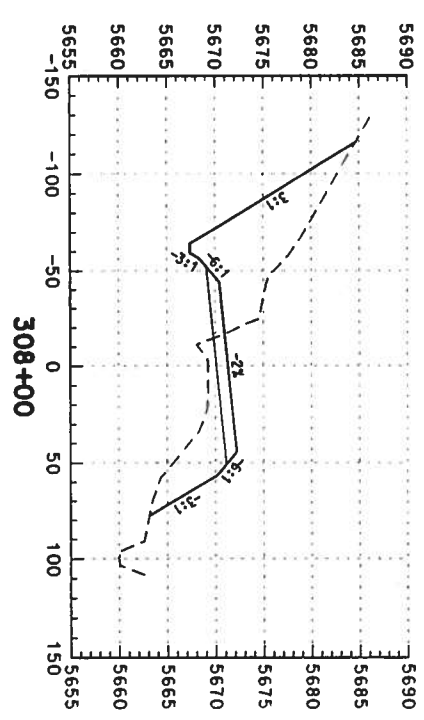
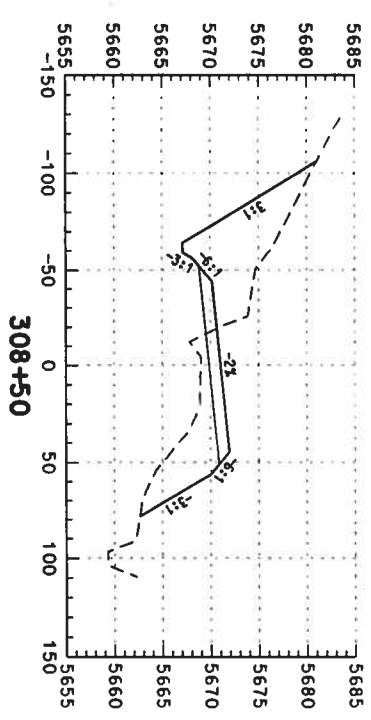
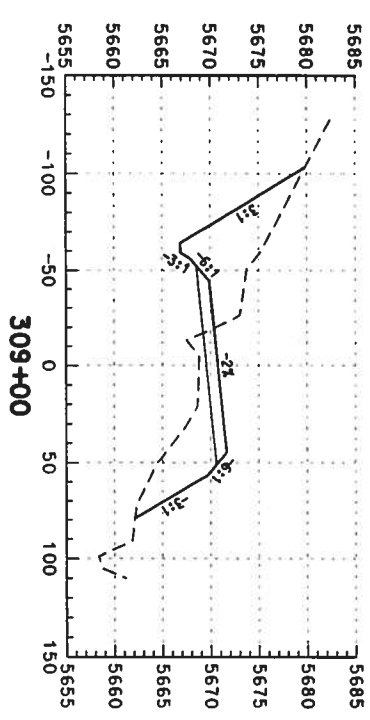
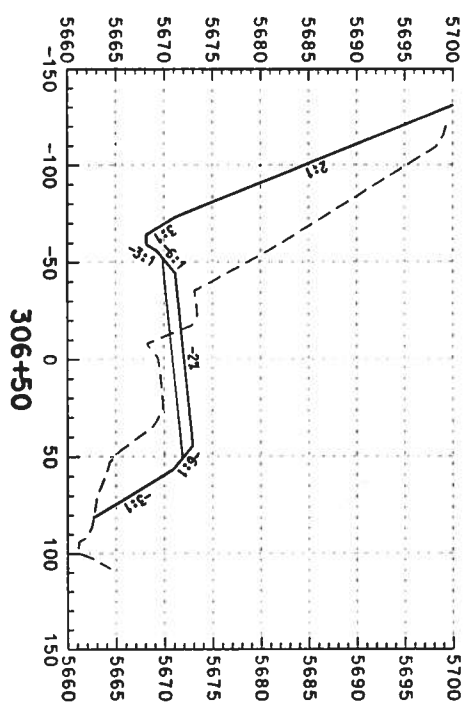
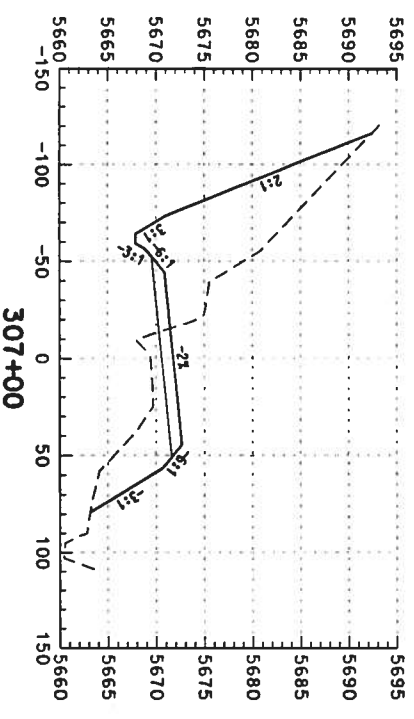
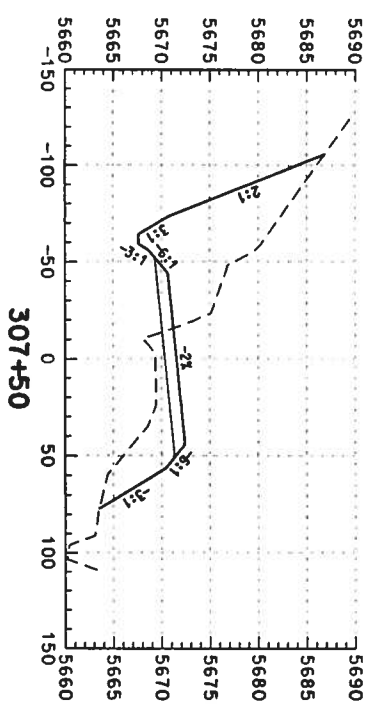

Computer File Information

Creation Date:	02/14/03	Initials:	DAF
Last Modification Date:		Initials:	
Full Path:	S:\Trompro\246042.12\HydDes\Plans\		
Drawing File Name:	rdxs-so-2d060.dgn		
Scale:	Units: ENGLISH		

Index of Revisions

DOT
DEPARTMENT OF TRANSPORTATION

359 Iverness Dr. South
Suite K
Englewood, CO 80112
Phone: (303) 790-1020
Fax: (303) 790-1037

PBSJ

5500 Greenwood Plaza Blvd.
Suite 150
Greenwood Village, CO 80111
Phone: 303/221-7275
Fax: 303/221/7276

REGION I

As Constructed

No. Revisions:	
Revised:	
Void:	

US 85 CROSS SECTIONS

Designer:	DAF
Detailer:	DAF
Sheet Subset:	Roadway
Structure Numbers:	
Subset Sheets:	

Project No./Code

NH 0852-086
13429
Sheet Number: 359

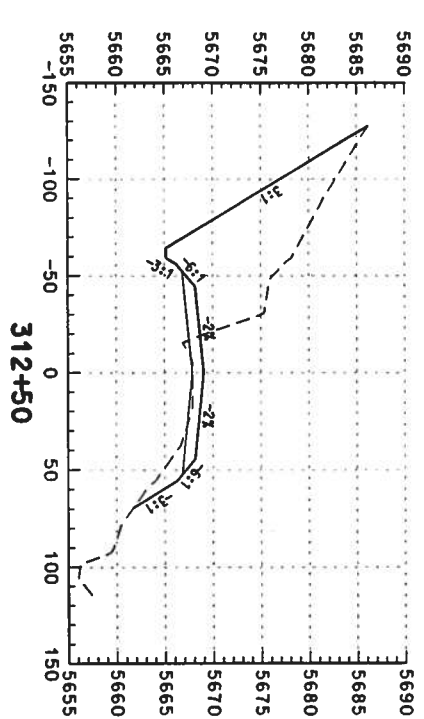
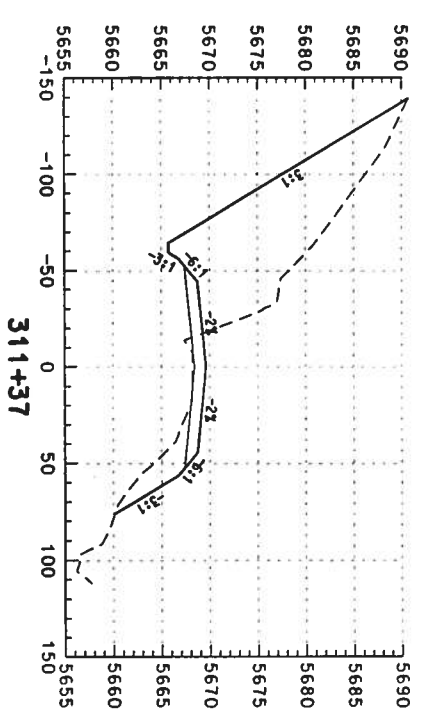
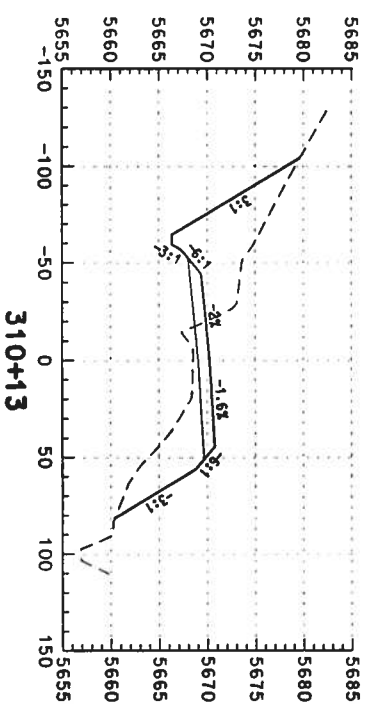
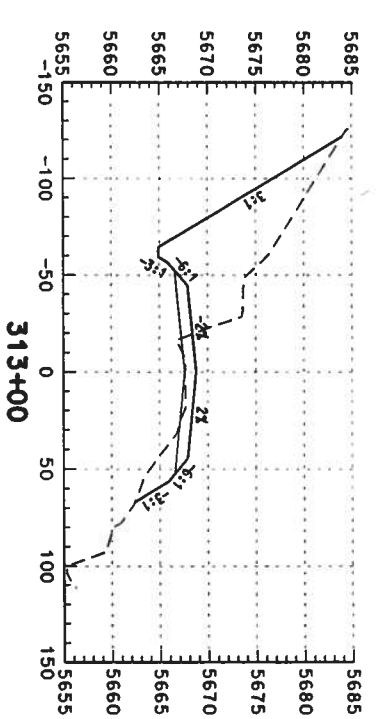
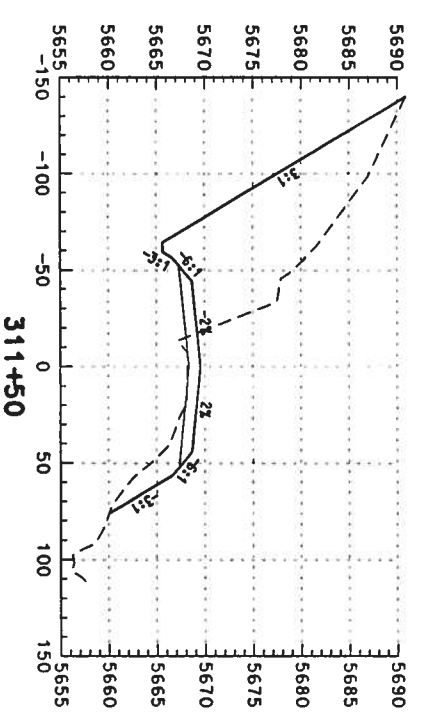
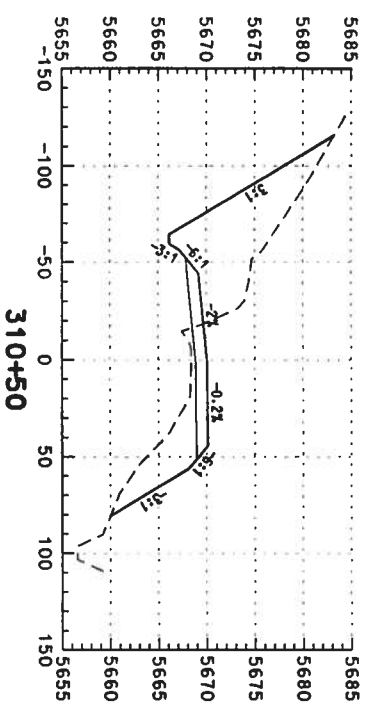
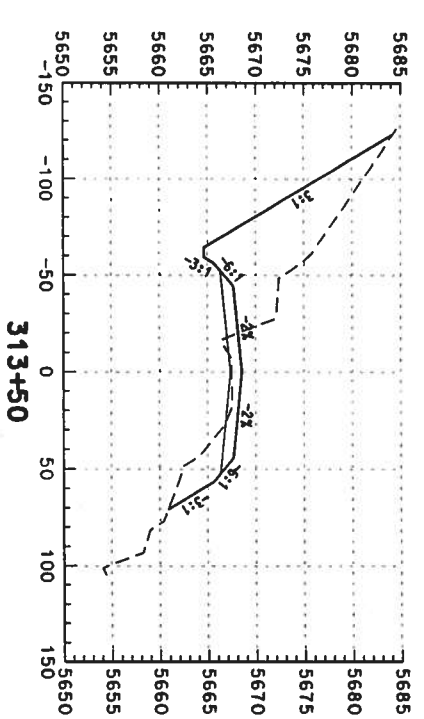
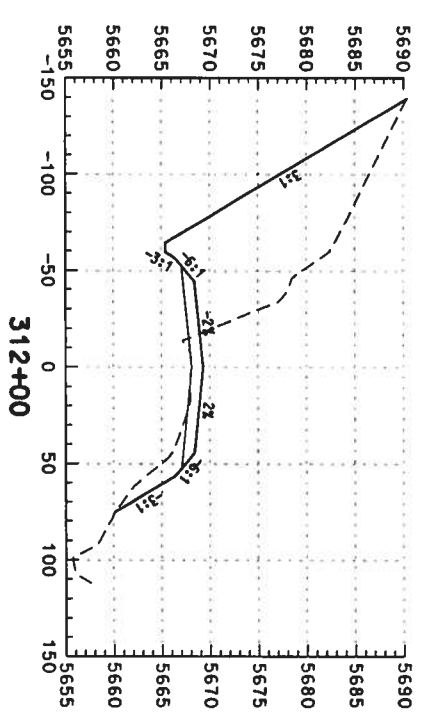
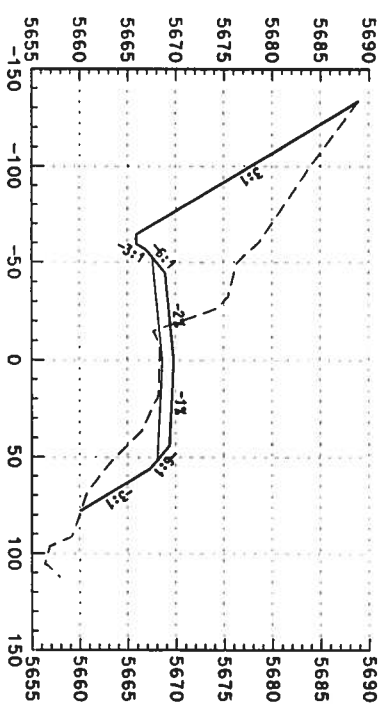

Computer File Information
 Creation Date: 02/14/03 Initials: DAF
 Last Modification Date: Initials:
 Full Path: S:\Transport\246042\2\Hydres\Plans\
 Drawing File Name: rdxs-so-2d061.dgn
 Scale: Units: ENGLISH

Index of Revisions

DOT
 DEPARTMENT OF TRANSPORTATION
 REGION 1
 359 Inverness Dr., South
 Suite K
 Englewood, CO 80112
 Phone: (303) 790-1020
 FAX: (303) 790-1037

PBSJ
 5500 Greenwood Plaza Blvd.
 Suite 150
 Greenwood Village, CO 80111
 Phone: 303/721-7275
 Fax: 303/721/7276

As Constructed
 No. Revisions:
 Revised:
 Void:

US 85 CROSS SECTIONS
 Designer: DAF
 Detailer: DAF
 Sheet Subset: Roadway
 Subset Sheets: of

Project No./Code
 NH 0852-086
 13429
 Sheet Number: 300

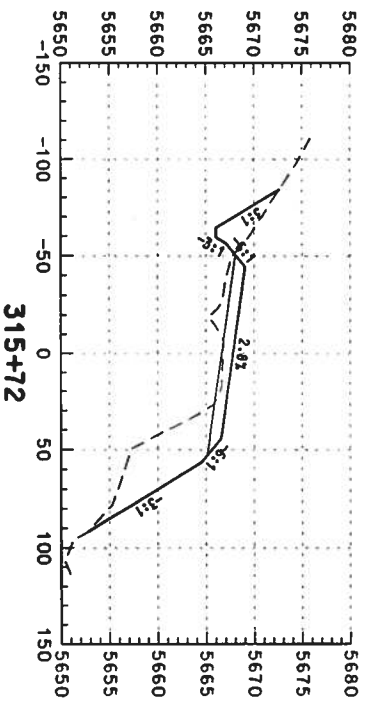
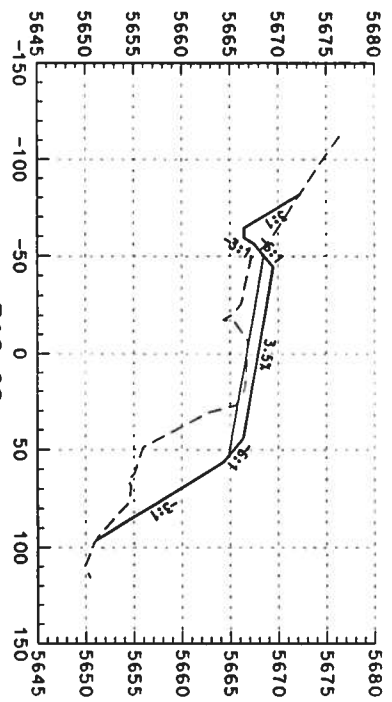
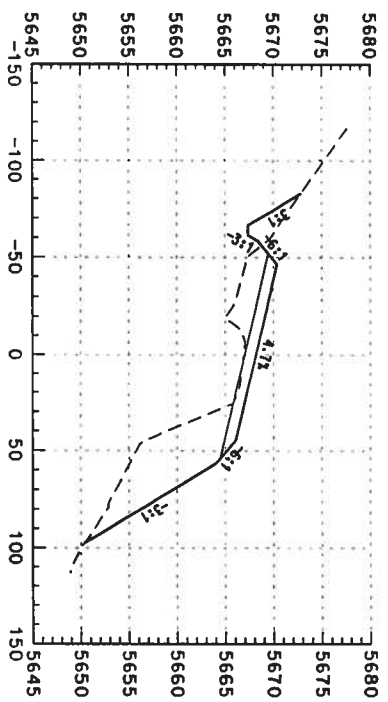
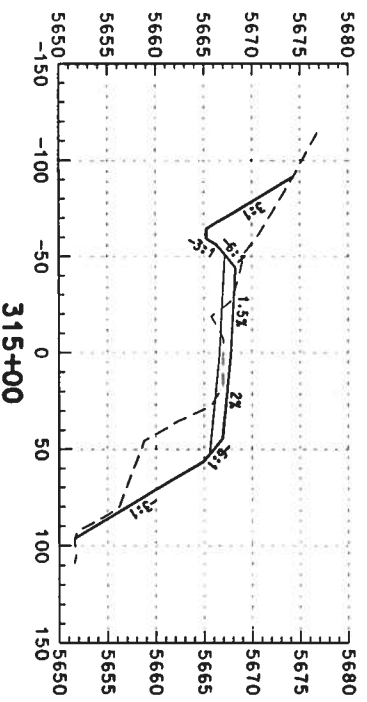
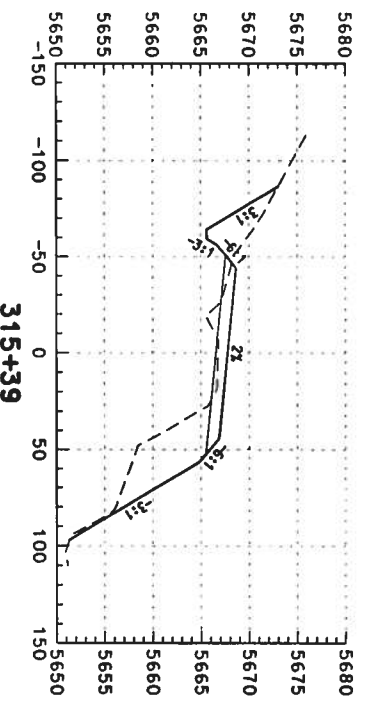
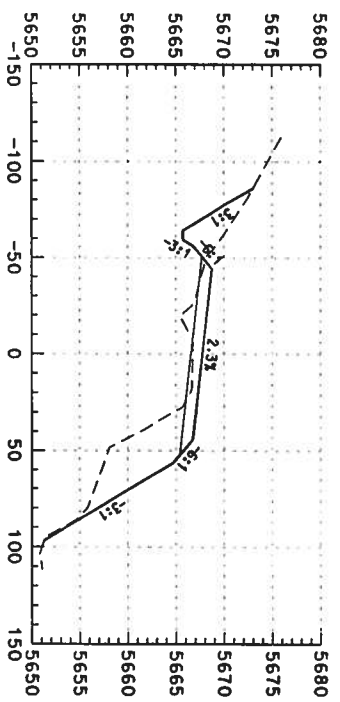
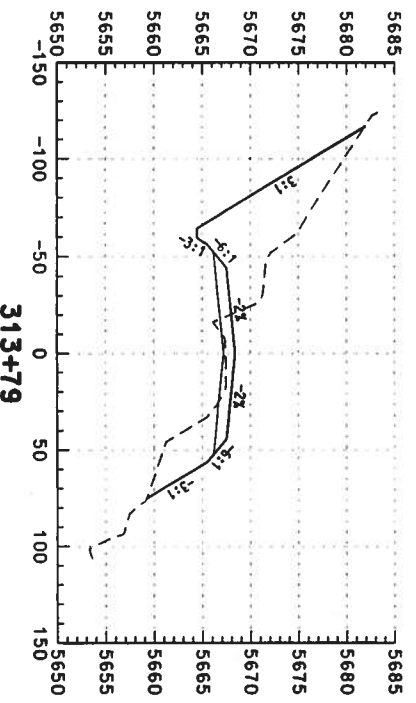
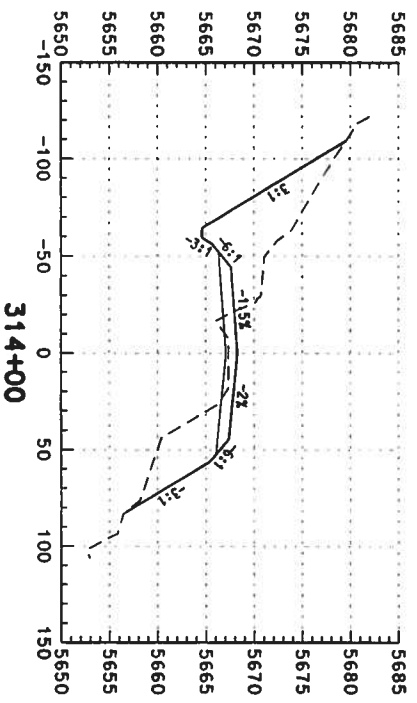
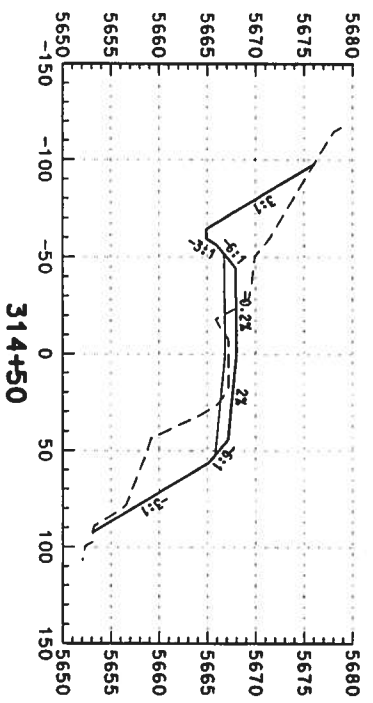

Computer File Information
 Creation Date: 02/14/03 Initials: DAF
 Last Modification Date: Initials:
 Full Path: S:\Transport\246042.HwyDes\Plans\
 Drawing File Name: rdxs-so-24062.dgn
 Scale: Units: ENGLISH

Index of Revisions

DOT
 DEPARTMENT OF TRANSPORTATION
 359 Inverness Dr. South
 Suite K
 Englewood, CO 80112
 Phone: (303) 790-1020
 FAX: (303) 790-1037

PBSJ
 5500 Greenwood Plaza Blvd.
 Suite 150
 Greenwood Village, CO 80111
 Phone: 303/221-7275
 Fax: 303/221-7276

REGION 1

As Constructed

No. Revisions:
 Revised:
 Void:

US 85 CROSS SECTIONS

Designer: DAF
 Detailer: DAF
 Sheet Subset: Roadway

Structure Numbers
 Subset Sheets: of

Project No./Code
 NH 0852-086
 13429
 Sheet Number: 301

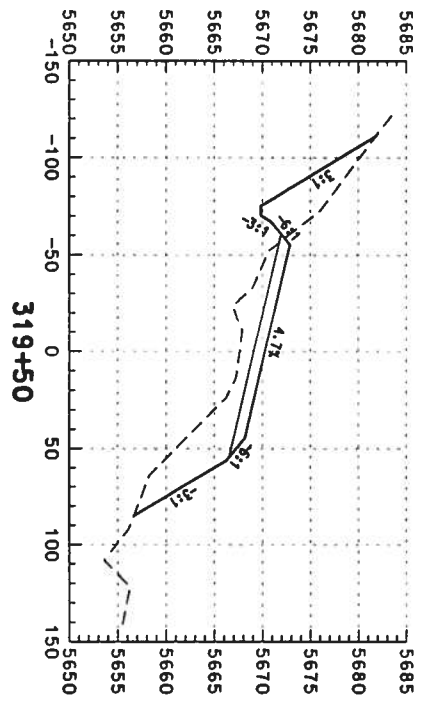
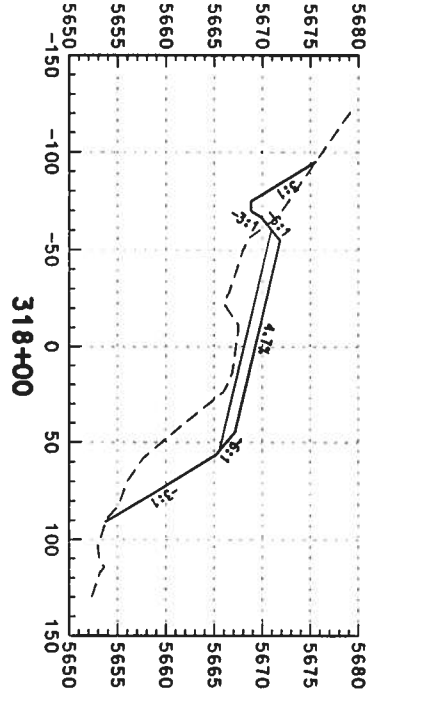
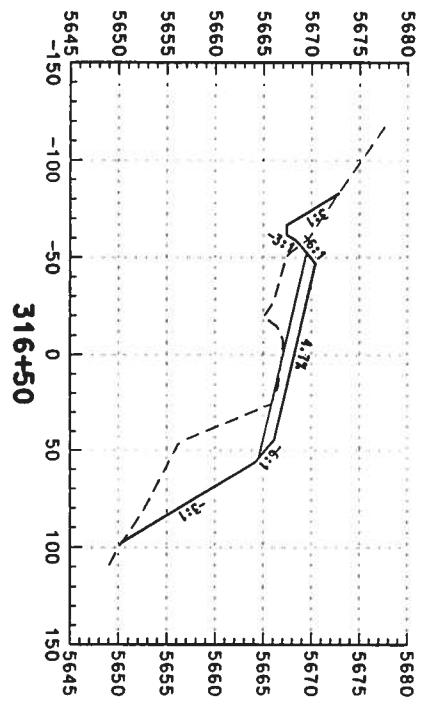
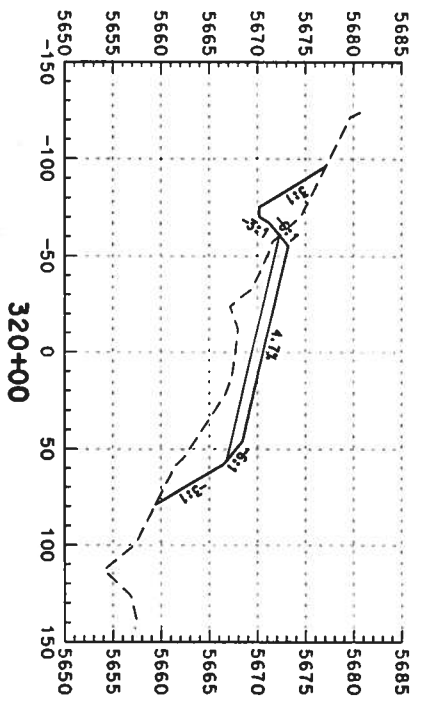
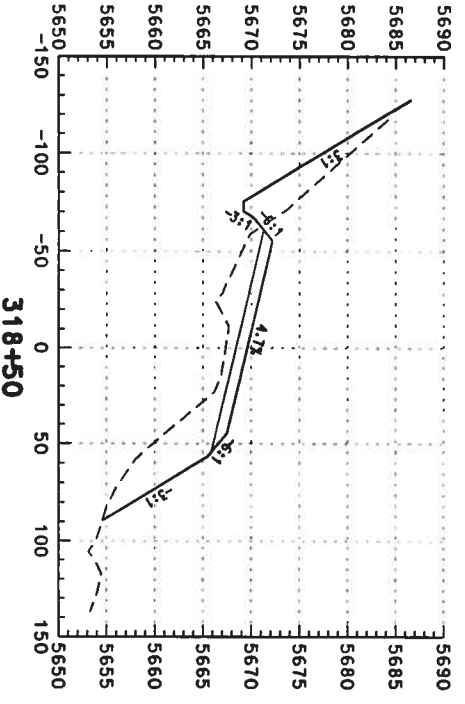
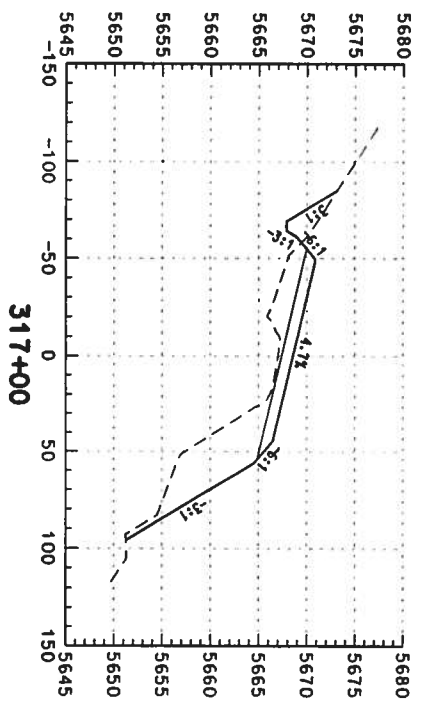
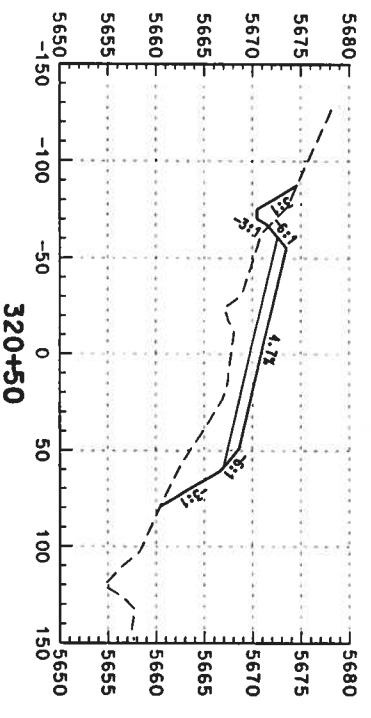
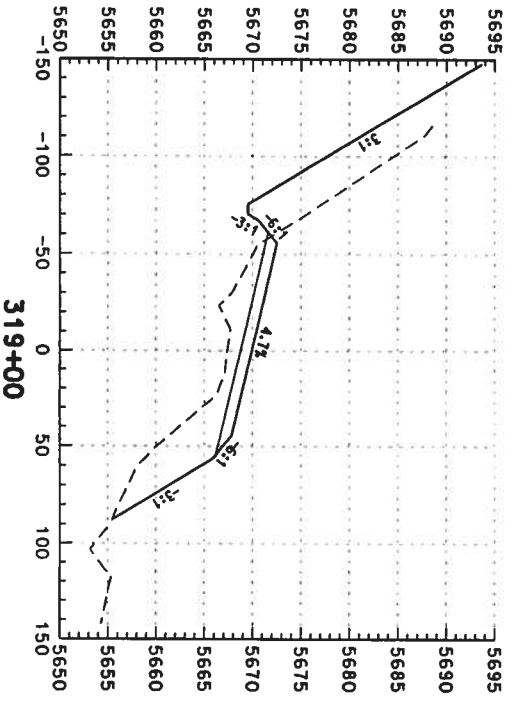
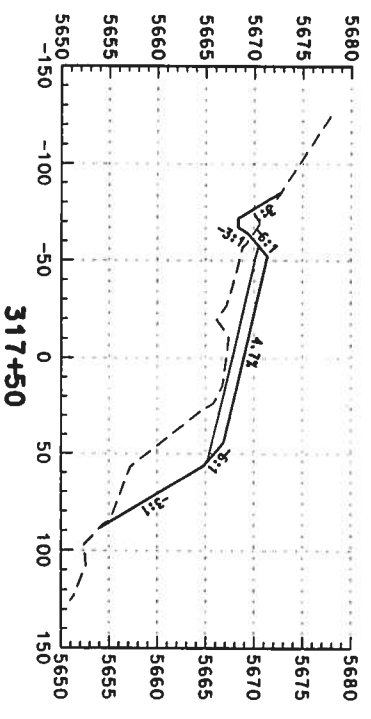

Computer File Information

Creation Date: 02/14/03 Initials: DAF
 Last Modification Date: Initials:
 Full Path: S:\Temp\proj\246042\246042\HWYDes\Plans\
 Drawing File Name: rdxs-so-24063.dgn
 Scale: Units: ENGLISH

Index of Revisions



339 Inverness Dr. South
 Suite K
 Englewood, CO 80122
 Phone: (303) 790-1020
 FAX: (303) 790-1037

REGION 1



5300 Greenwood Plaza Blvd.
 Suite 150
 Greenwood Village, CO 80111
 Phone: 303/221-7275
 Fax: 303/221-7276

As Constructed

No. Revisions: _____
 Revised: _____
 Void: _____

US 85 CROSS SECTIONS

Designer: DAF
 Detailer: DAF
 Sheet Subset: Roadway

Project No./Code
 NH 0852-086
 Sheet Number: 13429
 of 362

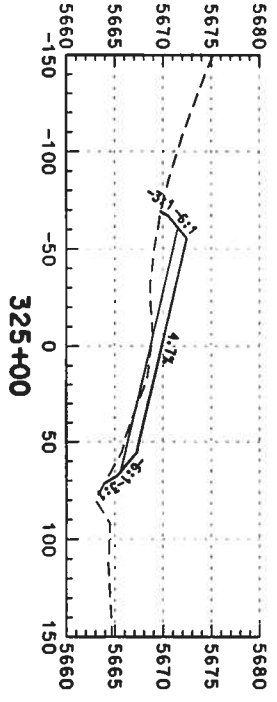
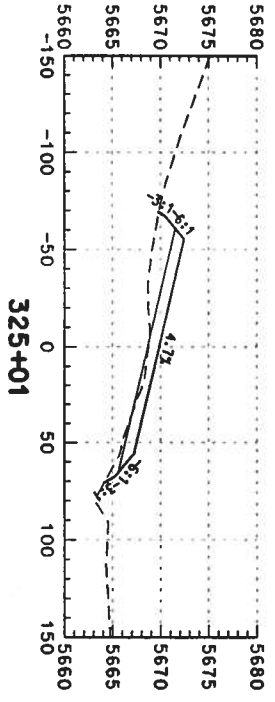
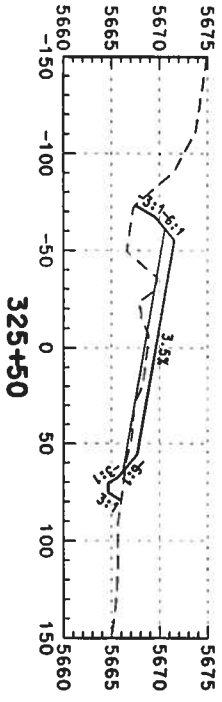
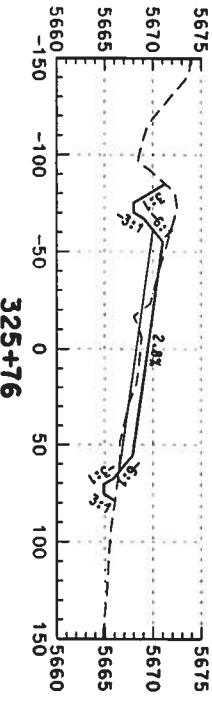
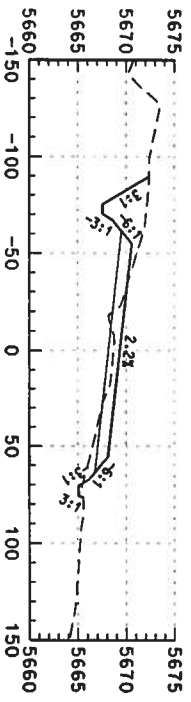
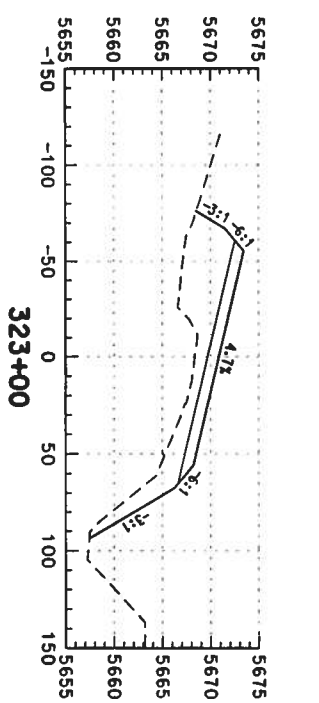
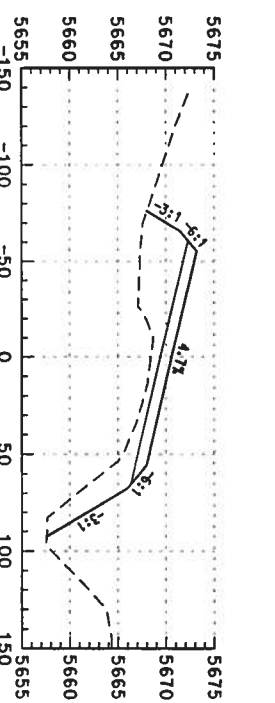
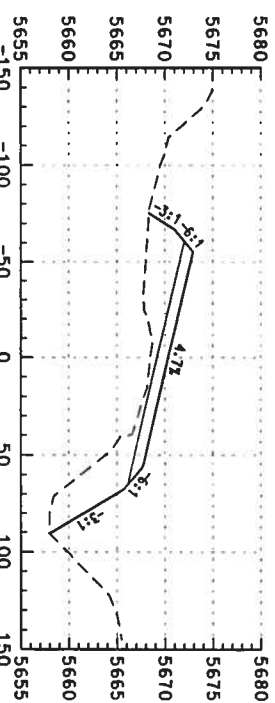
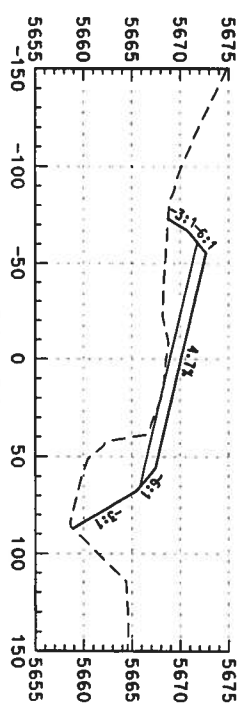
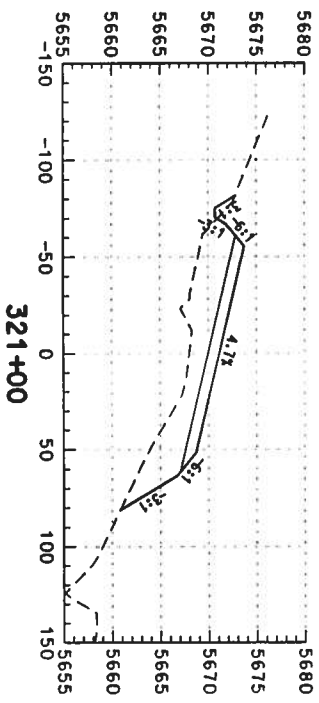
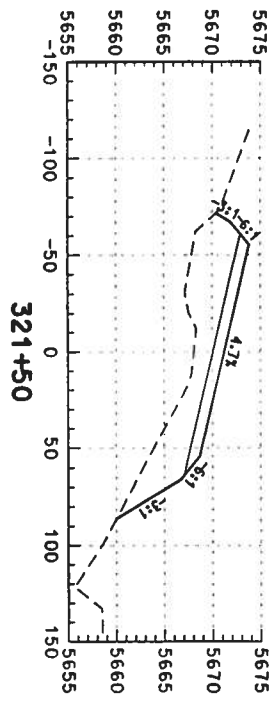
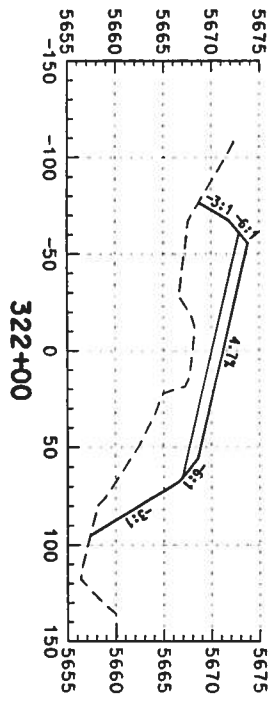
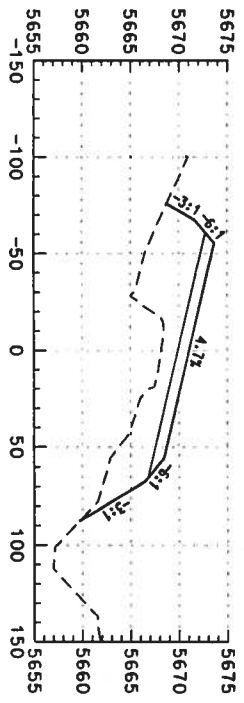

Computer File Information
 Creation Date: 02/14/03 Initials: DAF
 Last Modification Date: Initials:
 Full Path: S:\Transport\246042\HW\Des\Plans\
 Drawing File Name: rdxs-so-2d064.dgn
 Scale: Units: ENGLISH

Index of Revisions

DOT
 DEPARTMENT OF TRANSPORTATION
 REGION 1
 359 Inverness Dr. South
 Suite K
 Englewood, CO 80112
 Phone: (303) 790-1020
 Fax: (303) 790-1037

PBS&J
 5500 Greenwood Plaza Blvd.
 Suite 150
 Greenwood Village, CO 80111
 Phone: 303/221-1775
 Fax: 303/221/7276

As Constructed
 No. Revisions:
 Revised:
 Void:

US 85 CROSS SECTIONS
 Designer: DAF
 Detailer: DAF
 Sheet Subset: Roadway
 Structure Numbers:
 Subset Sheets: of

Project No./Code
 NH 0852-086
 13429
 Sheet Number: 363

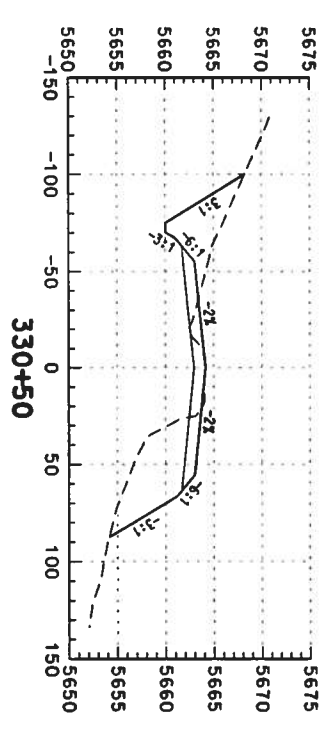
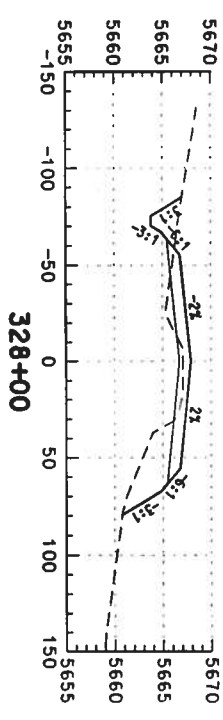
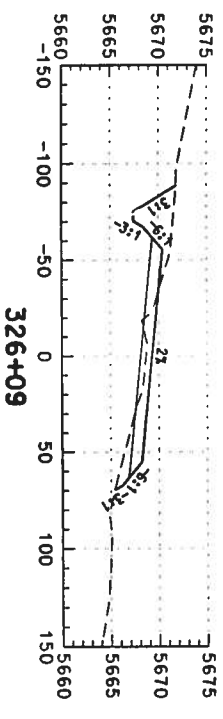
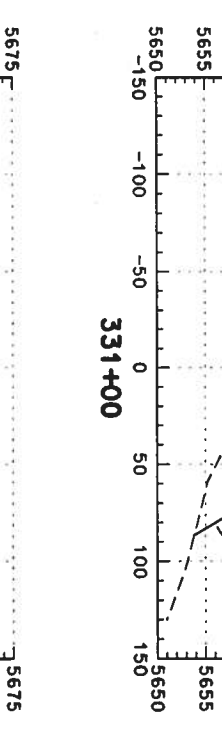
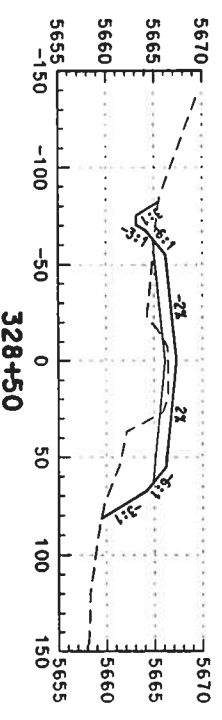
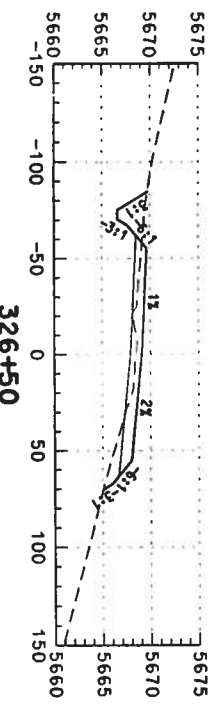
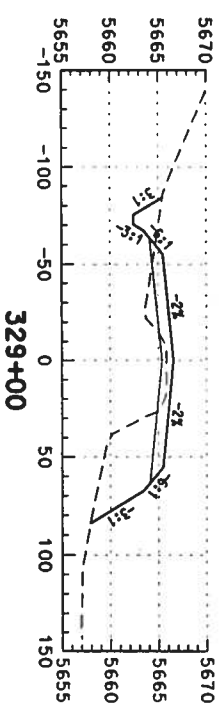
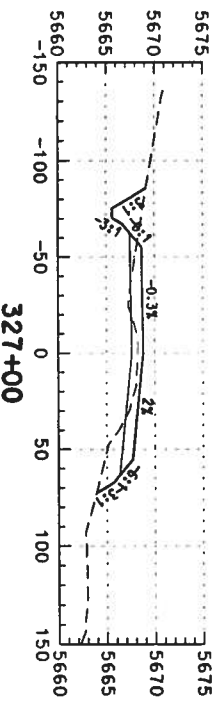
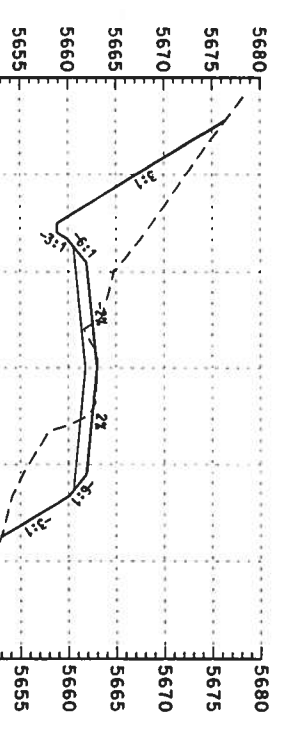
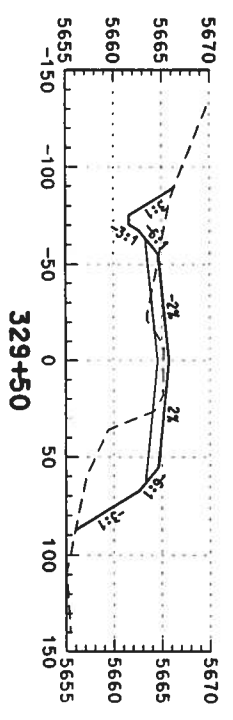
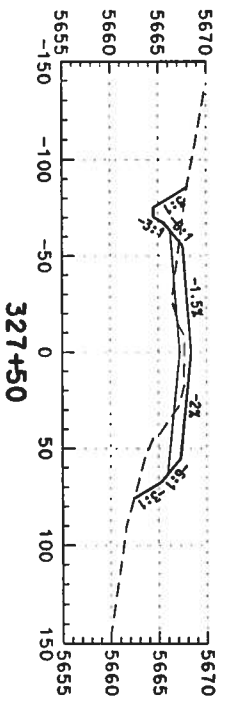
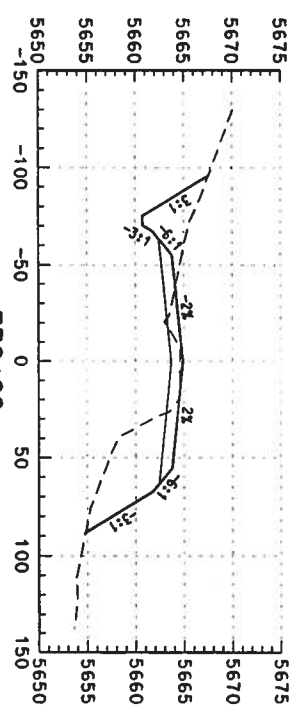
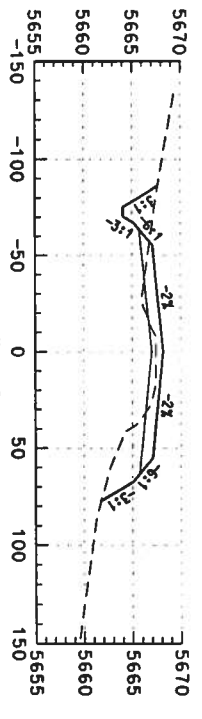

Computer File Information	
Creation Date:	02/14/03
Initials:	DAF
Lost Modification Date:	
Initials:	
Full Path:	S:\Trampro\ 246042\Hydres\Plans\
Drawing File Name:	rdxs-so-2d065.dgn
Scale:	Units: ENGLISH

Index of Revisions	

DOT
 DEPARTMENT OF TRANSPORTATION
 REGION 1
 359 Inverness Dr. South
 Suite K
 Englewood, CO 80112
 Phone: (303) 790-1020
 Fax: (303) 790-1037

PBSJ
 5500 Greenwood Plaza Blvd.
 Suite 150
 Greenwood Village, CO 80111
 Phone: 303/221-7275
 Fax: 303/221-7276

As Constructed	
No. Revisions:	
Revised:	
Void:	

US 85 CROSS SECTIONS			
Designer:	DAF	Structure	
Detailer:	DAF	Numbers	
Sheet Subset:	Roadway	Subset Sheets:	
			of

Project No./Code	
NH 0852-086	
Sheet Number:	13429
	304

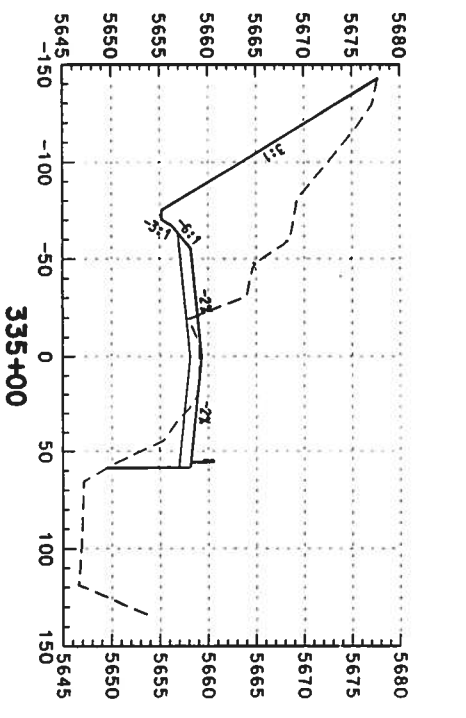
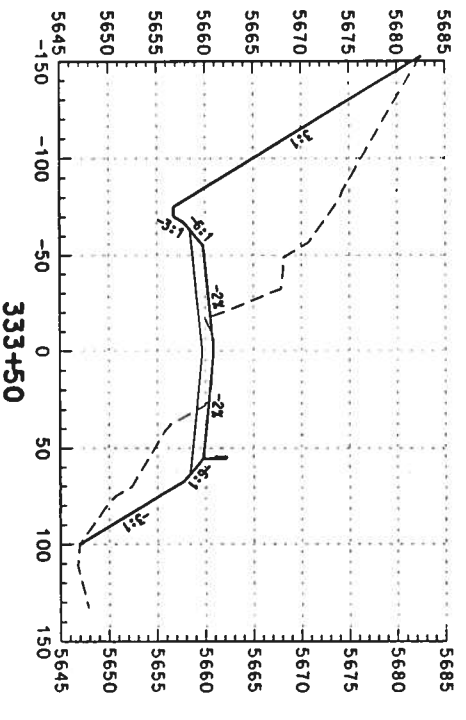
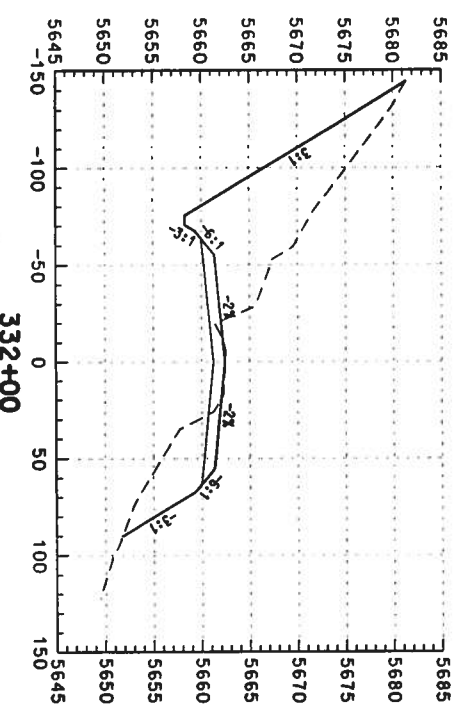
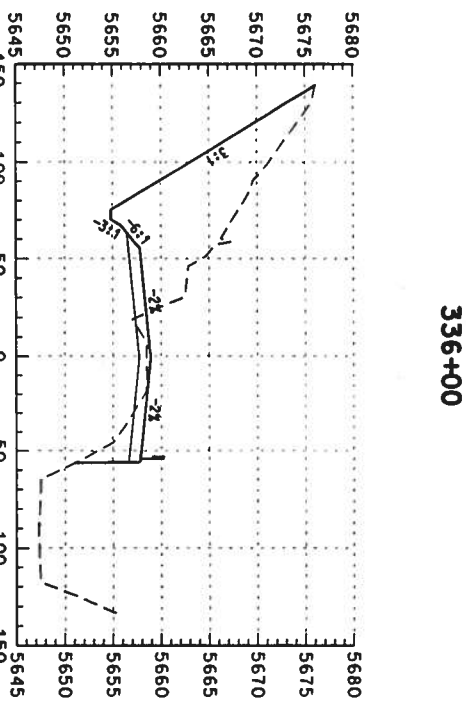
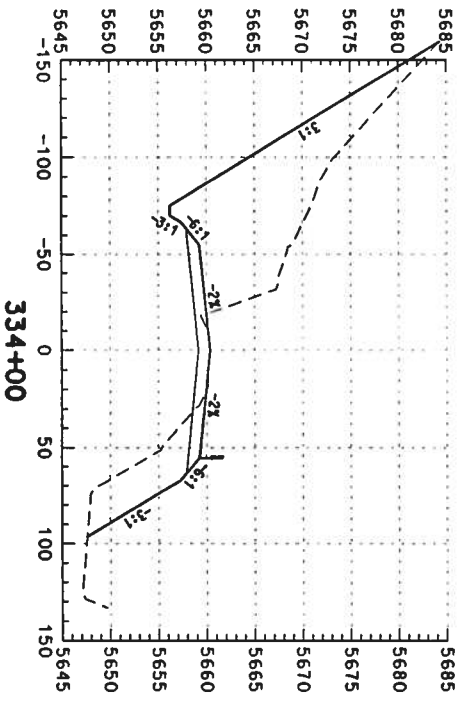
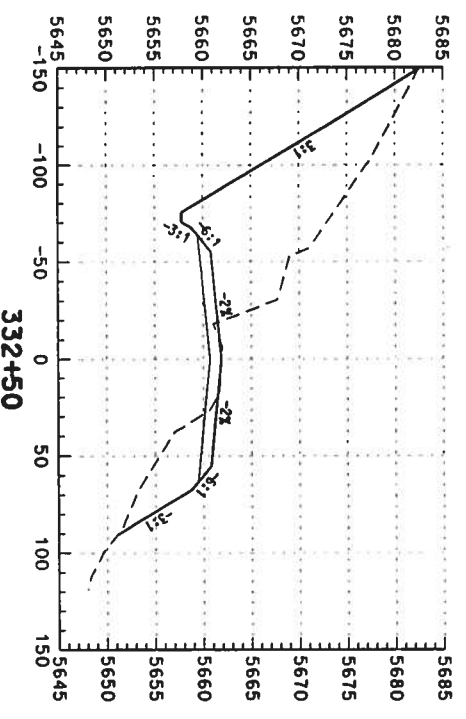
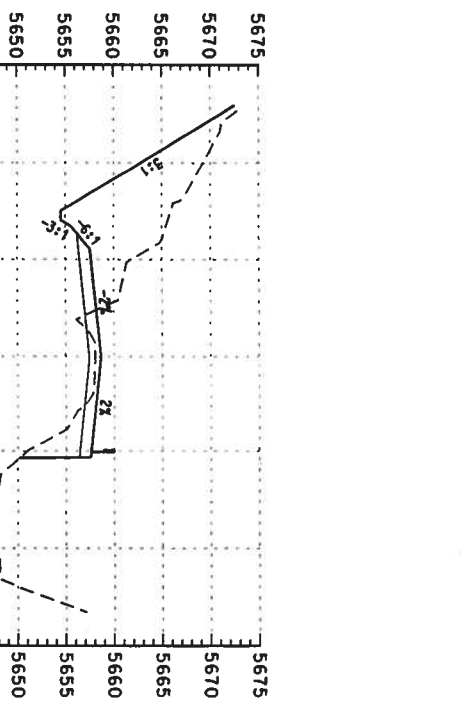
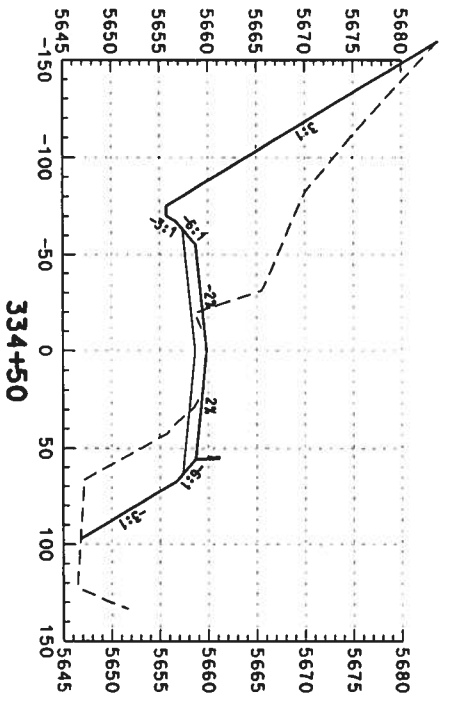
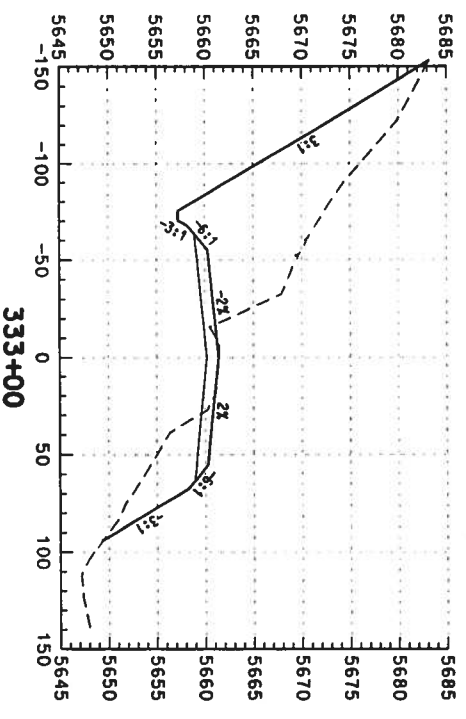

Computer File Information

Creation Date: 02/14/03 Initials: DAF
 Last Modification Date: Initials:
 Full Path: S:\trnproj\246042\HW\Des\Plans\
 Drawing File Name: rdxs-so-2d066.dgn
 Scale: Units: ENGLISH

Index of Revisions

DOT
 DEPARTMENT OF TRANSPORTATION
 359 Inverness Dr. South
 Suite K
 Englewood, CO 80112
 Phone: (303) 790-1020
 Fax: (303) 790-1037

PBSJ
 5500 Greenwood Plaza Blvd.
 Suite 150
 Greenwood Village, CO 80111
 Phone: 303/221-7275
 Fax: 303/221/7276

As Constructed

No. Revisions:	
Revised:	
Void:	

US 85 CROSS SECTIONS

Designer:	DAF
Detailer:	DAF
Sheet Subset:	Roadway
Structure Numbers:	
Subset Sheets:	
	of

Project No./Code

NH 0852-086
 13429
 Sheet Number: 365

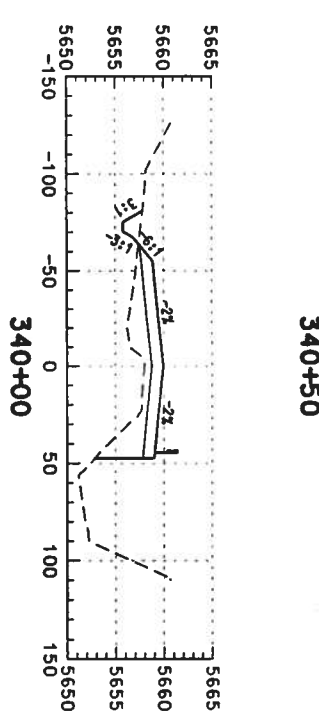
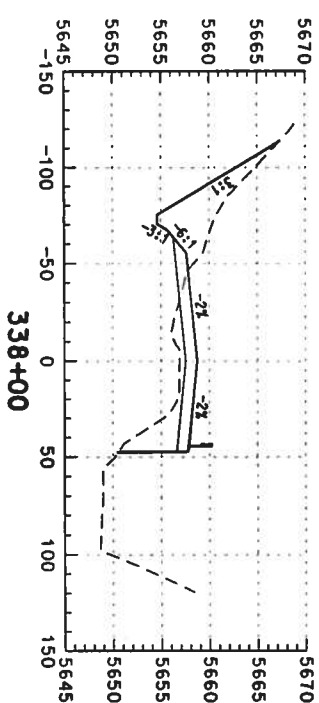
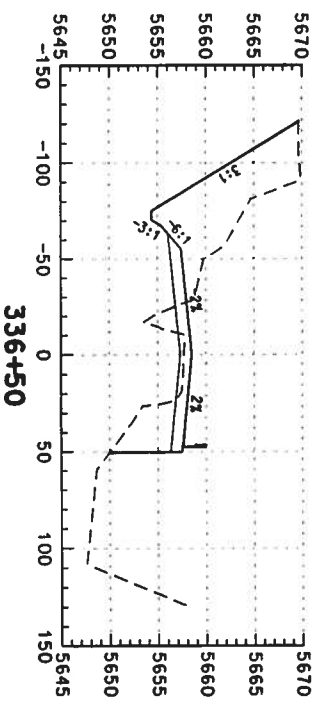
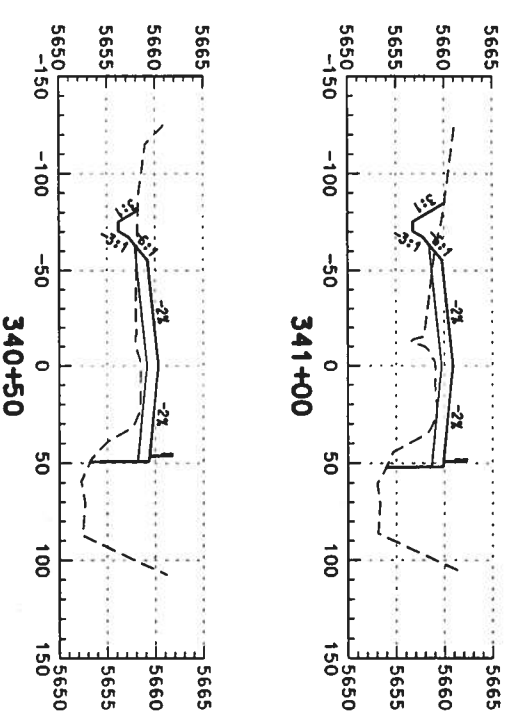
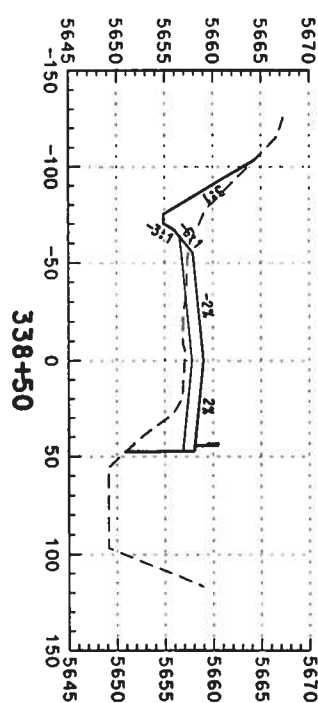
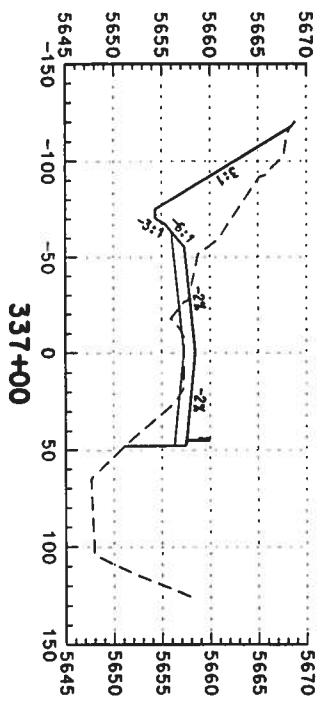
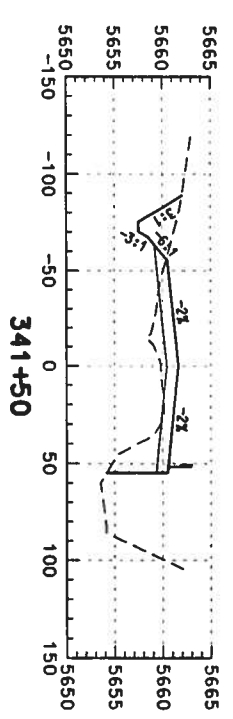
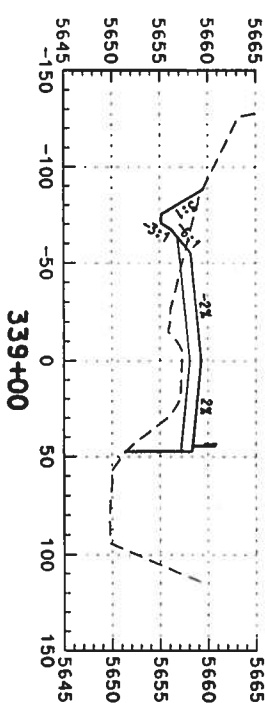
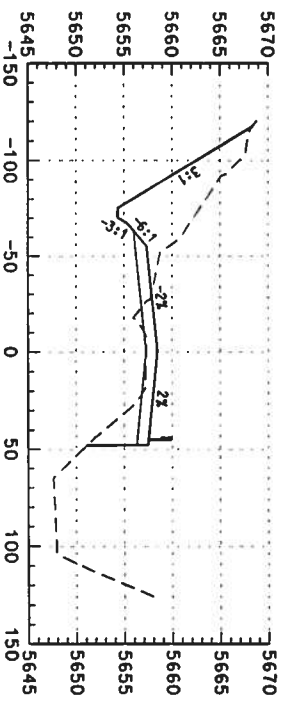
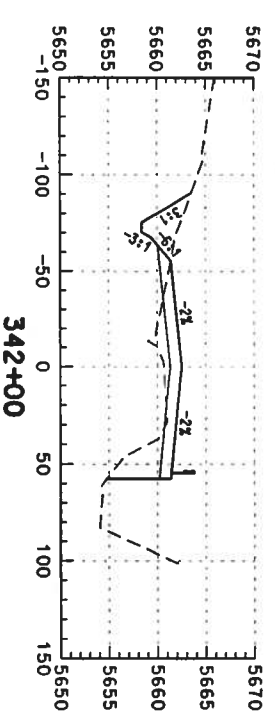
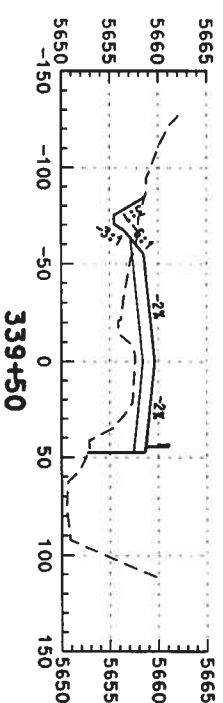
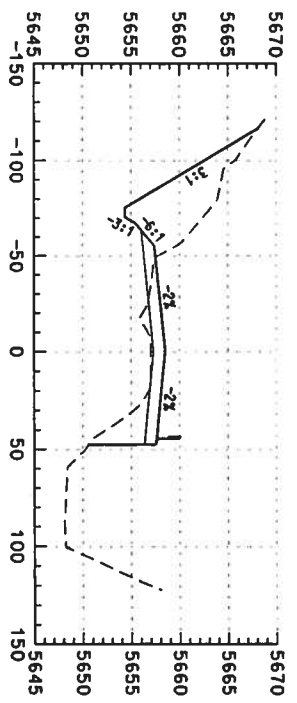

Computer File Information

Creation Date:	02/14/03	Initials:	DAF
Last Modification Date:		Initials:	
Full Path:	S:\Transport\246042\Hydes\Plans\rdxs-so-2d067.dgn		
Drawing File Name:	rdxs-so-2d067.dgn		
Scale:	Units: ENGLISH		

Index of Revisions



DOT
DEPARTMENT OF TRANSPORTATION



PBSJ

339 Inverness Dr. South
Suite K
Englewood, CO 80112
Phone: (303) 790-1020
Fax: (303) 790-1037

5500 Greenwood Plaza Blvd.
Suite 150
Greenwood Village, CO 80111
Phone: 303/221-7275
Fax: 303/221/7276

REGION 1

As Constructed

No. Revisions:	
Revised:	
Void:	

US 85 CROSS SECTIONS

Designer:	DAF	Structure	
Detailer:	DAF	Numbers	
Sheet Subset:	Roadway	Subset Sheets:	
			of

Project No./Code

NH 0852-086
13429
Sheet Number: 360

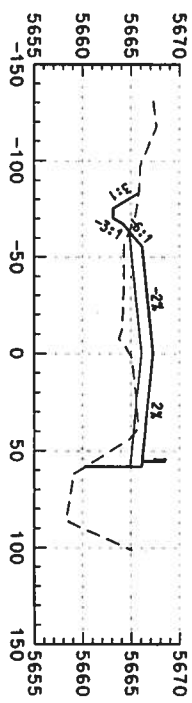

344+05

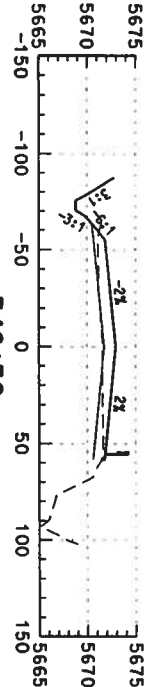

346+50

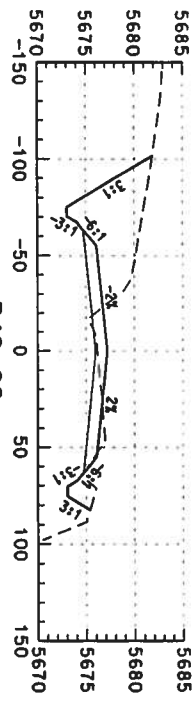

349+00

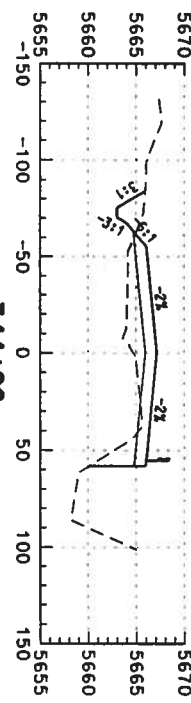

344+00

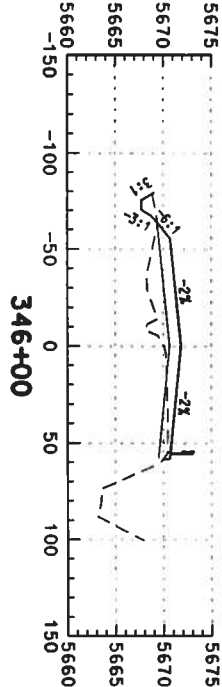

346+00

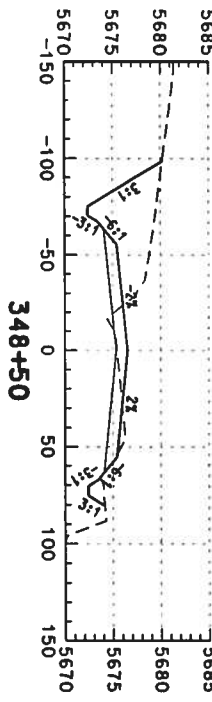

348+50

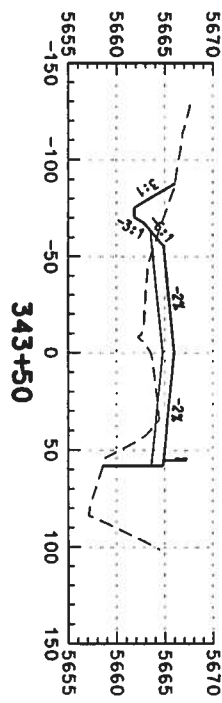

343+50

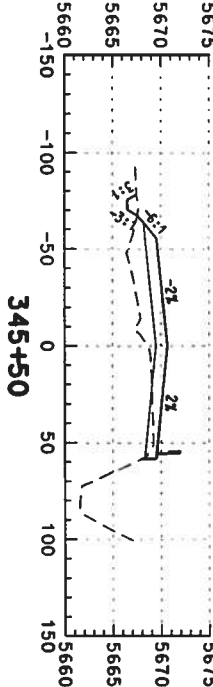

345+50

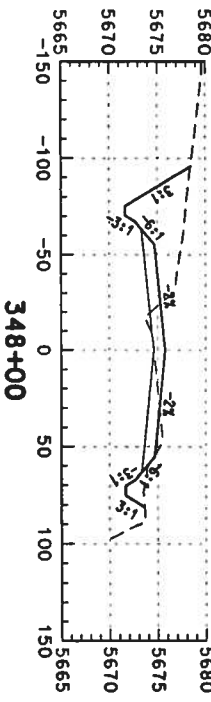

348+00

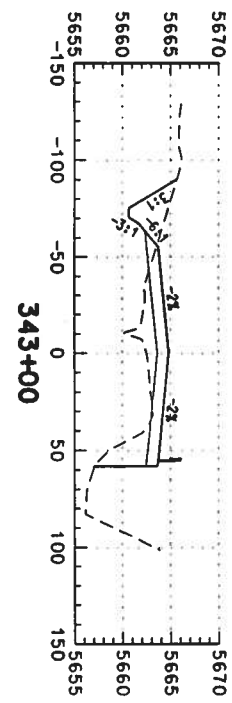

343+00

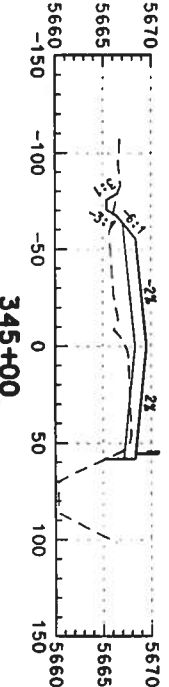

345+00

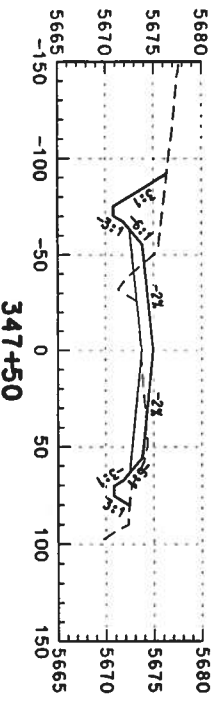

347+50

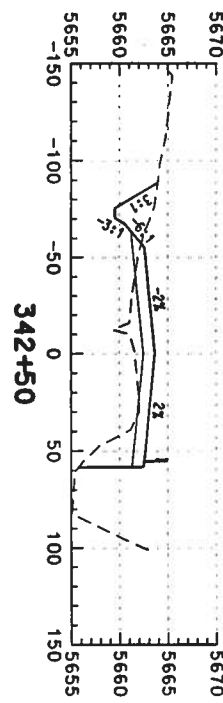

342+50

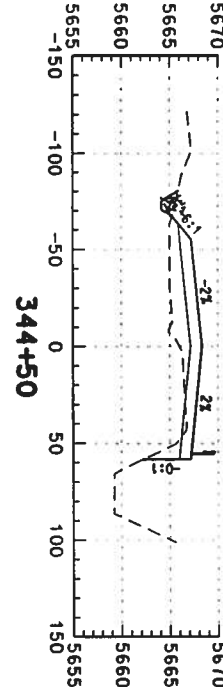

344+50

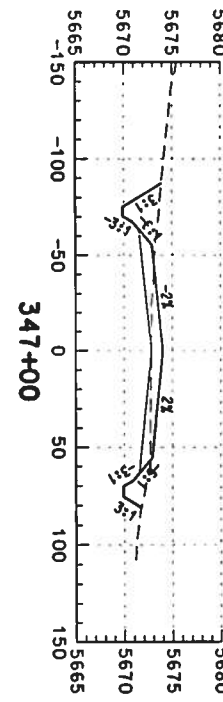

347+00

Computer File Information

Creation Date: 02/14/03 Initials: DAF
 Last Modification Date: Initials:
 Full Path: S:\Transport\246042.12\HwyDes\Plans\
 Drawing File Name: rdxs-so-2d068.dgn
 Scale: Units: ENGLISH

Index of Revisions



359 Inverness Dr. South
 Suite K
 Englewood, CO 80112
 Phone: (303) 790-1020
 Fax: (303) 790-1037

REGION 1



5500 Greenwood Plaza Blvd.
 Suite 150
 Greenwood Village, CO 80111
 Phone: 303/221-7275
 Fax: 303/221/7276

As Constructed

No. Revisions:
 Revised:
 Void:



US 85 CROSS SECTIONS

Designer: DAF
 Detailer: DAF
 Sheet Subset: Roadway
 Structure Numbers
 Subset Sheets: of

Project No./Code

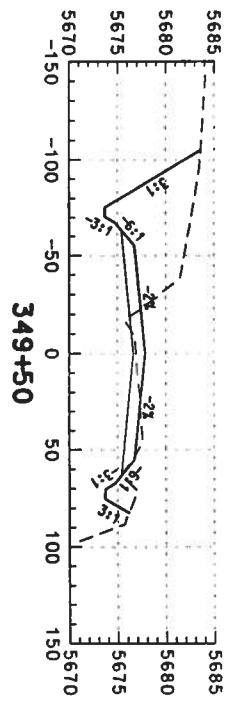
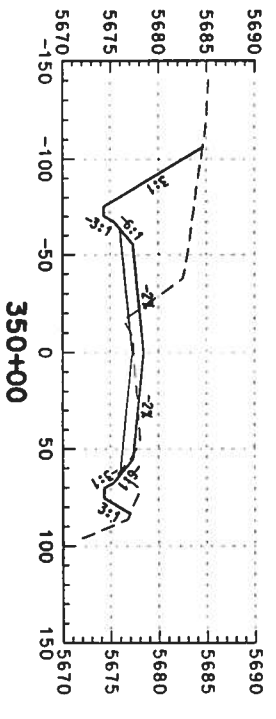
NH 0852-086
 13429
 Sheet Number: 307



Computer File Information		Index of Revisions		 <p>359 Inverness Dr. South Suite K Englewood, CO 80112 Phone: (303) 790-1020 Fax: (303) 790-1027</p>		 <p>5500 Greenwood Plaza Blvd. Suite 150 Greenwood Village, CO 80111 Phone: 303/221-7275 Fax: 303/221/7276</p>																										
Creation Date:	02/14/03	Initials:	DAF					<table border="1"> <tr><td> </td><td> </td></tr> <tr><td> </td><td> </td></tr> <tr><td> </td><td> </td></tr> <tr><td> </td><td> </td></tr> <tr><td> </td><td> </td></tr> </table>																								
Last Modification Date:		Initials:		<p>REGION 1</p>		<table border="1"> <tr> <td colspan="2">As Constructed</td> <td colspan="2" rowspan="2">US 85 CROSS SECTIONS</td> <td colspan="2" rowspan="2">Project No./Code</td> </tr> <tr> <td>No. Revisions:</td> <td> </td> <td>Designer:</td> <td>DAF</td> <td>Structure</td> <td> </td> </tr> <tr> <td>Revised:</td> <td> </td> <td>Detailer:</td> <td>DAF</td> <td>Numbers</td> <td> </td> <td rowspan="2"> Sheet Number: 368 </td> </tr> <tr> <td>Void:</td> <td> </td> <td>Sheet Subset:</td> <td>Roadway</td> <td>Subset Sheets:</td> <td> </td> </tr> </table>		As Constructed		US 85 CROSS SECTIONS		Project No./Code		No. Revisions:		Designer:	DAF	Structure		Revised:		Detailer:	DAF	Numbers		Sheet Number: 368	Void:		Sheet Subset:	Roadway	Subset Sheets:	
As Constructed		US 85 CROSS SECTIONS						Project No./Code																								
No. Revisions:				Designer:	DAF	Structure																										
Revised:		Detailer:	DAF	Numbers		Sheet Number: 368																										
Void:		Sheet Subset:	Roadway	Subset Sheets:																												
Full Path:	S:\Transporto\246042.12\HwyDes\Plans\																															
Drawing File Name:	rdxs-so-24069.dgn																															
Scale:	Units: ENGLISH																															

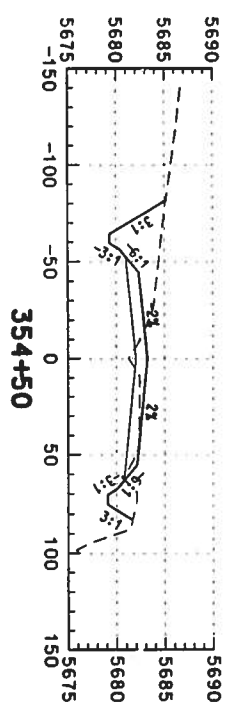
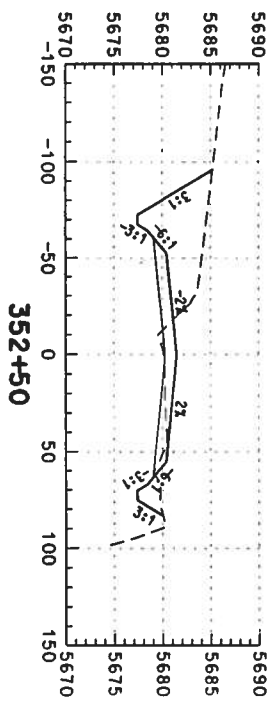
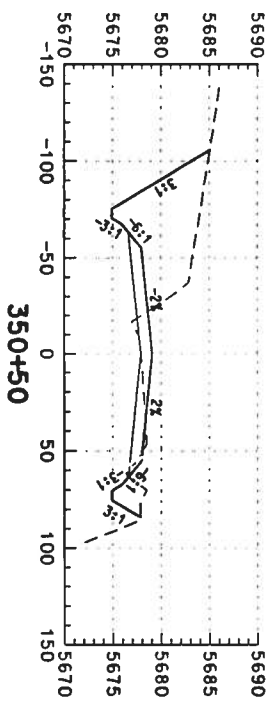
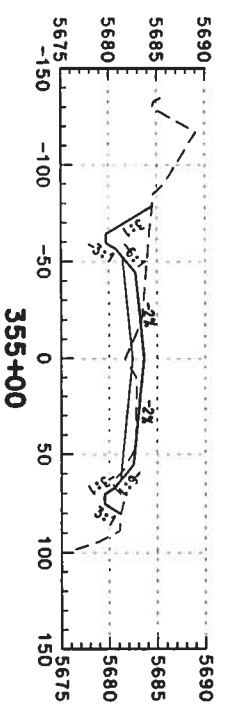
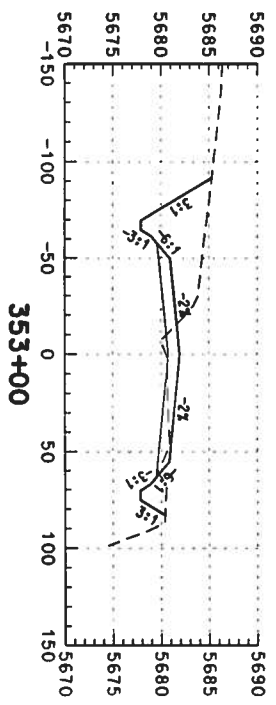
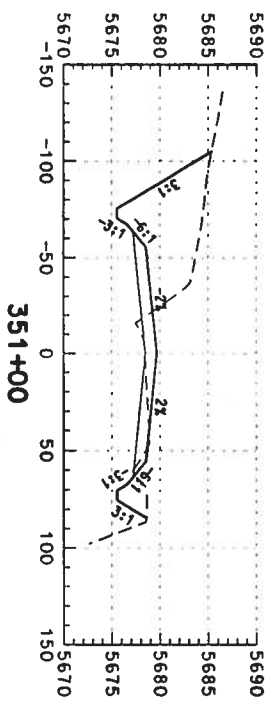
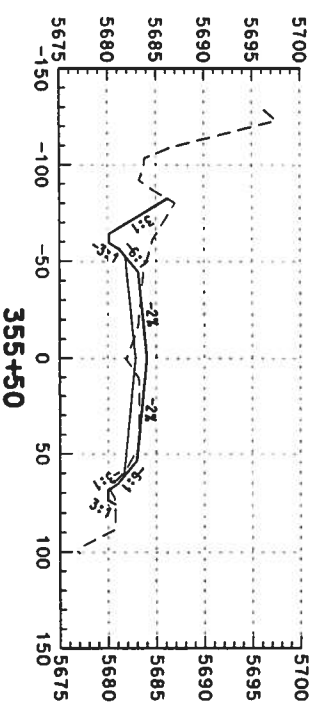
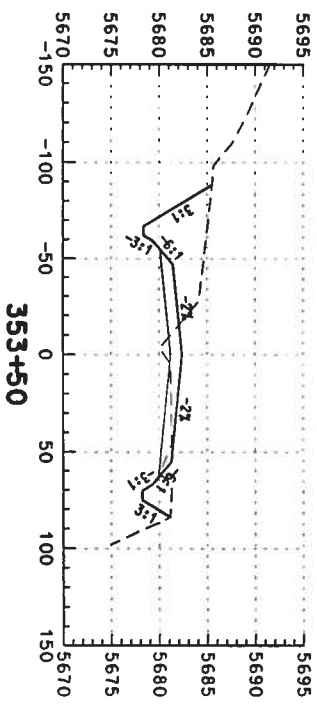
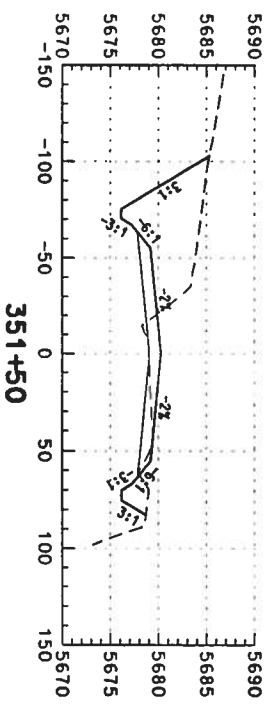
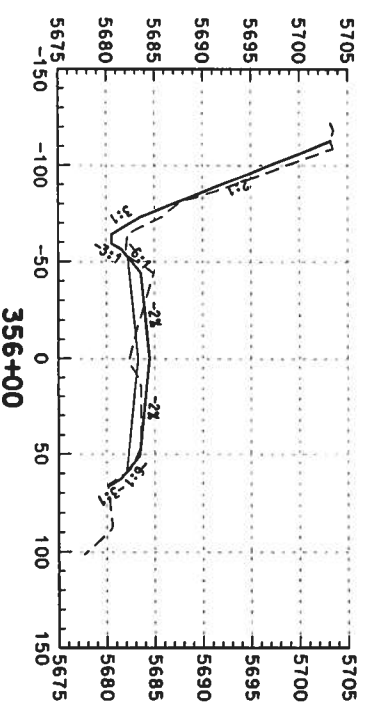
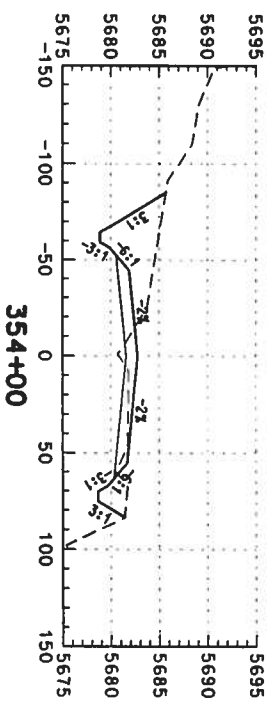
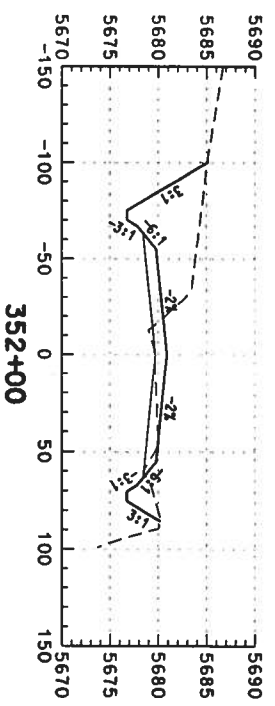

Computer File Information

Creation Date: 02/14/03 initials: DAF
 Last Modification Date: initials:
 Full Path: S:\Tranpro\246042.12\HwyDes\Plans\rdxs-so-20070.dgn
 Drawing File Name: Units: ENGLISH
 Scale:

Index of Revisions



359 Inverness Dr. South
 Suite K
 Englewood, CO 80112
 Phone: (303) 790-1020
 Fax: (303) 790-1037

REGION 1



5500 Greenwood Plaza Blvd.
 Suite 150
 Greenwood Village, CO 80111
 Phone: 303/221-7275
 Fax: 303/221/7276

As Constructed

No. Revisions:
 Revised:
 Void:

US 85 CROSS SECTIONS

Designer: DAF
 Checker: DAF
 Sheet Subset: Roadway
 Structure Numbers
 Subset Sheets: of

Project No./Code

NH 0852-086
 13429
 Sheet Number: 369

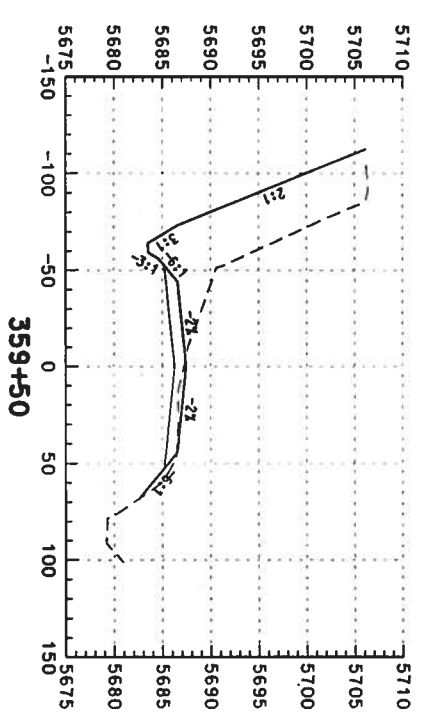
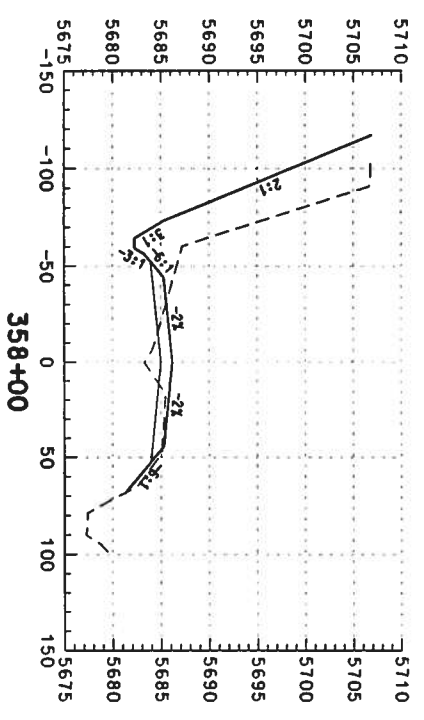
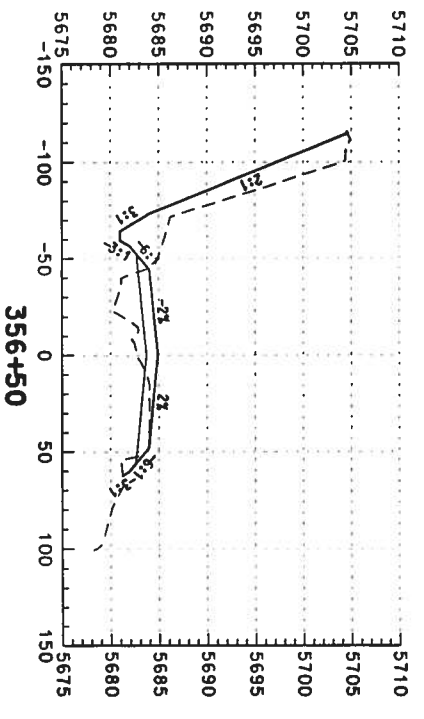
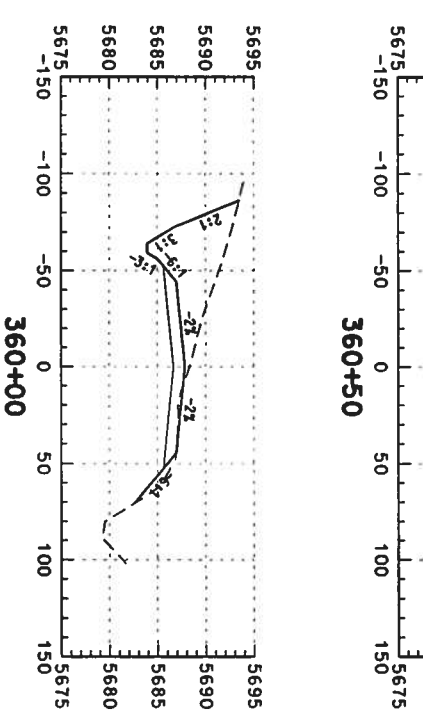
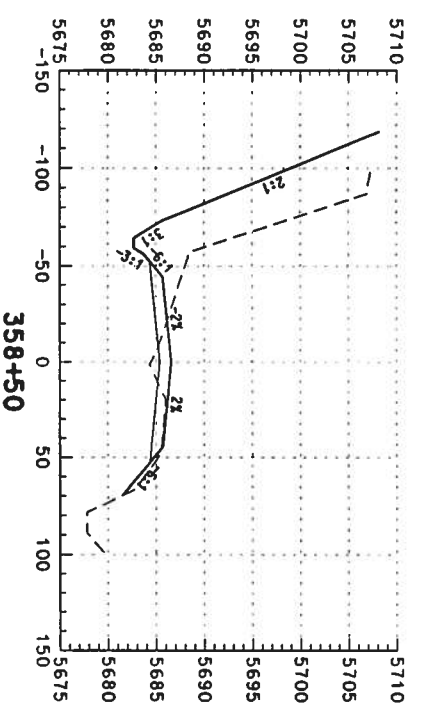
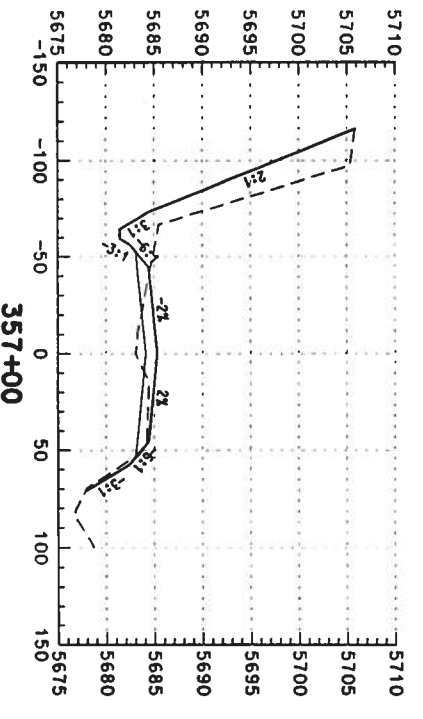
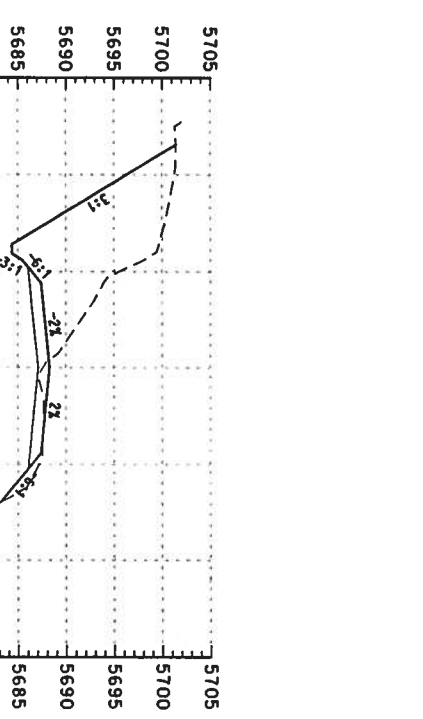
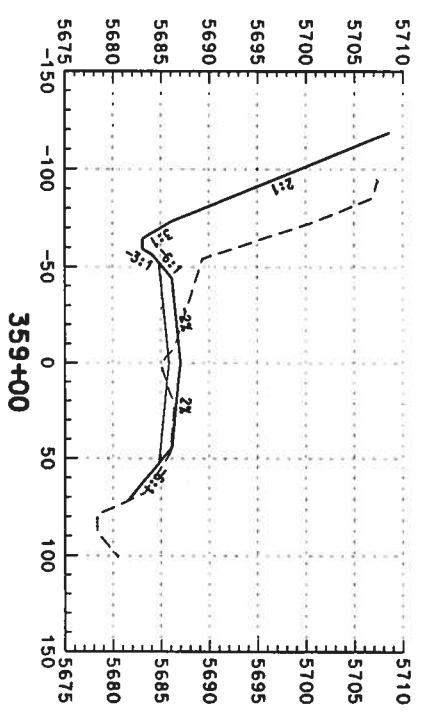
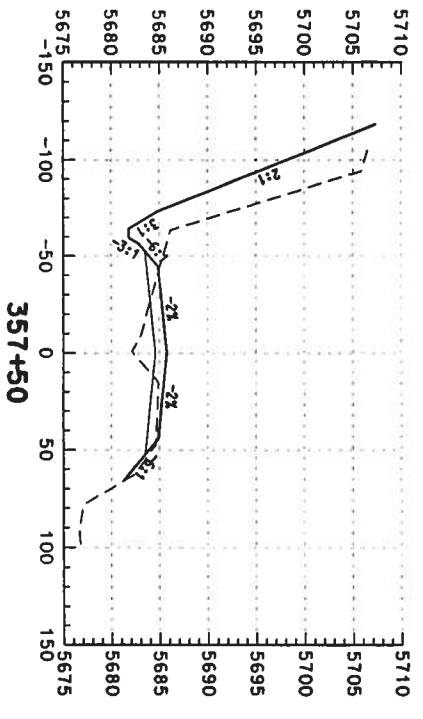

Computer File Information

Creation Date: 02/14/03 Initials: DAF
 Last Modification Date: Initials:
 Full Path: S:\Transport\246042\HwyDes\Plans\
 Drawing File Name: rdxs-so-2d071.dgn
 Scale: Units: ENGLISH

Index of Revisions



REGION I

359 Inverness Dr. South
 Suite K
 Englewood, CO 80112
 Phone: (303) 790-1020
 Fax: (303) 790-1037



5500 Greenwood Plaza Blvd.
 Suite 150
 Greenwood Village, CO 80111
 Phone: 303/221-7275
 Fax: 303/221-7276

As Constructed

No. Revisions:
 Revised:
 Void:

US 85 CROSS SECTIONS

Designer: DAF
 Checker: DAF
 Sheet Subset: Roadway

Project No./Code: NH 0852-086
 Sheet Number: 13429
 of 370

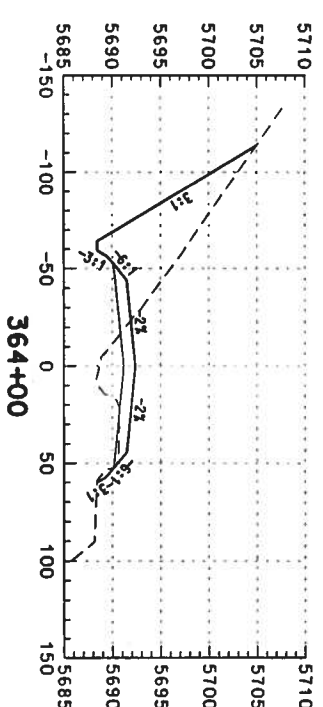
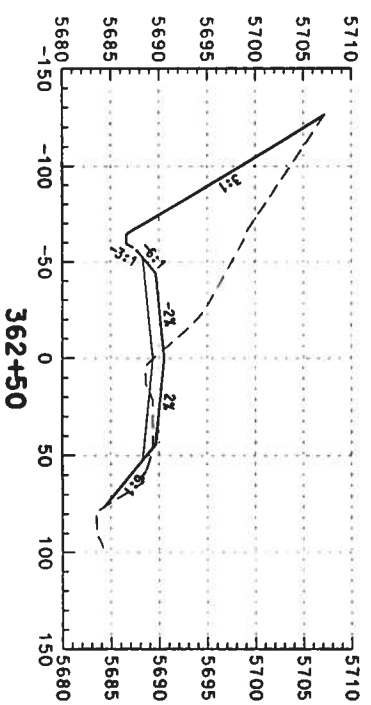
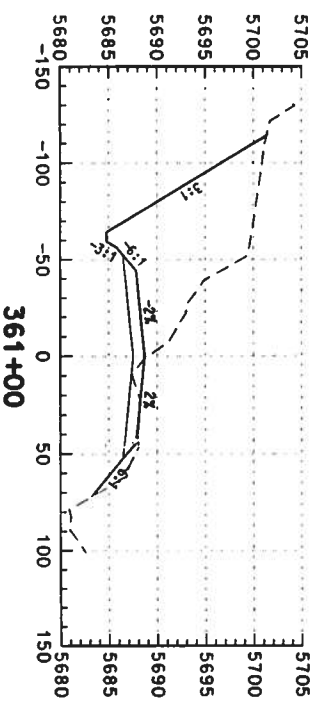
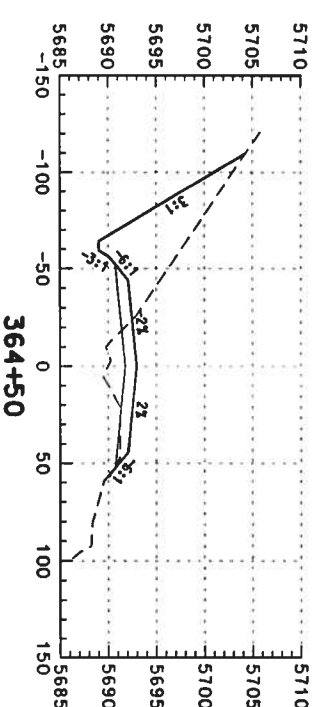
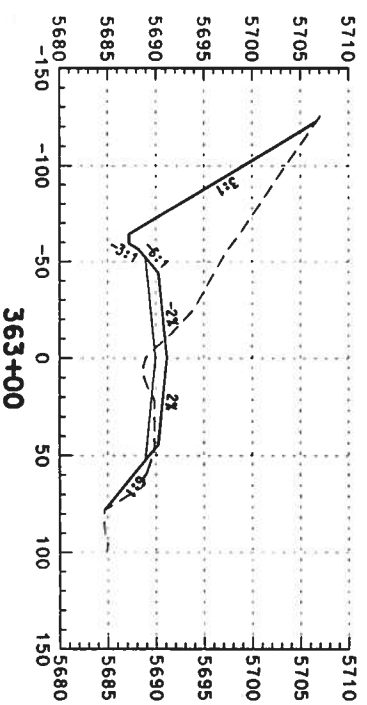
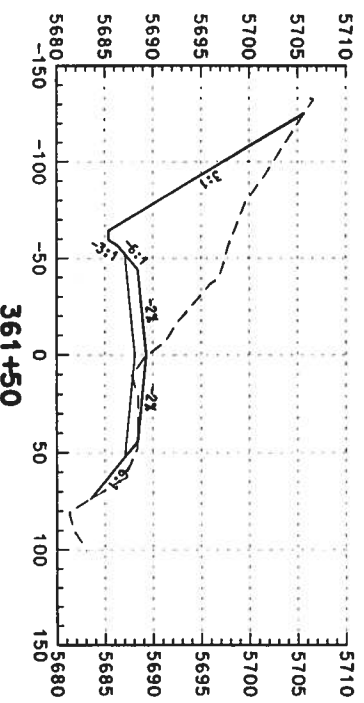
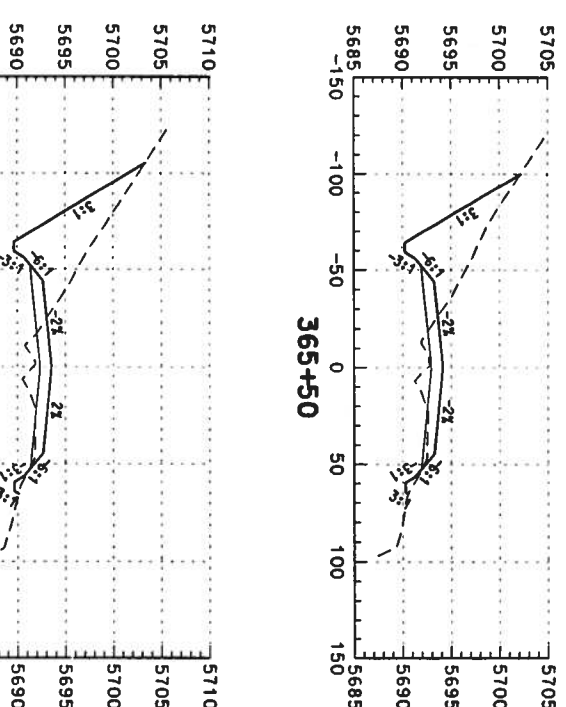
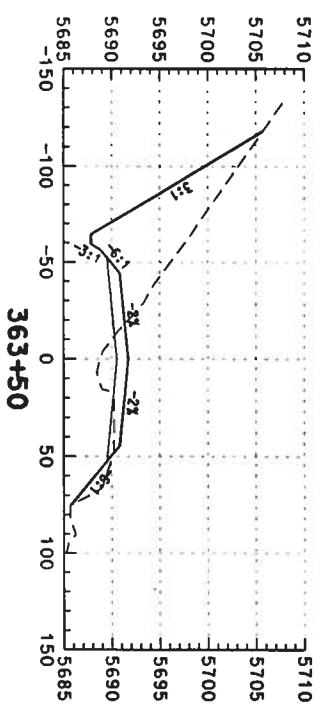
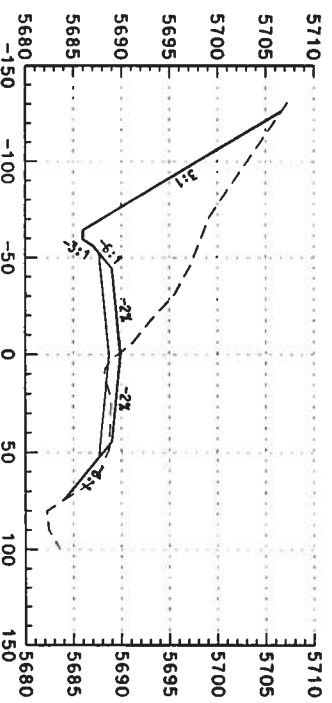

Computer File Information

Creation Date: 02/14/03 Initials: DAF
 Last Modification Date: Initials:
 Full Path: S:\Transport\246042\Hydes\Plans\
 Drawing File Name: rdxs-so-2d072.dgn
 Scale: Units: ENGLISH

Index of Revisions

DOT
 DIVISION OF TRANSPORTATION
 REGION 1
 359 Inverness Dr. South
 Suite K
 Englewood, CO 80112
 Phone: (303) 790-1020
 Fax: (303) 790-1037

PBS&J
 5500 Greenwood Plaza Blvd.
 Suite 150
 Greenwood Village, CO 80111
 Phone: 303/221-7275
 Fax: 303/221/7276

As Constructed

No. Revisions:
 Revised:
 Void:

US 85 CROSS SECTIONS

Designer: DAF
 Detailer: DAF
 Sheet Subset: Roadway
 Structure Numbers
 Subset Sheets: of

Project No./Code

NH 0852-086
 13429
 Sheet Number: 371

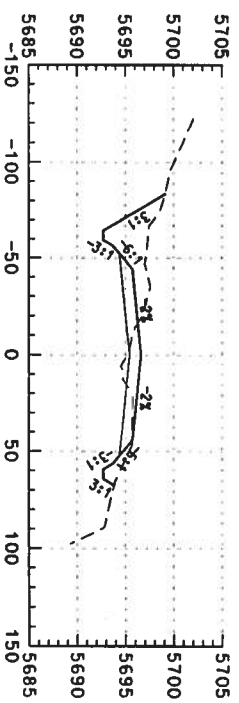

367+50

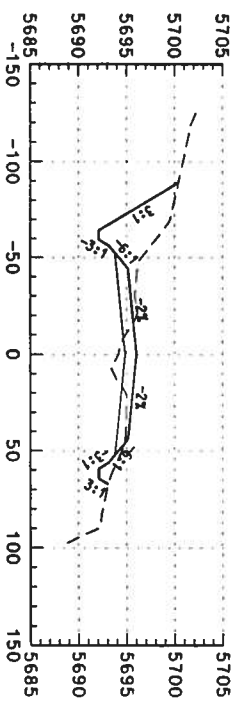

367+00

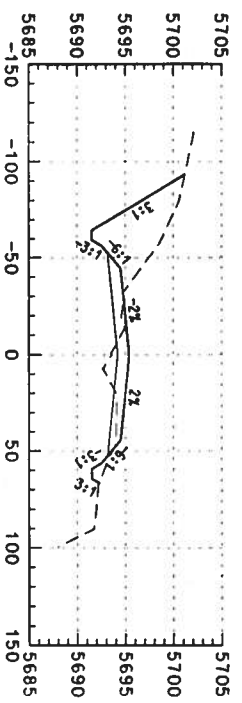

366+50

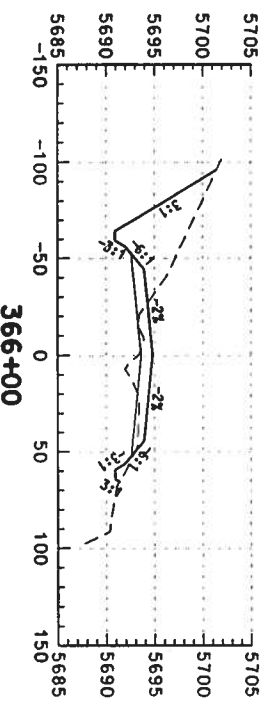

366+00

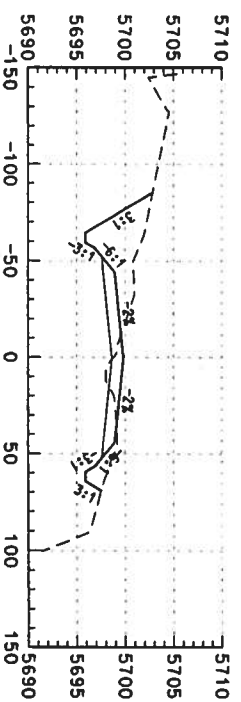

369+50

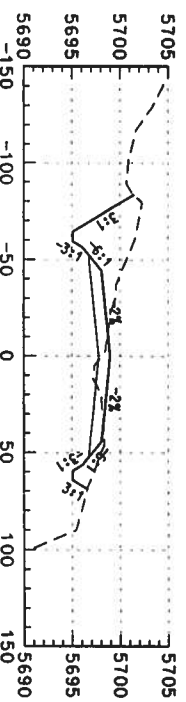

369+00

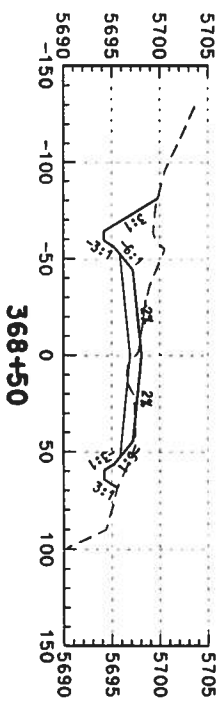

368+50

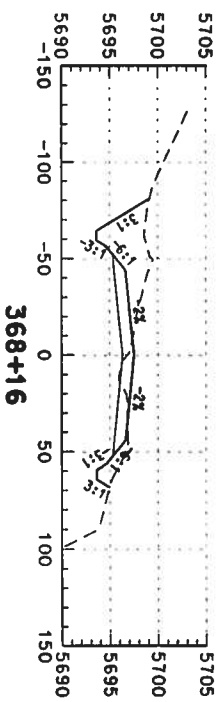

368+16

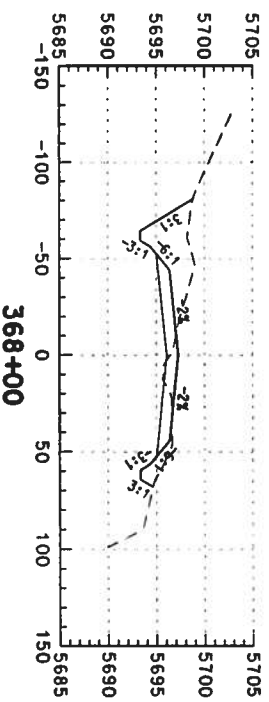

368+00

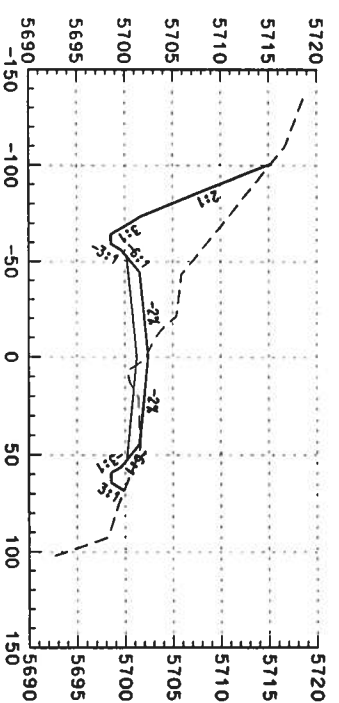

371+00

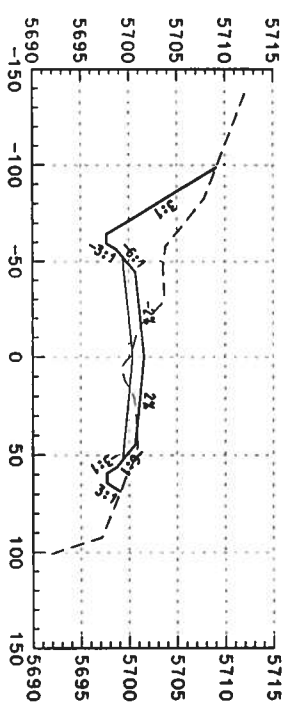

370+50

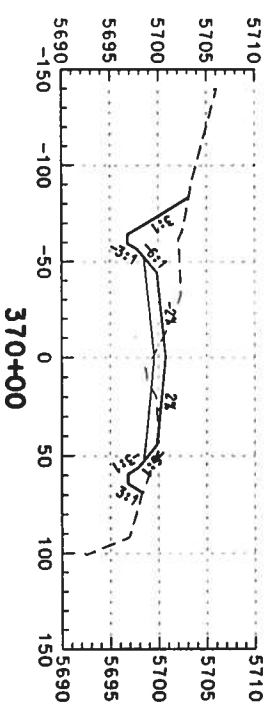

370+00

Computer File Information
 Creation Date: 02/14/03 Initials: DAF
 Last Modification Date: Initials:
 Full Path: S:\Transport\246042.12\HwyDes\Plans\
 Drawing File Name: rdxs-so-2d073.dgn
 Scale: Units: ENGLISH

Index of Revisions

DOT
 DEPARTMENT OF TRANSPORTATION
 REGION 1
 359 Inverness Dr. South
 Suite K
 Englewood, CO 80112
 Phone: (303) 790-1020
 Fax: (303) 790-1037

PBS&J
 5500 Greenwood Plaza Blvd.
 Suite 150
 Greenwood Village, CO 80111
 Phone: 303/221-7275
 Fax: 303/221/7276

As Constructed
 No. Revisions:
 Revised:
 Void:

US 85 CROSS SECTIONS
 Designer: DAF Structure Numbers:
 Detailer: DAF
 Sheet Subset: Roadway Subset Sheets: of

Project No./Code
 NH 0852-086
 Sheet Number: 13429
 312

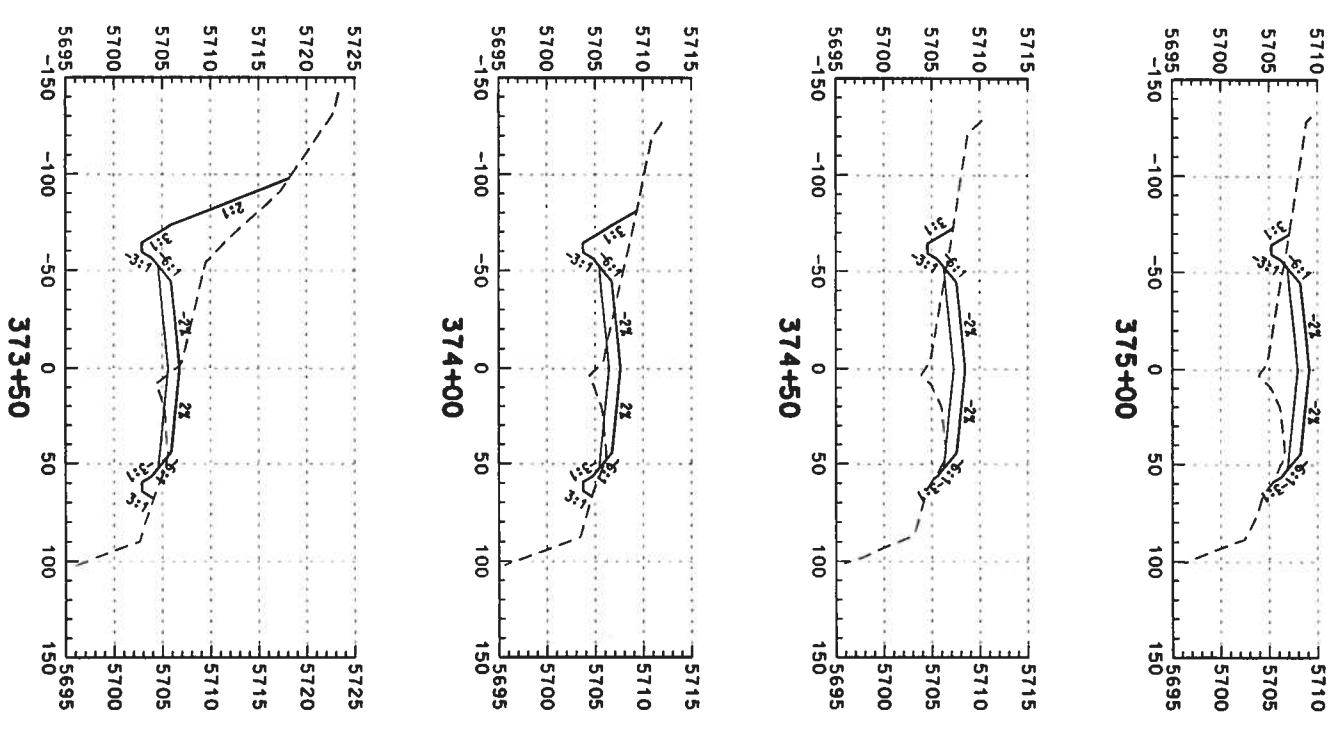
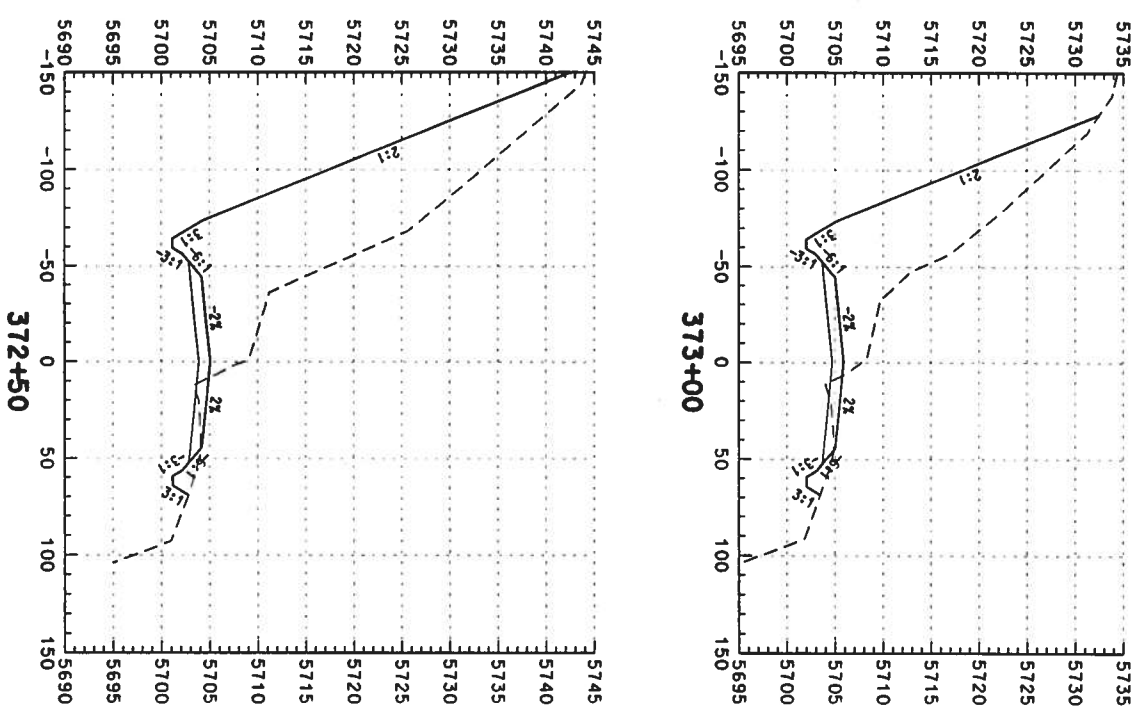
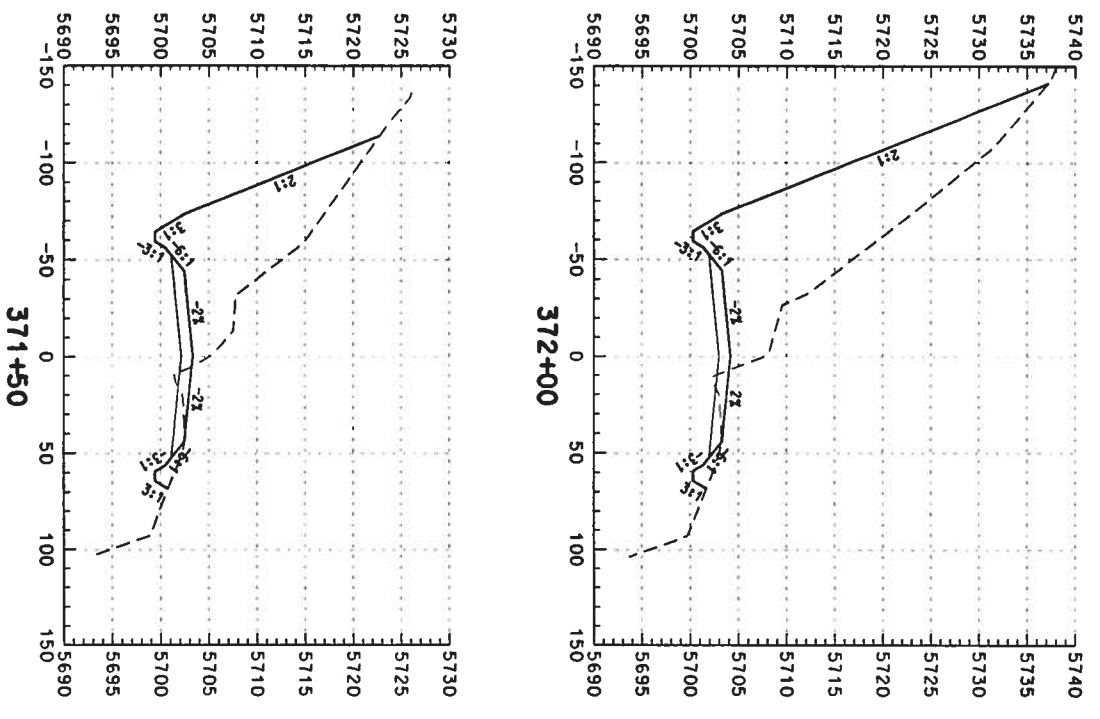

Computer File Information

Creation Date: 02/14/03 Initials: DAF
 Last Modification Date: Initials:
 Full Path: S:\Transport\246042.12\HWDes\Plans\
 Drawing File Name: rdxs-so-2d074.dgn
 Scale: Units: ENGLISH

Index of Revisions



REGION 1
 359 Inverness Dr. South
 Suite K
 Englewood, CO 80112
 Phone: (303) 790-1020
 Fax: (303) 790-1037



5500 Greenwood Plaza Blvd.
 Suite 150
 Greenwood Village, CO 80111
 Phone: 303/221-7275
 Fax: 303/221-7276

As Constructed

No. Revisions:
 Revised:
 Void:

US 85 CROSS SECTIONS

Designer: DAF
 Detailer: DAF
 Sheet Subset: Roadway
 Structure Numbers
 Subset Sheets: of

Project No./Code

NH 0852-086
 13429
 Sheet Number: 373

Computer File Information	
Creation Date:	02/14/03
Last Modification Date:	
Full Path:	S:\Tranpro\246042\HwyDes\Plans\rdxs-so-2d075.dgn
Drawing File Name:	
Scale:	Units: ENGLISH

Index of Revisions	



REGION 1

399 Inverness Dr. South
Suite K
Englewood, CO 80112
Phone: (303) 790-1020
Fax: (303) 790-1037



5500 Greenwood Plaza Blvd
Suite 150
Greenwood Village, CO 80111
Phone: 303/221-7275
Fax: 303/221-7276

As Constructed	
No. Revisions:	
Revised:	
Void:	

US 85 CROSS SECTIONS	
Designer:	DAF
Detailer:	DAF
Sheet Subset:	Roadway
Structure Numbers:	
Subset Sheets:	

Project No./Code	
NH 0852-086	
13429	
Sheet Number:	374

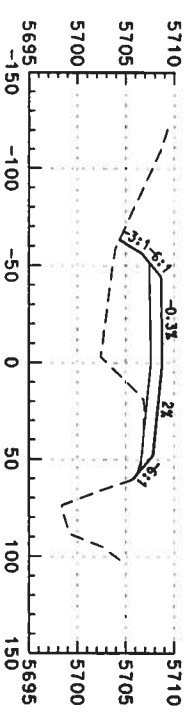

383+00

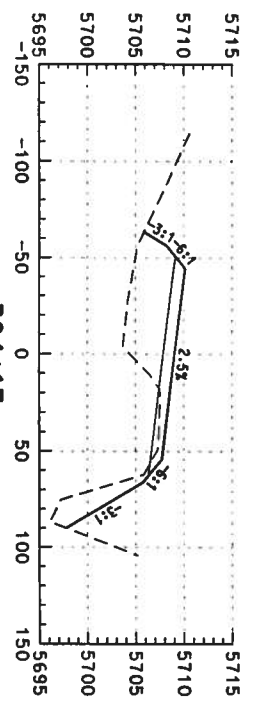

384+13

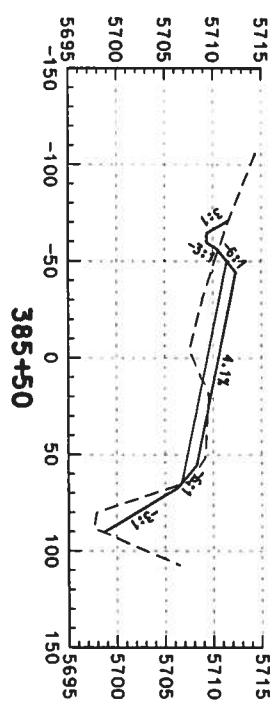

385+50

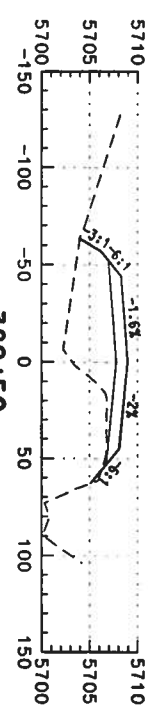

382+50

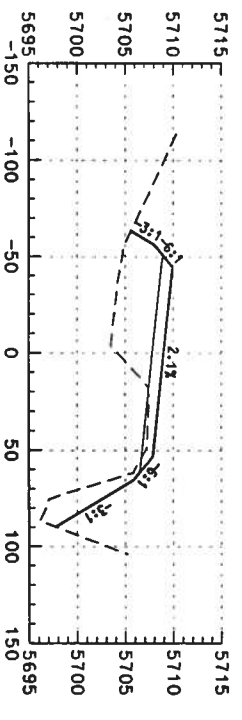

384+00

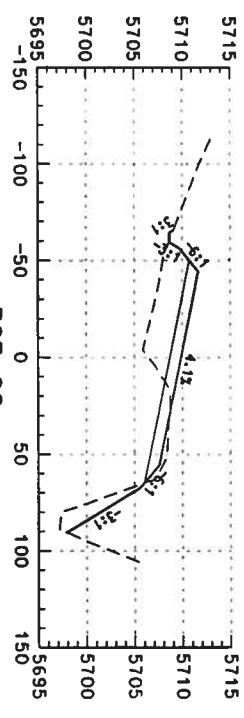

385+00

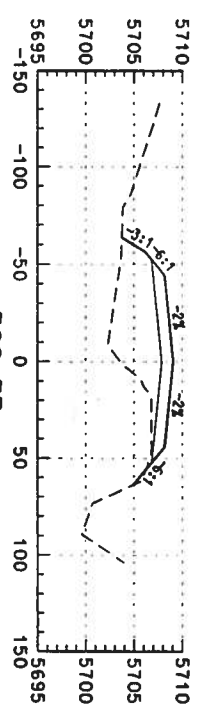

382+33

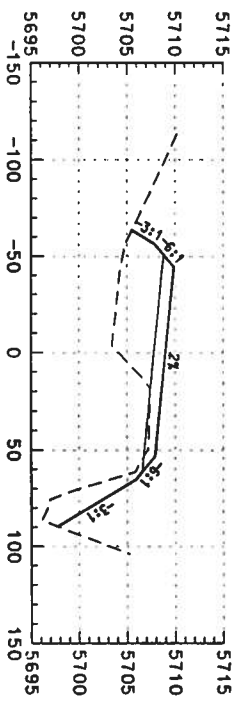

383+94

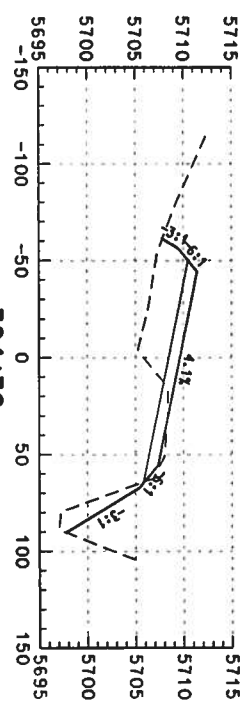

384+79

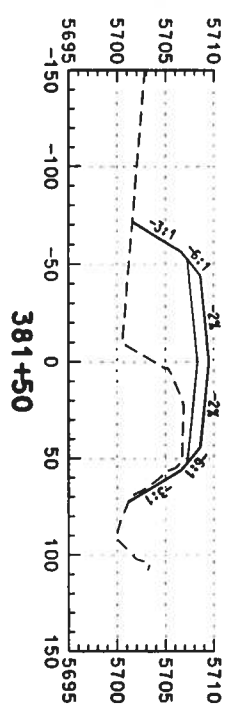

381+50

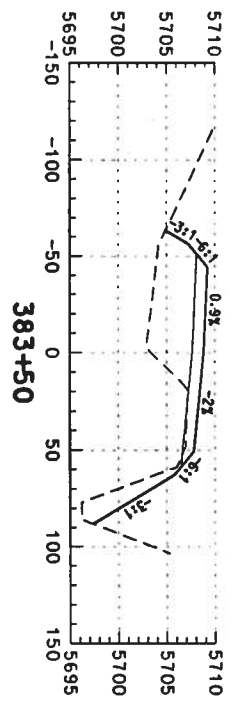

383+50

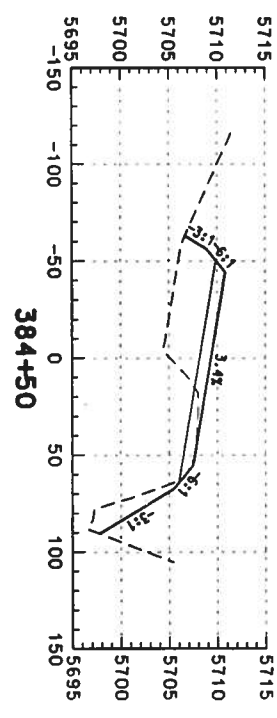

384+50

Computer File Information

Creation Date: 02/14/03 Initials: DAF
 Last Modification Date: Initials:
 Full Path: S:\Transport\246042\HwyDes\Plans\
 Drawing File Name: r dxs-so-2d076.dgn
 Scale: Units: ENGLISH

Index of Revisions

DOT
 DEPARTMENT OF TRANSPORTATION
 REGION 1

359 Inverness Dr. South
 Suite K
 Englewood, CO 80112
 Phone: (303) 790-1020
 FAX: (303) 790-1037

PBSJ
 5500 Greenwood Plaza Blvd.
 Suite 150
 Greenwood Village, CO 80111
 Phone: 303/721-7275
 Fax: 303/721/7276

As Constructed

No. Revisions:	
Revised:	
Void:	

US 85 CROSS SECTIONS

Designer:	DAF	Structure	
Detailer:	DAF	Numbers	
Sheet Subset:	Roadway	Subset Sheets:	

Project No./Code

NH 0852-086
 13429
 Sheet Number: 375 of

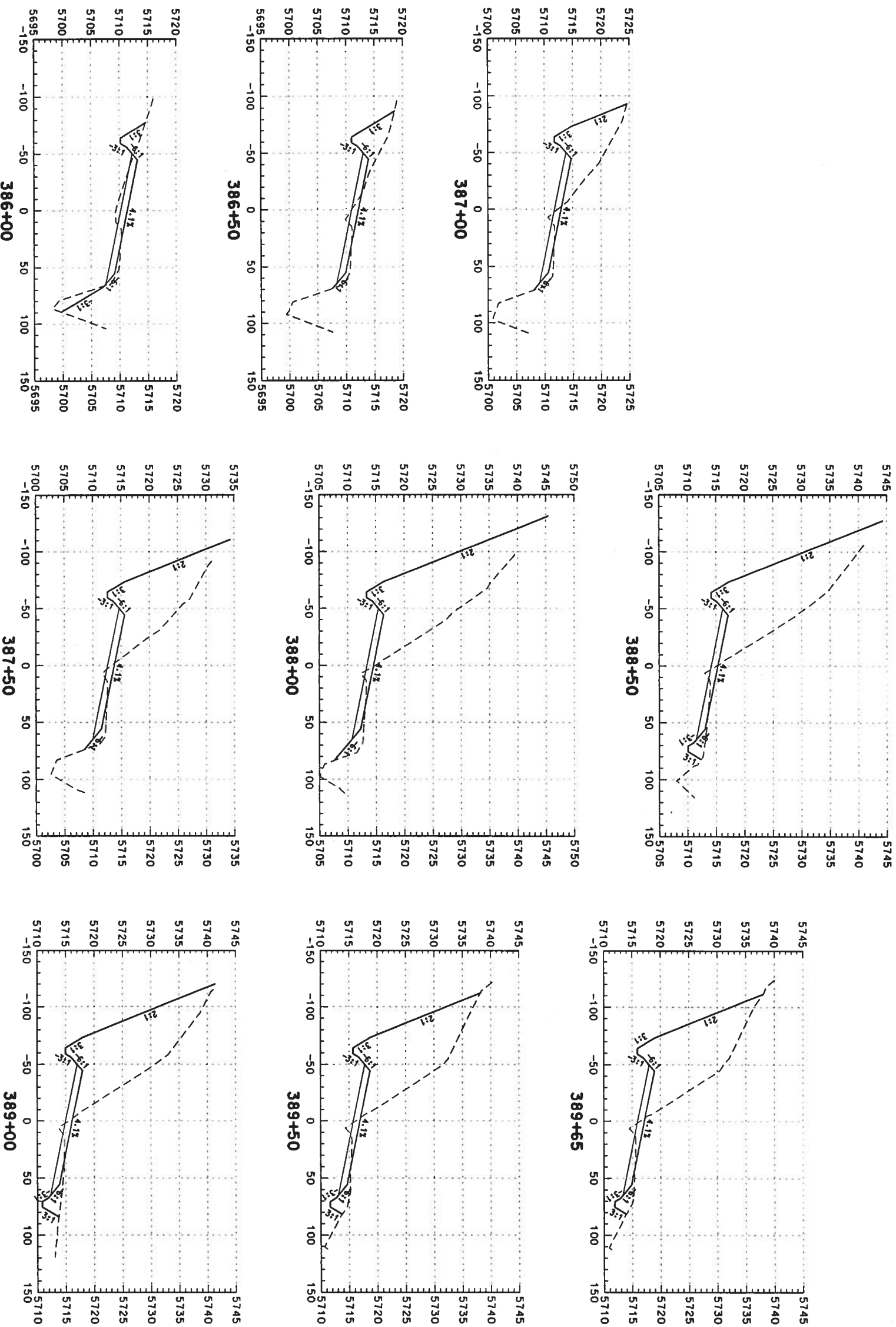

Computer File Information

Creation Date: 02/14/03 Initials: DAF
 Last Modification Date: Initials:
 Full Path: S:\Tranpro\246042\2\HwyDes\Plans\
 Drawing File Name: rdxs-so-2d077.dgn
 Scale: Units: ENGLISH

Index of Revisions



REGION 1
 359 Inverness Dr. South
 Suite K
 Englewood, CO 80112
 Phone: (303) 790-1020
 Fax: (303) 790-1037

PBSJ
 5500 Greenwood Plaza Blvd.
 Suite 150
 Greenwood Village, CO 80111
 Phone: 303/221-7275
 Fax: 303/221/7276

As Constructed

No. Revisions:	
Revised:	
Void:	

US 85 CROSS SECTIONS

Designer:	DAF	Structure	
Detailer:	DAF	Numbers	
Sheet Subset:	Roadway	Subset Sheets:	

Project No./Code

NH 0852-086
 13429
 Sheet Number: 376

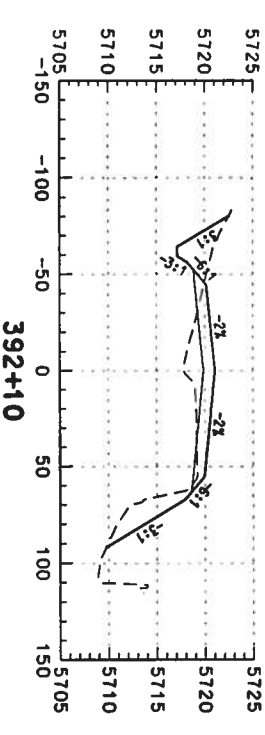
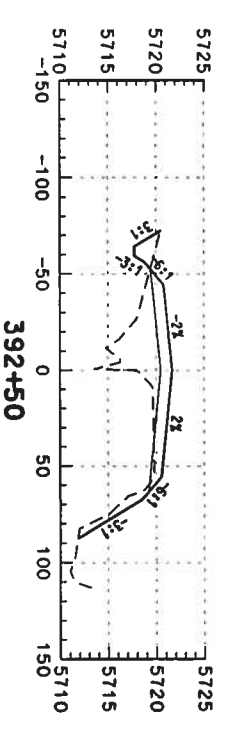
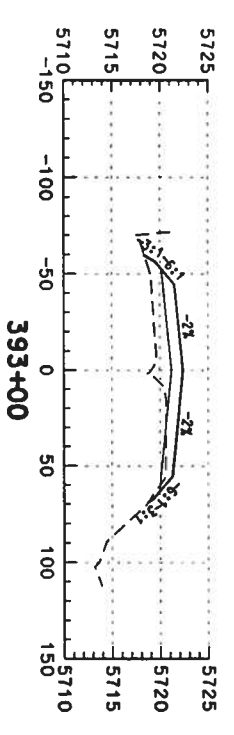
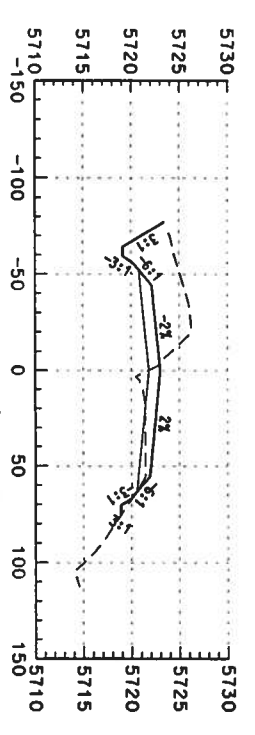
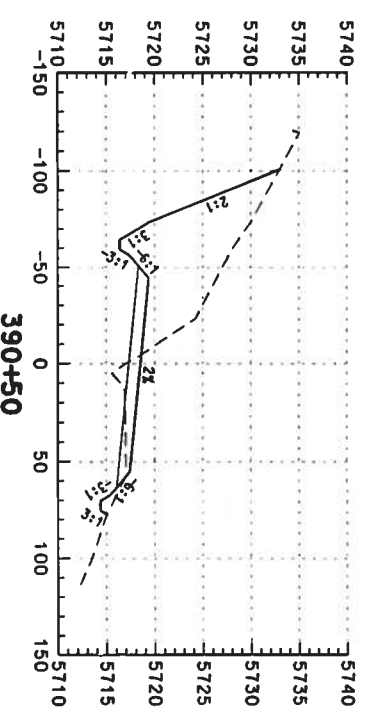
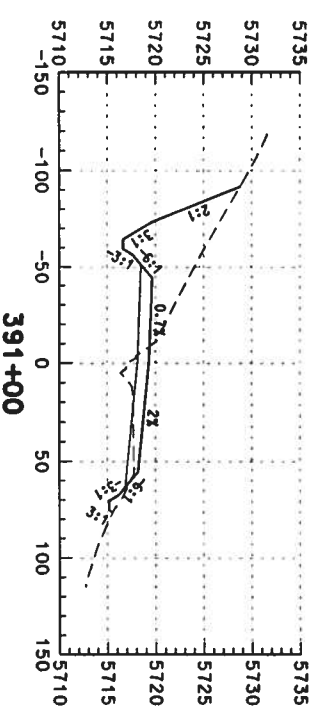
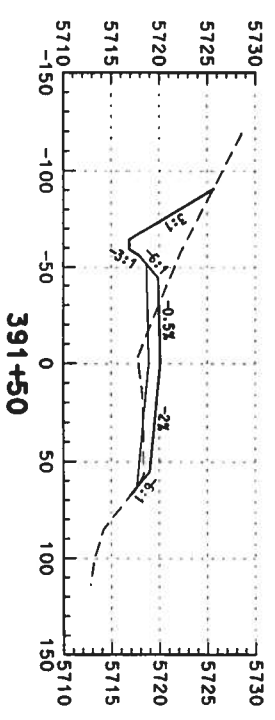
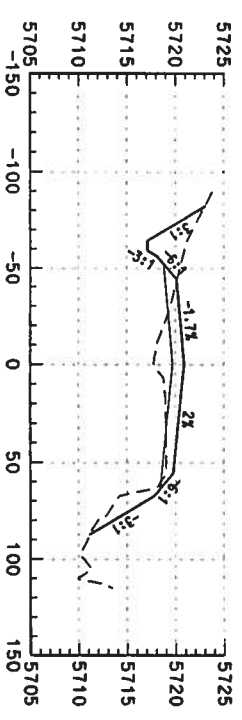
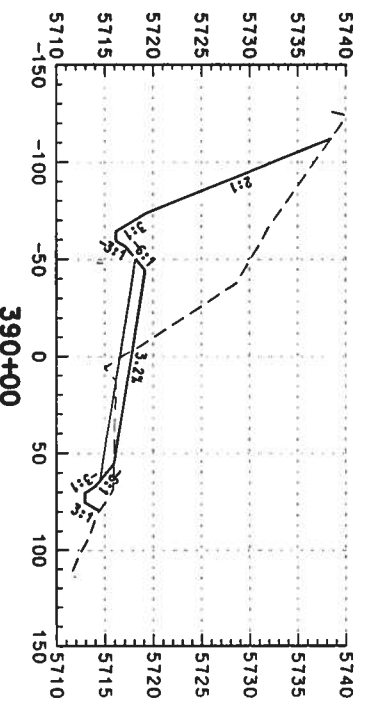
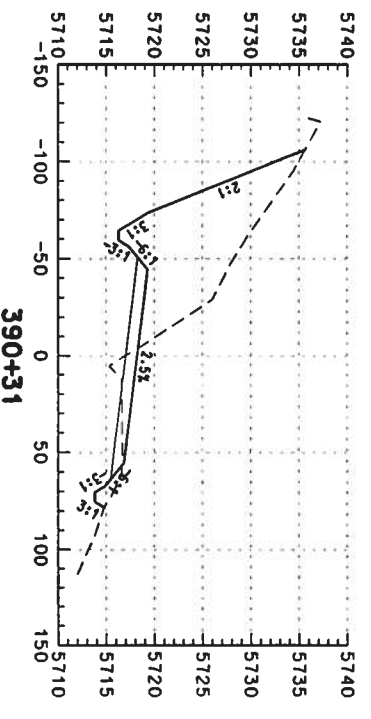
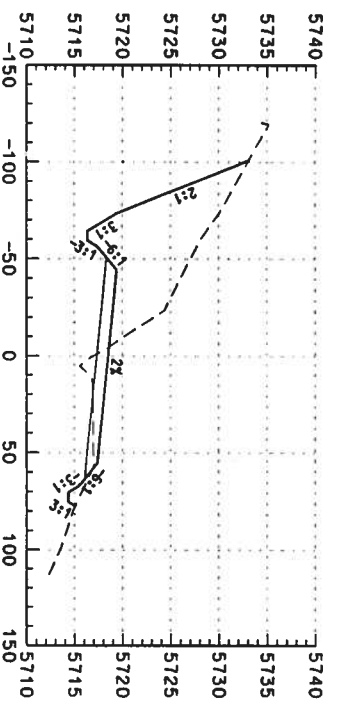

Computer File Information
 Creation Date: 02/14/03 Initials: DAF
 Last Modification Date: Initials:
 Full Path: S:\Tranproj\246042\HwyDes\Plans\
 Drawing File Name: rdxs-so-2d078.dgn
 Scale: Units: ENGLISH

Index of Revisions

DOT
 DEPARTMENT OF TRANSPORTATION
 REGION 1
 359 Inverness Dr. South
 Suite K
 Englewood, CO 80112
 Phone: (303) 790-1020
 FAX: (303) 790-1037

PBSJ
 5500 Greenwood Plaza Blvd.
 Suite 150
 Greenwood Village, CO 80111
 Phone: 303/221-7275
 Fax: 303/221-7276

As Constructed
 No. Revisions:
 Revised:
 Void:

US 85 CROSS SECTIONS
 Designer: DAF
 Detailer: DAF
 Sheet Subset: Roadway
 Structure Numbers
 Subset Sheets: of

Project No./Code
 NH 0852-086
 Sheet Number: 37-4

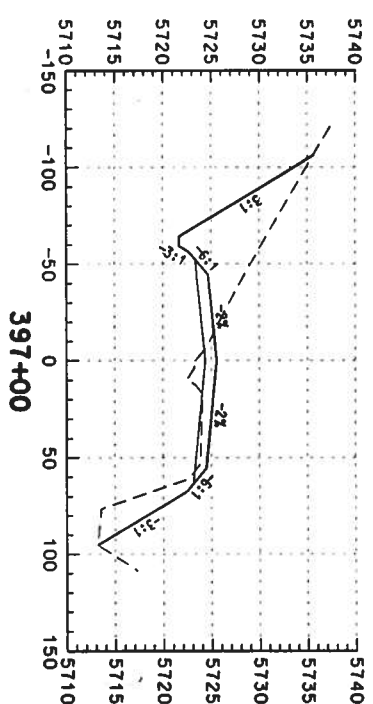
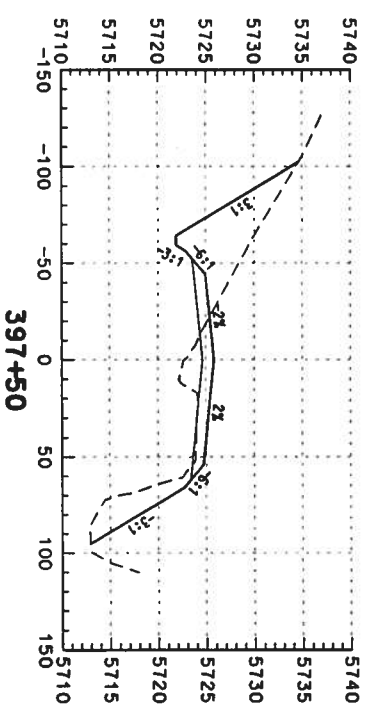
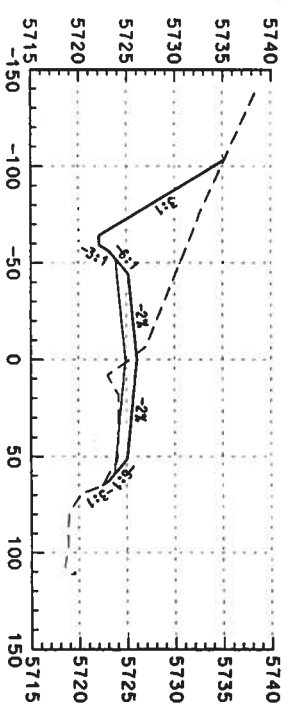
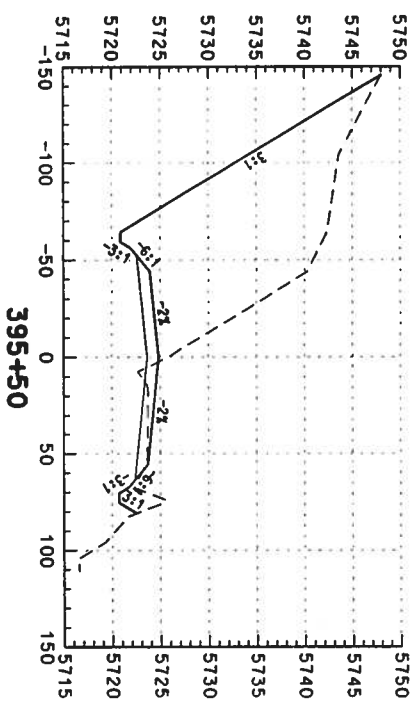
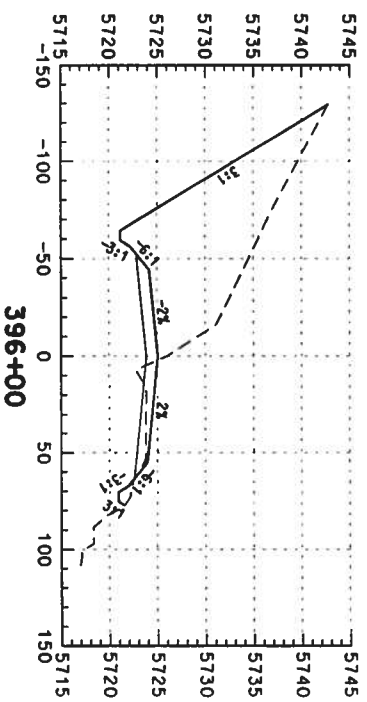
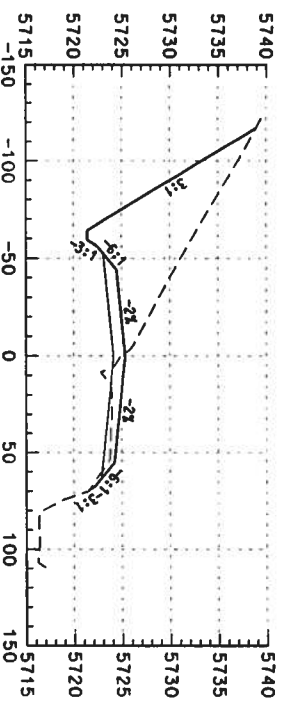
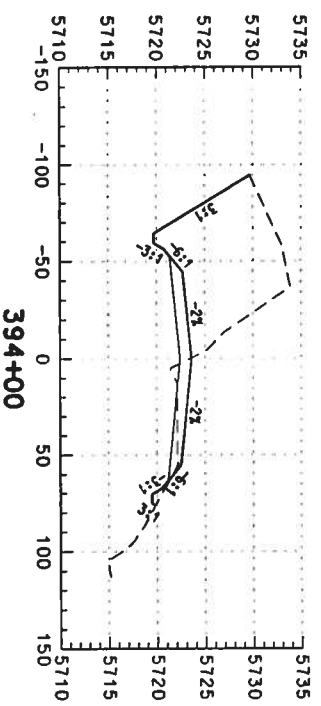
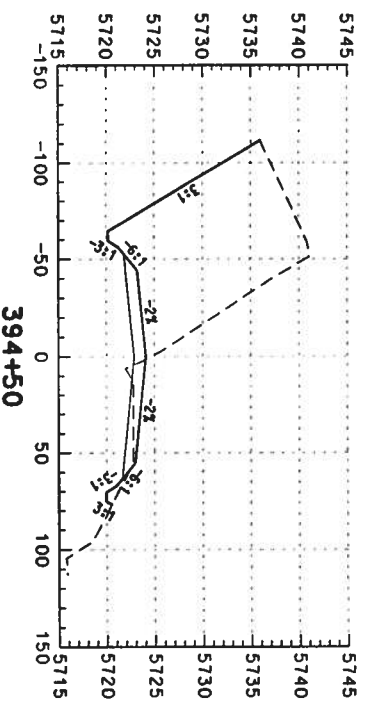
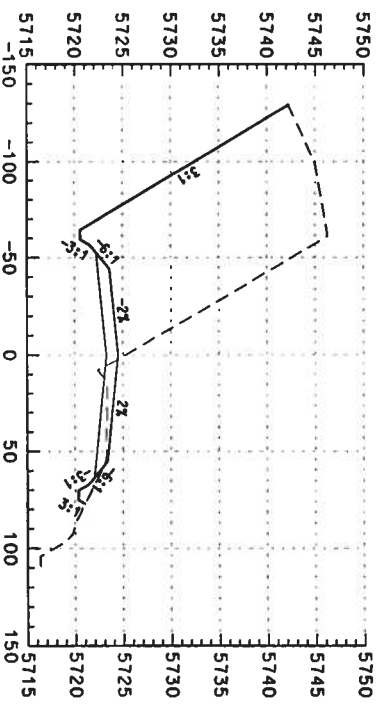

Computer File Information

Creation Date: 02/14/03 Initials: DAF
 Last Modification Date: Initials:
 Full Path: S:\Transport\246042\Hydes\Plans\
 Drawing File Name: rdxs-so-2d079.dgn
 Scale: Units: ENGLISH

Index of Revisions



359 Inverness Dr. South
 Suite K
 Englewood, CO 80112
 Phone: (303) 790-1020
 Fax: (303) 790-1037



5500 Greenwood Plaza Blvd.
 Suite 150
 Greenwood Village, CO 80111
 Phone: 303/221-7275
 Fax: 303/221-7276

As Constructed



No. Revisions:
 Revised:
 Void:

US 85 CROSS SECTIONS

Designer: DAF
 Detailer: DAF
 Sheet Subset: Roadway

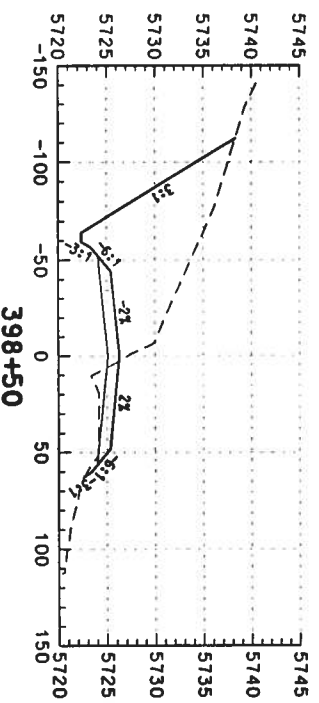
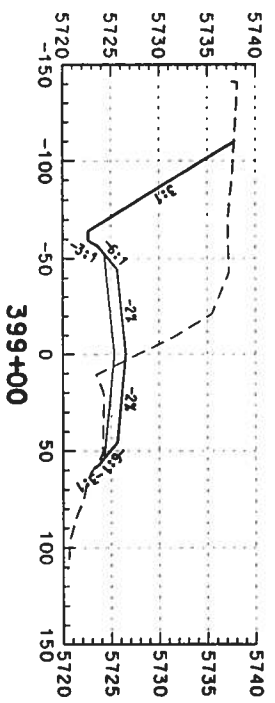
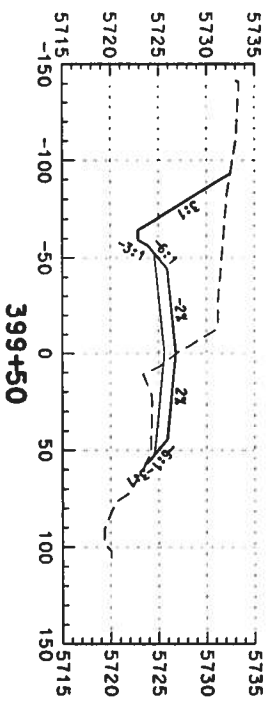
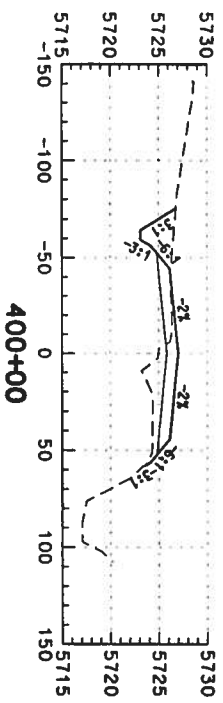
Project No./Code
 NH 0852-086
 13429
 Sheet Number: 378



Computer File Information		Index of Revisions		 <p>359 Inverness Dr. South Suite K Englewood, CO 80112 Phone: (303) 790-1020 Fax: (303) 790-1037</p>		 <p>5500 Greenwood Plaza Blvd. Suite 150 Greenwood Village, CO 80111 Phone: 303/221-7275 Fax: 303/221/7276</p>																																					
Creation Date:	02/14/03	hittide:	DAF					<table border="1"> <tr><td> </td><td> </td></tr> <tr><td> </td><td> </td></tr> <tr><td> </td><td> </td></tr> <tr><td> </td><td> </td></tr> <tr><td> </td><td> </td></tr> </table>																																			
Lost Modification Date:		hittids:		REGION 1		As Constructed																																					
Full Path:	S:\Tranproj\ 246042.12\HyDes\Plans\			<table border="1"> <tr> <td>No. Revisions:</td> <td> </td> <td>Designer:</td> <td>DAF</td> <td>Structure</td> <td> </td> </tr> <tr> <td>Revised:</td> <td> </td> <td>Detailer:</td> <td>DAF</td> <td>Numbers</td> <td> </td> </tr> <tr> <td>Void:</td> <td> </td> <td>Sheet Subset:</td> <td>Roadway</td> <td>Subset Sheets:</td> <td> of </td> </tr> </table>		No. Revisions:		Designer:	DAF	Structure		Revised:		Detailer:	DAF	Numbers		Void:		Sheet Subset:	Roadway	Subset Sheets:	of	<table border="1"> <tr> <td colspan="2">US 85 CROSS SECTIONS</td> <td rowspan="2">Project No./Code</td> </tr> <tr> <td> </td> <td> </td> <td>NH 0852-086</td> </tr> <tr> <td>Drawing File Name:</td> <td>rds-so-2d080.dgn</td> <td>Units:</td> <td>ENGLISH</td> <td>Sheet Number:</td> <td>13429</td> </tr> <tr> <td>Scale:</td> <td></td> <td></td> <td></td> <td></td> <td>379</td> </tr> </table>		US 85 CROSS SECTIONS		Project No./Code			NH 0852-086	Drawing File Name:	rds-so-2d080.dgn	Units:	ENGLISH	Sheet Number:	13429	Scale:					379
No. Revisions:		Designer:	DAF	Structure																																							
Revised:		Detailer:	DAF	Numbers																																							
Void:		Sheet Subset:	Roadway	Subset Sheets:	of																																						
US 85 CROSS SECTIONS		Project No./Code																																									
			NH 0852-086																																								
Drawing File Name:	rds-so-2d080.dgn	Units:	ENGLISH	Sheet Number:	13429																																						
Scale:					379																																						

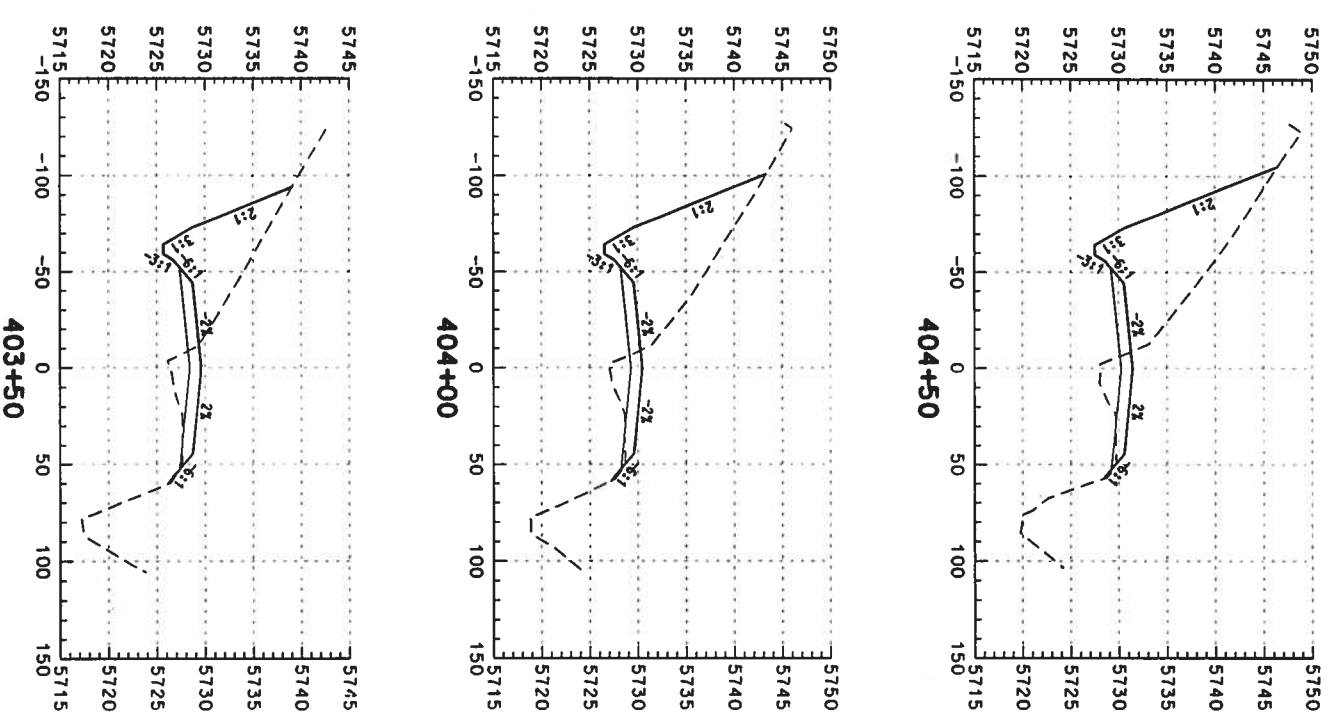
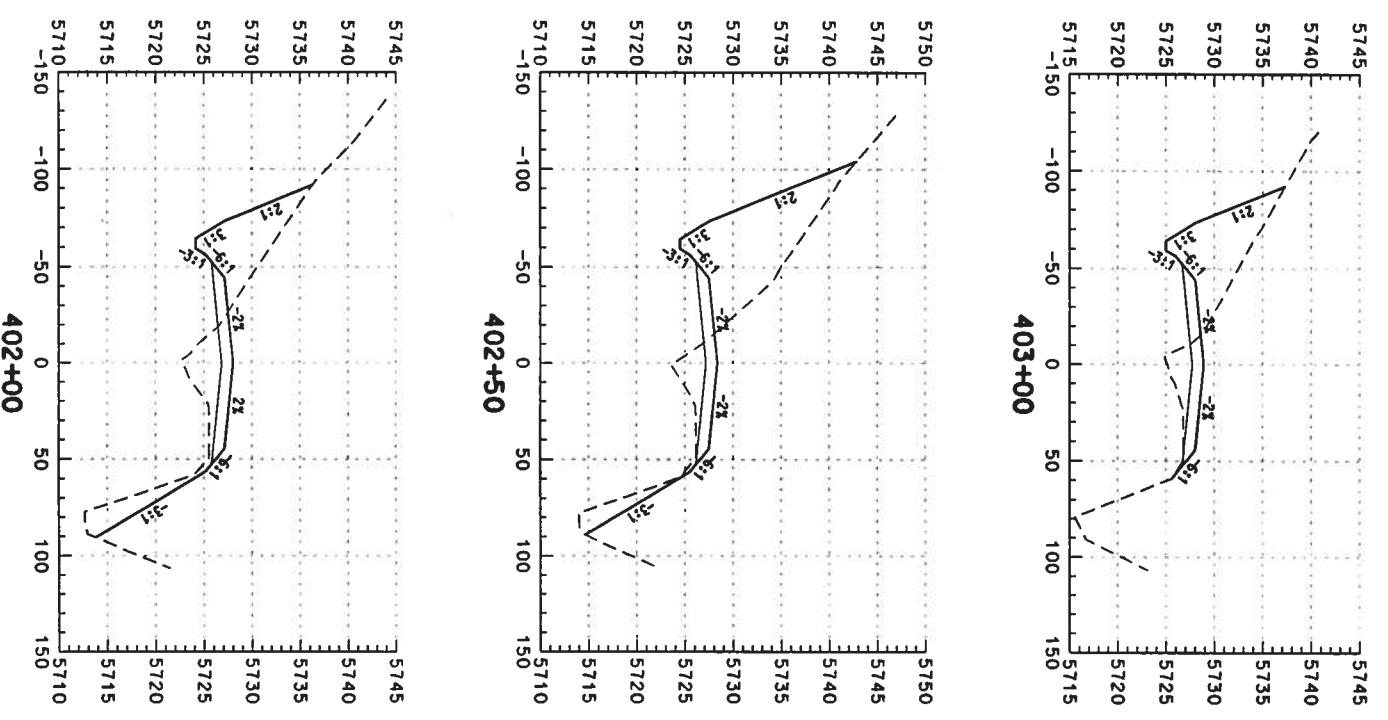
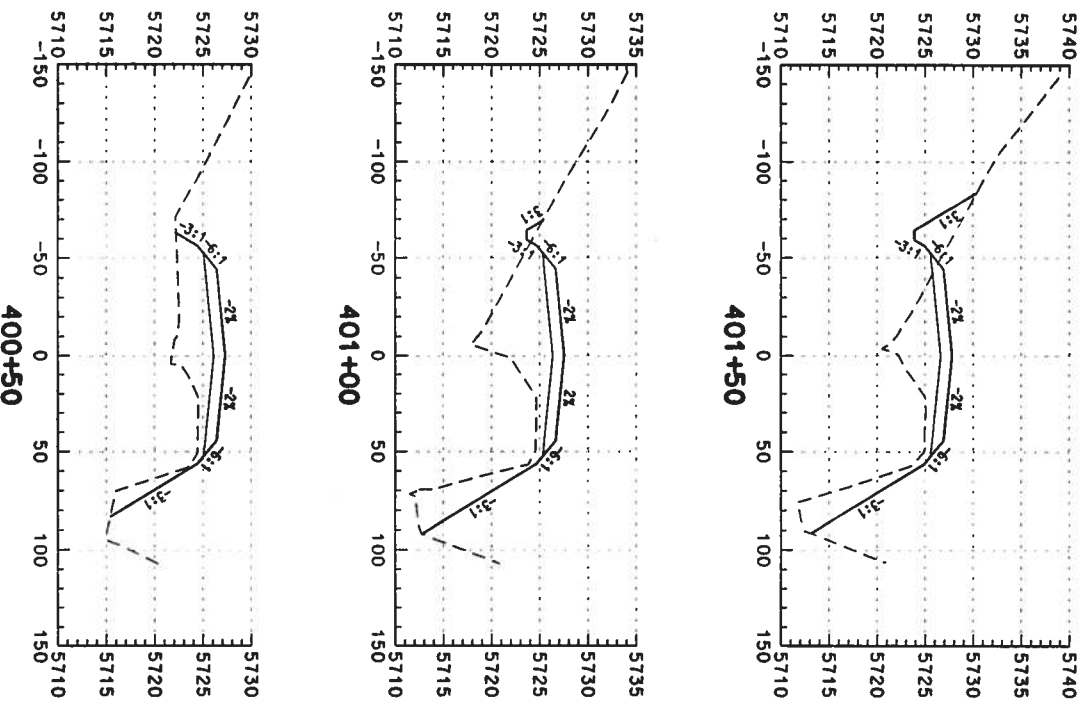

Computer File Information
 Creation Date: 02/14/03 Initials: DAF
 Last Modification Date: Initials:
 Full Path: S:\Transport\24604212\HwyDes\Plans\
 Drawing File Name: rdxs-so-2d081.dgn
 Scale: Units: ENGLISH

Index of Revisions



REGION 1
 359 Inverness Dr. South
 Suite K
 Englewood, CO 80112
 Phone: (303) 790-1020
 Fax: (303) 790-1037



5500 Greenwood Plaza Blvd.
 Suite 150
 Greenwood Village, CO 80111
 Phone: 303/221-7275
 Fax: 303/221-7276

As Constructed

No. Revisions:	
Revised:	
Void:	

US 85 CROSS SECTIONS

Designer:	DAF	Structure	
Detailer:	DAF	Numbers	
Sheet Subset:	Roadway	Subset Sheets:	of

Project No./Code
 NH 0852-086
 13429
 Sheet Number: 380

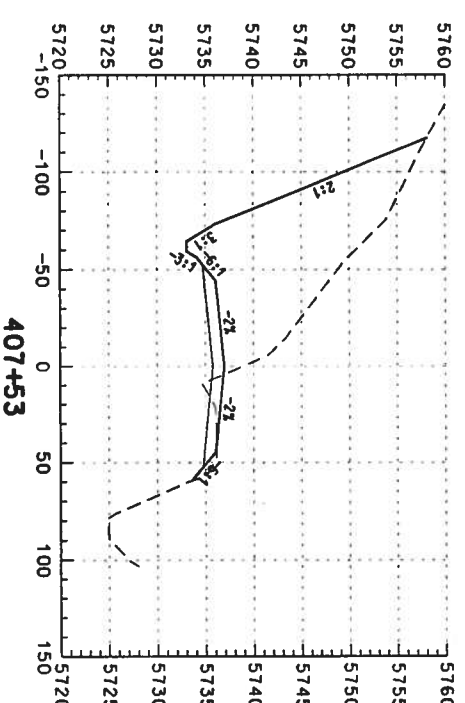
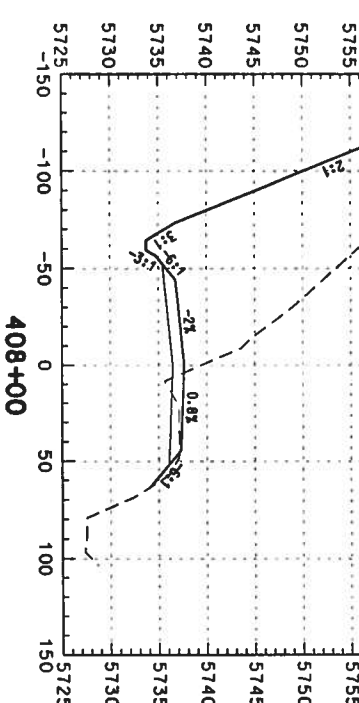
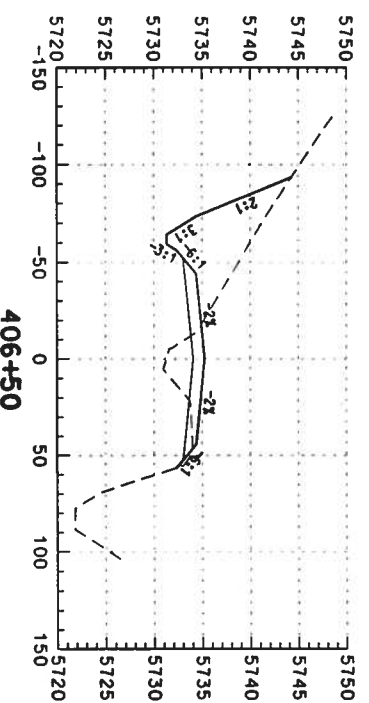
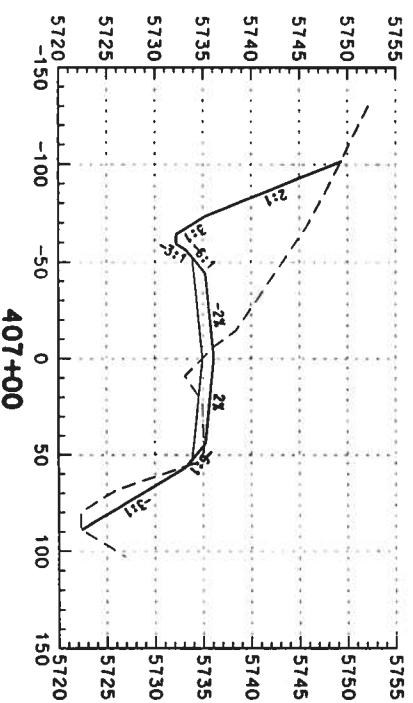
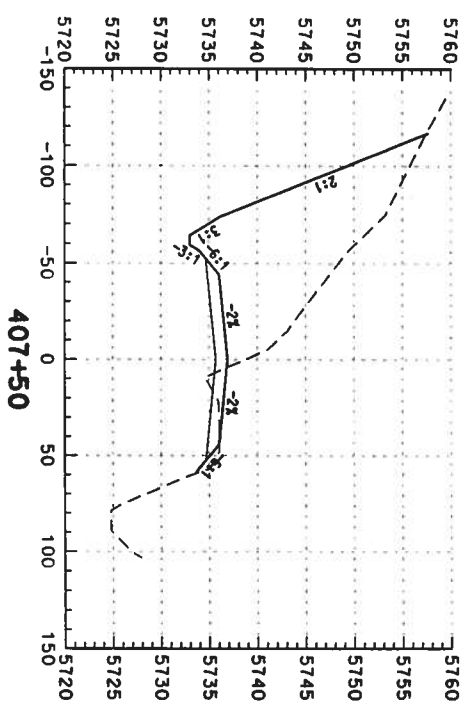
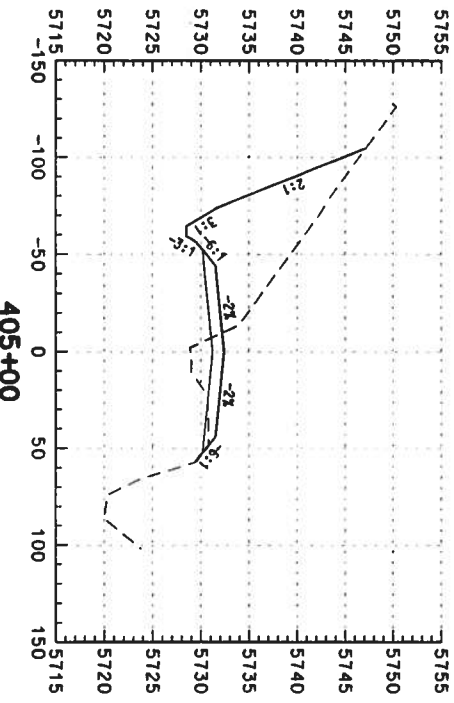
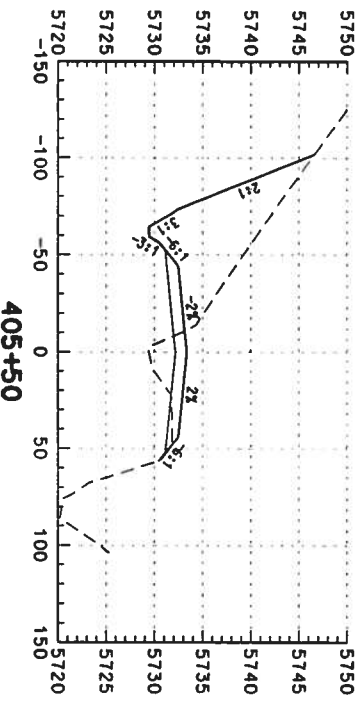
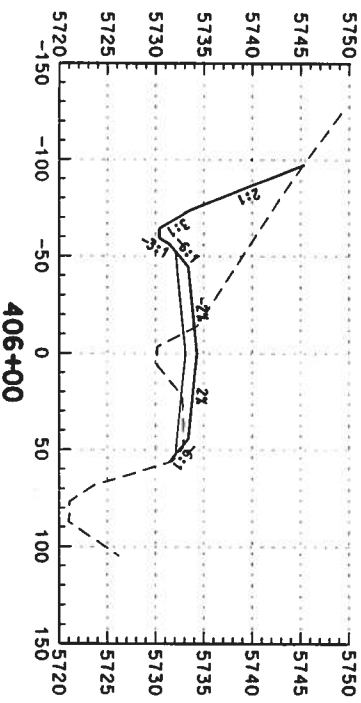

Computer File Information
 Creation Date: 02/14/03 Initials: DAF
 Last Modification Date: Initials:
 Full Path: S:\Temp\proj\246042.12\HwyDes\Plans\
 Drawing File Name: rdxs-so-24082.dgn
 Scale: Units: ENGLISH

Index of Revisions



359 Inverness Dr. South
 Suite K
 Englewood, CO 80112
 Phone: (303) 790-1020
 FAX: (303) 790-1037

REGION 1



5500 Greenwood Plaza Blvd.
 Suite 150
 Greenwood Village, CO 80111
 Phone: 303/221-7275
 Fax: 303/221/7276

As Constructed

No. Revisions:	
Revised:	
Void:	

US 85 CROSS SECTIONS

Designer:	DAF
Detailer:	DAF
Sheet Subset:	Roadway
Structure Numbers:	
Subset Sheets:	
	of

Project No./Code

NH 0852-086
13429
Sheet Number: 381

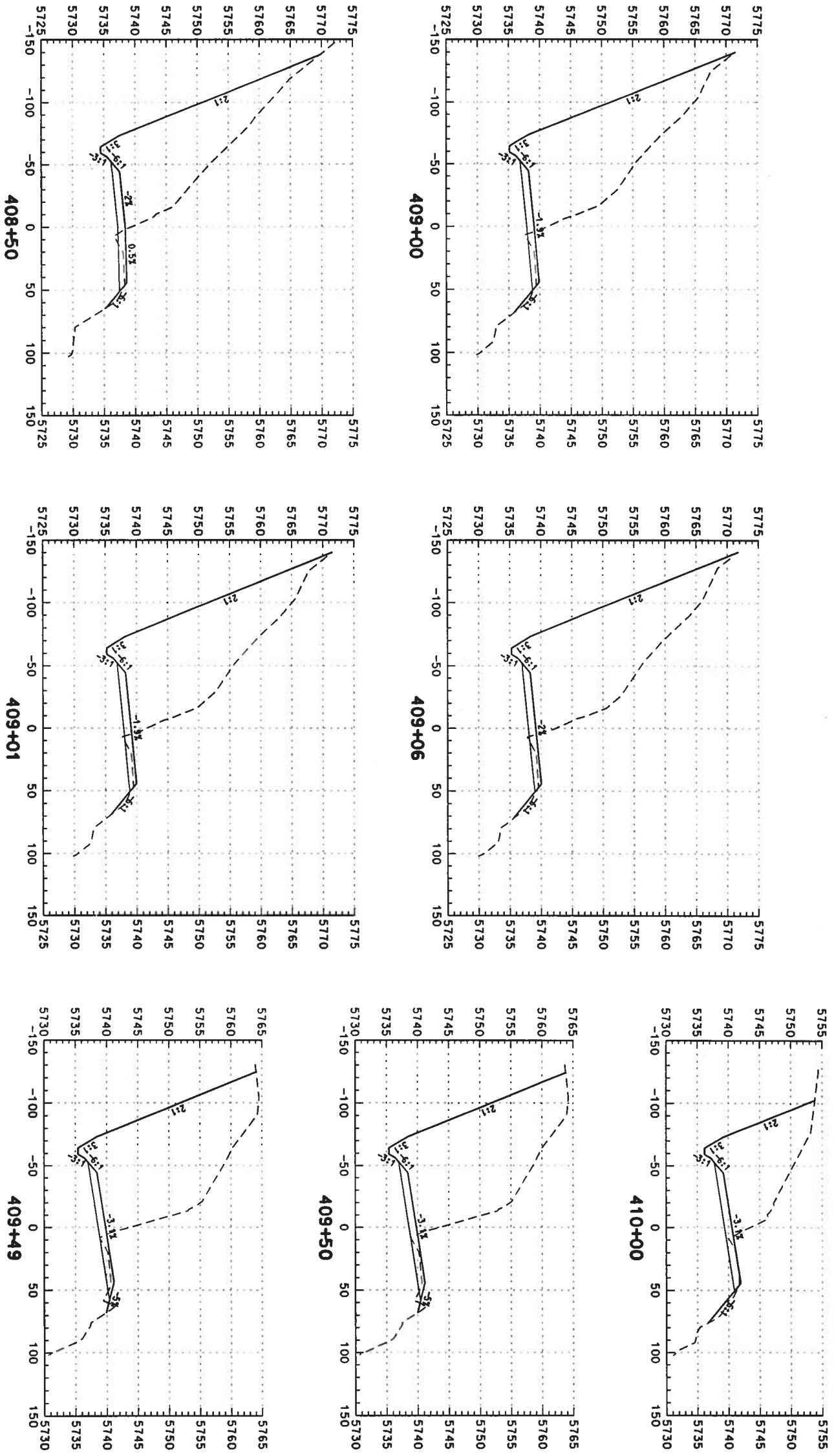

Computer File Information

Creation Date: 02/14/03 Initials: DAF
 Last Modification Date: Initials:
 Full Path: S:\Temp\o\246042.HwyDes\Plans\
 Drawing File Name: rdxs-so-24083.dgn
 Scale: Units: ENGLISH

Index of Revisions

No.	Description

DOT
 DEPARTMENT OF TRANSPORTATION
 359 Inverness Dr. South
 Suite K
 Englewood, CO 80112
 Phone: (303) 790-1020
 FAX: (303) 790-1037

REGION 1

PBSJ
 5500 Greenwood Plaza Blvd.
 Suite 150
 Greenwood Village, CO 80111
 Phone: 303/221-7275
 Fax: 303/221-7276

As Constructed

No. Revisions:	
Revised:	
Void:	

US 85 CROSS SECTIONS

Designer: DAF
 Detailer: DAF
 Sheet Subset: Roadway Subset Sheets: of

Project No./Code
 NH 0852-086
 Sheet Number: 382

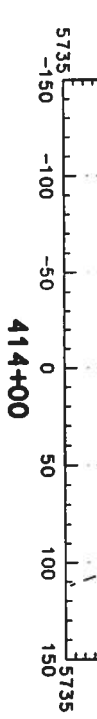
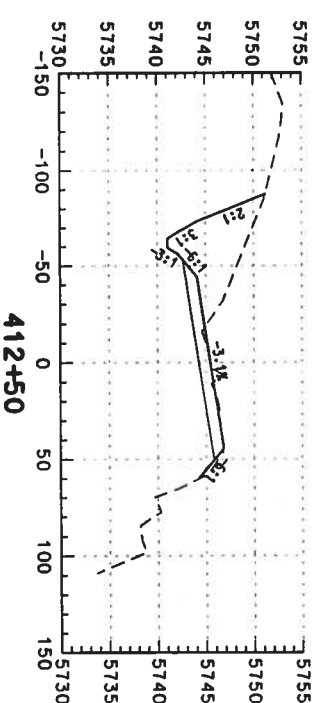
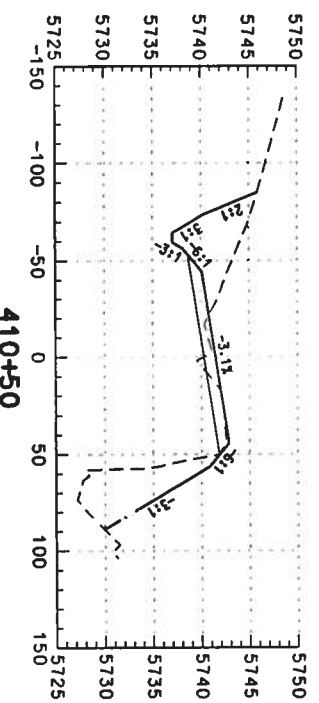
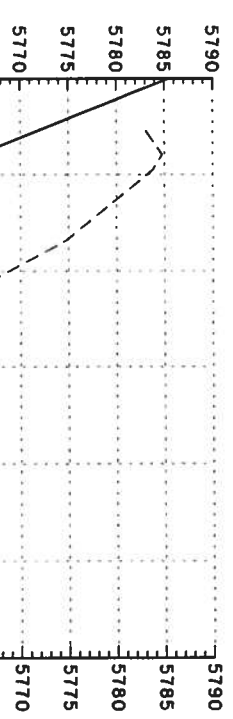
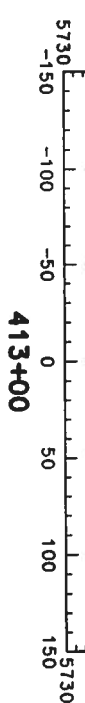
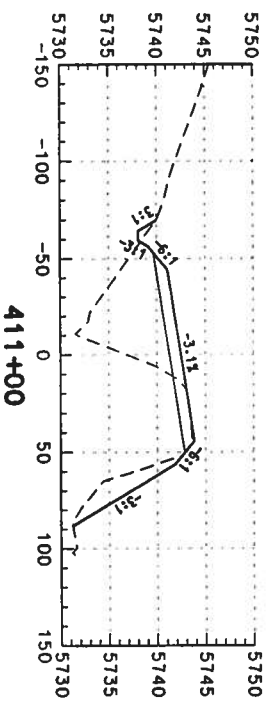
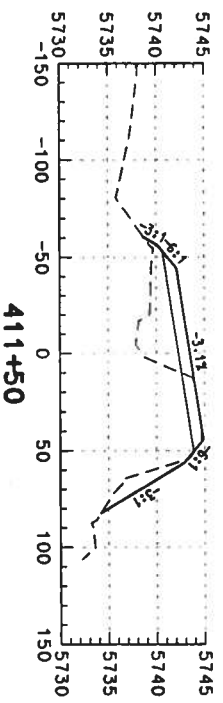
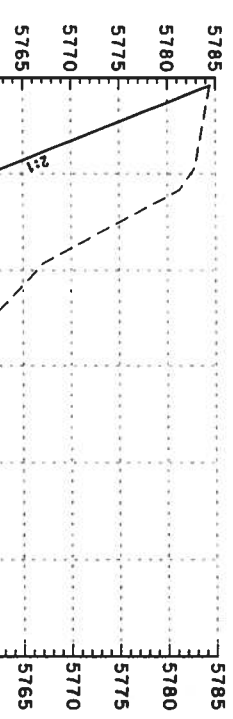
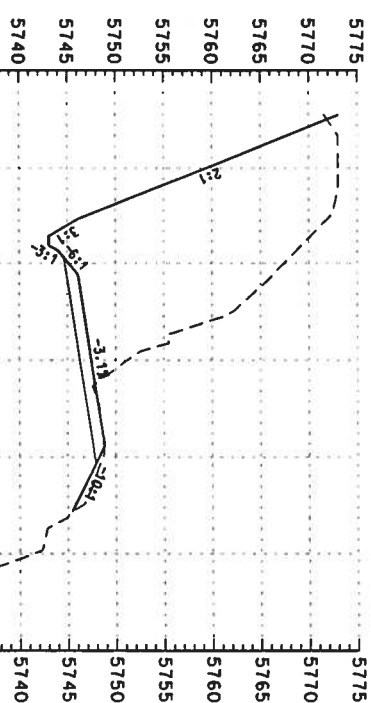
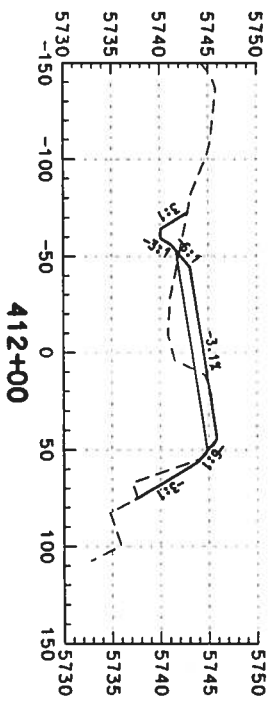

Computer File Information

Creation Date: 02/14/03 Initials: DAF
 Last Modification Date: Initials:
 Full Path: S:\Tranpro\246042\Hydes\Plans\
 Drawing File Name: rdxs-so-2d084.dgn
 Scale: Units: ENGLISH

Index of Revisions



339 Inverness Dr. South
 Suite K
 Englewood, CO 80112
 Phone: (303) 790-1020
 FAX: (303) 790-1037



5500 Greenwood Plaza Blvd.
 Suite 150
 Greenwood Village, CO 80111
 Phone: 303/221-7275
 Fax: 303/221/7276

As Constructed

No. Revisions:	
Revised:	
Void:	

US 85 CROSS SECTIONS

Designer:	DAF	Structure	
Detailer:	DAF	Numbers	
Sheet Subset:	Roadway	Subset Sheets:	
		of	

Project No./Code
 NH 0852-086

Sheet Number:
 13429
 383

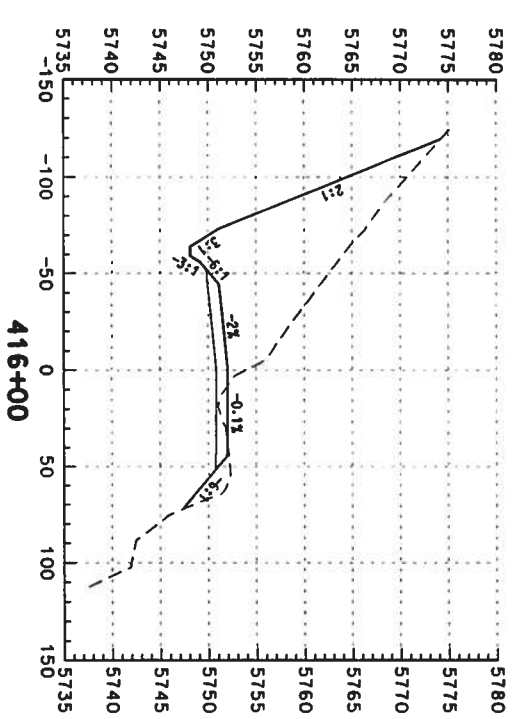
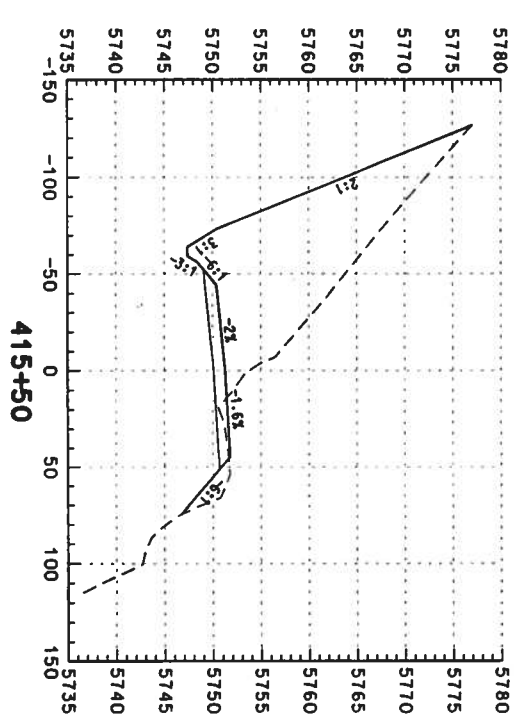
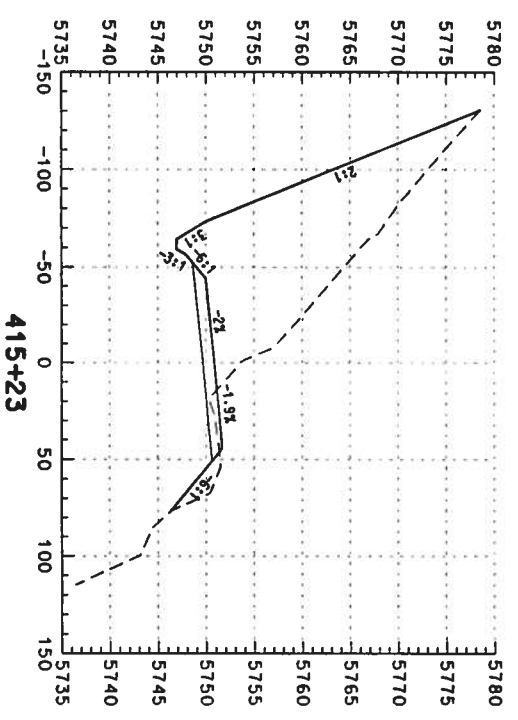
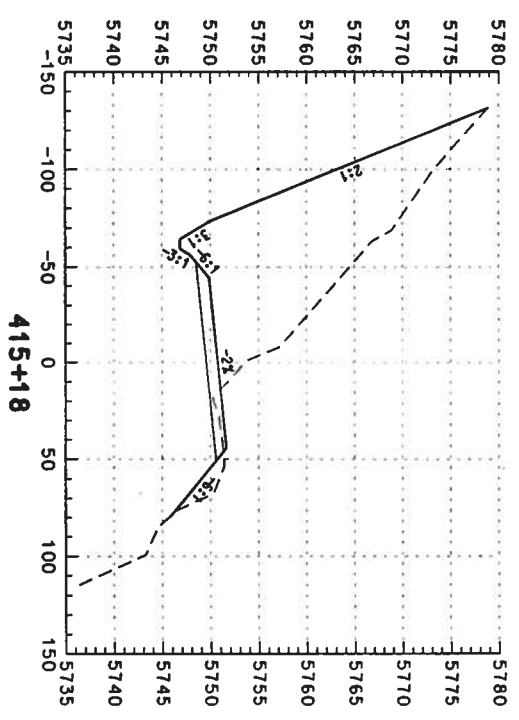
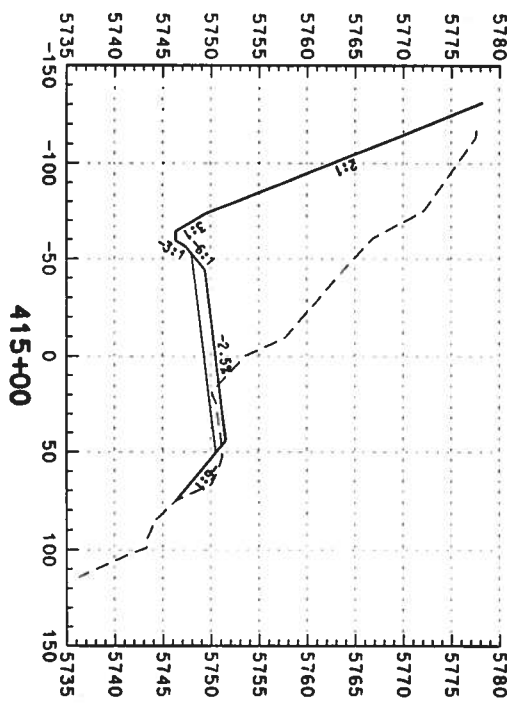
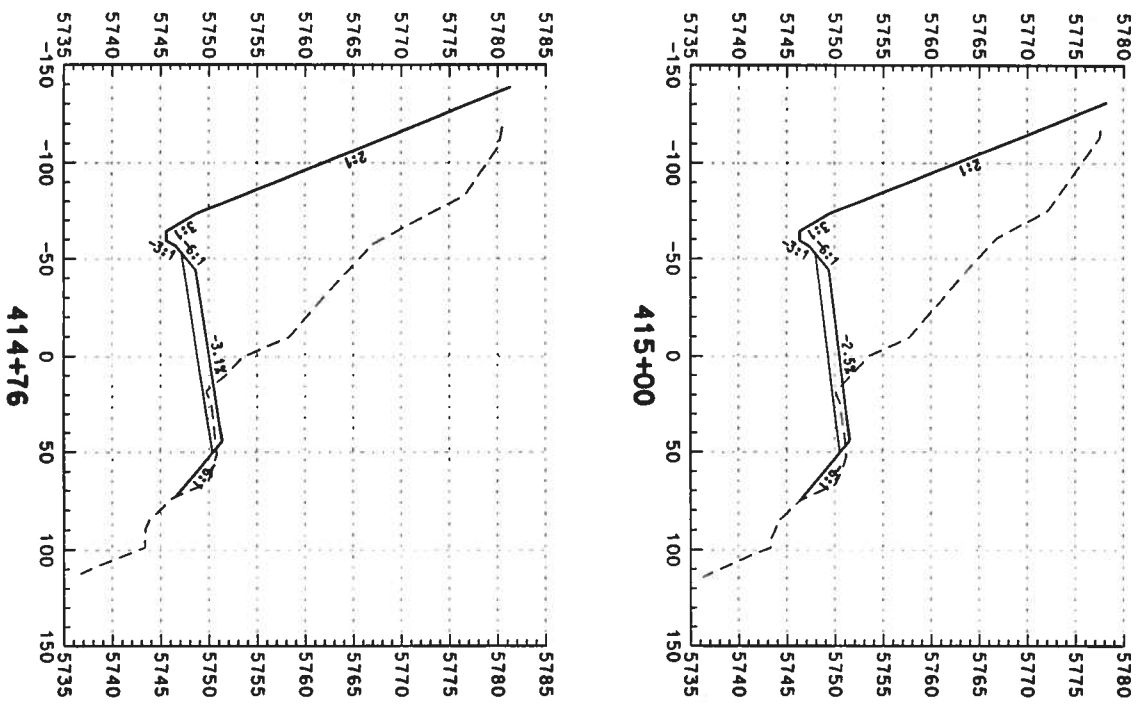

Computer File Information
 Creation Date: 02/14/03 Initials: DAF
 Last Modification Date: Initials:
 Full Path: S:\Transport\246042\HW\Des\Plans\
 Drawing File Name: rdxs-so-24085.dgn
 Scale: Units: ENGLISH

Index of Revisions

DOT
 DEPARTMENT OF TRANSPORTATION
 REGION I
 359 Inverness Dr. South
 Suite K
 Englewood, CO 80112
 Phone: (303) 790-1020
 Fax: (303) 790-1037

PBS&J
 5500 Greenwood Plaza Blvd.
 Suite 150
 Greenwood Village, CO 80111
 Phone: 303/221-7275
 Fax: 303/221/7276

As Constructed

No. Revisions:	
Revised:	
Void:	

US 85 CROSS SECTIONS

Designer:	DAF	Structure	
Detailer:	DAF	Numbers	
Sheet Subset:	Roadway	Subset Sheets:	

Project No./Code
 NH 0852-086
 13429
 Sheet Number: 384

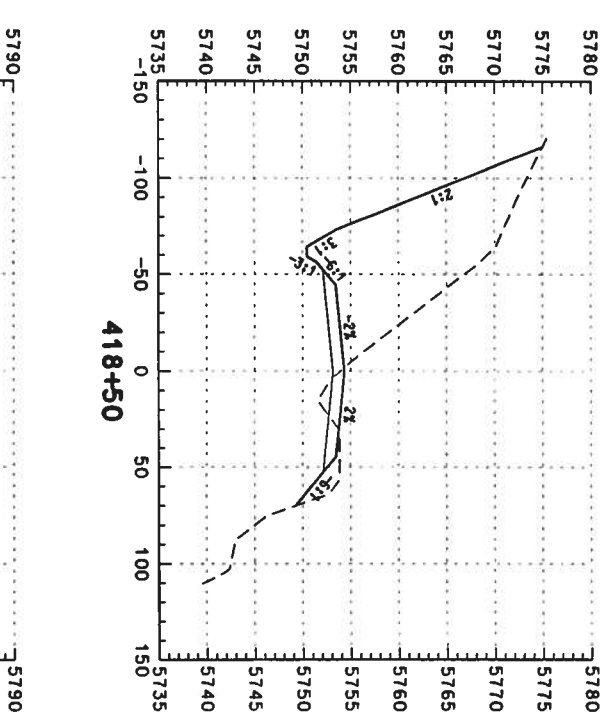
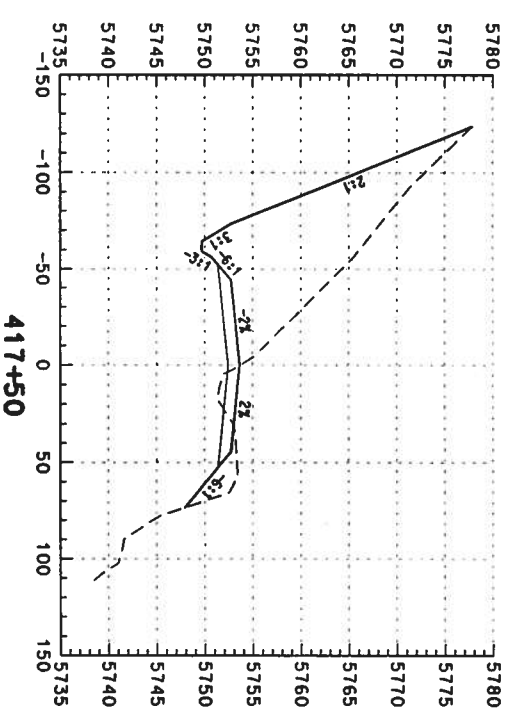
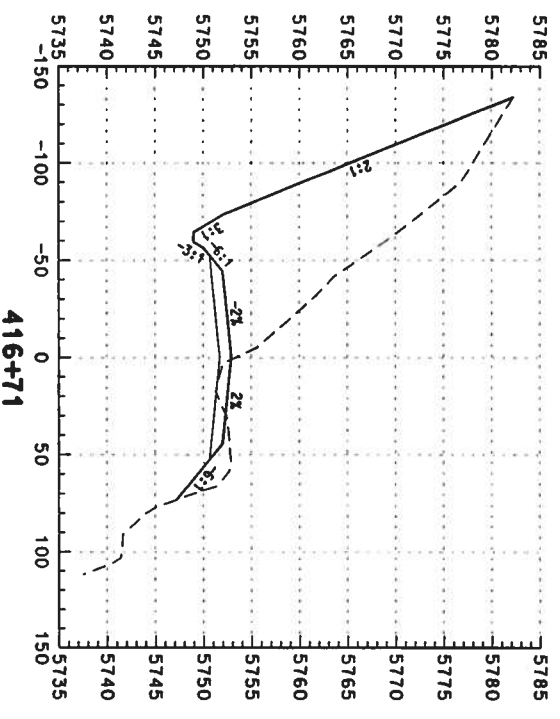
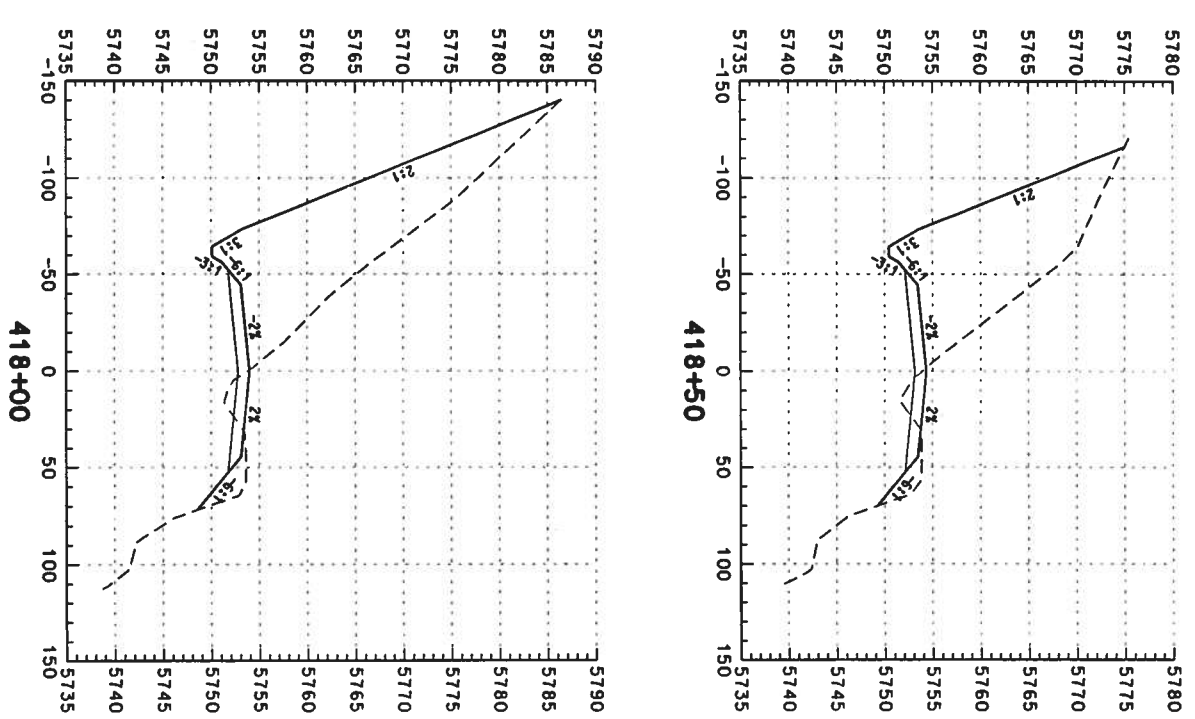
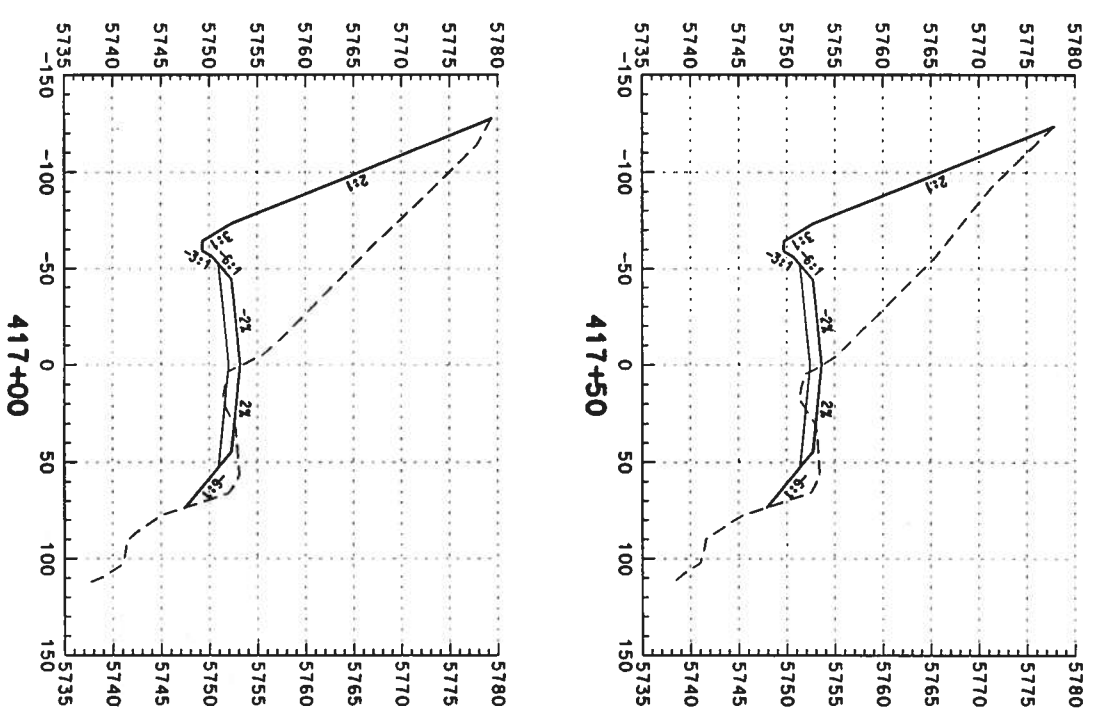
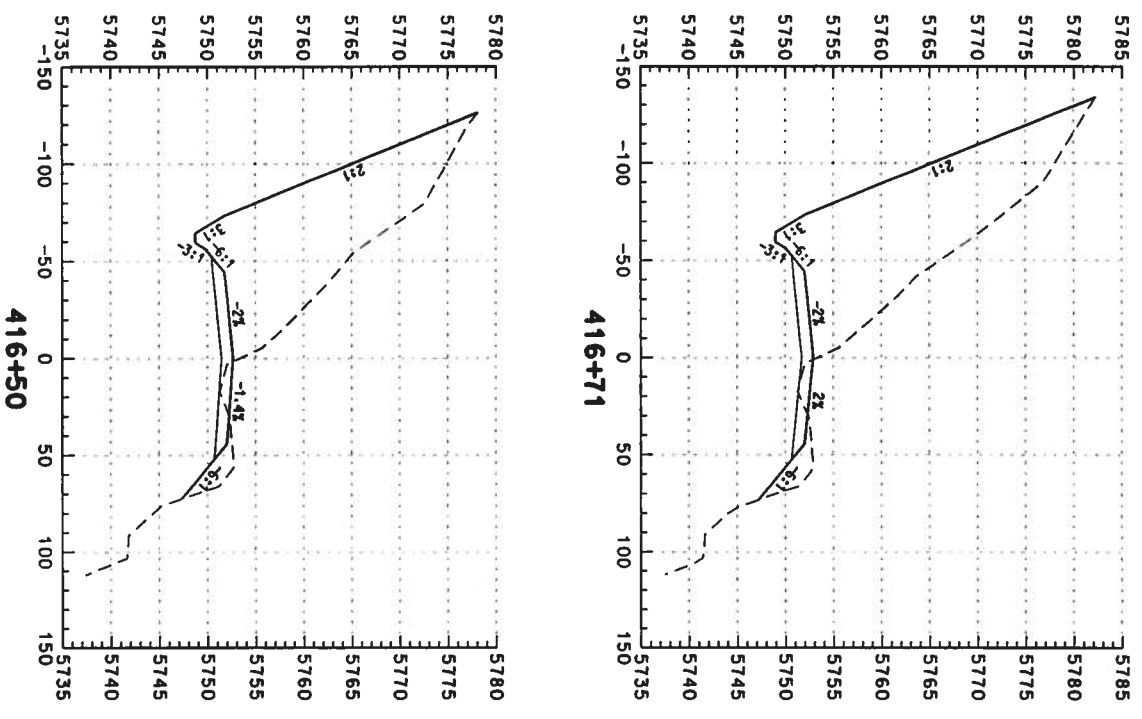

Computer File Information
 Creation Date: 02/14/03 Initials: DAF
 Last Modification Date: Initials:
 Full Path: S:\Tranproj\24604212\Hydes\Plans\
 Drawing File Name: rdxs-so-2d086.dgn
 Scale: Units: ENGLISH

Index of Revisions

DOT
 DEPARTMENT OF TRANSPORTATION
 REGION 1
 359 Inverness Dr. South
 Suite K
 Englewood, CO 80112
 Phone: (303) 790-1020
 Fax: (303) 790-1037

PBSJ
 5500 Greenwood Plaza Blvd.
 Suite 150
 Greenwood Village, CO 80111
 Phone: 303/221-7275
 Fax: 303/221/7276

As Constructed

No. Revisions:	
Revised:	
Void:	

US 85 CROSS SECTIONS
 Designer: DAF
 Detailer: DAF
 Sheet Subset: Roadway
 Structure Numbers
 Subset Sheets: of

Project No./Code
 NH 0852-086
 13429
 Sheet Number: 385

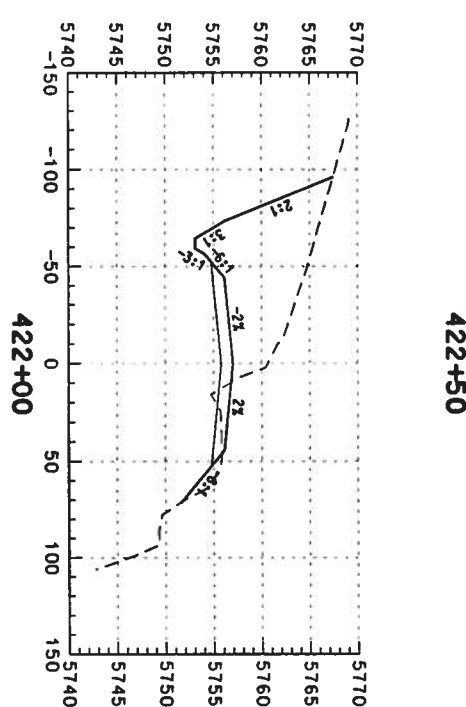
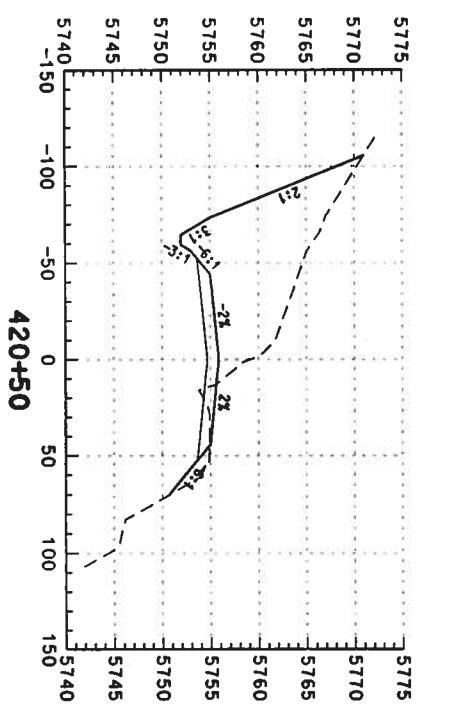
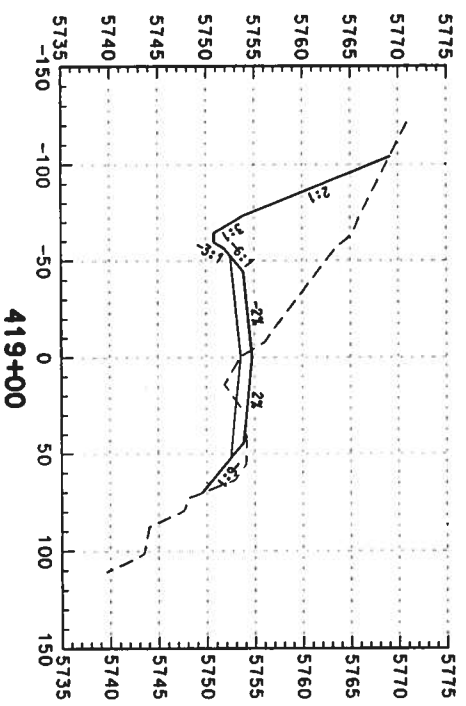
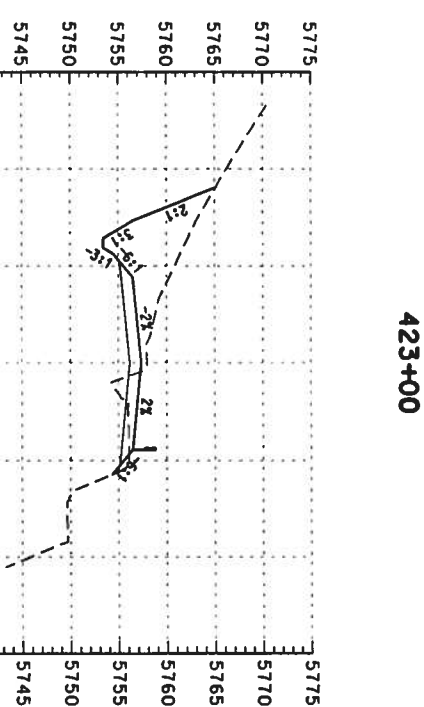
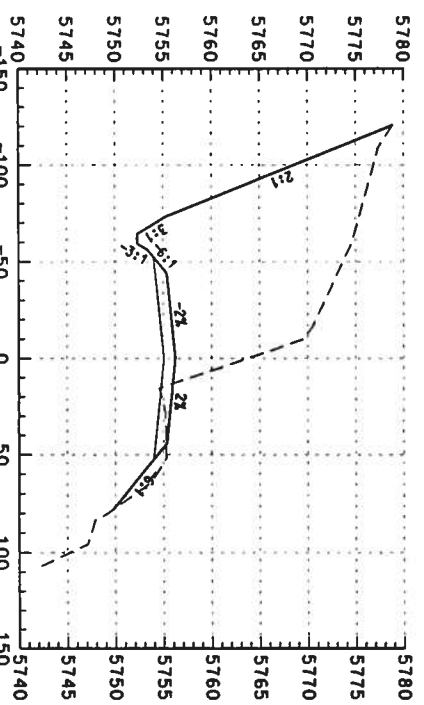
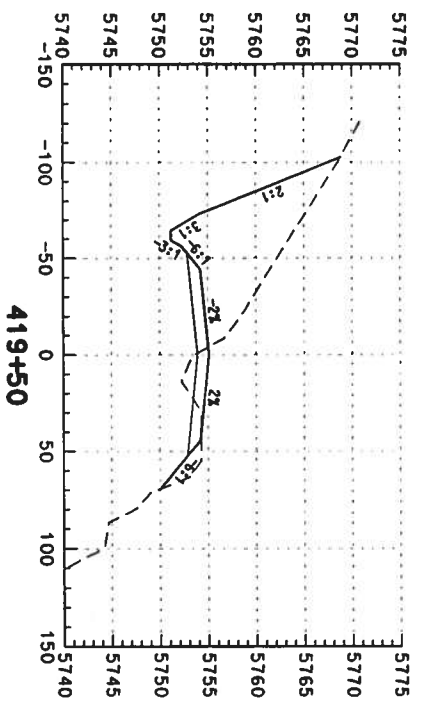
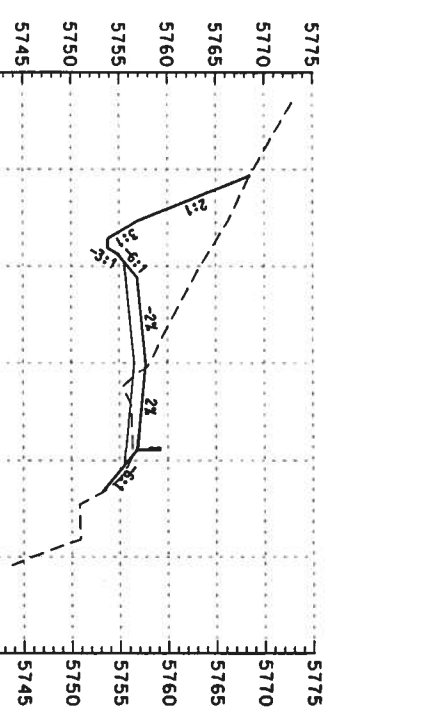
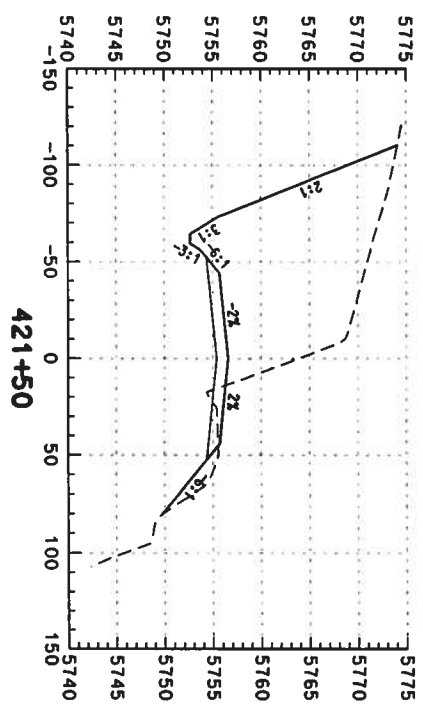
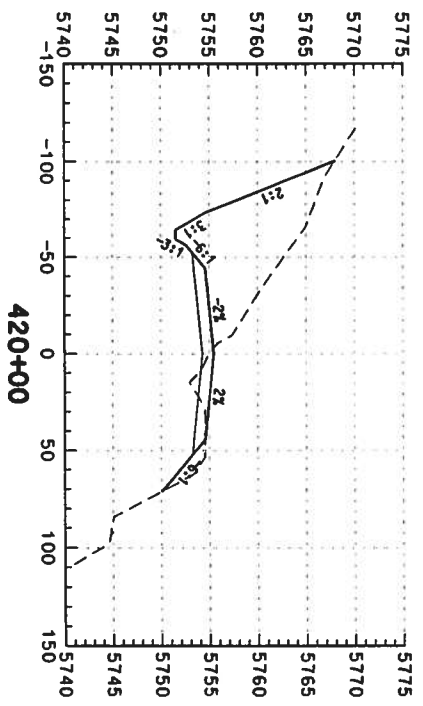

Computer File Information	
Creation Date:	02/14/03
Initials:	DAF
Last Modification Date:	
Initials:	
Full Path:	S:\Trompro\246042\Hydres\Plans\
Drawing File Name:	rdxs-so-2d087.dgn
Scale:	Units: ENGLISH

Index of Revisions	

DOT
DEPARTMENT OF TRANSPORTATION

REGION 1

339 Inverness Dr. South
Suite K
Englewood, CO 80112
Phone: (303) 790-1020
Fax: (303) 790-1037

PRSI

5500 Greenwood Plaza Blvd.
Suite 150
Greenwood Village, CO 80111
Phone: 303/221-7275
Fax: 303/221-7276

As Constructed	
No. Revisions:	
Revised:	
Void:	

US 85 CROSS SECTIONS	
Designer:	DAF
Detailer:	DAF
Structure Numbers	
Sheet Subset:	Roadway
Sheet Sheets:	
	of

Project No./Code	
NH 0852-086	
13429	
Sheet Number:	380

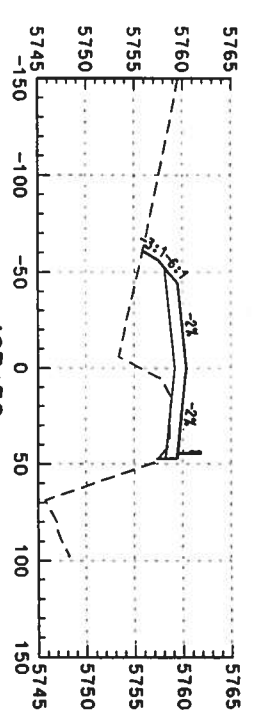
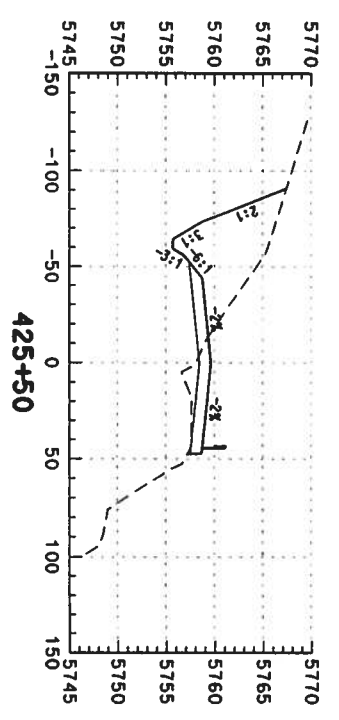
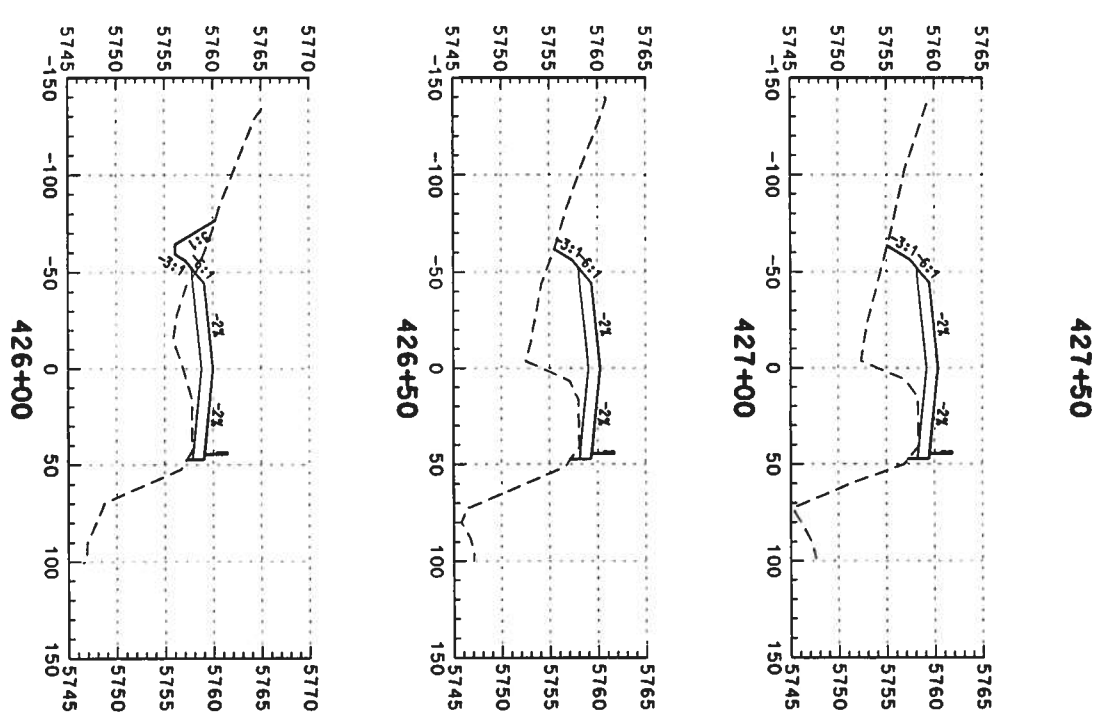
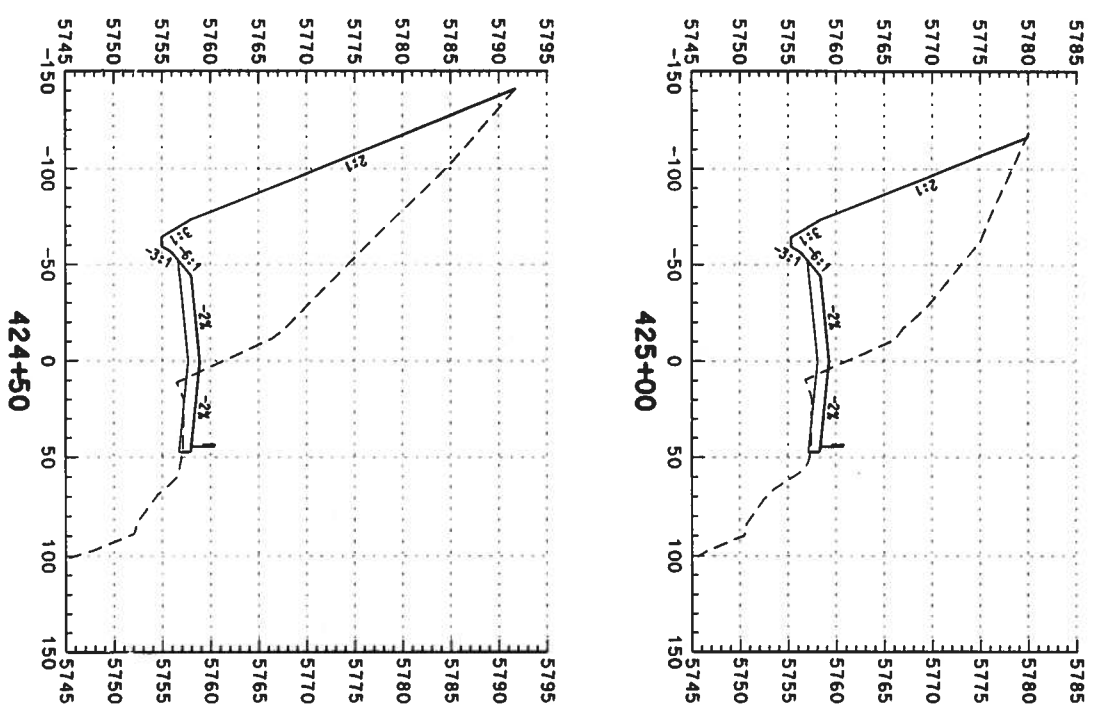
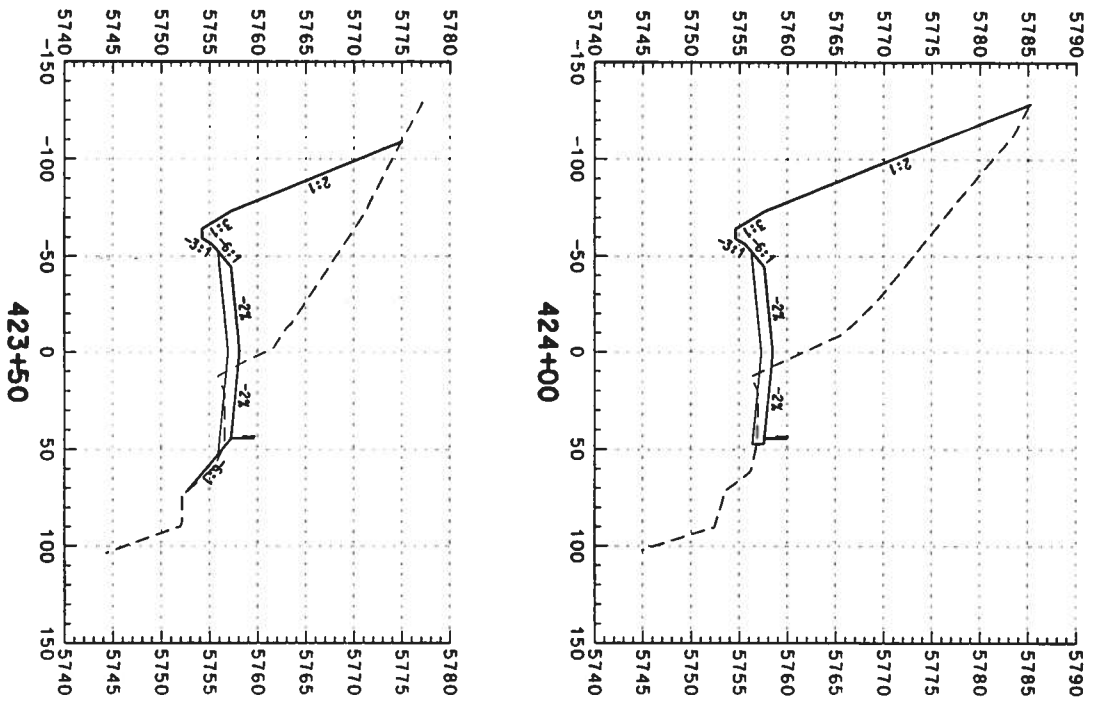

Computer File Information
 Creation Date: 02/14/03 Initials: DAF
 Last Modification Date: Initials:
 FullPath: S:\Temp\proj\246042.HwyDes\Plans\
 Drawing File Name: rdxs-so-24088.dgn
 Scale: Units: ENGLISH

Index of Revisions

DOT
 DEPARTMENT OF TRANSPORTATION
 REGION 1
 359 Inverness Dr. South
 Suite K
 Englewood, CO 80112
 Phone: (303) 790-1020
 Fax: (303) 790-1037

PBS&J
 5500 Greenwood Plaza Blvd.
 Suite 150
 Greenwood Village, CO 80111
 Phone: 303/221-7275
 Fax: 303/221/7276

As Constructed

No. Revisions:	
Revised:	
Void:	

US 85 CROSS SECTIONS

Designer:	DAF	Structure	
Detailer:	DAF	Numbers	
Sheet Subset:	Roadway	Subset Sheets:	

Project No./Code
 NH 0852-086
 13429
 Sheet Number: 387

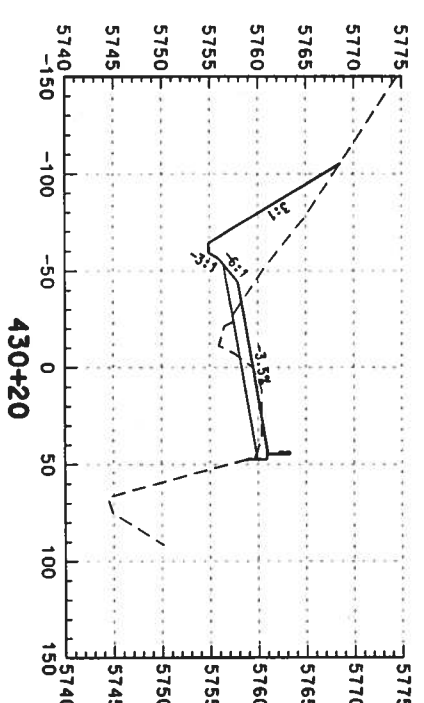
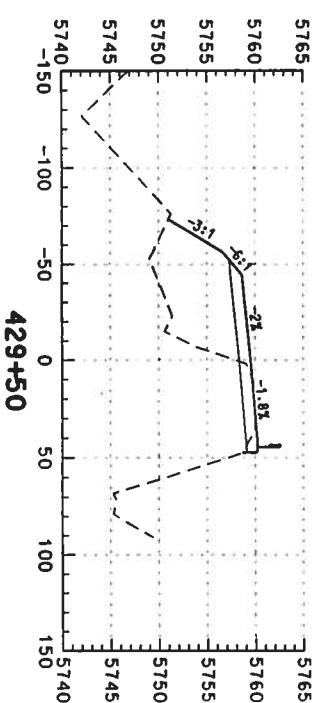
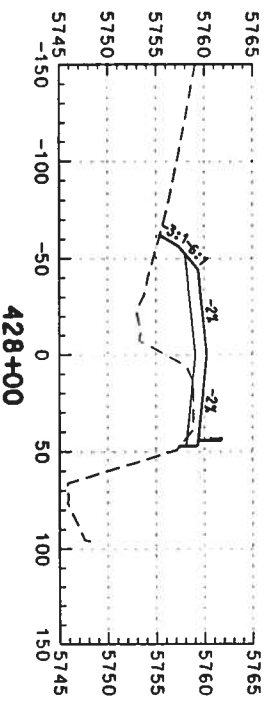
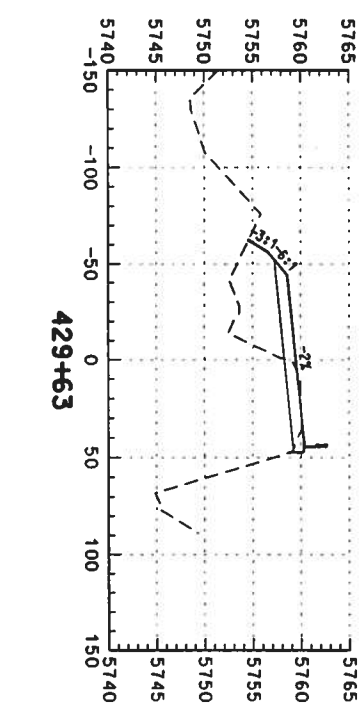
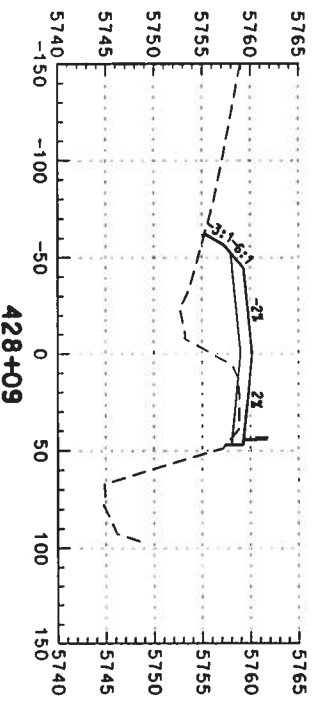
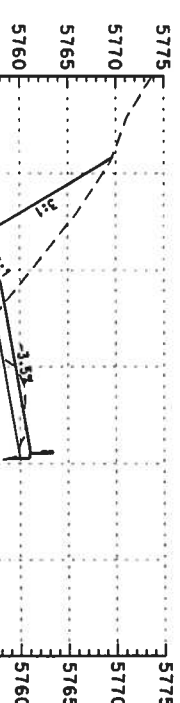
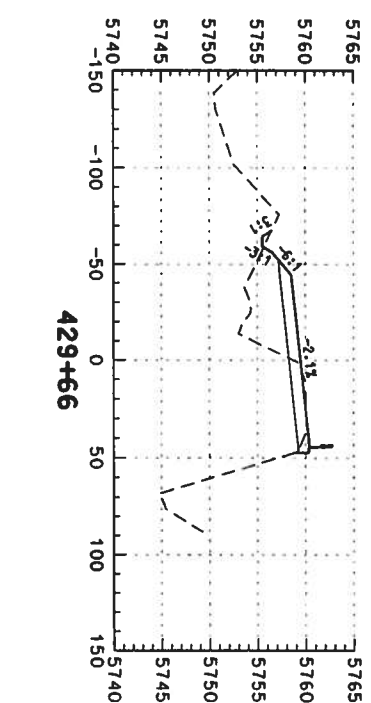
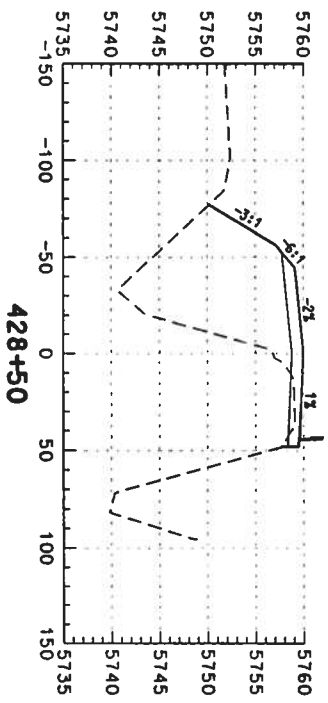
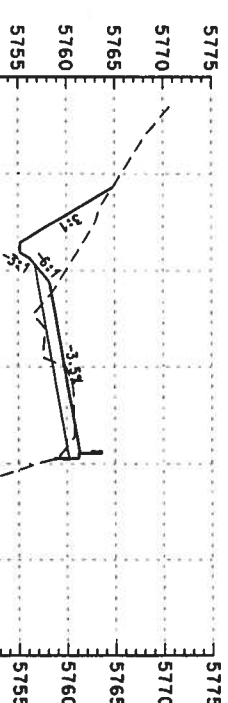
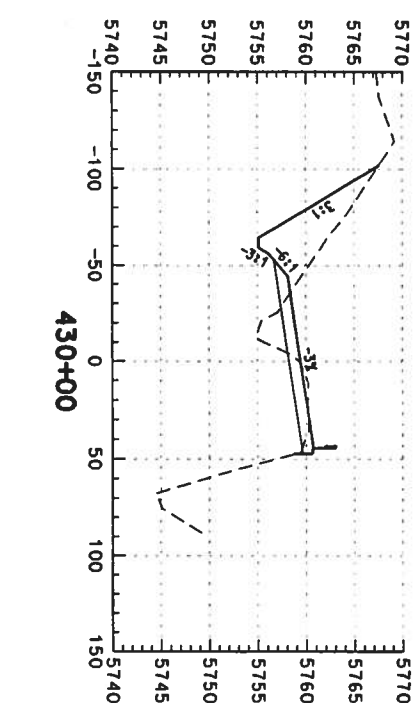
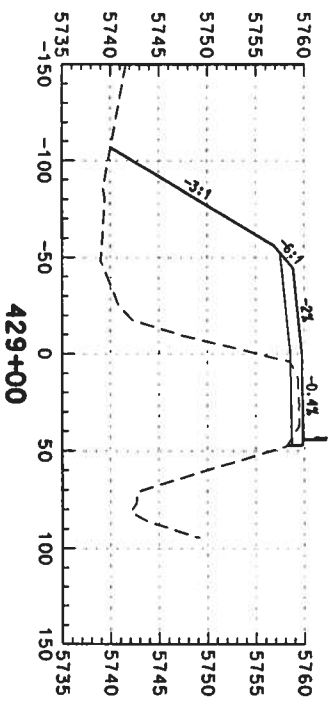

Computer File Information

Creation Date: 02/14/03 Initials: DAF
 Last Modification Date: Initials:
 Full Path: S:\Tranpro\246042.12\HwyDes\Plans\
 Drawing File Name: rdxs-so-24089.dgn
 Scale: Units: ENGLISH

Index of Revisions



359 Inverness Dr. South
 Suite K
 Englewood, CO 80112
 Phone: (303) 790-1020
 Fax: (303) 790-1037



5500 Greenwood Plaza Blvd.
 Suite 150
 Greenwood Village, CO 80111
 Phone: 303/221-7275
 Fax: 303/221-7276

As Constructed
 No. Revisions:
 Revised:
 Void:

US 85 CROSS SECTIONS
 Designer: DAF
 Checker: DAF
 Sheet Subsets: Roadway
 Subsets: Structure Numbers
 of

Project No./Code
 NH 0852-086
 Sheet Number: 388

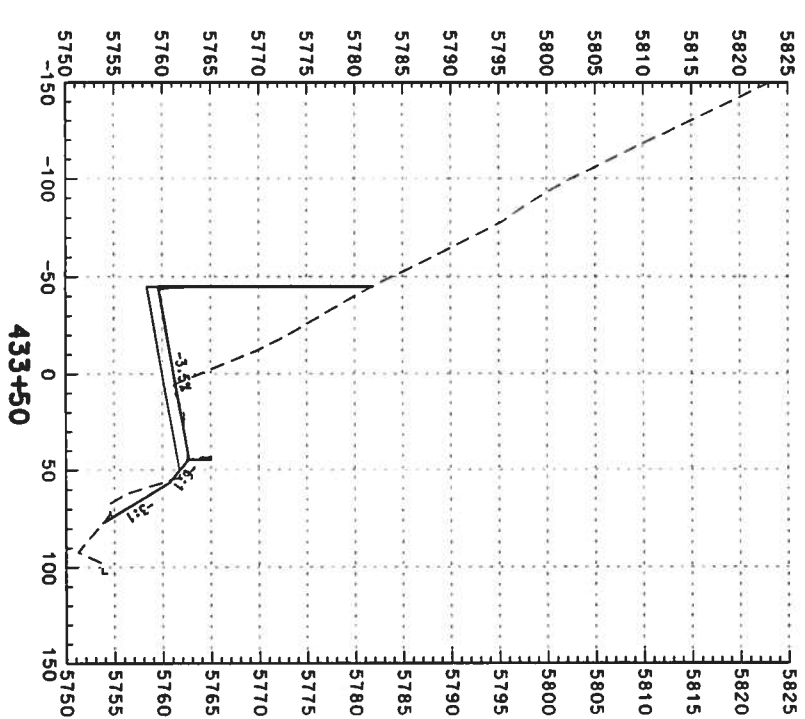
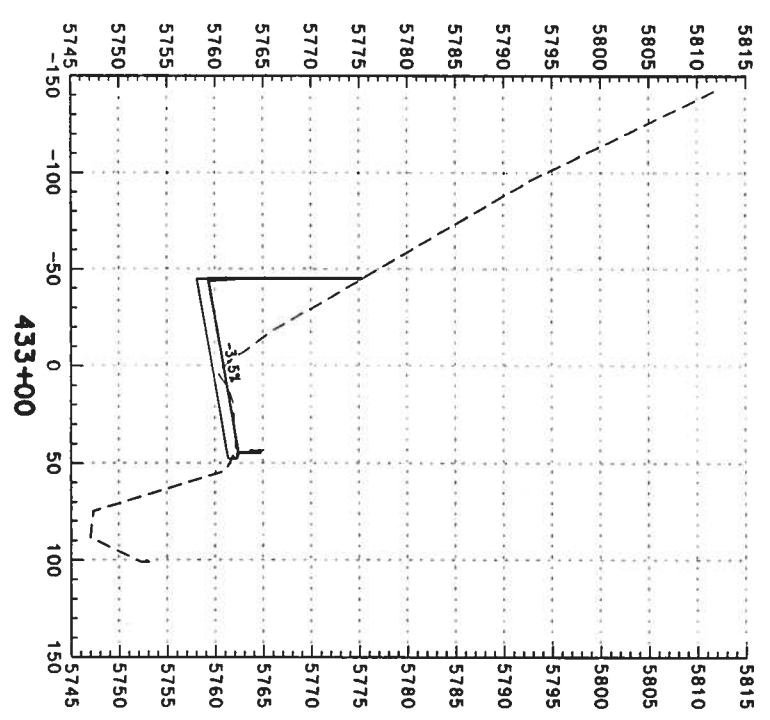
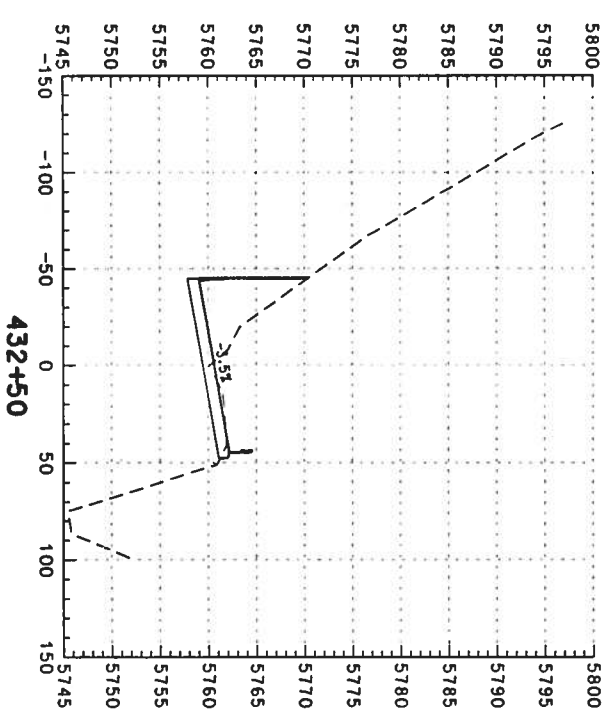
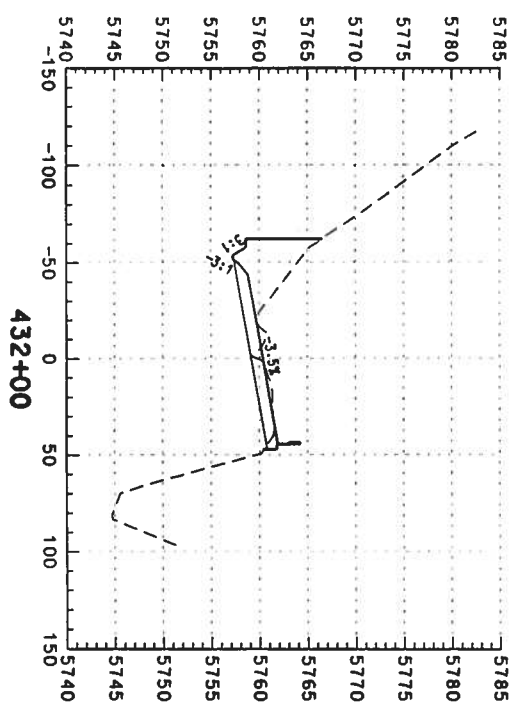
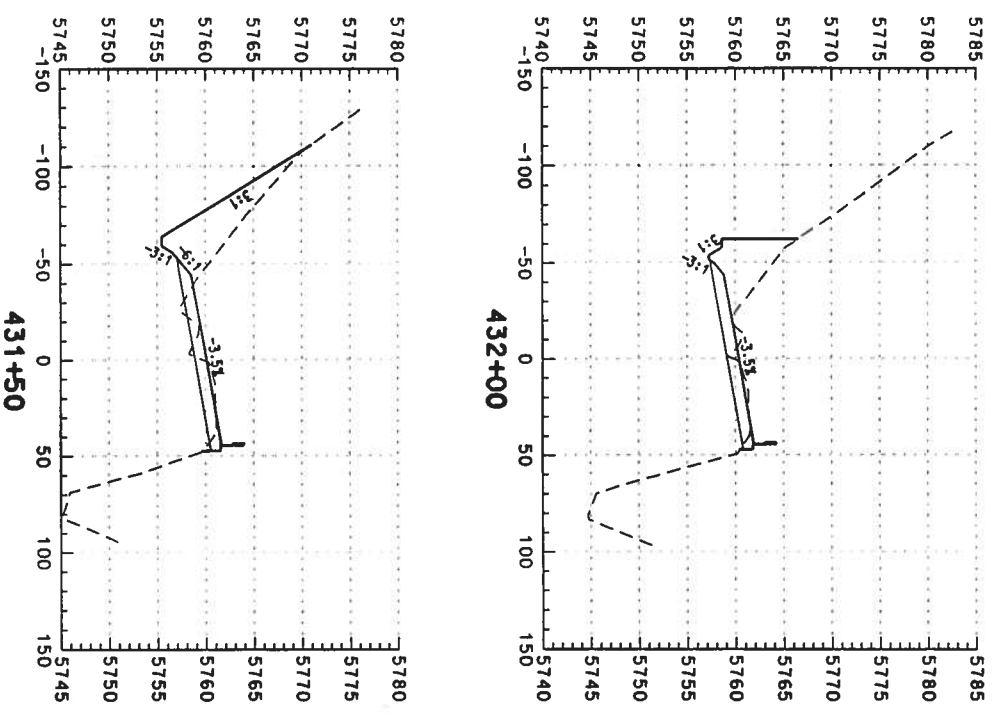

Computer File Information
 Creation Date: 02/14/03 Initials: DAF
 Last Modification Date: Initials:
 Full Path: S:\Trampro\246042\2\HywDes\Plans\
 Drawing File Name: rdxs-so-2d090.dgn
 Scale: Units: ENGLISH

Index of Revisions

DOT
 DIVISION OF TRANSPORTATION
 339 Inverness Dr. South
 Suite K
 Englewood, CO 80112
 Phone: (303) 790-1020
 FAX: (303) 790-1037

PBSJ
 5500 Greenwood Plaza Blvd.
 Suite 150
 Greenwood Village, CO 80111
 Phone: 303/221-7275
 Fax: 303/221/7276

As Constructed

No. Revisions:	
Revised:	
Void:	

US 85 CROSS SECTIONS

Designer: DAF
 Detailer: DAF
 Sheet Subset: Roadway
 Structure Numbers: of
 Subset Sheets: of

Project No./Code
 NH 0852-086
 13429
 Sheet Number: 389

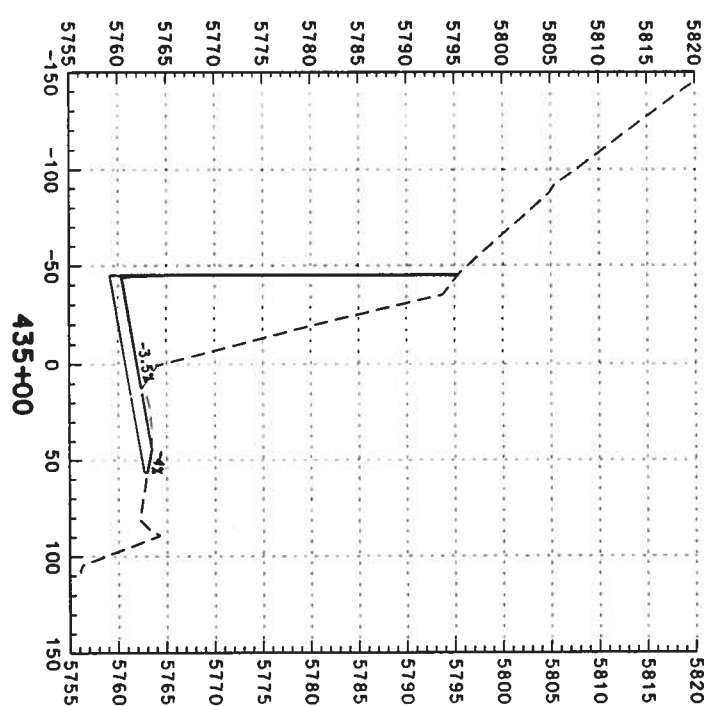
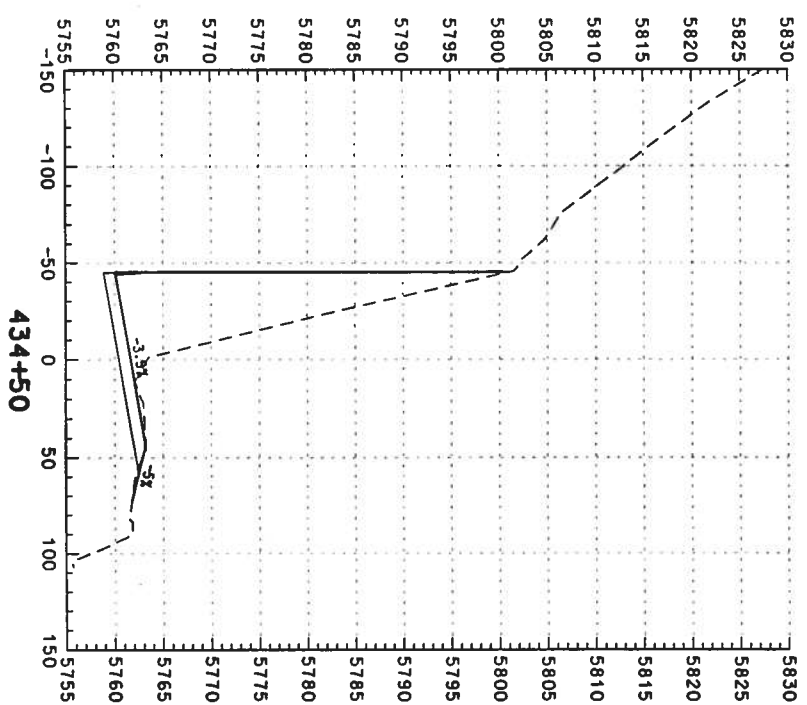
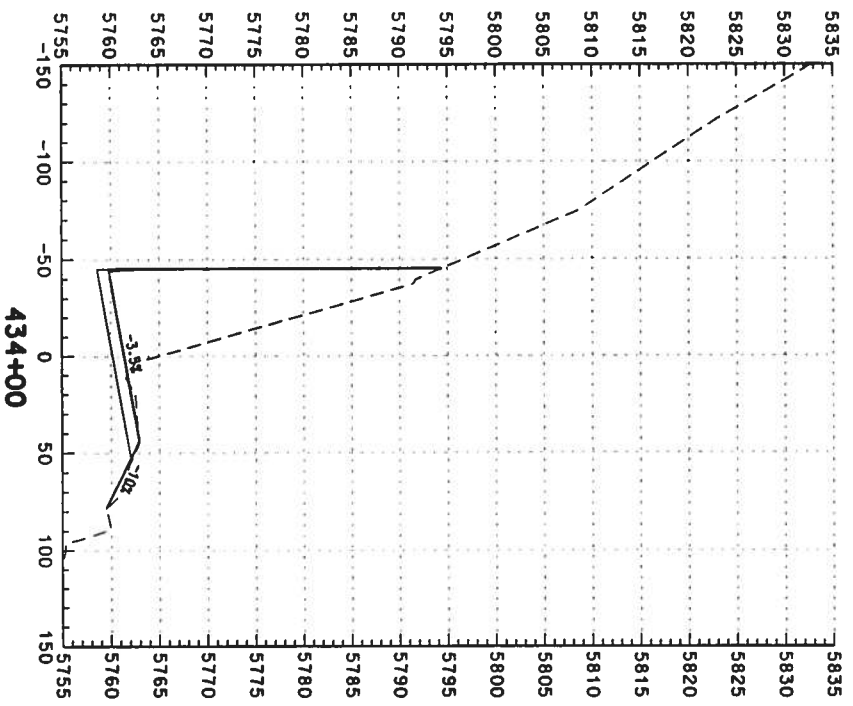

Computer File Information

Creation Date: 02/14/03 Initials: DAF
 Lost Modification Date: Initials:
 Full Path: S:\Tranpro\246042\HwyDes\Plans\
 Drawing File Name: rdxs-so-20091.dgn
 Scale: Units: ENGLISH

Index of Revisions

No.	Description	Date	Initials



359 Inverness Dr. South
 Suite K
 Englewood, CO 80112
 Phone: (303) 790-1020
 Fax: (303) 790-1037

REGION 1



5500 Greenwood Plaza Blvd.
 Suite 150
 Greenwood Village, CO 80111
 Phone: 303/221-7275
 Fax: 303/221/7276

As Constructed

No. Revisions:
 Revised:
 Void:

US 85 CROSS SECTIONS

Designer: DAF
 Detailer: DAF
 Sheet Subset: Roadway
 Subset Sheets: of

Project No./Code

NH 0852-086
 13429
 Sheet Number: 390

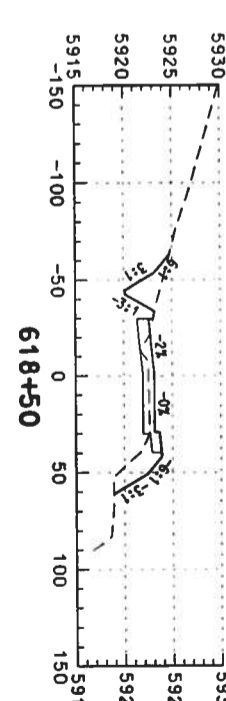
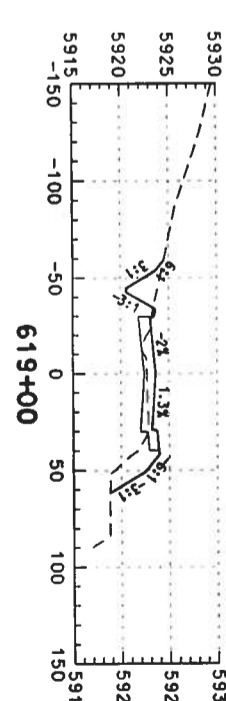
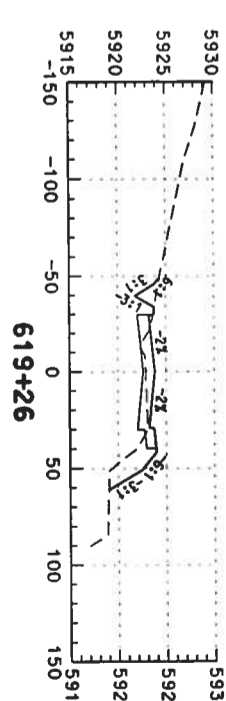
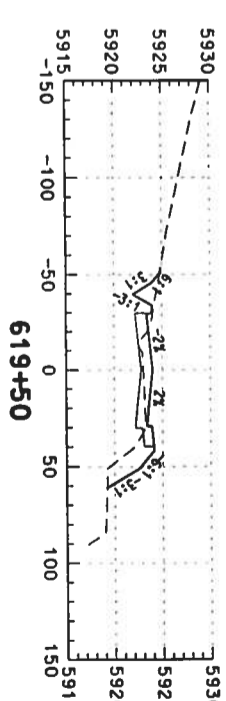
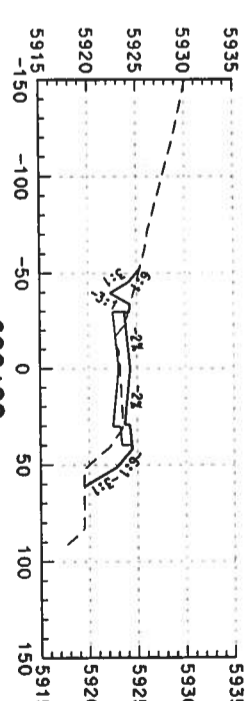
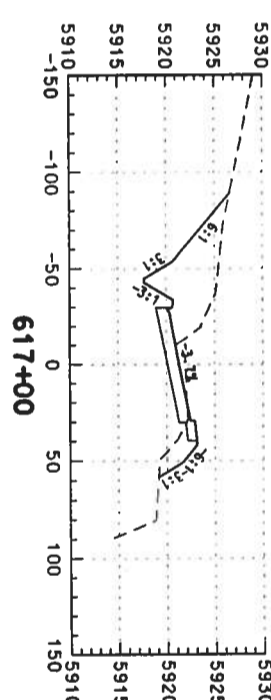
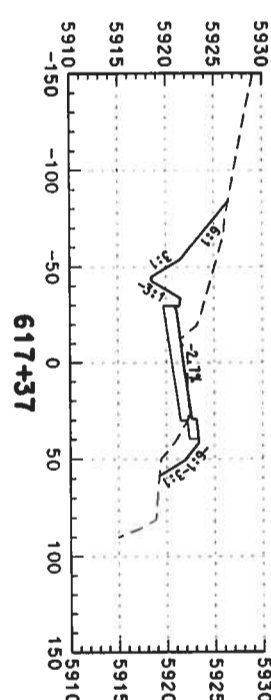
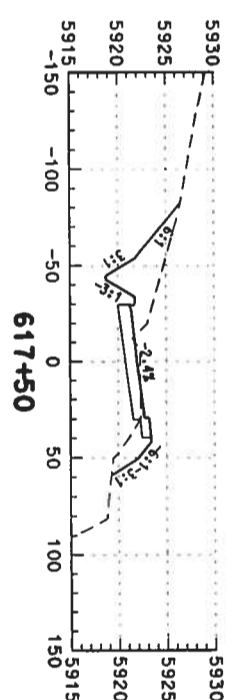
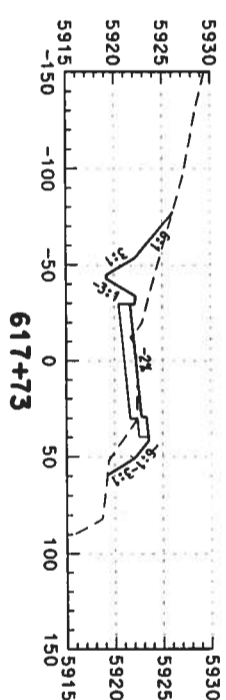
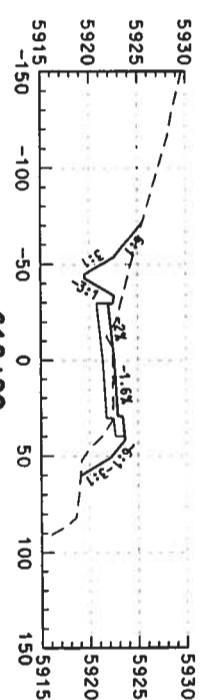
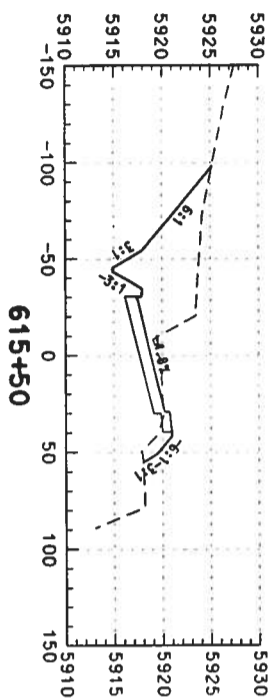
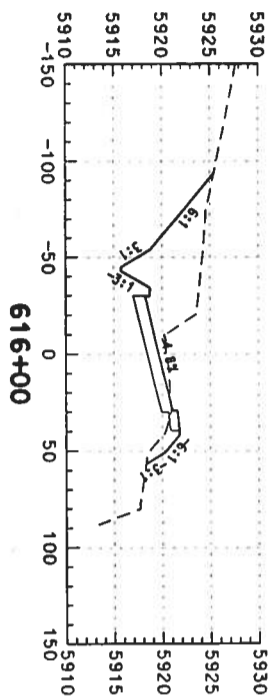
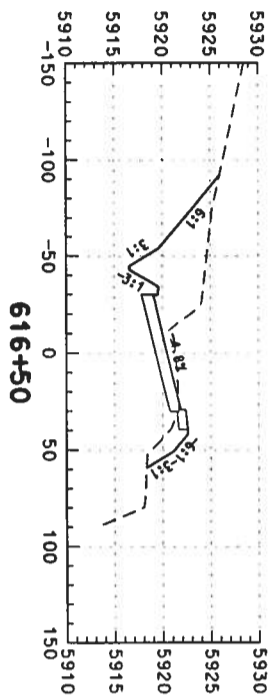
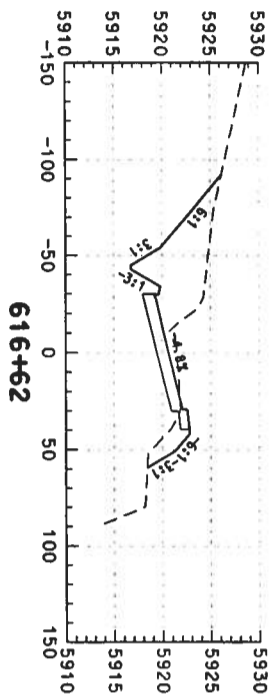

Computer File Information

Creation Date: 02/14/03 Initials: DAF
 Last Modification Date: Initials:
 Full Path: S:\Transport\246042\246042\HwyDes\Plans\
 Drawing File Name: rdxs-so-2dt27.dgn
 Scale: Units: ENGLISH

Index of Revisions



359 Inverness Dr. South
 Suite K
 Englewood, CO 80112
 Phone: (303) 790-1020
 Fax: (303) 790-1037

REGION 1



5500 Greenwood Plaza Blvd.
 Suite 150
 Greenwood Village, CO 80111
 Phone: 303/721-7275
 Fax: 303/721/7276

As Constructed

No. Revisions:
 Revised:
 Void:

US 85 CROSS SECTIONS

Designer: DAF
 Detailer: DAF
 Sheet Subset: Roadway
 Structure Numbers:
 Subset Sheets: of

Project No./Cod

NH 0852-086
 13429
 Sheet Number: 426

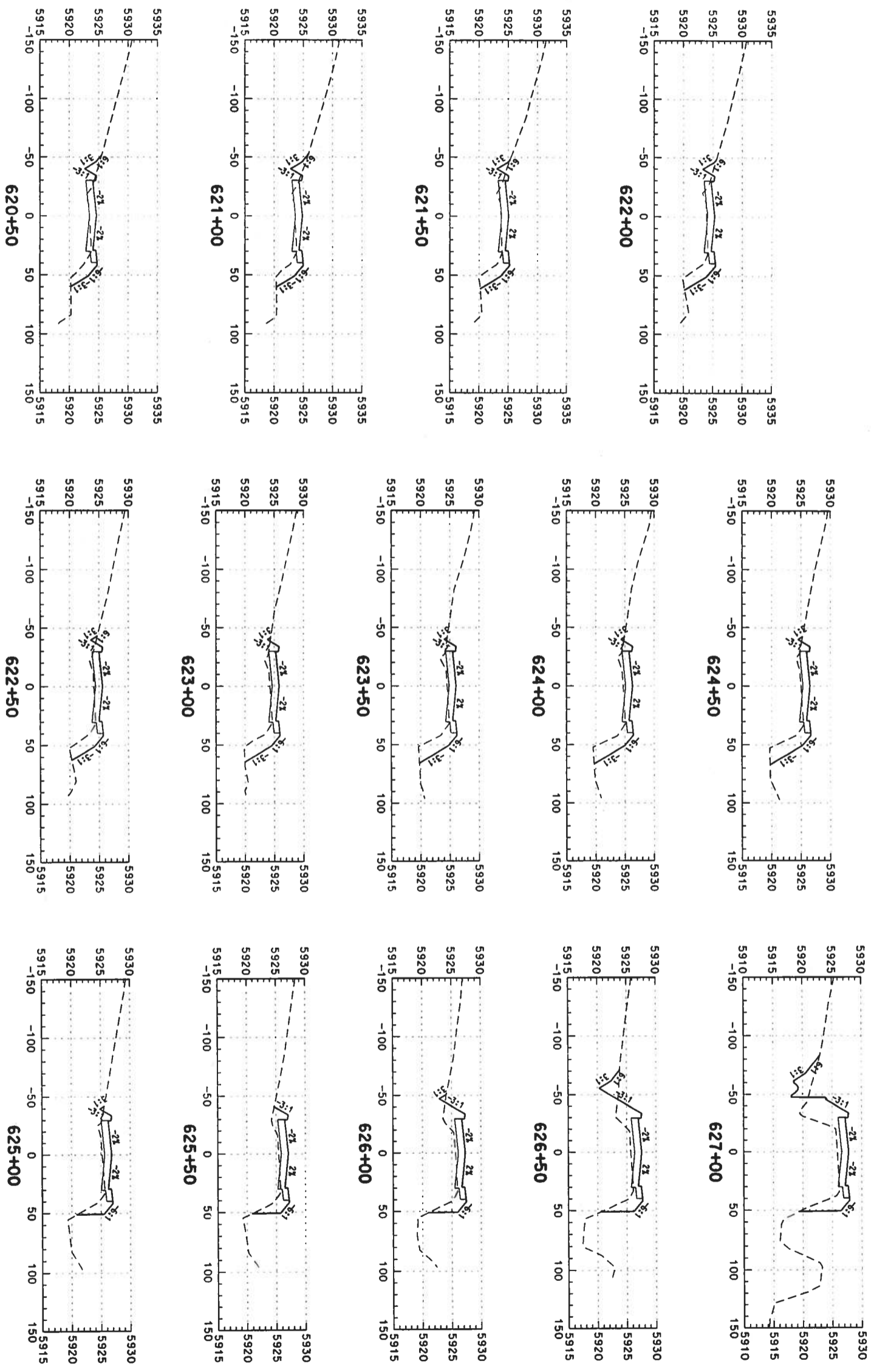

Computer File Information

Creation Date: 02/14/03 Initials: DAF
 Last Modification Date: Initials:
 Full Path: S:\Transport\246042.12\HW\Des\Plans\
 Drawing File Name: rdxs-so-2d128.dgn
 Scale: Units: ENGLISH

Index of Revisions

DOT
 DEPARTMENT OF TRANSPORTATION
 359 Inverness Dr. South
 Suite K
 Englewood, CO 80112
 Phone: (303) 790-1020
 FAX: (303) 790-1037

PBSJ
 5500 Greenwood Plaza Blvd.
 Suite 150
 Greenwood Village, CO 80111
 Phone: 303/221-7275
 Fax: 303/221-7276

As Constructed

No. Revisions:	
Revised:	
Void:	

US 85 CROSS SECTIONS

Designer:	DAF	Structure	
Detailer:	DAF	Numbers	
Sheet Subset:	Roadway	Subset Sheets:	
		of	

Project No./Cod

NH 0852-086
 13429
 Sheet Number: 42

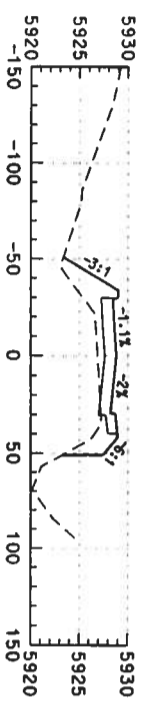

629+00

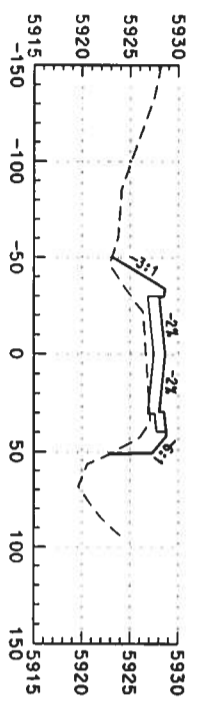

628+67

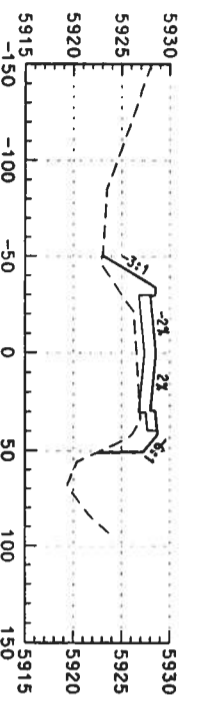

628+50

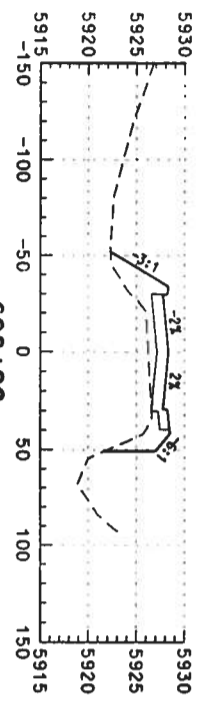

628+00

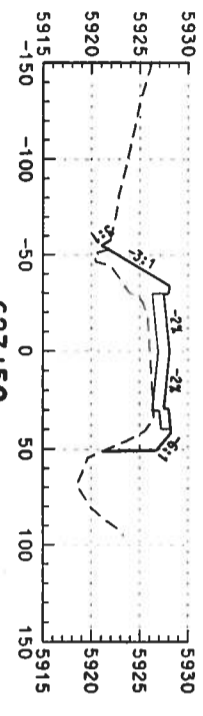

627+50

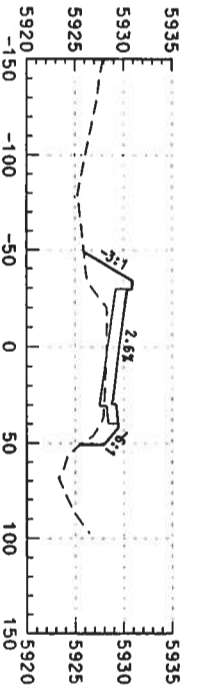

630+50

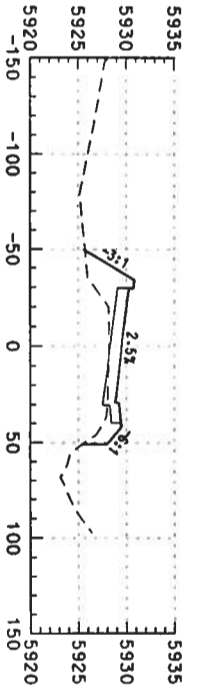

630+43

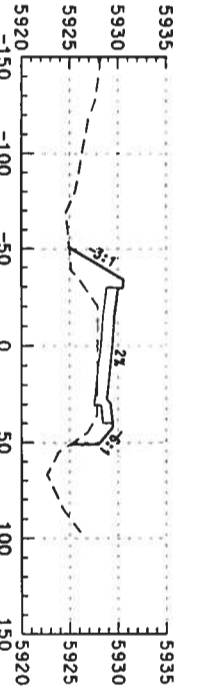

630+21

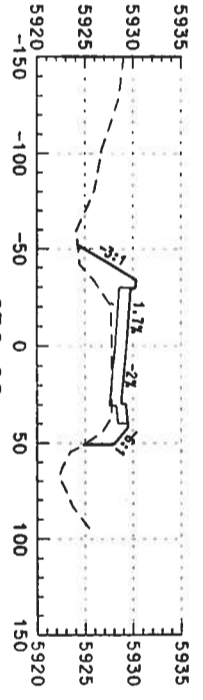

630+00

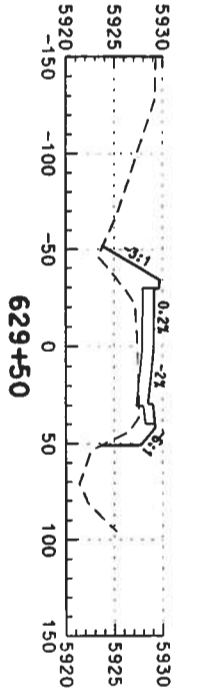

629+50

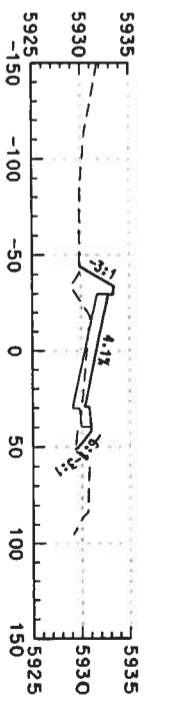

633+00

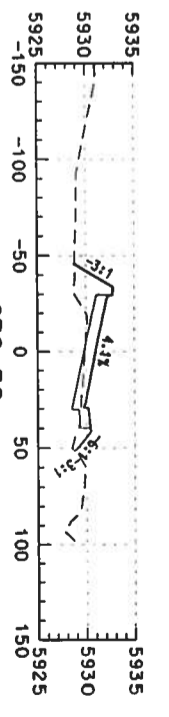

632+50

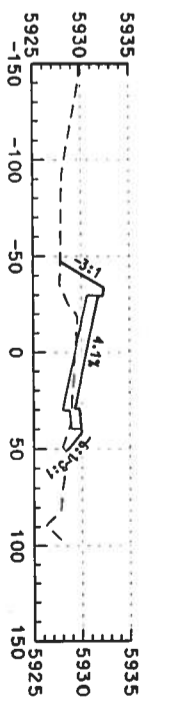

632+00

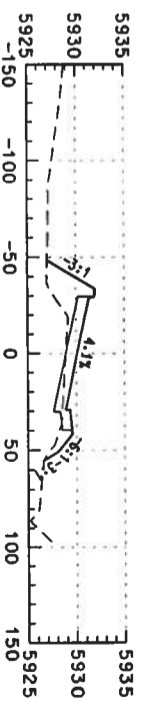

631+50

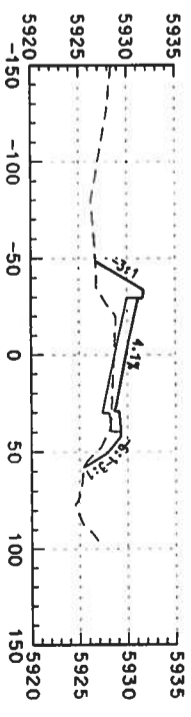

631+09

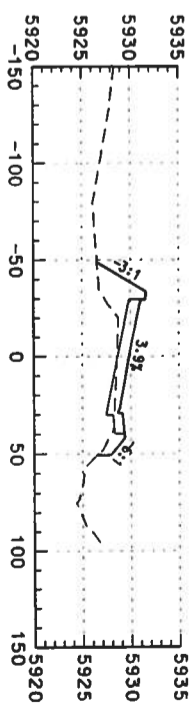

631+00

Computer File Information

Creation Date: 02/14/03 Initials: DAF
 Last Modification Date: Initials:
 Full Path: S:\Tranproj\246042\HwyDes\Plans\
 Drawing File Name: rdks-so-2d129.dgn
 Scale: Units: ENGLISH

Index of Revisions



DOT
DEPARTMENT OF TRANSPORTATION



PBSJ

359 Inverness Dr. South
 Suite K
 Englewood, CO 80112
 Phone: (303) 790-1020
 Fax: (303) 790-1037

5500 Greenwood Plaza Blvd
 Suite 150
 Greenwood Village, CO 80111
 Phone: 303/221-7275
 Fax: 303/221/7276

REGION 1

As Constructed

No. Revisions:
 Revised:
 Void:

US 85 CROSS SECTIONS

Designer: DAF
 Detailer: DAF
 Sheet Subset: Roadway
 Subsets: _____ of _____

Project No./Cod

NH 0852-086
 13429
 Sheet Number: 428

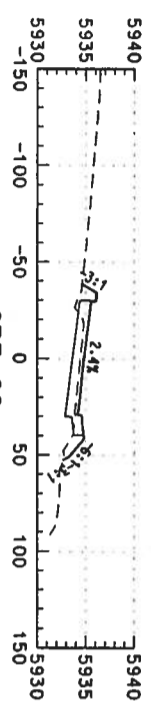

633+50

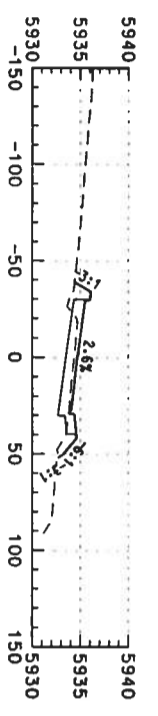

634+00

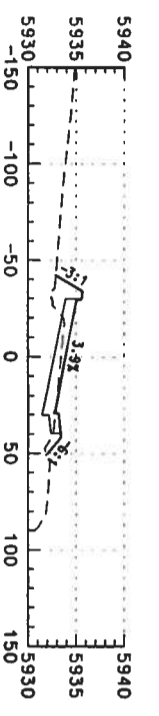

634+42

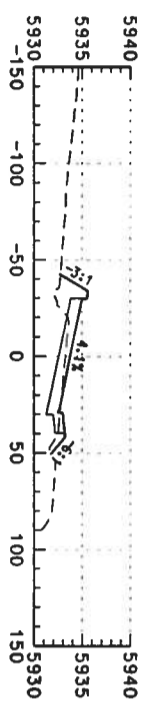

634+50

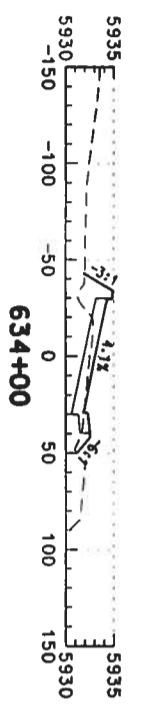

635+00

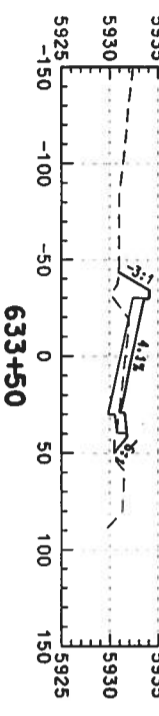

635+50

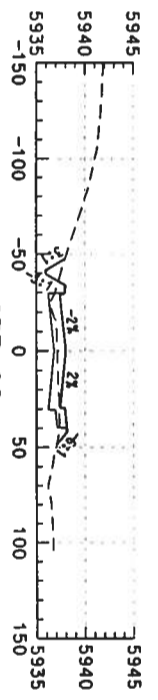

635+30

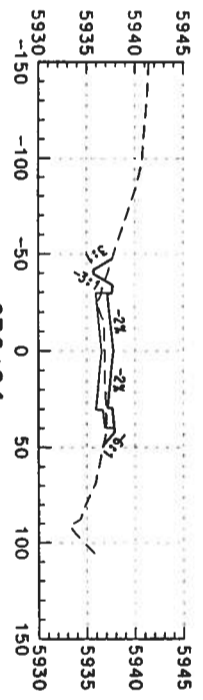

636+00

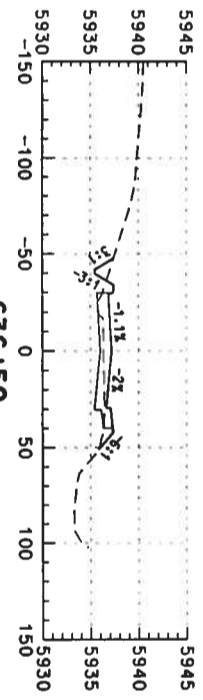

636+50

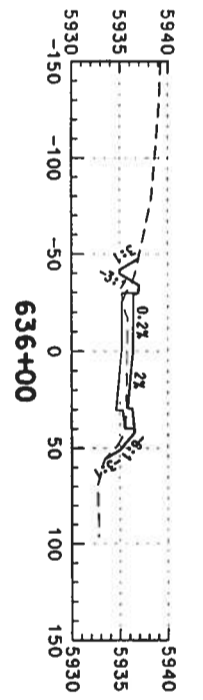

636+84

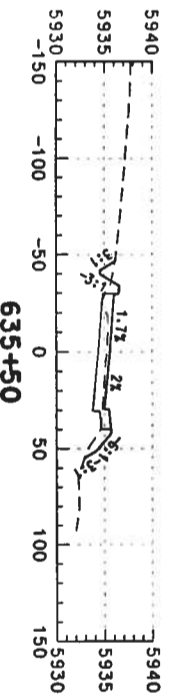

637+00

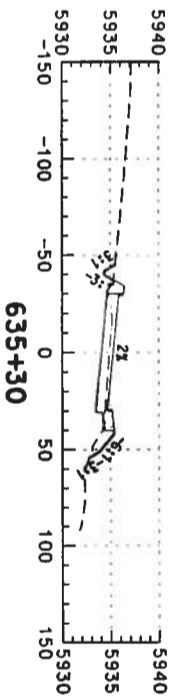

637+50

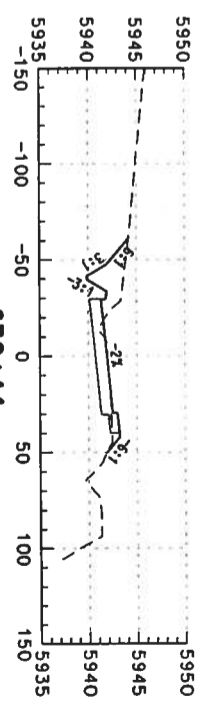

638+00

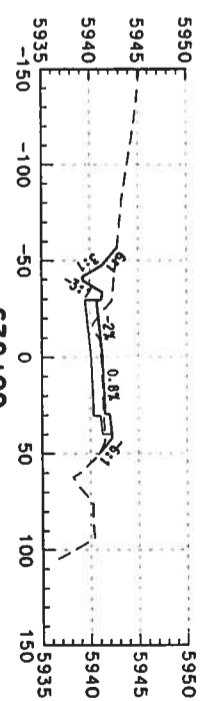

638+50

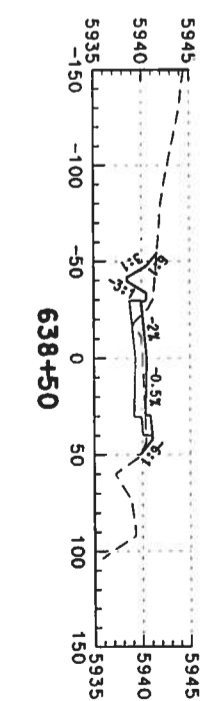

639+00

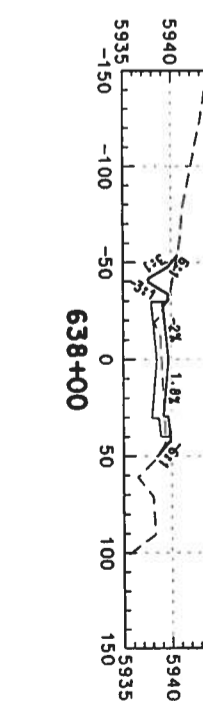

639+44

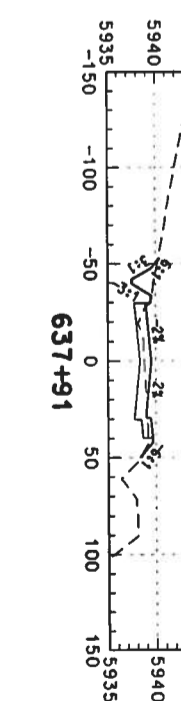

639+50

Computer File Information

Creation Date: 02/14/03
 Last Modification Date:
 Full Path: S:\Transport\246042\2\HW\Des\Plans\
 Drawing File Name: rdxs-so-2d130.dgn
 Scale: Units: ENGLISH

Index of Revisions

Initials:	Date:	Description:
DAF		



359 Inverness Dr. South
 Suite K
 Englewood, CO 80112
 Phone: (303) 790-1020
 FAX: (303) 790-1037



5500 Greenwood Plaza Blvd.
 Suite 150
 Greenwood Village, CO 80111
 Phone: 303/221-7275
 Fax: 303/221/7276

As Constructed

No. Revisions:
 Revised:
 Void:

US 85 CROSS SECTIONS

Designer: DAF
 Detailer: DAF
 Sheet Subset: Roadway of

Project No./Cod

NH 0852-086
 13429
 Sheet Number: 42

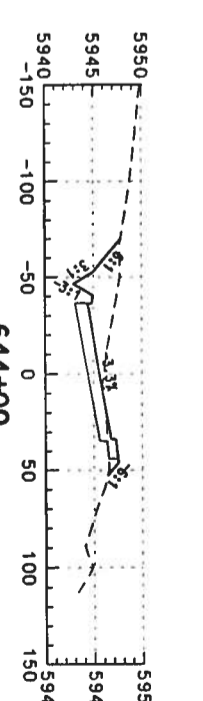
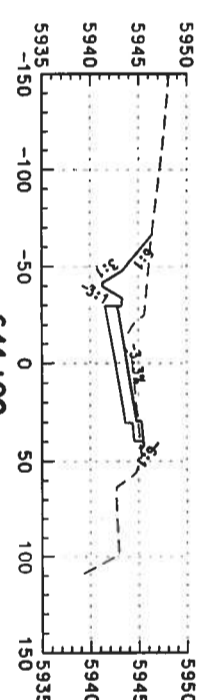
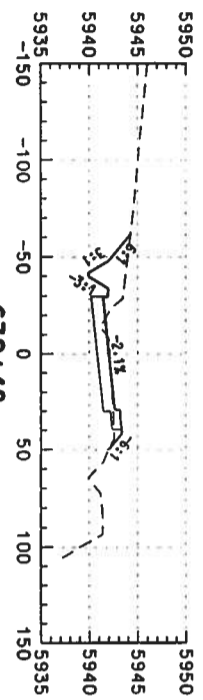
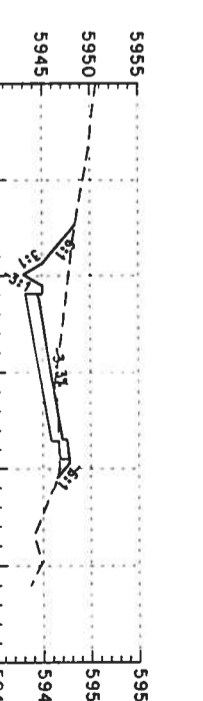
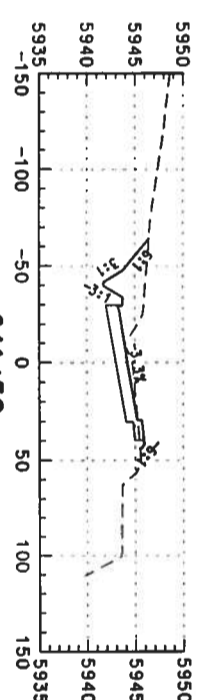
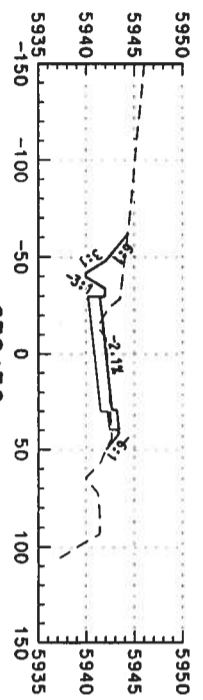
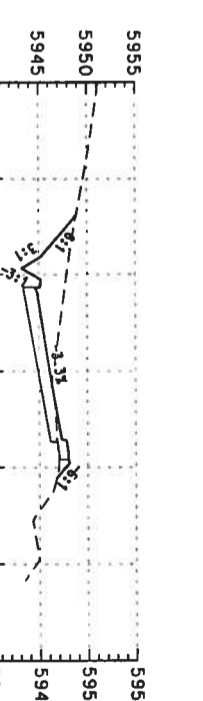
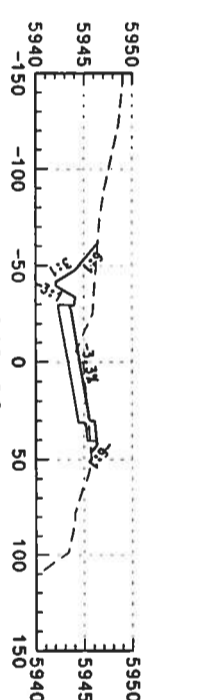
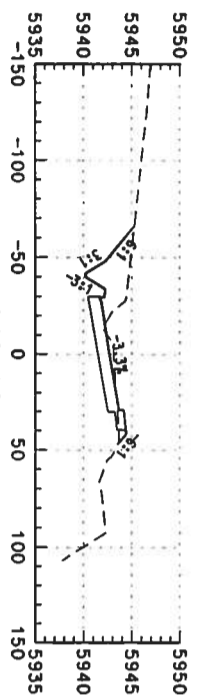
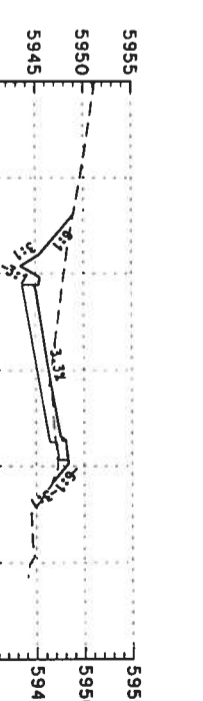
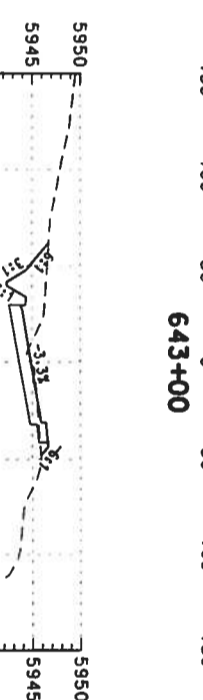
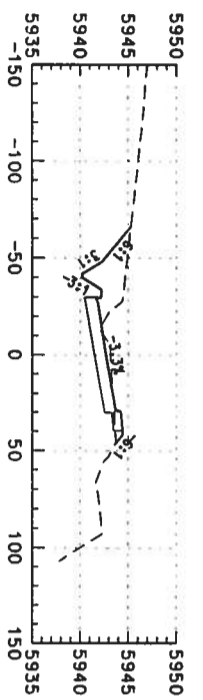
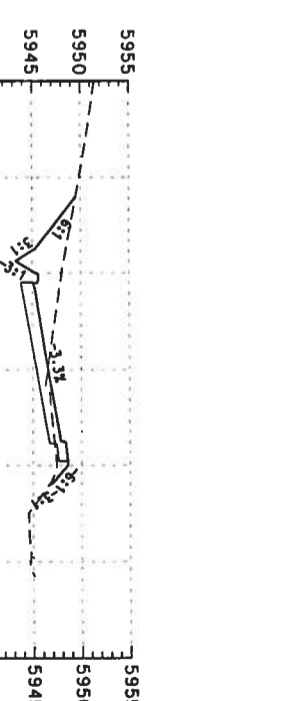
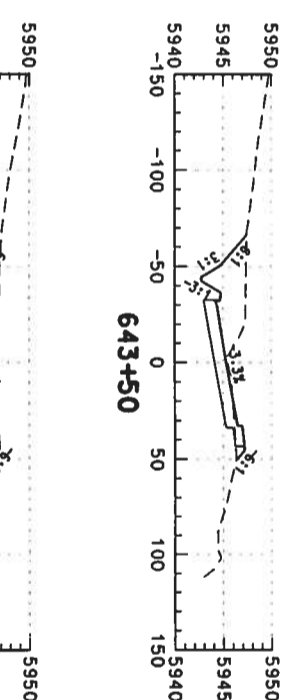
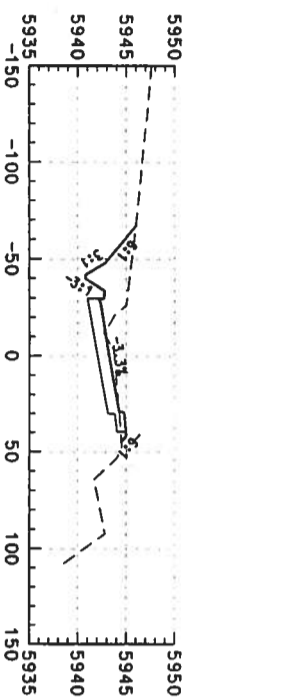

Computer File Information

Creation Date: 02/14/03 Initials: DAF
 Last Modification Date: Initials:
 Full Path: S:\Tranpro\246042.12\HwyDes\Plans\
 Drawing File Name: rdxs-so-2d131.dgn
 Scale: Units: ENGLISH

Index of Revisions



DOT
DEPARTMENT OF TRANSPORTATION

REGION 1

359 Inverness Dr. South
 Suite K
 Englewood, CO 80112
 Phone: (303) 790-1020
 Fax: (303) 790-1037

PBS&J
 5500 Greenwood Plaza Blvd.
 Suite 150
 Greenwood Village, CO 80111
 Phone: 303/221-7275
 Fax: 303/221/7276

As Constructed

No. Revisions:
 Revised:
 Void:

US 85 CROSS SECTIONS

Designer: DAF
 Detailer: DAF
 Sheet Subset: Roadway
 Subst Sheets: of

Project No./Cod

NH 0852-086
 13429
 Sheet Number: 432

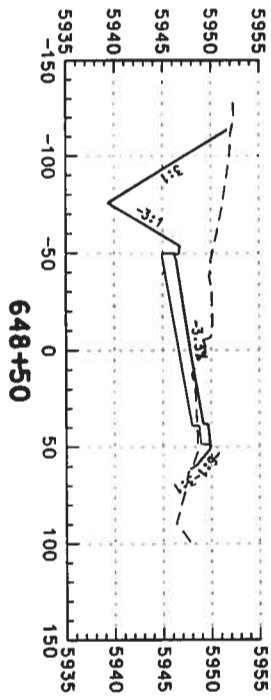
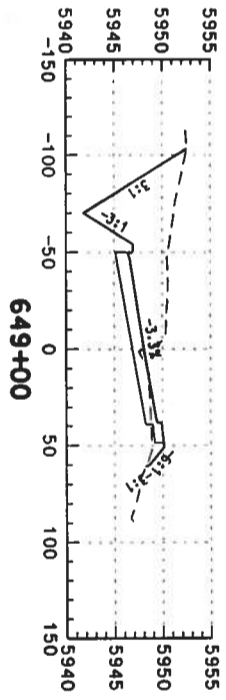
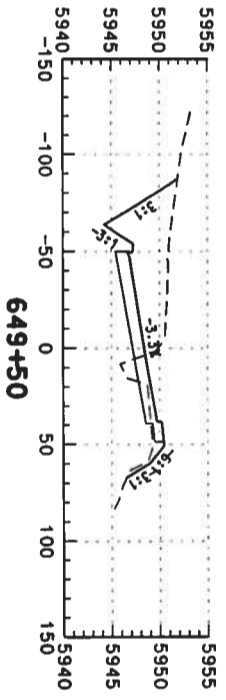
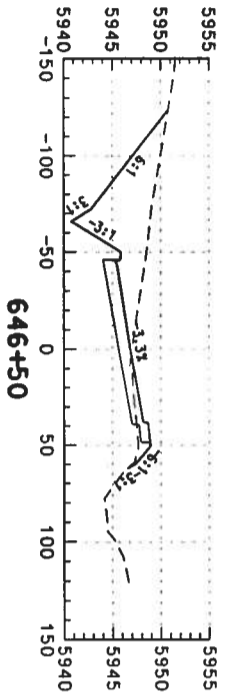
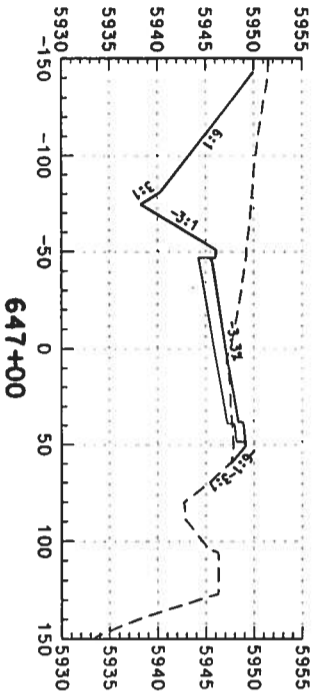
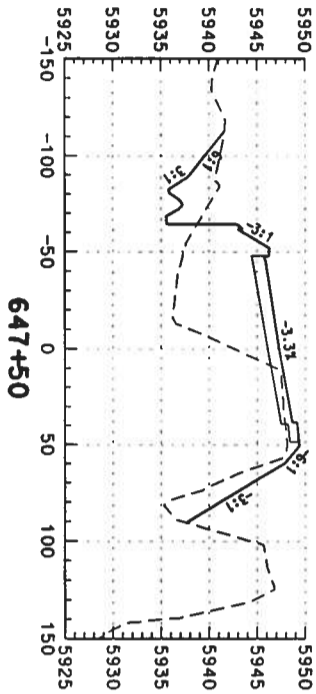
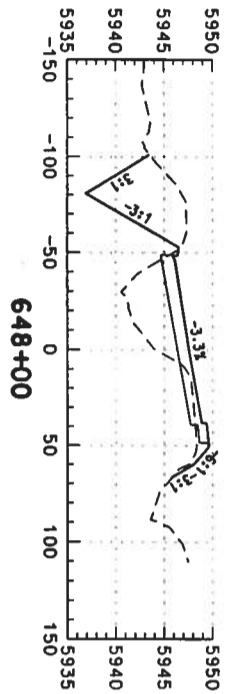

Computer File Information

Creation Date: 02/14/03 Initials: DAF
 Last Modification Date: Initials:
 Full Path: S:\Tranpro\246042.12\HwyDes\Plans\
 Drawing File Name: rdxs-so-24132.dgn
 Scale: Units: ENGLISH

Index of Revisions



REGION 1

359 Inverness Dr. South
 Suite K
 Englewood, CO 80112
 Phone: (303) 790-1020
 Fax: (303) 790-1037



5500 Greenwood Plaza Blvd.
 Suite 150
 Greenwood Village, CO 80111
 Phone: 303/221-7275
 Fax: 303/221/7276

As Constructed

No. Revisions:	
Revised:	
Void:	

US 85 CROSS SECTIONS

Designer: DAF Structure Numbers:
 Detailer: DAF Subsets:
 Sheet Subset: Roadway of

Project No./Cod

NH 0852-086
 13429
 Sheet Number: 431

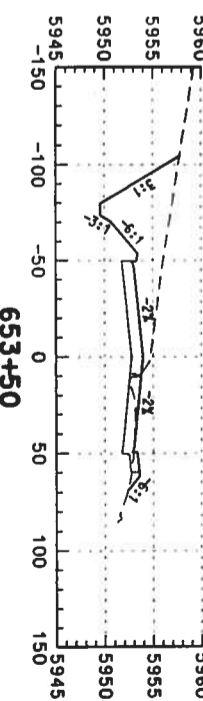
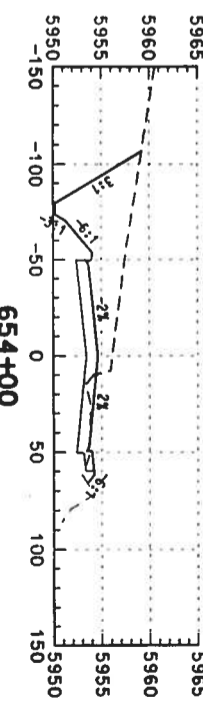
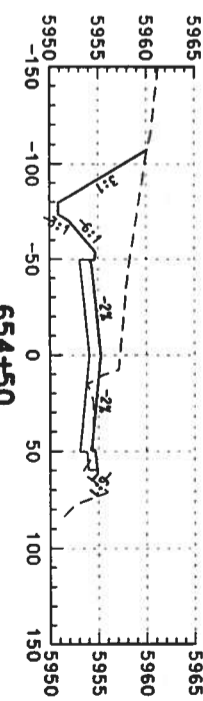
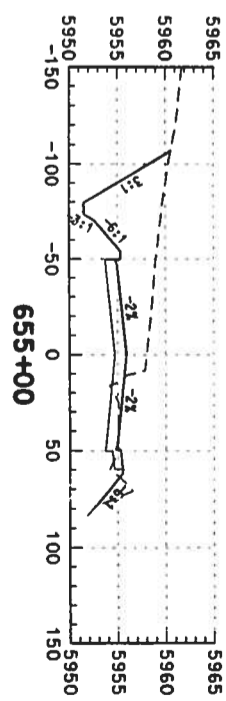
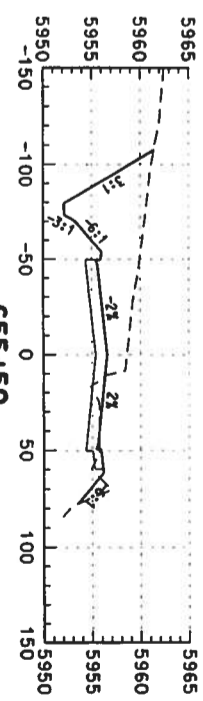
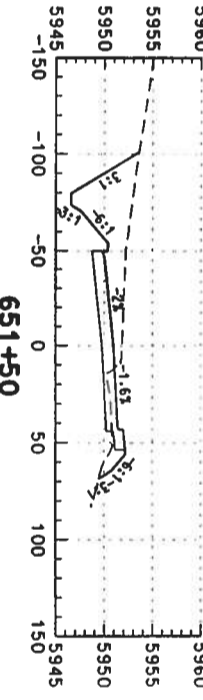
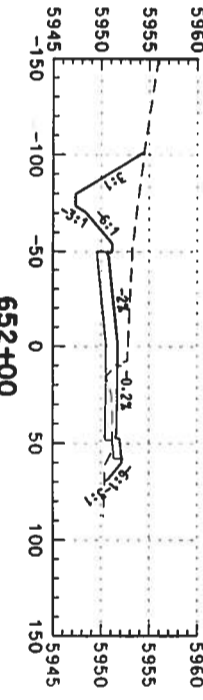
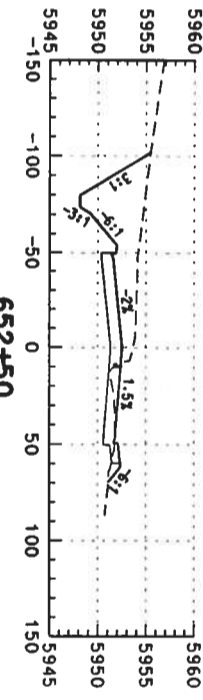
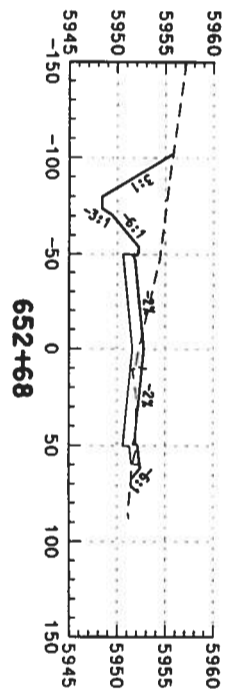
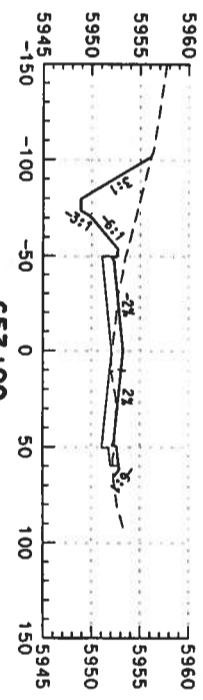
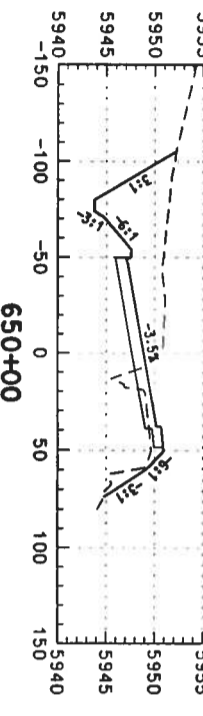
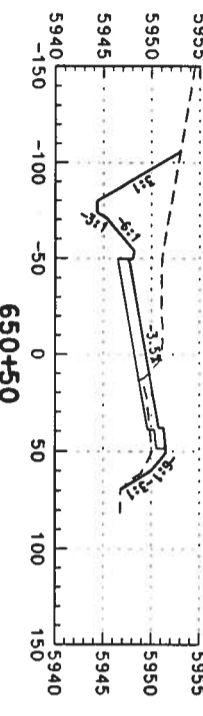
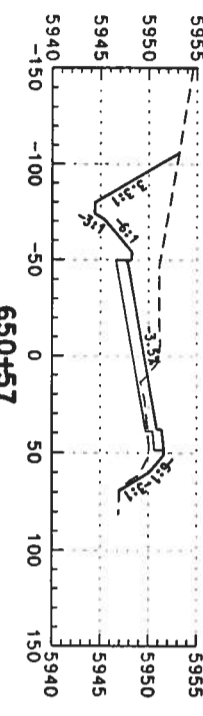
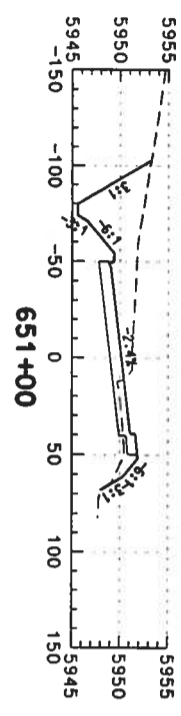
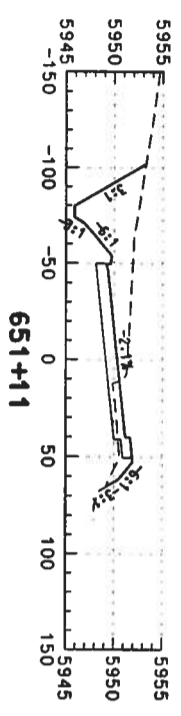
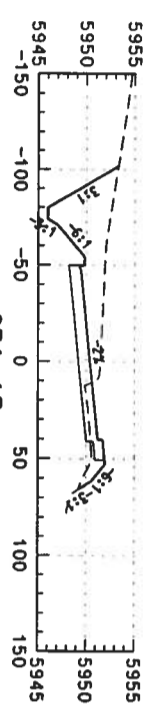

Computer File Information

Creation Date: 02/14/03
 Last Modification Date: 02/14/03
 Full Path: S:\Tranproj\246042.12\HwyDes\Plans\
 Drawing File Name: rdxs-so-2d133.dgn
 Scale: Units: ENGLISH

Index of Revisions



359 Riverbess Dr. South
 Suite K
 Englewood, CO 80112
 Phone: (303) 790-1020
 Fax: (303) 790-1037



5500 Greenwood Plaza Blvd.
 Suite 150
 Greenwood Village, CO 80111
 Phone: 303/221-7275
 Fax: 303/221-7276

REGION 1

As Constructed

No. Revisions:
 Revised:
 Void:

US 85 CROSS SECTIONS

Designer: DAF
 Detailer: DAF
 Sheet Subset: Roadway
 Subsets:
 of

Project No./Cod

NH 0852-086
 13429
 Sheet Number: 432

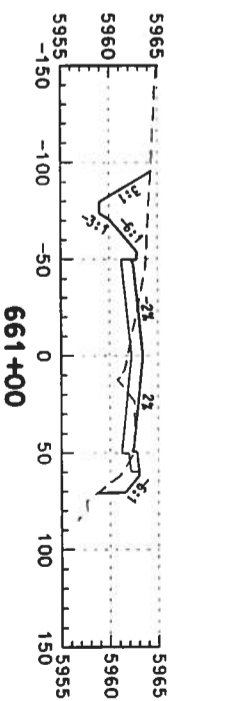
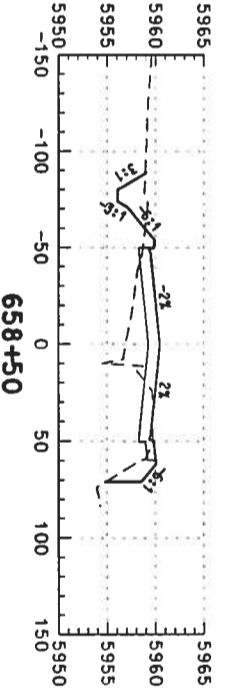
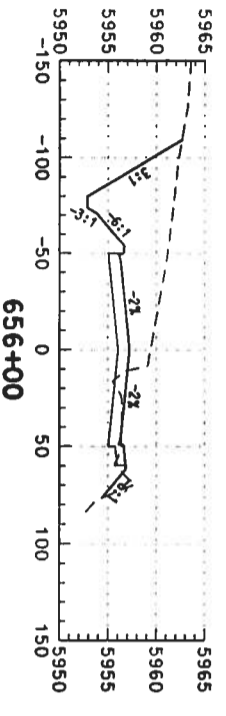
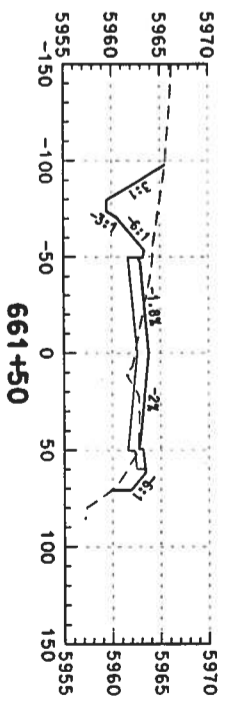
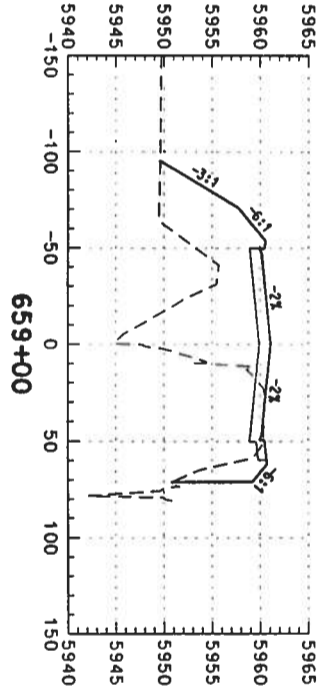
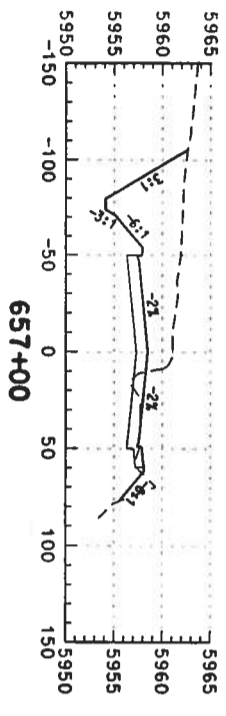
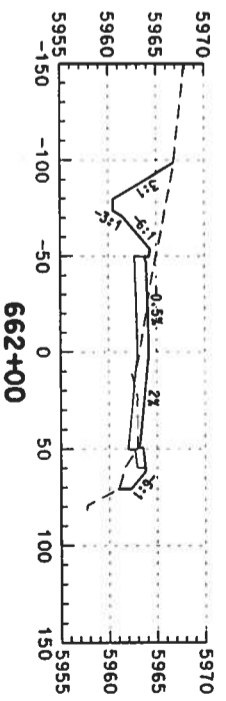
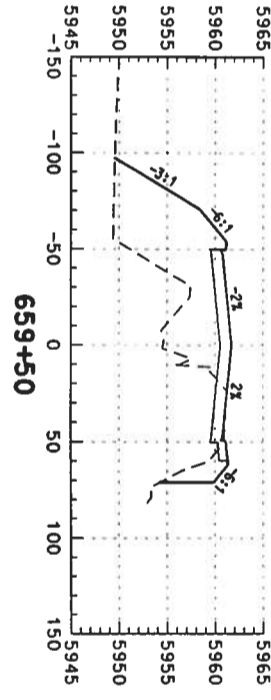
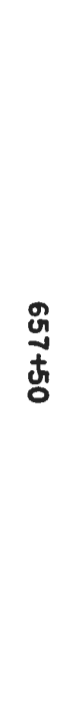
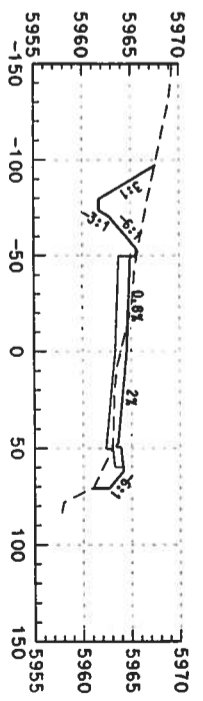
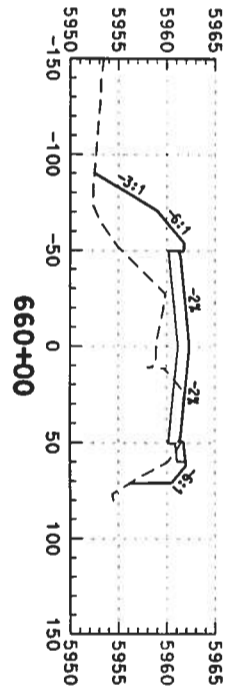
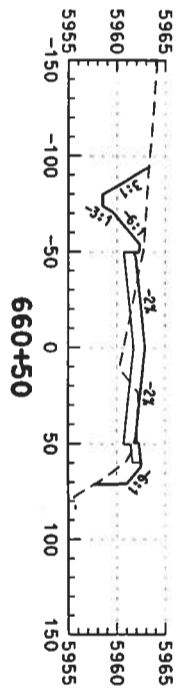
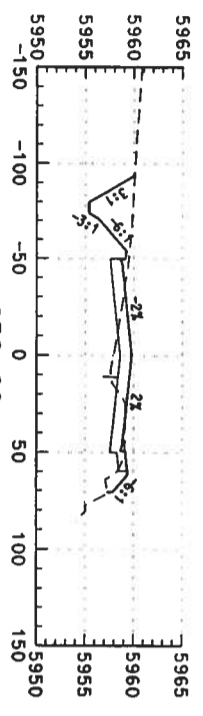

Computer File Information

Creation Date: 02/14/03 Initials: DAF
 Last Modification Date: Initials:
 Full Path: S:\Trompro\246042\2\HydDes\Plans\
 Drawing File Name: rdxs-so-2d134.dgn
 Scale: Units: ENGLISH

Index of Revisions



358 Inverness Dr. South
 Suite K
 Englewood, CO 80112
 Phone: (303) 790-1020
 Fax: (303) 790-1037



5500 Greenwood Plaza Blvd.
 Suite 150
 Greenwood Village, CO 80111
 Phone: 303/221-7275
 Fax: 303/221/7276

REGION I

As Constructed

No. Revisions:
 Revised:
 Void:

US 85 CROSS SECTIONS

Designer: DAF
 Detailer: DAF
 Sheet Subset: Roadway
 Subset Sheets: of

Project No./Code

NH 0852-086
 13429
 Sheet Number: 433

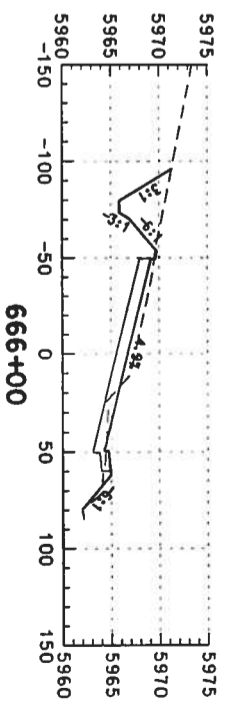
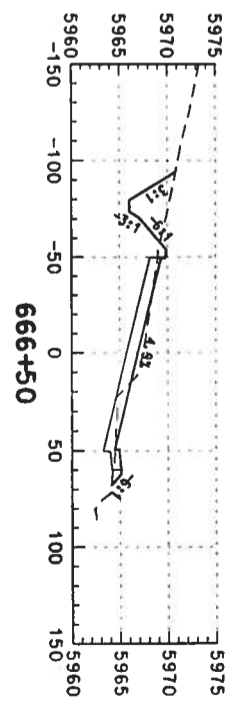
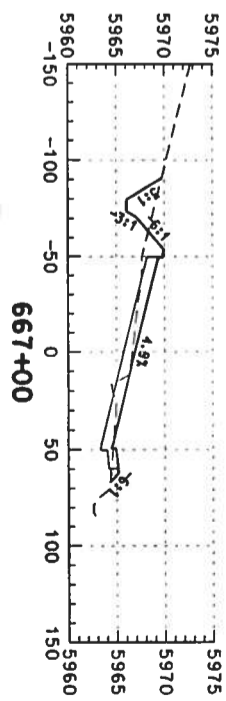
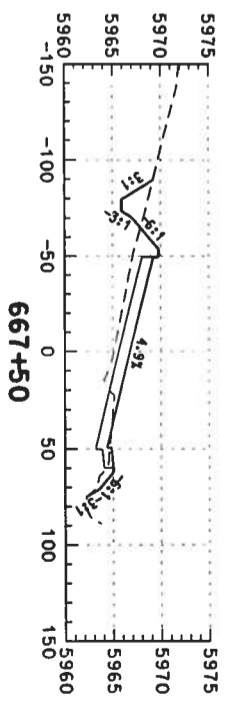
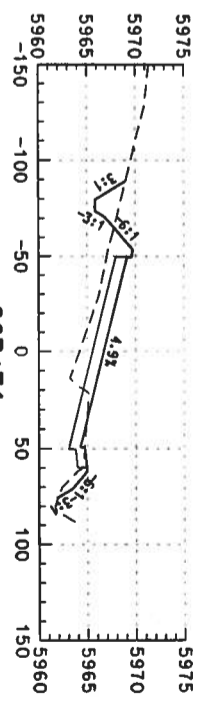
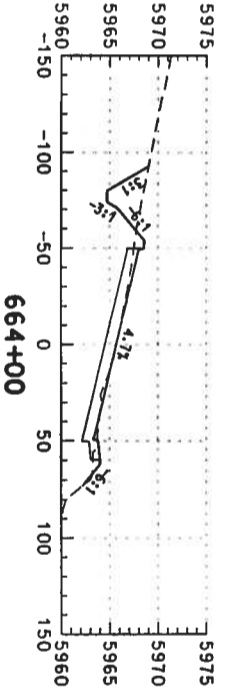
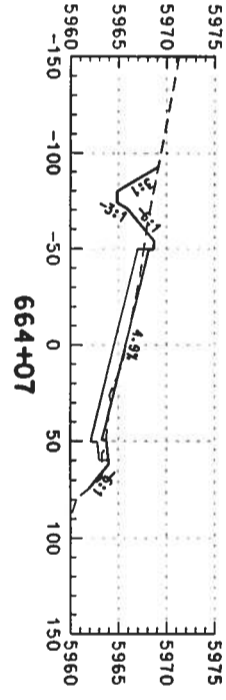
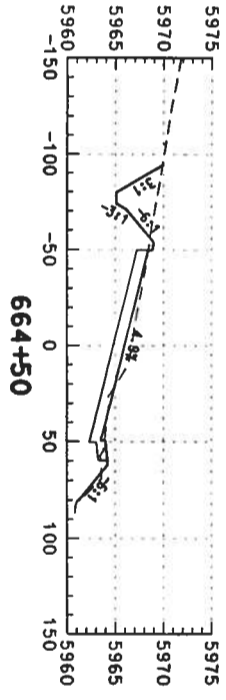
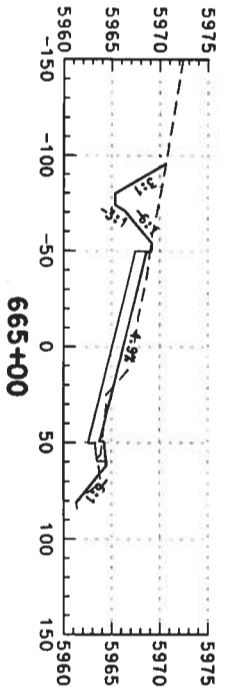
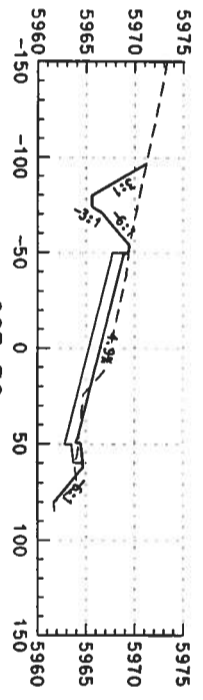
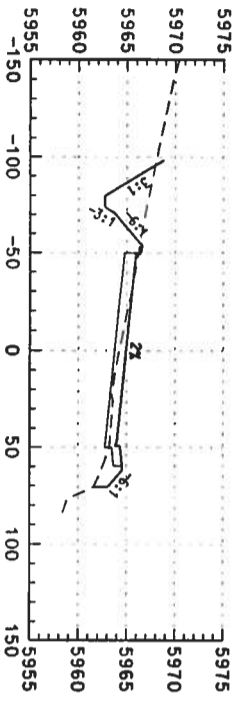
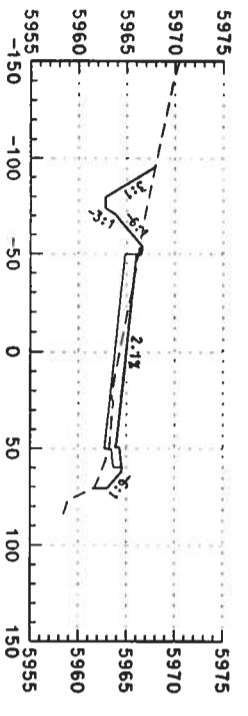
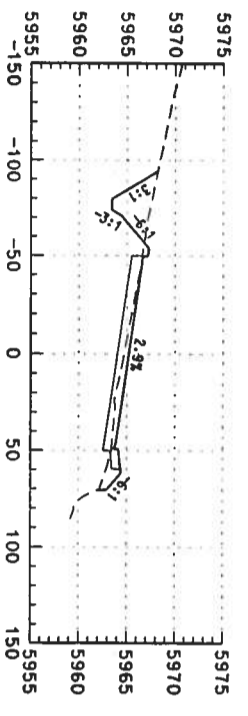
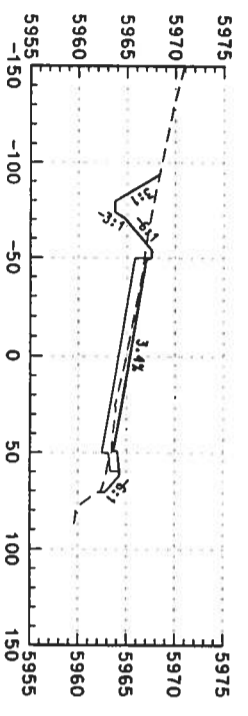

Computer File Information

Creation Date: 02/14/03 Initials: DAF
 Lost Modification Date: Initials:
 Full Path: S:\Trompro\246042\Hydres\Plans\
 Drawing File Name: rdxs-so-2d135.dgn
 Scale: Units: ENGLISH

Index of Revisions



358 Inverness Dr. South
 Suite K
 Englewood, CO 80112
 Phone: (303) 790-1020
 Fax: (303) 790-1037

REGION 1



5500 Greenwood Plaza Blvd.
 Suite 150
 Greenwood Village, CO 80111
 Phone: 303/221-7275
 Fax: 303/221/7276

As Constructed

No. Revisions:
 Revised:
 Void:

US 85 CROSS SECTIONS

Designer: DAF
 Detailer: DAF
 Sheet Subset: Roadway
 Subsheet Numbers:
 of

Project No./Code

NH 0852-086
 13429
 Sheet Number: 434

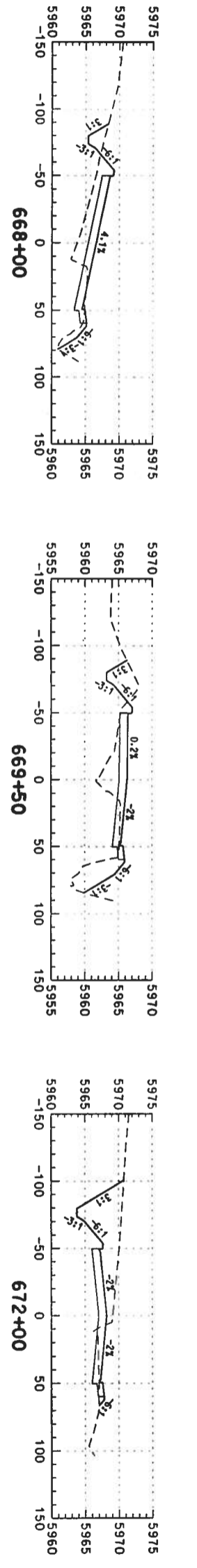
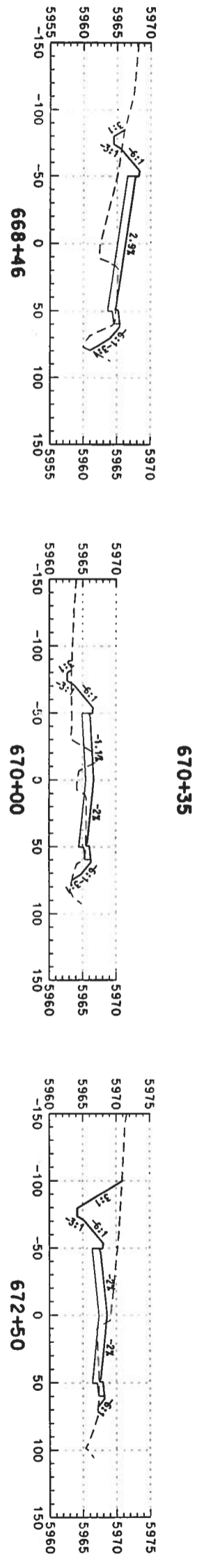
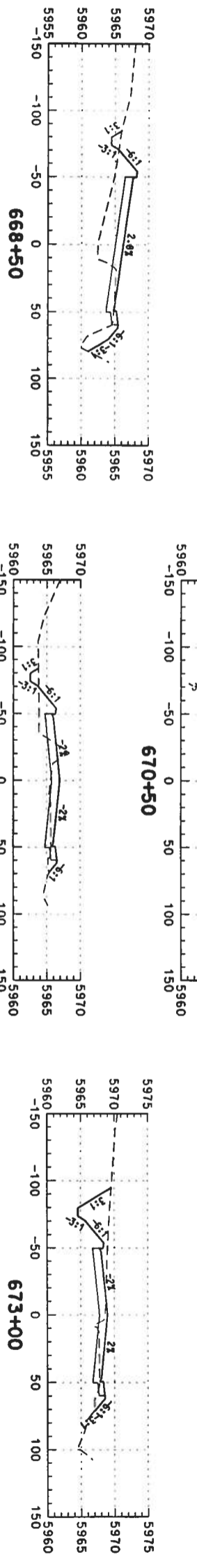
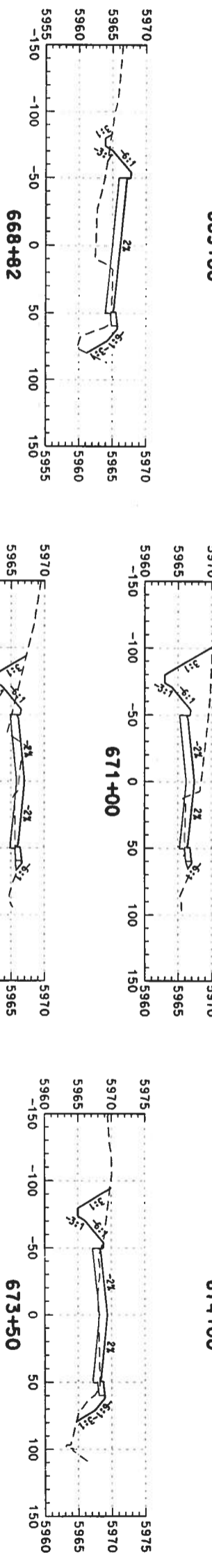
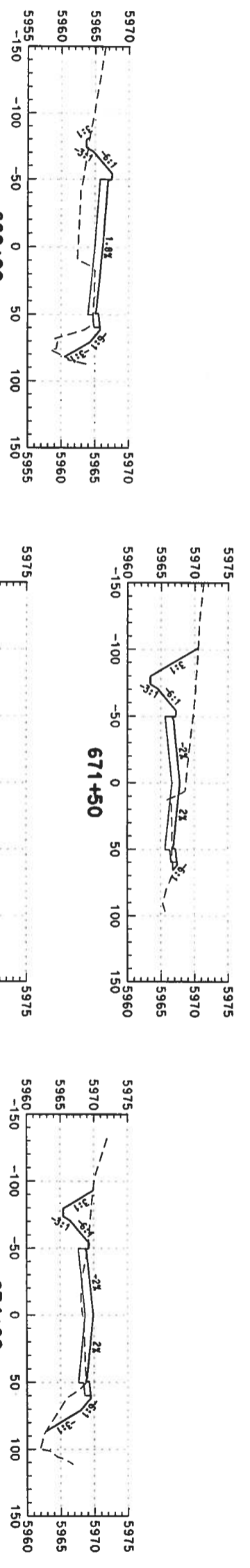

Computer File Information

Creation Date: 02/14/03 Initials: DAF
 Lost Modification Date: Initials:
 Full Path: S:\Itrproj\246042\2\Hydres\Plans\
 Drawing File Name: rdx-so-2d136.dgn
 Scale: Units: ENGLISH

Index of Revisions



359 Inverness Dr. South
 Suite K
 Englewood, CO 80122
 Phone: (303) 790-1020
 Fax: (303) 790-1037

REGION 1



5500 Greenwood Plaza Blvd.
 Suite 150
 Greenwood Village, CO 80111
 Phone: 303/221-7275
 Fax: 303/221-7276

As Constructed

No. Revisions:
 Revised:
 Void:

US 85 CROSS SECTIONS

Designer: DAF
 Detailer: DAF
 Sheet Subset: Roadway
 Subsets: _____ of _____

Project No./Code

NH 0852-086
 13429
 Sheet Number: 435

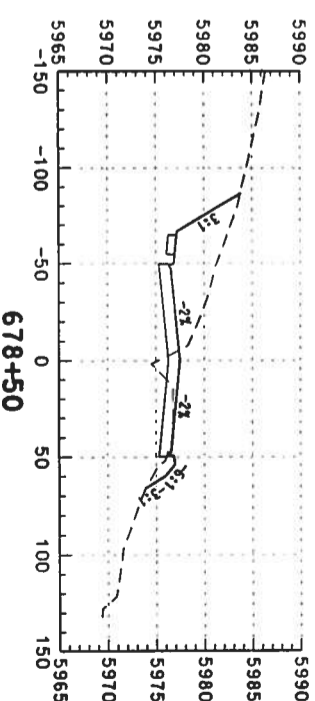
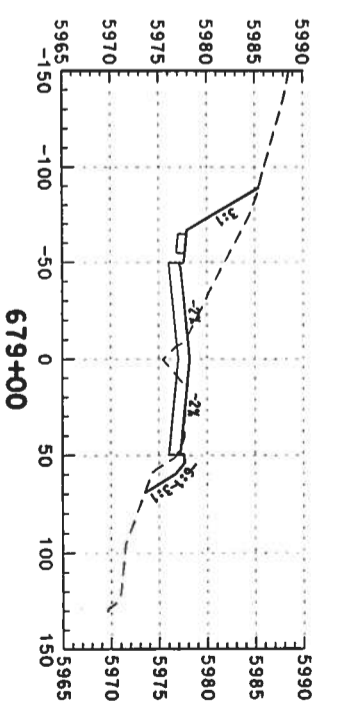
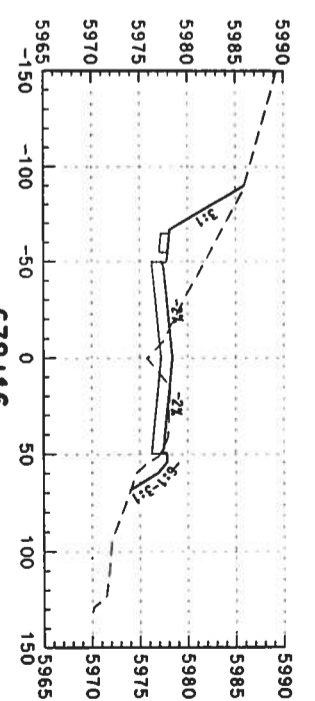
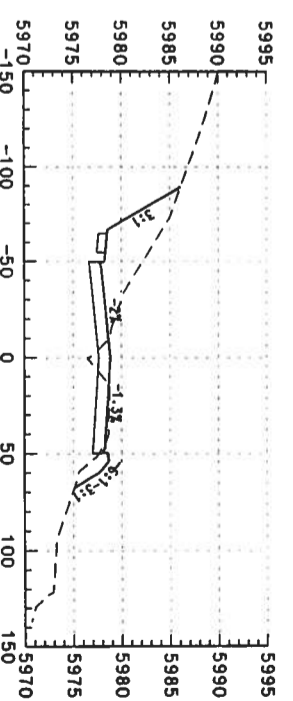
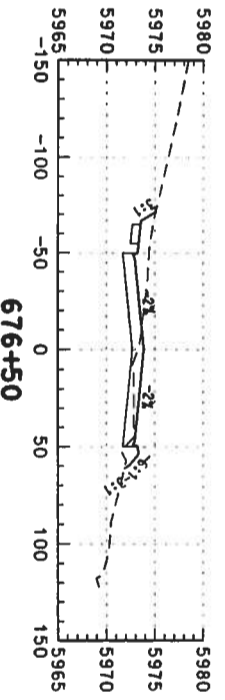
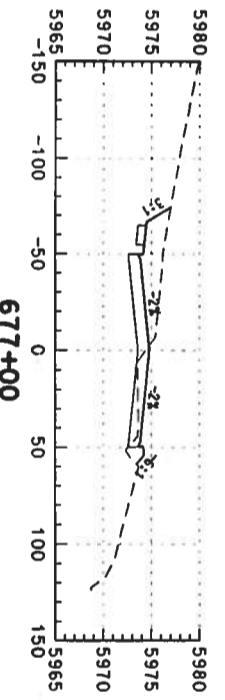
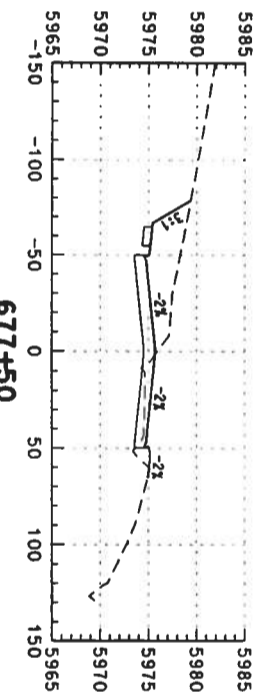
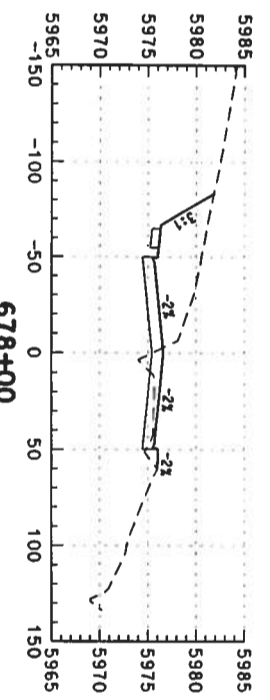
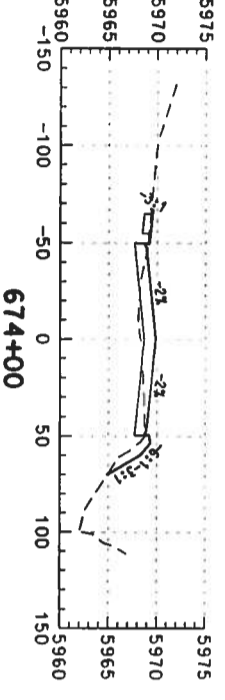
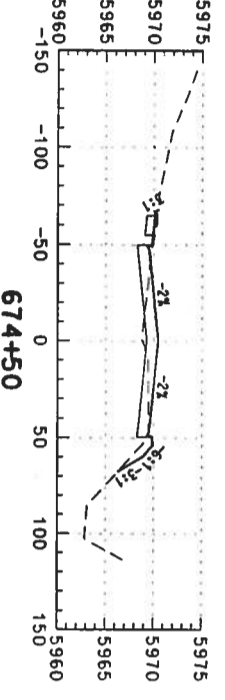
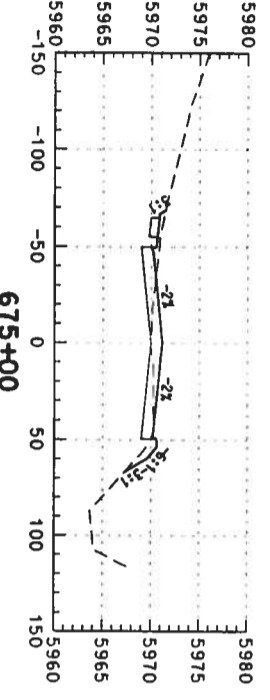
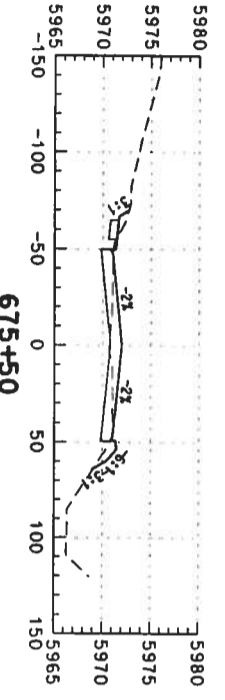
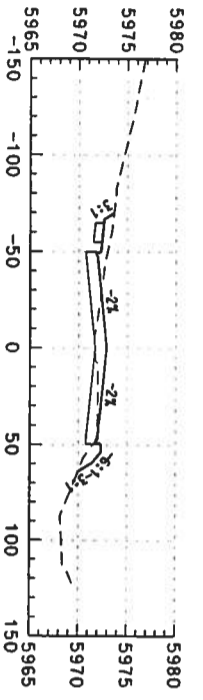

Computer File Information

Creation Date: 02/14/03
 Last Modification Date: 02/14/03
 Full Path: S:\Tranproj\246042\HwyDes\Plans\
 Drawing File Name: rdxs-so-2d137.dgn
 Scale: Units: ENGLISH

Index of Revisions



359 Inverness Dr. South
 Suite K
 Englewood, CO 80112
 Phone: (303) 790-1020
 Fax: (303) 790-1037



5500 Greenwood Plaza Blvd.
 Suite 150
 Greenwood Village, CO 80111
 Phone: 303/221-7275
 Fax: 303/221/7276

As Constructed

No. Revisions:	
Revised:	
Void:	

US 85 CROSS SECTIONS

Designer:	DAF	Structure	
Detailer:	DAF	Numbers	
Sheet Subset:	Roadway	Subset Sheets:	

Project No./Cod
 NH 0852-086

Sheet Number:
 13429
 of 434

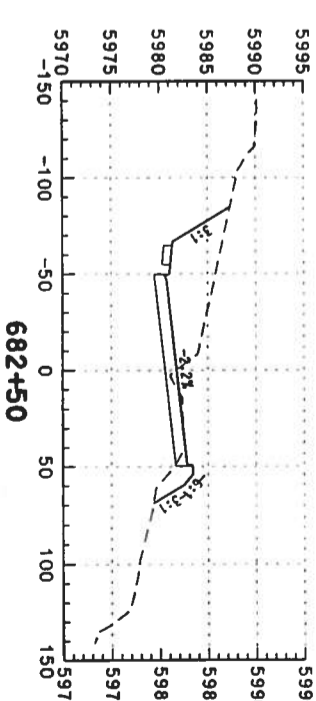
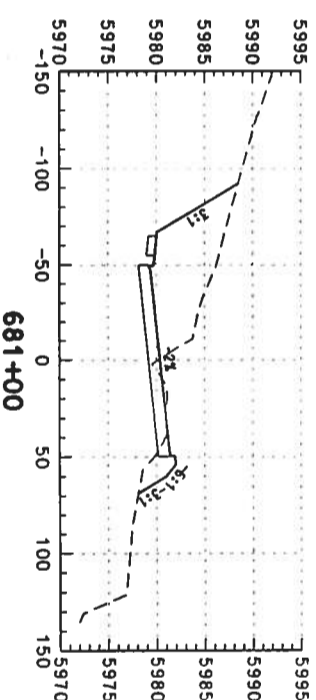
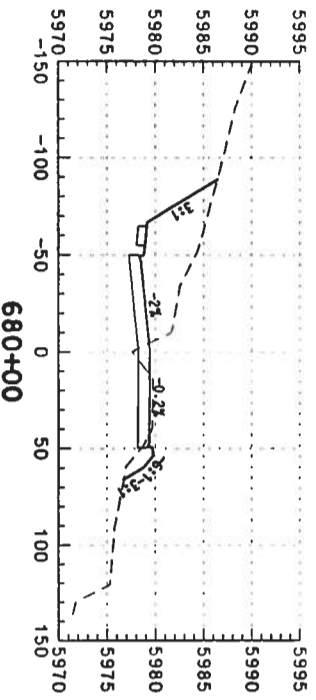
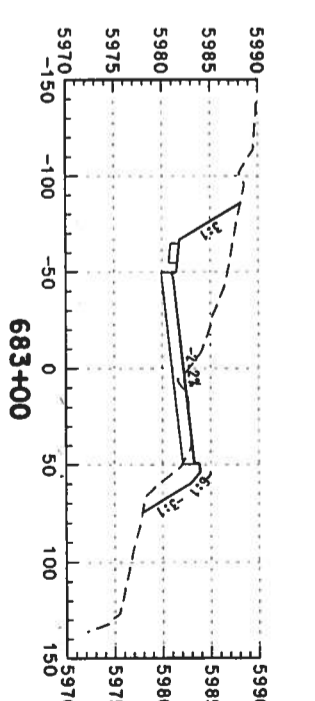
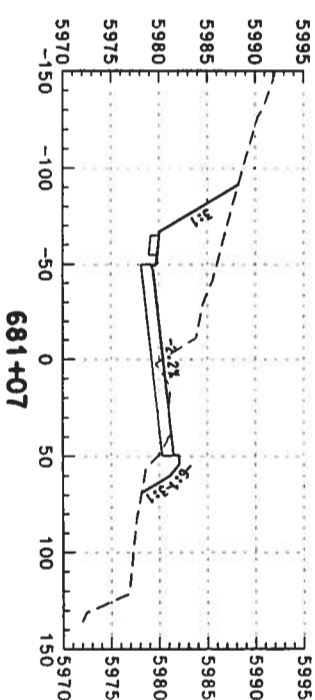
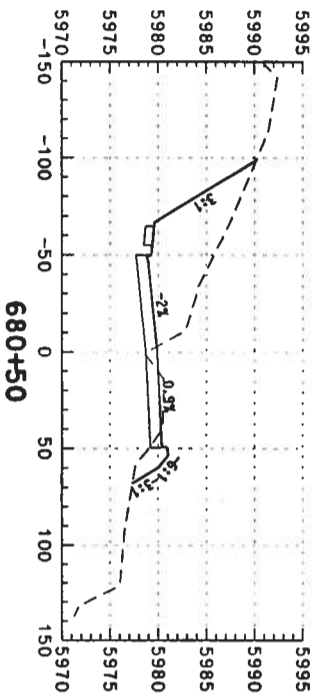
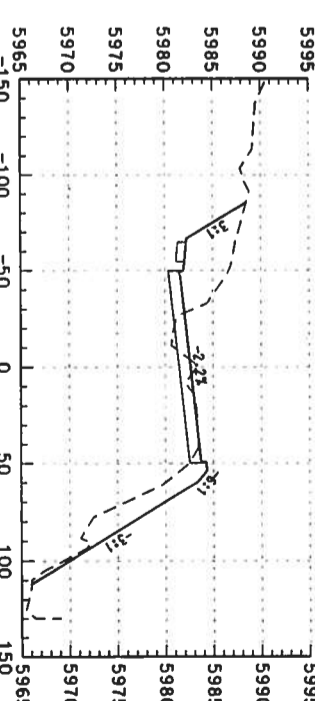
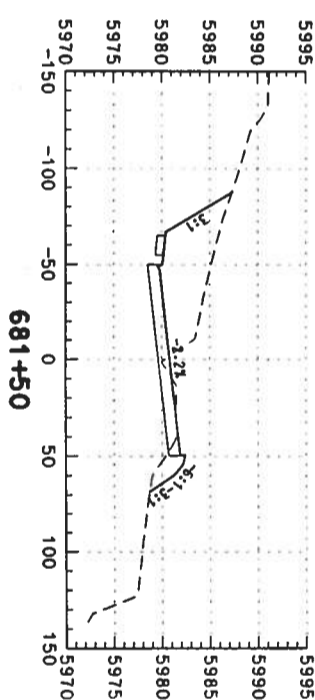
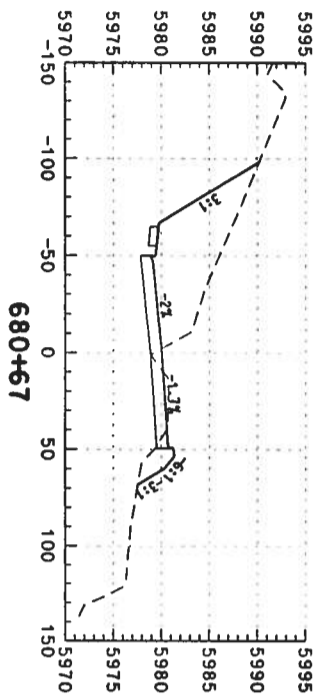
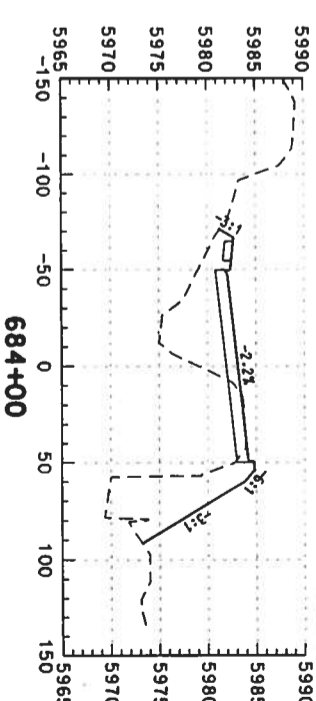
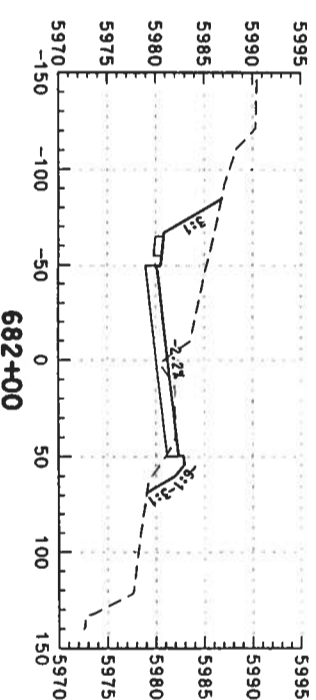
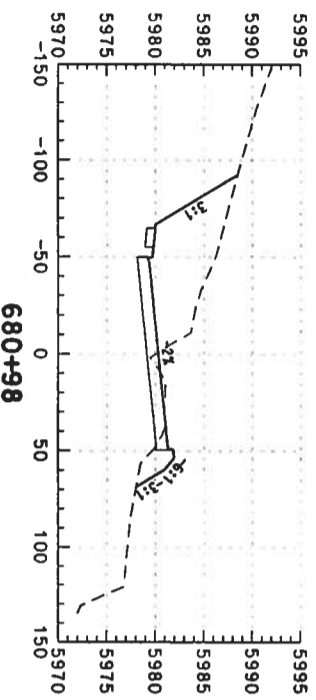

Computer File Information

Creation Date: 02/14/03 Initials: DAF
 Last Modification Date: Initials:
 Full Path: S:\Tranpro\246042\246042\HWYDes\Plans\
 Drawing File Name: rdxs-so-2d138.dgn
 Scale: Units: ENGLISH

Index of Revisions

No.	Description	Date	Initials



DOT
DEPARTMENT OF TRANSPORTATION

359 Inverness Dr. South
 Suite K
 Englewood, CO 80122
 Phone: (303) 790-1020
 Fax: (303) 790-1037

PBSJ

5500 Greenwood Plaza Blvd.
 Suite 150
 Greenwood Village, CO 80111
 Phone: 303/221-7275
 Fax: 303/221-7276

As Constructed

No. Revisions:	
Revised:	
Void:	

US 85 CROSS SECTIONS

Designer:	DAF
Detailer:	DAF
Sheet Subset:	Roadway
Structure Numbers:	
Subset Sheets:	
of	

Project No./Code

NH 0852-086
 13429
 Sheet Number: 437

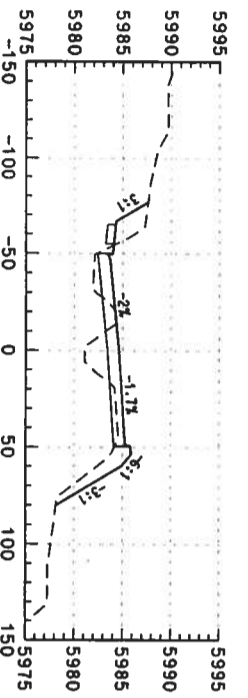

685+18

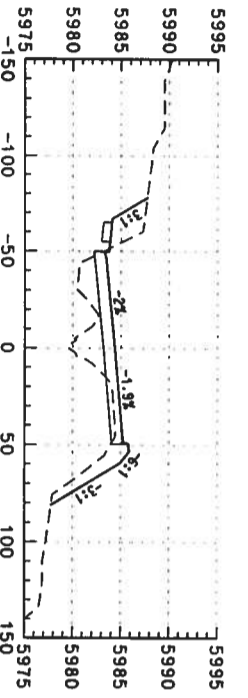

685+00

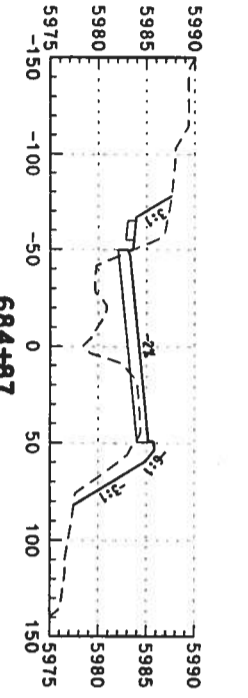

684+87

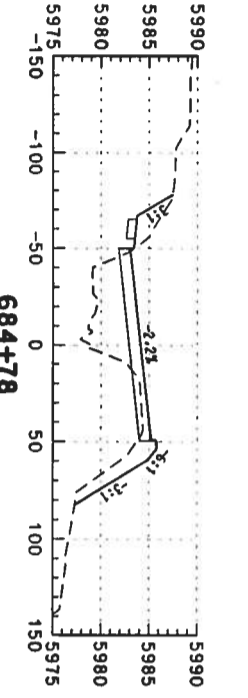

684+78

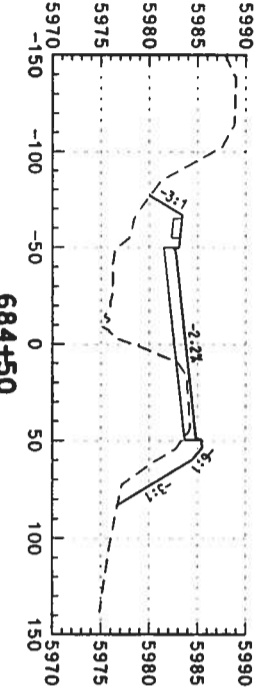

684+50

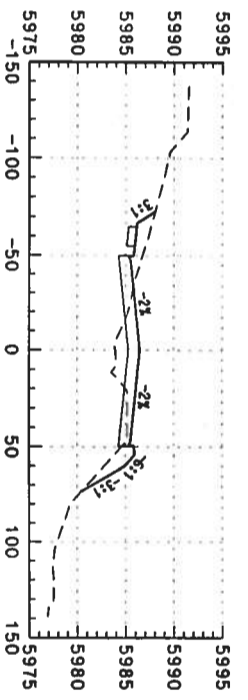

686+69

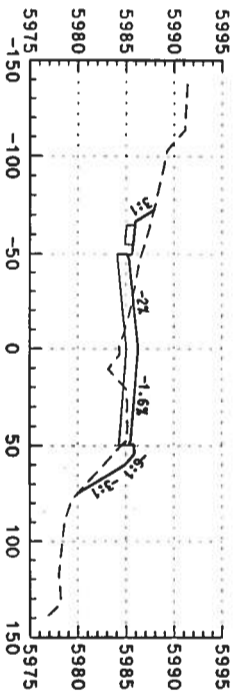

686+50

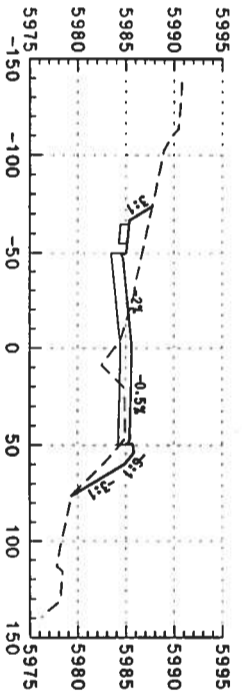

686+00

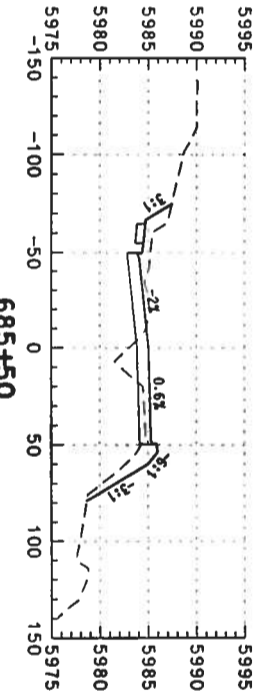

685+50

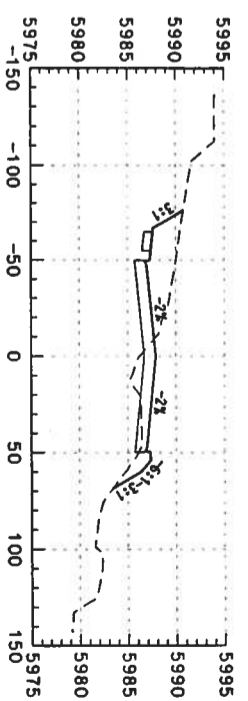

688+50

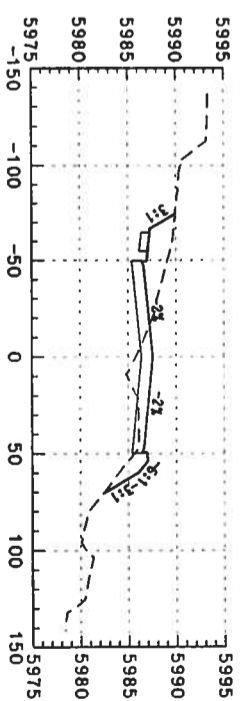

688+00

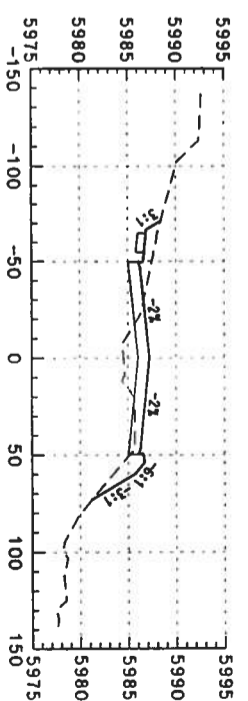

687+50

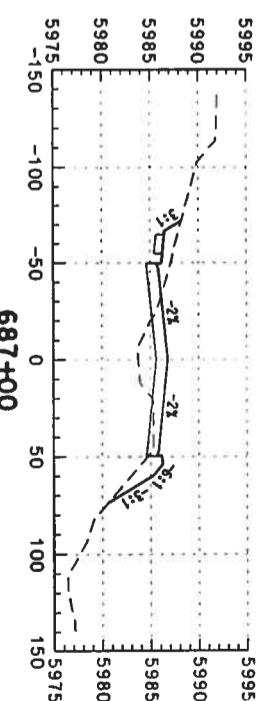

687+00

Computer File Information

Creation Date: 02/14/03 Initials: DAF
 Last Modification Date: Initials:
 Full Path: S:\Tranpro\246042.12\HwyDes\Plans\
 Drawing File Name: rdvs-so-24139.dgn
 Scale: Units: ENGLISH

Index of Revisions



359 Inverness Dr. South
 Suite K
 Englewood, CO 80112
 Phone: (303) 790-1020
 Fax: (303) 790-1037

REGION 1



5500 Greenwood Plaza Blvd.
 Suite 150
 Greenwood Village, CO 80111
 Phone: 303/221-7275
 Fax: 303/221/7276

As Constructed

No. Revisions:
 Revised:
 Void:

US 85 CROSS SECTIONS

Designer: DAF
 Detailer: DAF
 Sheet Subset: Roadway
 Structure Numbers:
 Subset Sheets: of

Project No./Cod

NH 0852-086
 13429
 Sheet Number: 438

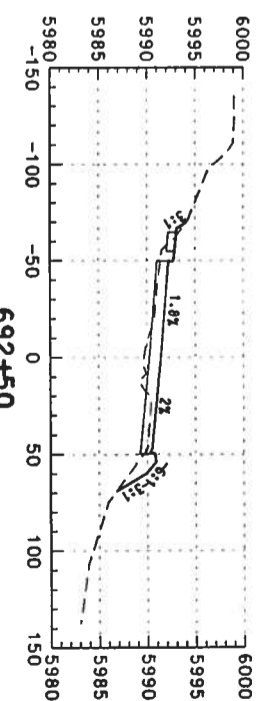
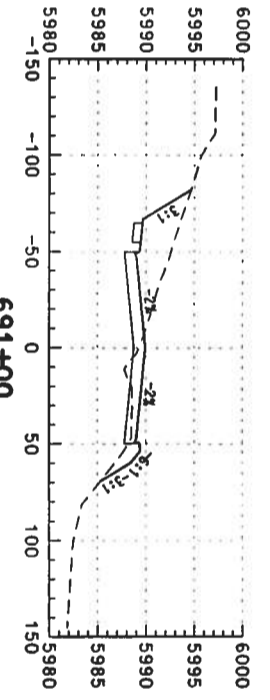
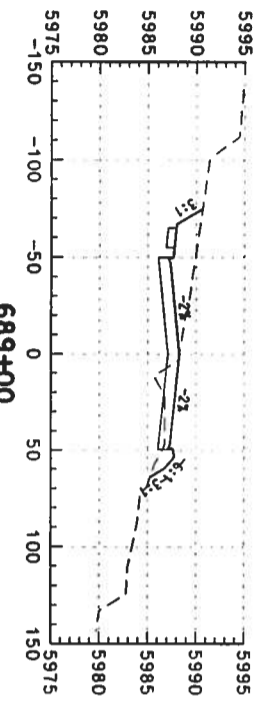
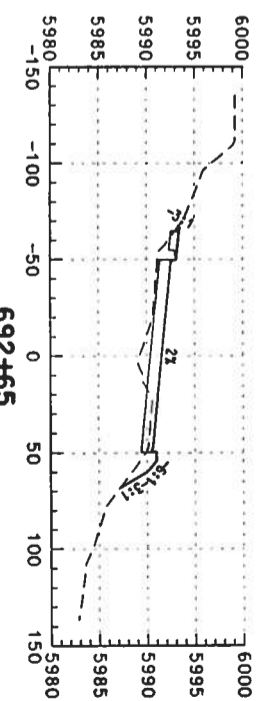
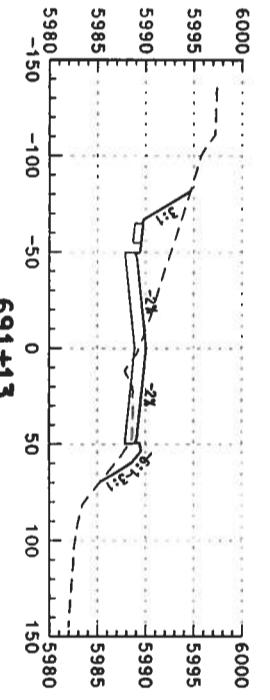
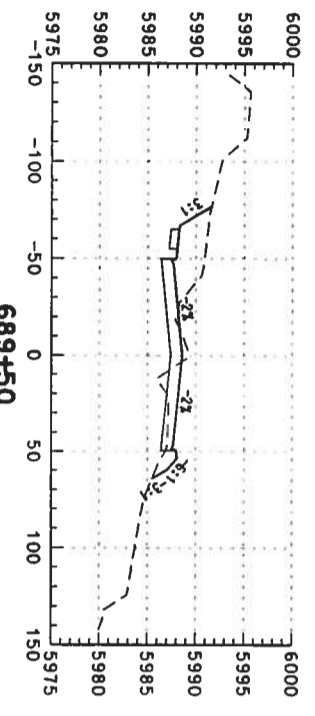
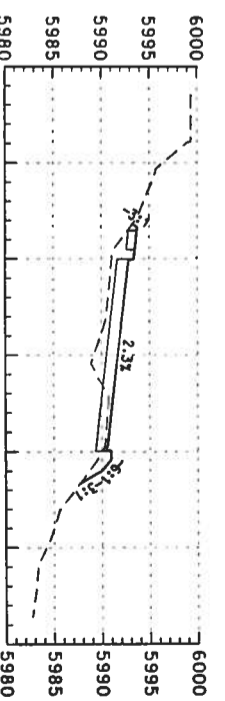
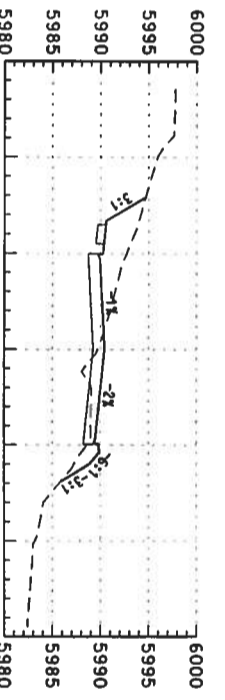
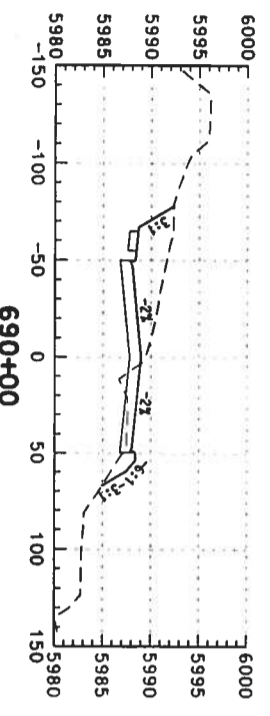
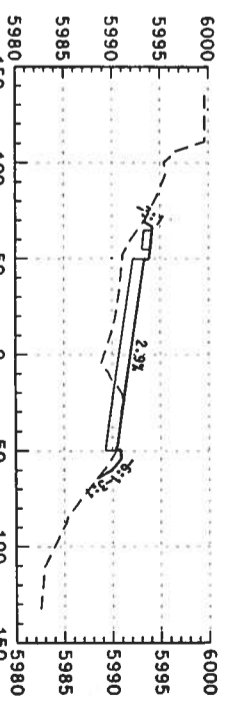
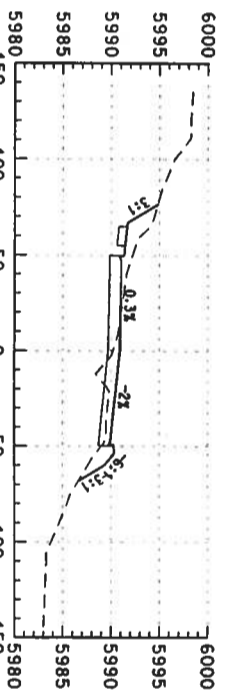
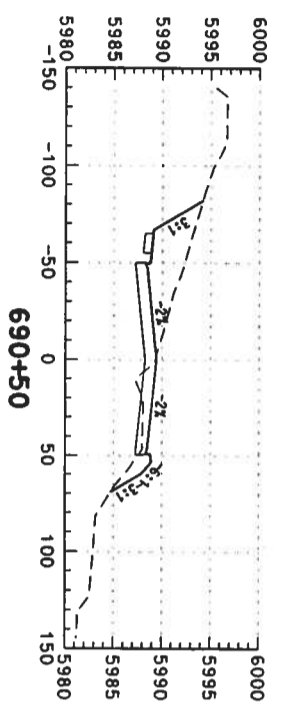

Computer File Information

Creation Date: 02/14/03 Initials: DAF
 Last Modification Date: Initials:
 Full Path: S:\Tranproj\246042.12\HydDes\Plans\
 Drawing File Name: rdxs-so-2d14.dgn
 Scale: Units: ENGLISH

Index of Revisions



359 Inverness Dr. South
 Suite K
 Englewood, CO 80112
 Phone: (303) 790-1020
 Fax: (303) 790-1037

REGION 1



5500 Greenwood Plaza Blvd.
 Suite 150
 Greenwood Village, CO 80111
 Phone: 303/221-7275
 Fax: 303/221/7276

As Constructed

No. Revisions:
 Revised:
 Void:

US 85 CROSS SECTIONS

Designer: DAF
 Detailer: DAF
 Sheet Subset: Roadway
 Subsets: of

Project No./Cod

NH 0852-086
 13429
 Sheet Number: 439

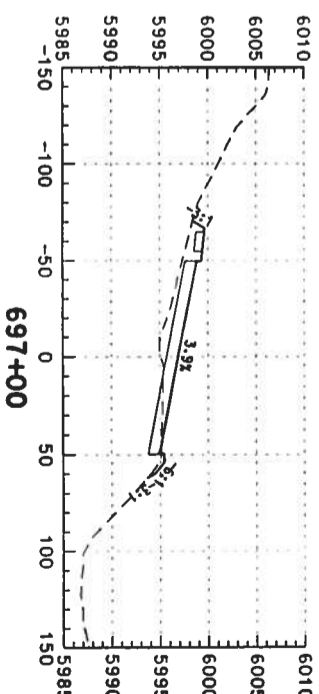
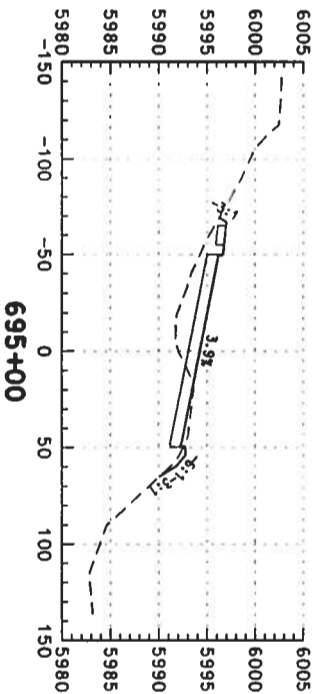
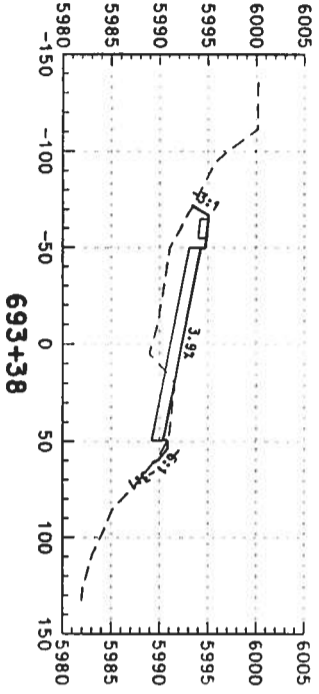
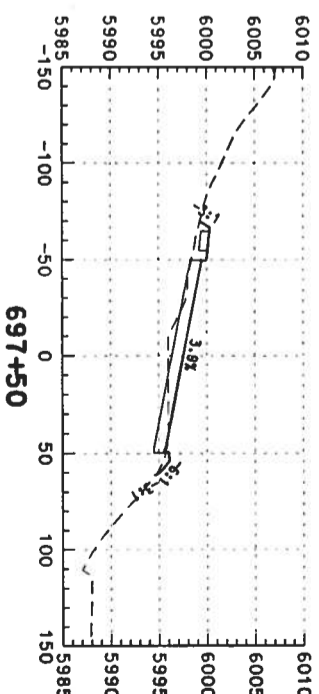
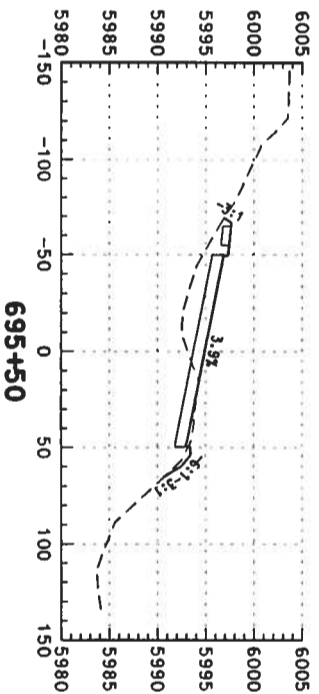
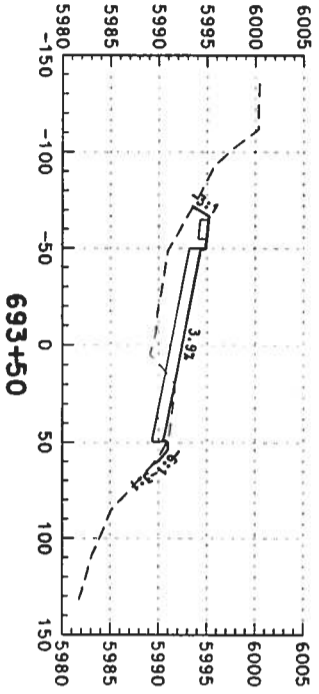
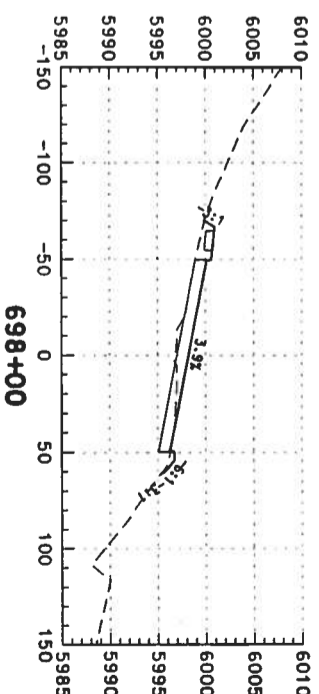
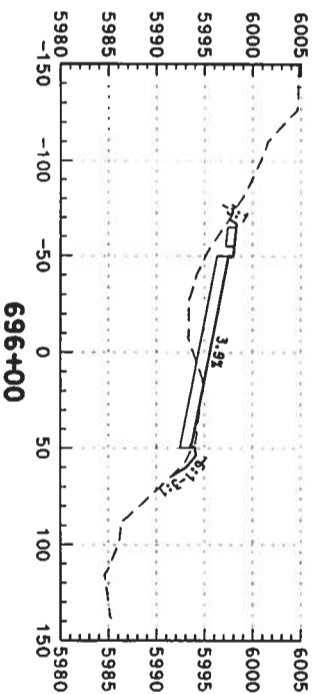
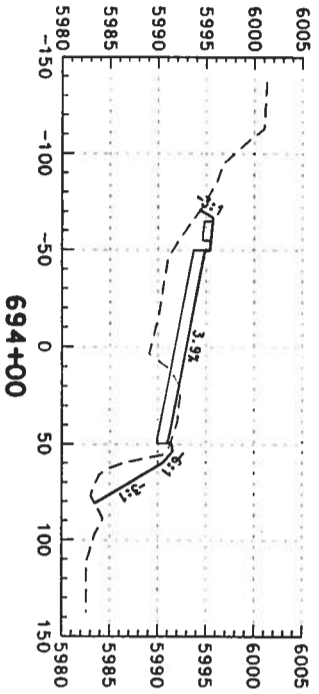
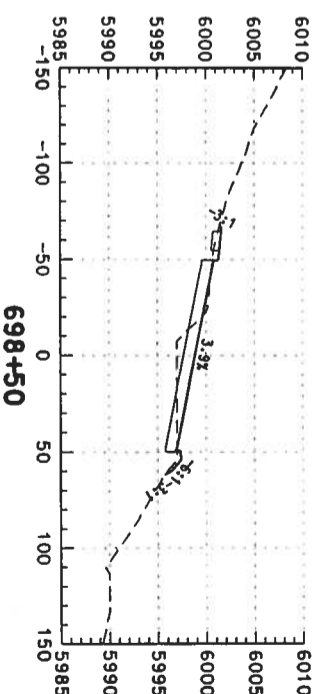
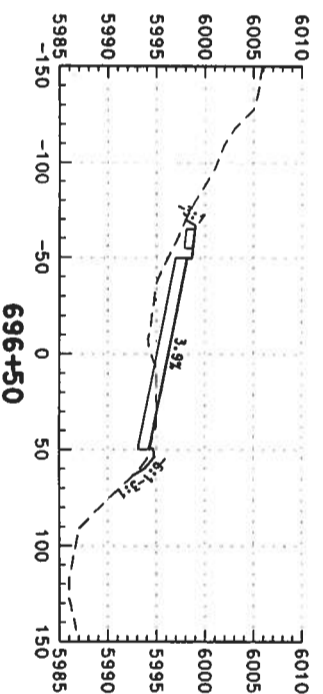
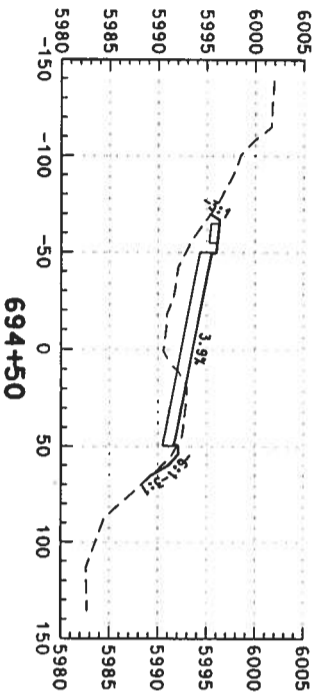

Computer File Information

Creation Date: 02/14/03 Initials: DAF
 Last Modification Date: Initials:
 Full Path: S:\Transport\246042\HydDes\Plans\
 Drawing File Name: rdxs-so-2d141.dgn
 Scale: Units: ENGLISH

Index of Revisions

No.	Description	Date	By



359 Inverness Dr. South
 Suite K
 Englewood, CO 80112
 Phone: (303) 790-1020
 Fax: (303) 790-1037

REGION 1



5500 Greenwood Plaza Blvd.
 Suite 150
 Greenwood Village, CO 80111
 Phone: 303/221-7275
 Fax: 303/221/7276

As Constructed

No. Revisions:
 Revised:
 Void:

US 85 CROSS SECTIONS

Designer: DAF
 Detailer: DAF
 Sheet Subset: Roadway
 Structure Numbers
 Subset Sheets: of

Project No./Code

NH 0852-086
 13429
 Sheet Number: 44

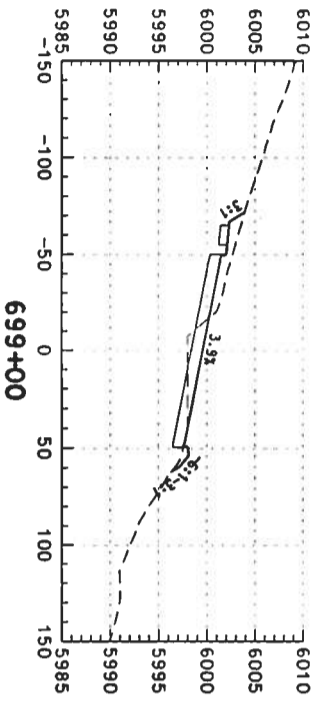
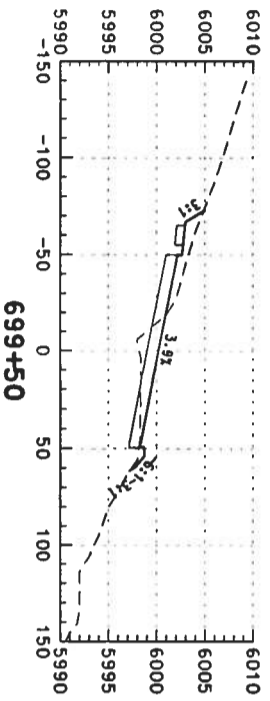
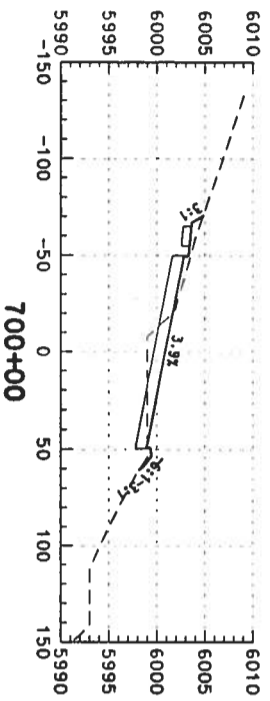

Computer File Information

Creation Date: 02/14/03 Initials: DAF
 Last Modification Date: Initials:
 Full Path: S:\Transport\246042.12\HwyDes\Plans\
 Drawing File Name: rdxs-so-2d142.dgn
 Scale: Units: ENGLISH

Index of Revisions



359 Inverness Dr. South
 Suite K
 Englewood, CO 80112
 Phone: (303) 790-1020
 FAX: (303) 790-1037



5500 Greenwood Plaza Blvd.
 Suite 150
 Greenwood Village, CO 80111
 Phone: 303/221-7275
 Fax: 303/221/7276

As Constructed
 No. Revisions:
 Revised:
 Void:

US 85 CROSS SECTIONS
 Designer: DAF
 Detailer: DAF
 Sheet Subset: Roadway
 Structure Numbers
 Subset Sheets: of

Project No./Coc
 NH 0852-086
 Sheet Number: 13429
 44

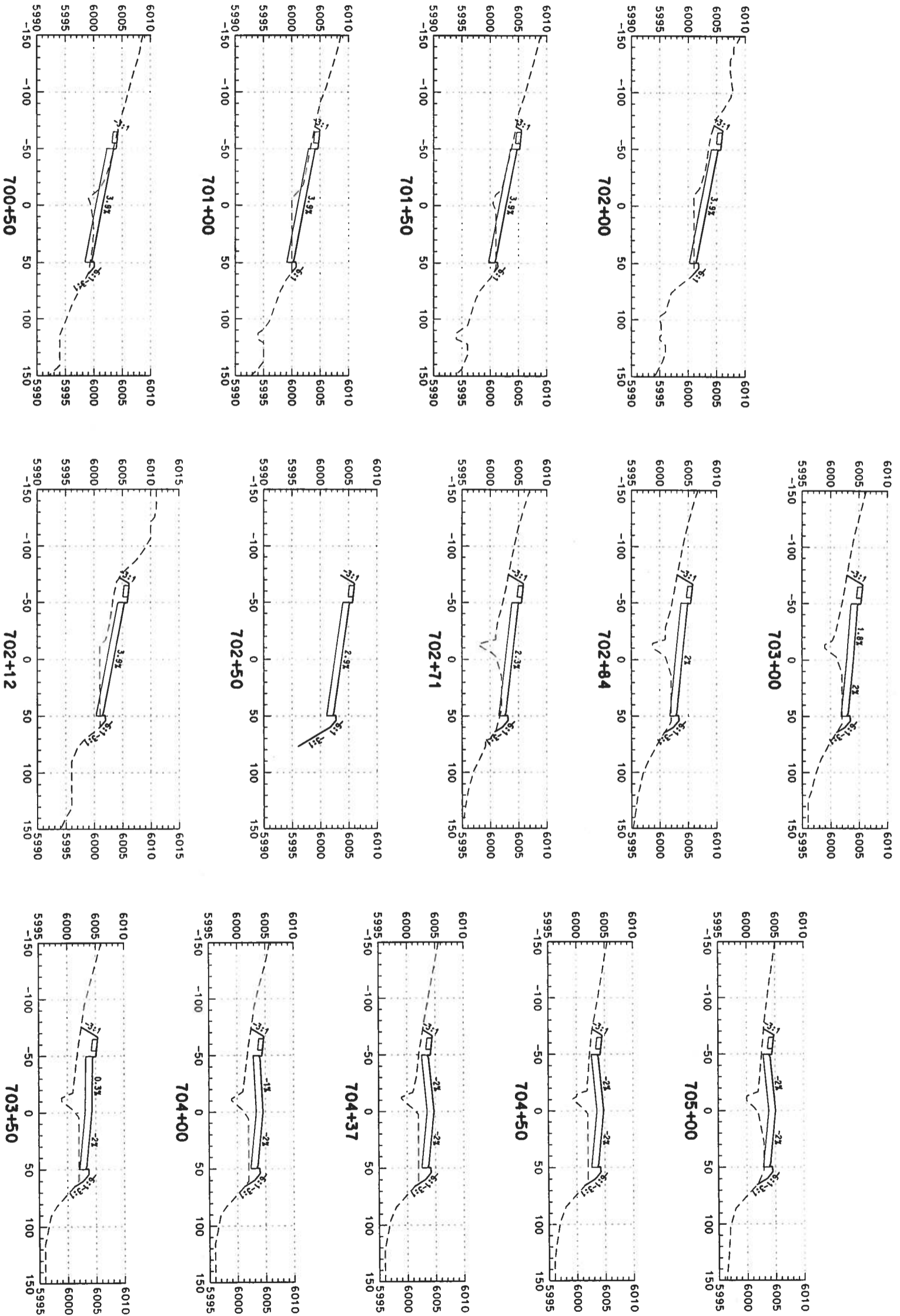

Computer File Information

Creation Date: 02/14/03 Initials: DAF
 Lost Modification Date: Initials:
 Full Path: S:\Tranpro\246042\24HW\Des\Plans\
 Drawing File Name: rdxs-so-2d143.dgn
 Scale: Units: ENGLISH

Index of Revisions

DOT
 359 Inverness Dr. South
 Suite K
 Englewood, CO 80112
 Phone: (303) 790-1020
 FAX: (303) 790-1037

PBS&J
 5500 Greenwood Plaza Blvd.
 Suite 150
 Greenwood Village, CO 80111
 Phone: 303/221-7275
 Fax: 303/221/7276

REGION 1

As Constructed

No. Revisions:
 Revised:
 Void:

US 85 CROSS SECTIONS

Designer: DAF
 Detailer: DAF
 Sheet Subset: Roadway
 Subset Sheets: of

Project No./Cod

NH 0852-086
 13429
 Sheet Number: 442

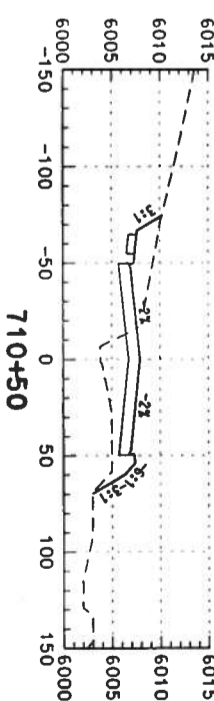
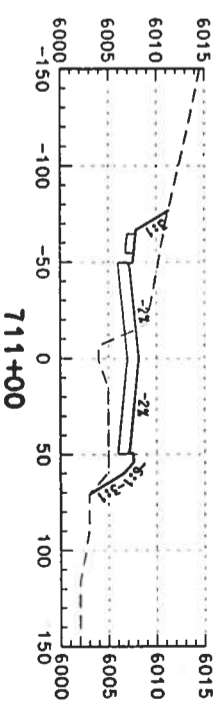
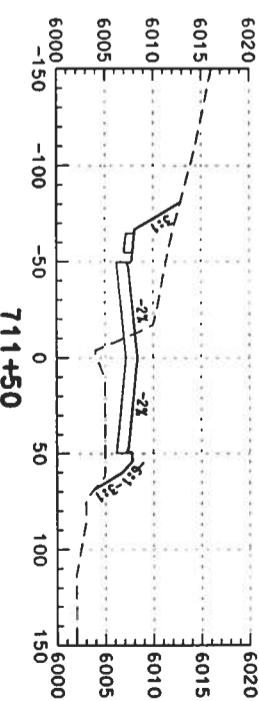
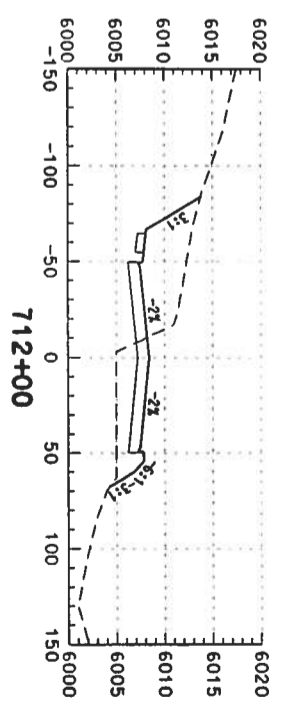
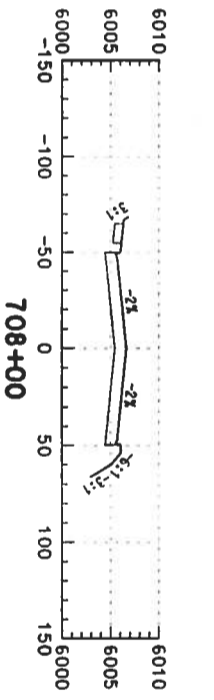
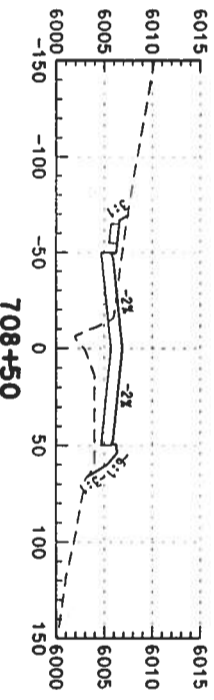
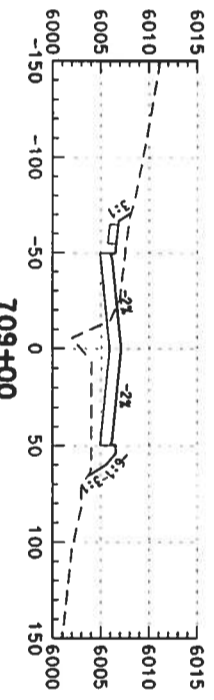
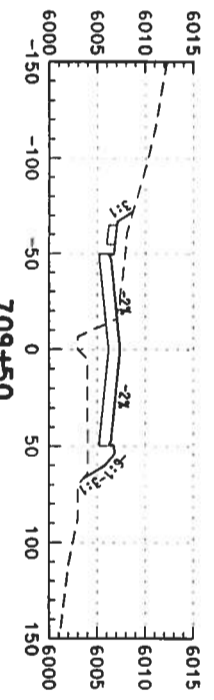
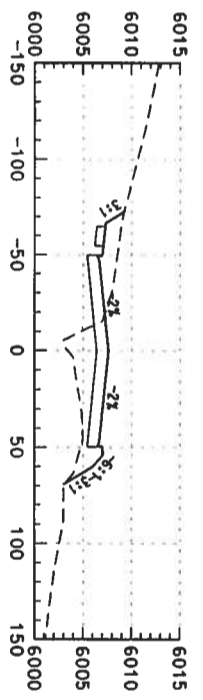
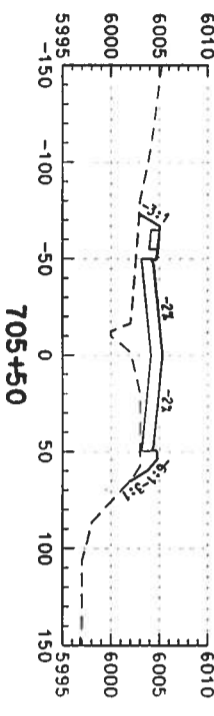
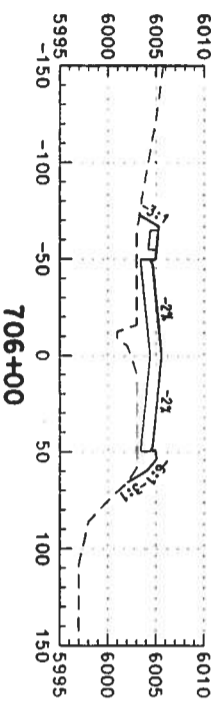
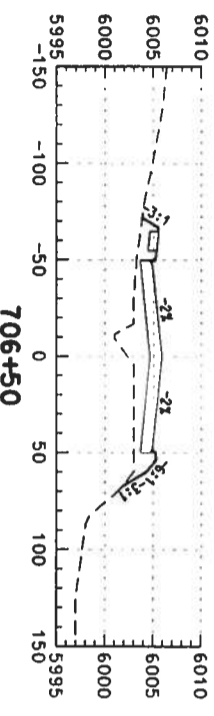
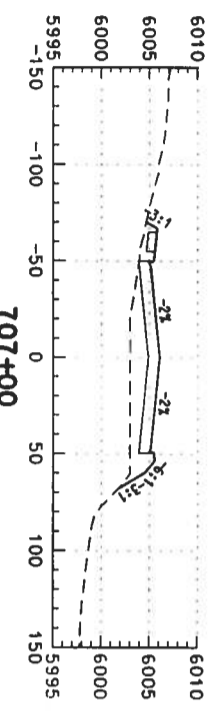
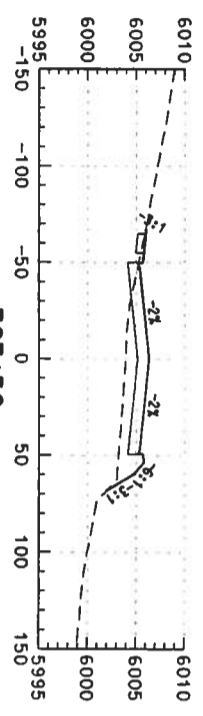

Computer File Information

Creation Date: 02/14/03 Initials: DAF
 Last Modification Date: Initials:
 Full Path: S:\Transport\246042.12\HwyDes\Plans\
 Drawing File Name: rdxs-so-2d14.dgn
 Scale: Units: ENGLISH

Index of Revisions



359 Inverness Dr. South
 Suite K
 Englewood, CO 80112
 Phone: (303) 790-1020
 Fax: (303) 790-1037

REGION 1



5500 Greenwood Plaza Blvd.
 Suite 150
 Greenwood Village, CO 80111
 Phone: 303/221-7275
 Fax: 303/221/7276

As Constructed

No. Revisions:
 Revised:
 Void:

US 85 CROSS SECTIONS

Designer: DAF
 Detailer: DAF
 Sheet Subset: Roadway
 Subset Sheets: of

Project No./Cod

NH 0852-086
 13429
 Sheet Number: 44

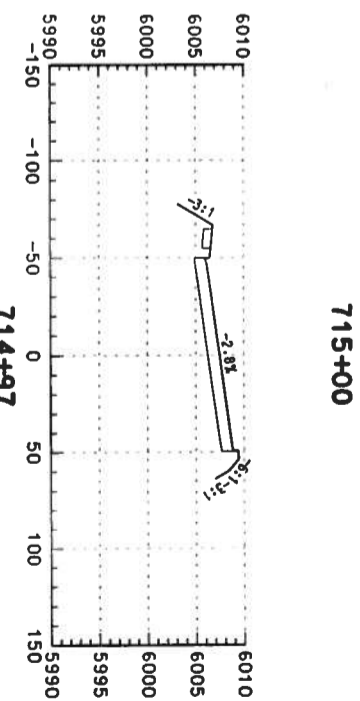
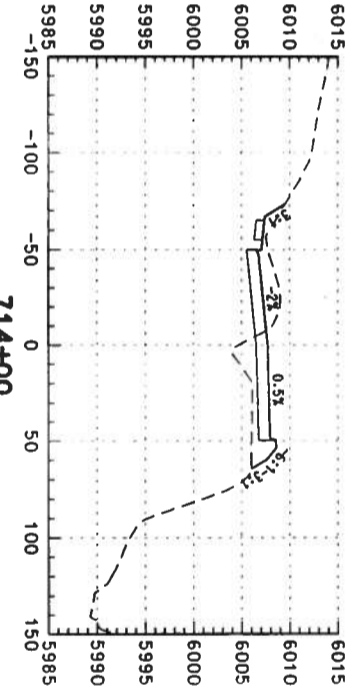
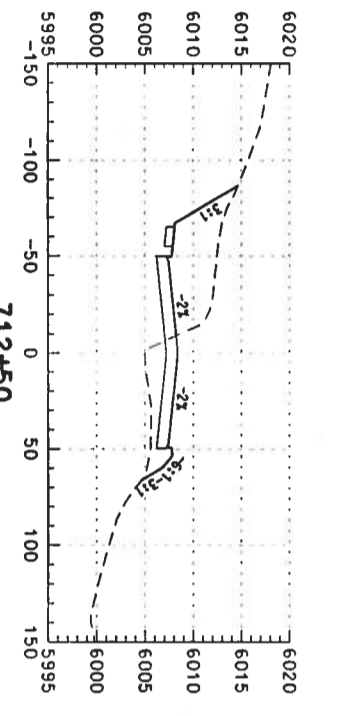
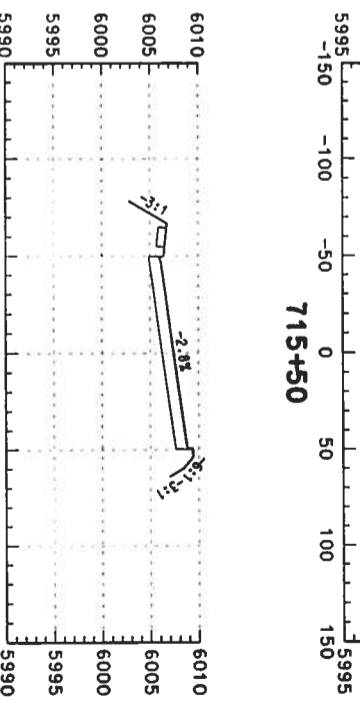
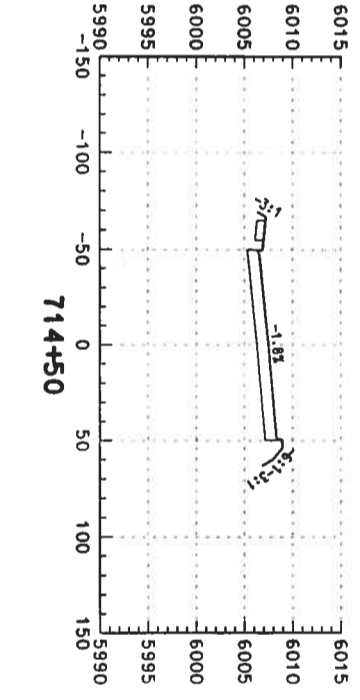
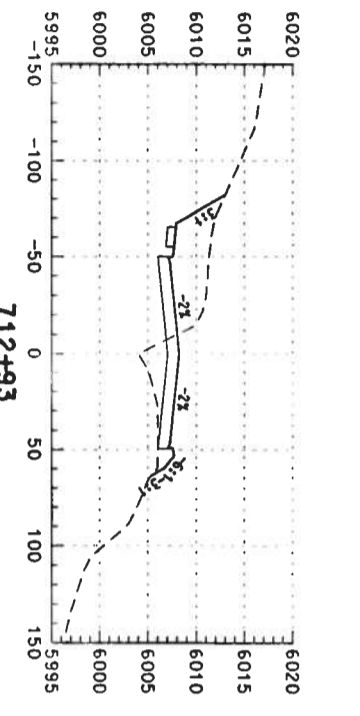
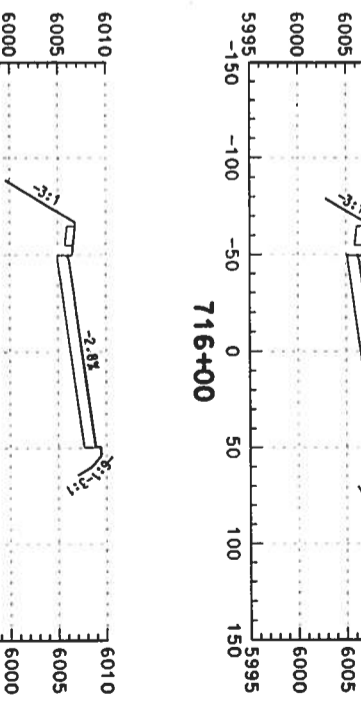
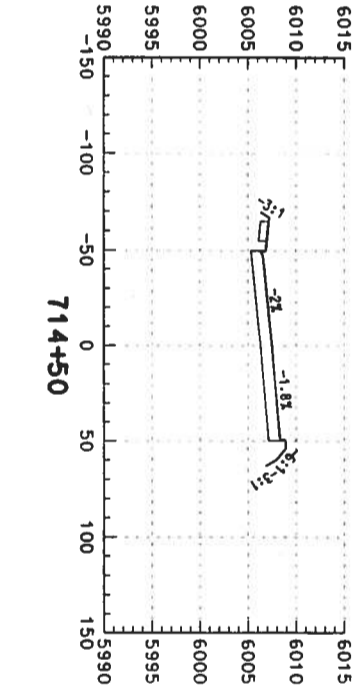
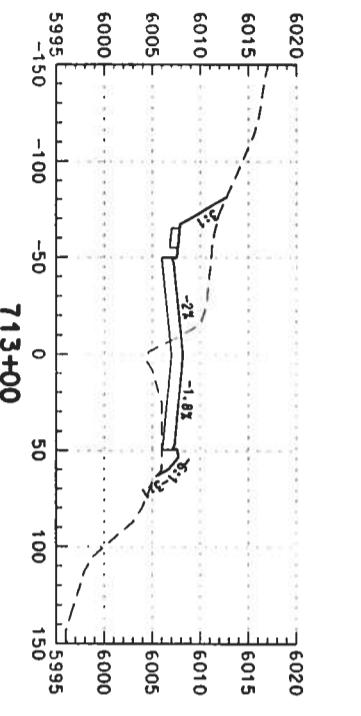
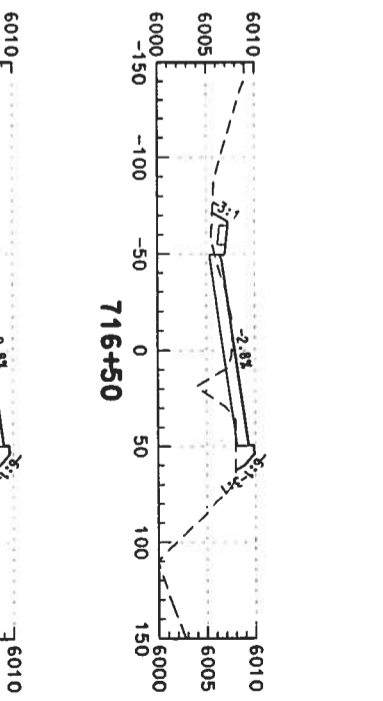
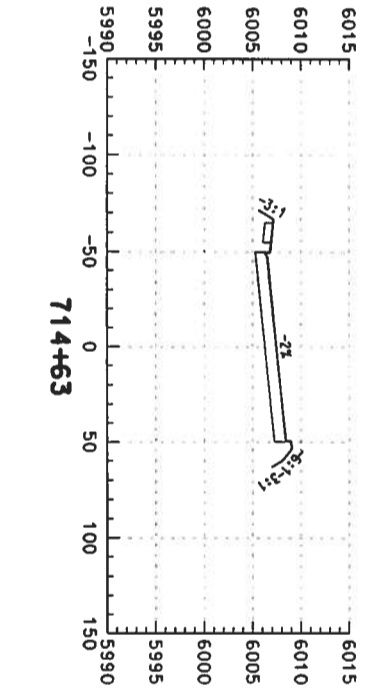
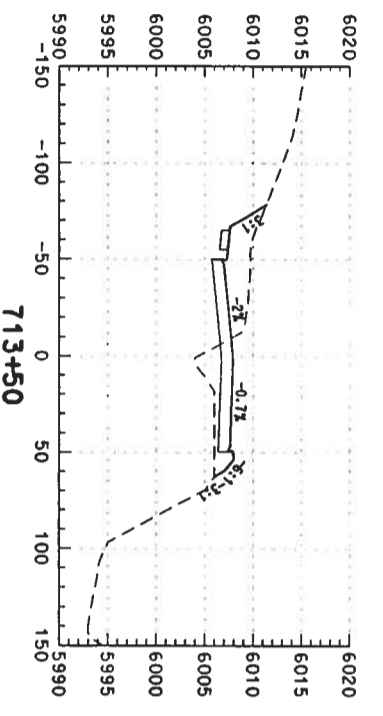

Computer File Information

Creation Date: 02/14/03 Initials: DAF
 Last Modification Date: Initials:
 Full Path: S:\Transport\246042.12\HW\Des\Plans\
 Drawing File Name: rdxs-so-2d145.dgn
 Scale: Units: ENGLISH

Index of Revisions



359 Inverness Dr. South
 Suite K
 Englewood, CO 80112
 Phone: (303) 790-1020
 Fax: (303) 790-1037

REGION 1



5500 Greenwood Plaza Blvd.
 Suite 150
 Greenwood Village, CO 80111
 Phone: 303/221-7275
 Fax: 303/221/7276

As Constructed

No. Revisions:
 Revised:
 Void:

US 85 CROSS SECTIONS

Designer: DAF
 Detailer: DAF
 Sheet Subset: Roadway
 Subsets: of

Project No./Code

NH 0852-086
 13429
 Sheet Number: 444

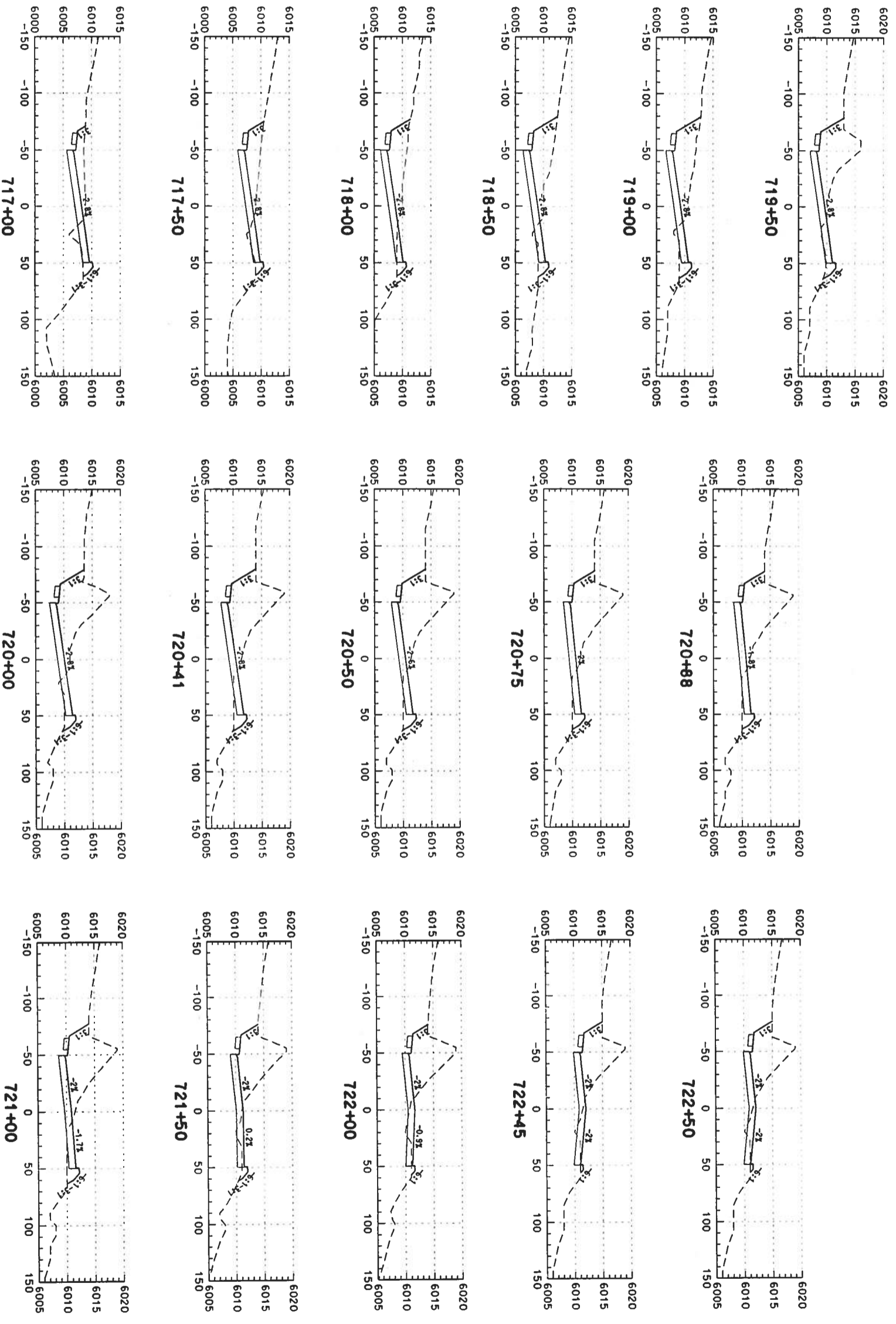

Computer File Information

Creation Date: 02/14/03 Initials: DAF
 Last Modification Date: Initials:
 Full Path: S:\Tranpro\246042\2\HwyDes\Plans\
 Drawing File Name: rdxs-so-2d146.dgn
 Scale: Units: ENGLISH

Index of Revisions

DOT
 DEPARTMENT OF TRANSPORTATION
 358 Inverness Dr. South
 Suite K
 Englewood, CO 80112
 Phone: (303) 790-1020
 Fax: (303) 790-1037

PBSJ
 5500 Greenwood Plaza Blvd.
 Suite 150
 Greenwood Village, CO 80111
 Phone: 303/221-7275
 Fax: 303/221/7276

As Constructed

No. Revisions:	
Revised:	
Void:	

US 85 CROSS SECTIONS

Designer:	DAF
Detailer:	DAF
Sheet Subset:	Roadway
Structure Numbers	
Subset Sheets:	
	of

Project No./Code

NH 0852-086
 13429
 Sheet Number: 445

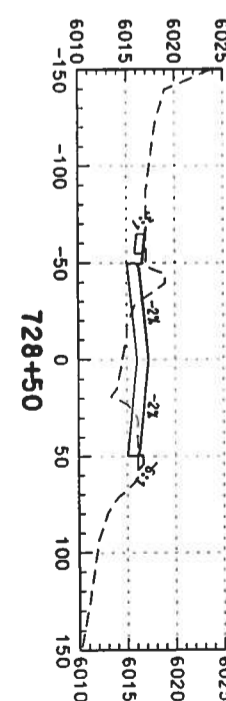
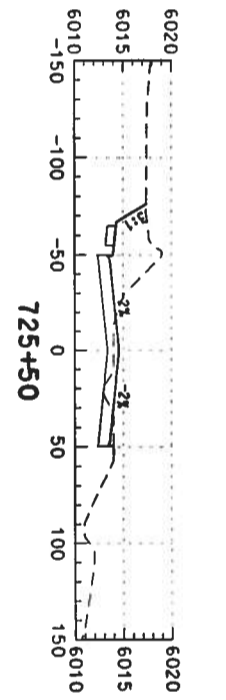
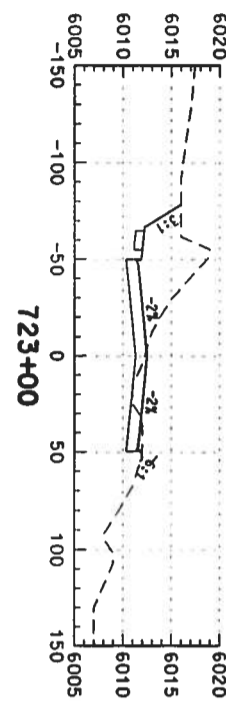
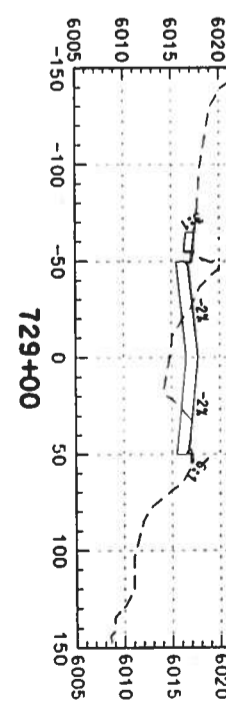
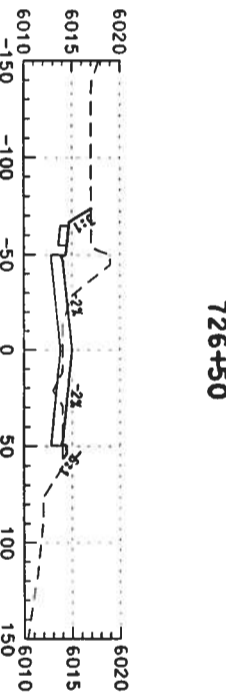
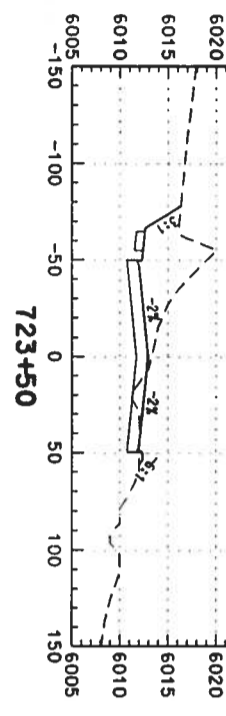
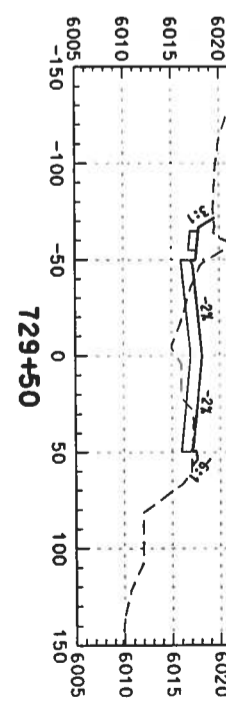
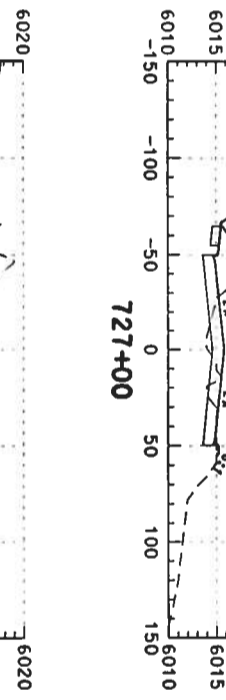
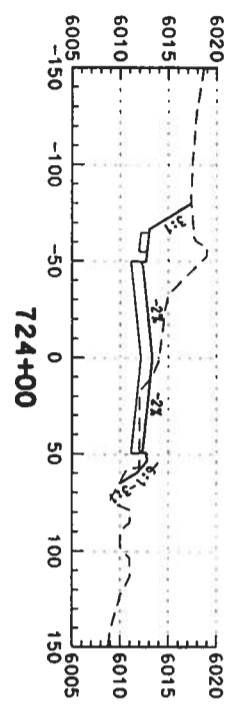
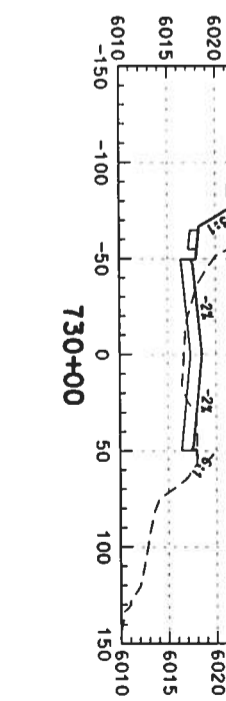
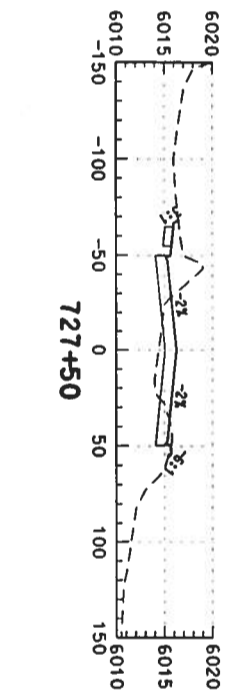
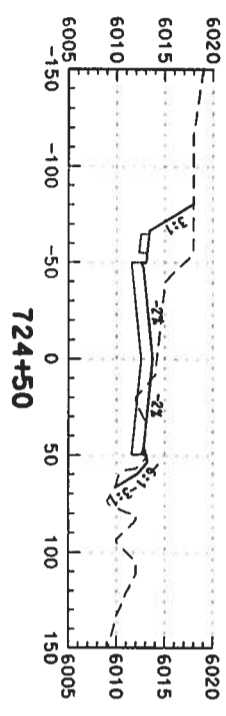
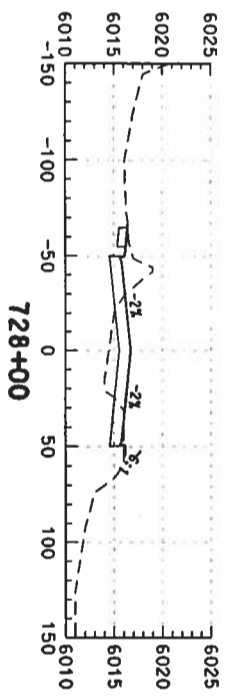
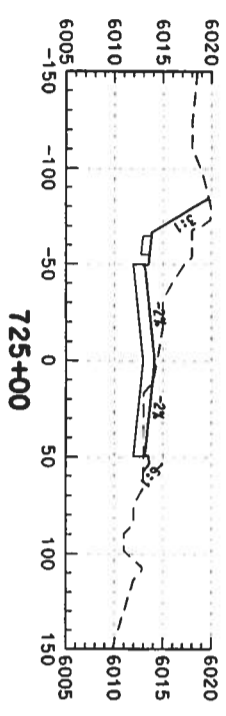

Computer File Information

Creation Date: 02/14/03 Initials: DAF
 Last Modification Date: Initials:
 Full Path: S:\Transport\246042.12\HwyDes\Plans\
 Drawing File Name: rdys-so-24147.dgn
 Scale: Units: ENGLISH

Index of Revisions



359 Inverness Dr. South
 Suite K
 Englewood, CO 80112
 Phone: (303) 790-1020
 Fax: (303) 790-1037

REGION 1



5500 Greenwood Plaza Blvd.
 Suite 150
 Greenwood Village, CO 80111
 Phone: 303/221-7275
 Fax: 303/221/7276

As Constructed

No. Revisions: _____
 Revised: _____
 Void: _____

US 85 CROSS SECTIONS

Designer: DAF
 Detailer: DAF
 Sheet Subset: Roadway
 Subset Sheets: _____ of _____

Project No./Cod

NH 0852-086
 13429
 Sheet Number: 44

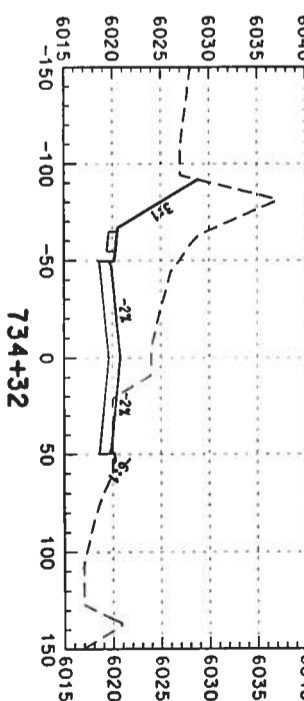
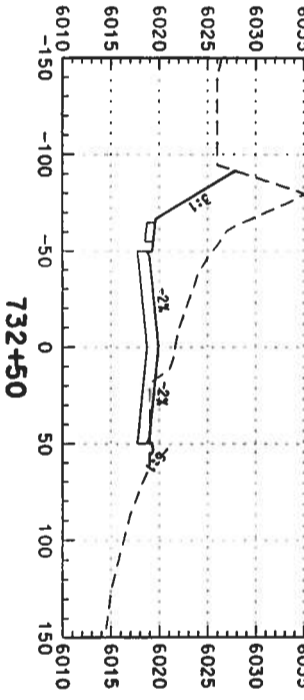
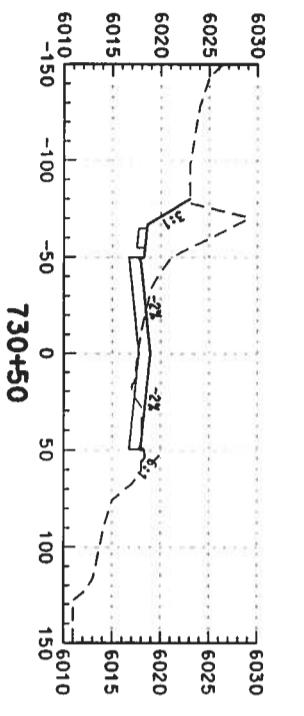
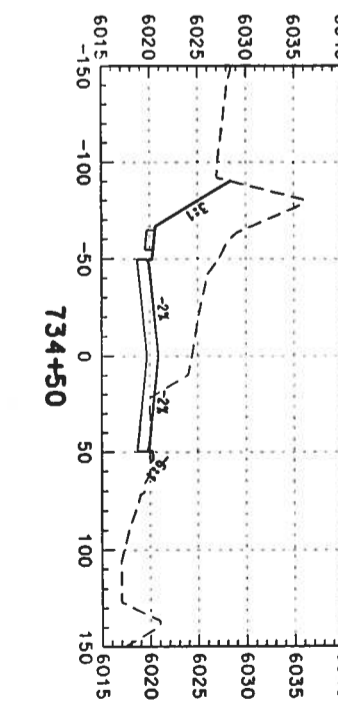
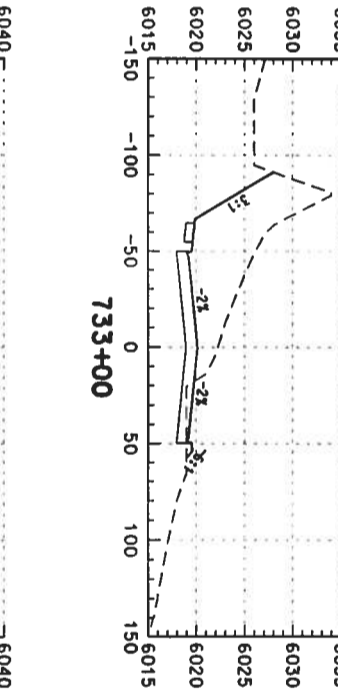
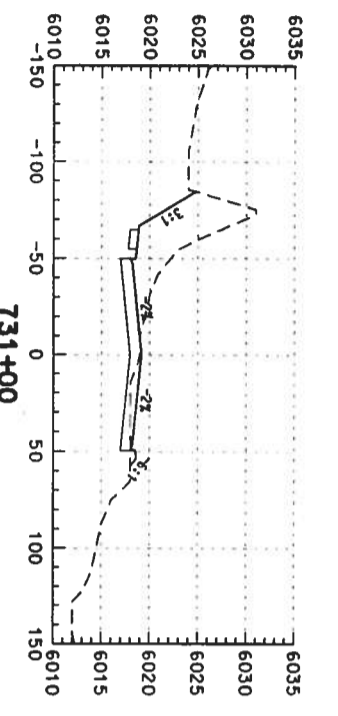
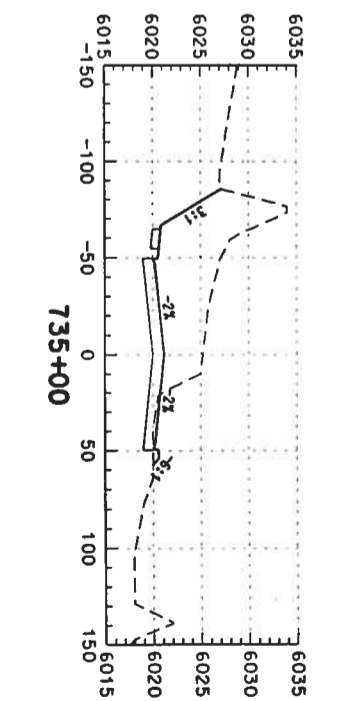
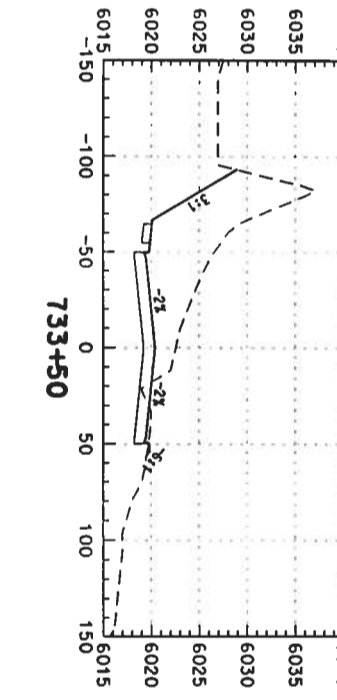
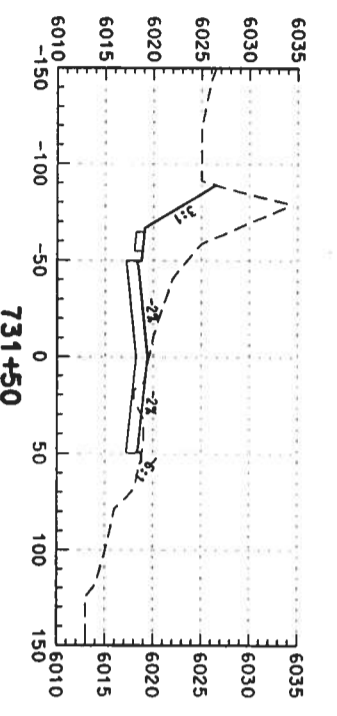
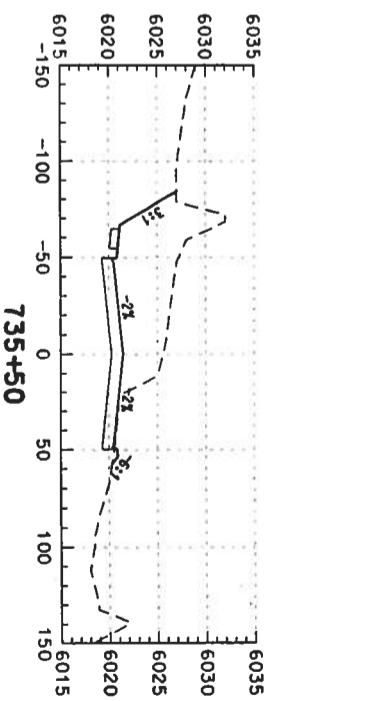
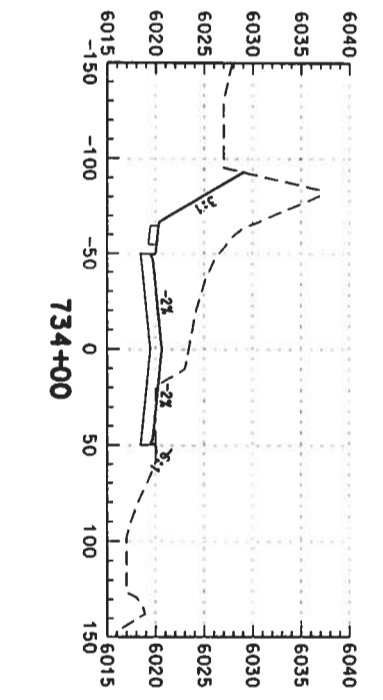
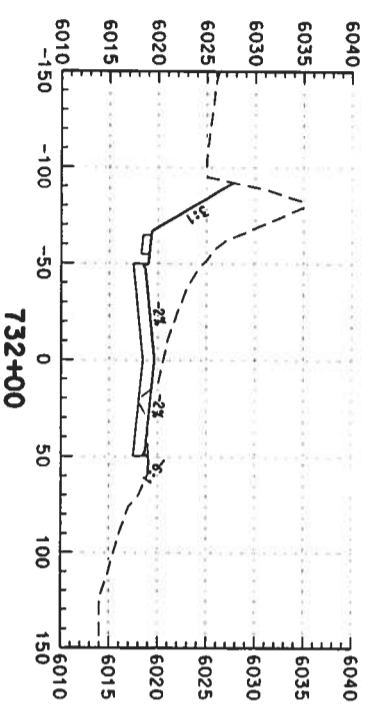

Computer File Information

Creation Date: 02/14/03 Initials: DAF
 Last Modification Date: Initials:
 Full Path: S:\Temp\proj\246042.12\HwyDes\Plans\
 Drawing File Name: rdxs-so-2d148.dgn
 Scale: Units: ENGLISH

Index of Revisions



358 Inverness Dr. South
 Suite K
 Englewood, CO 80112
 Phone: (303) 790-8020
 Fax: (303) 790-0037

REGION 1



5500 Greenwood Plaza Blvd.
 Suite 150
 Greenwood Village, CO 80111
 Phone: 303/221-7275
 Fax: 303/221/7276

As Constructed

No. Revisions:	
Revised:	
Void:	

US 85 CROSS SECTIONS

Designer:	DAF
Detailer:	DAF
Sheet Subset:	Roadway
Structure Numbers:	
Subset Sheets:	
	of

Project No./Cod

NH 0852-086
 13429
 Sheet Number: 44-

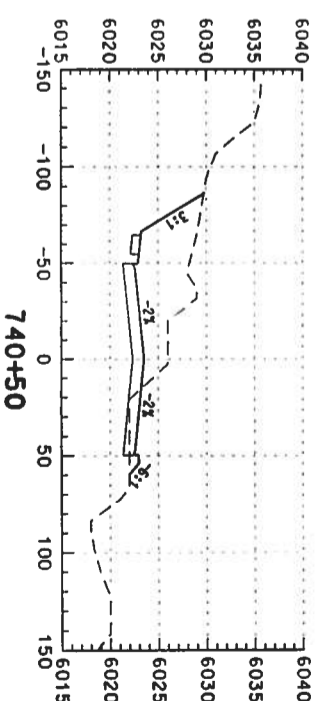
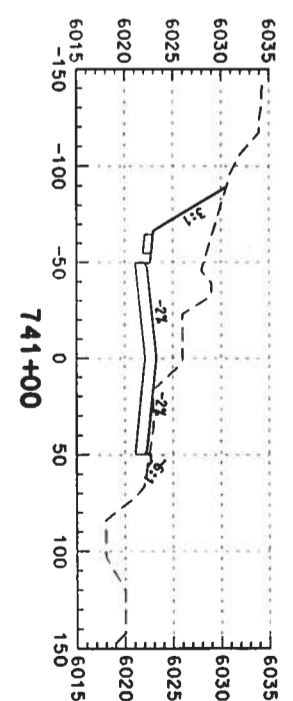
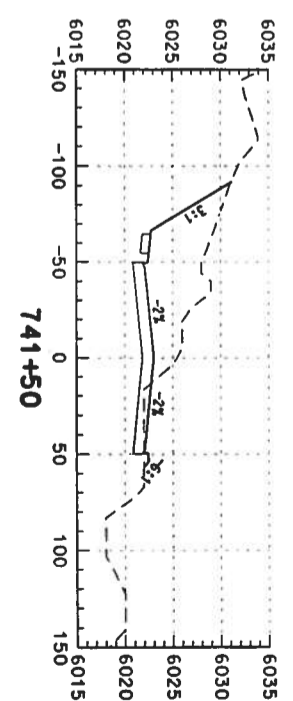
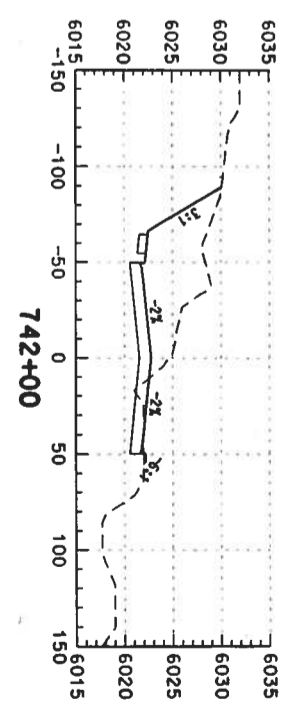
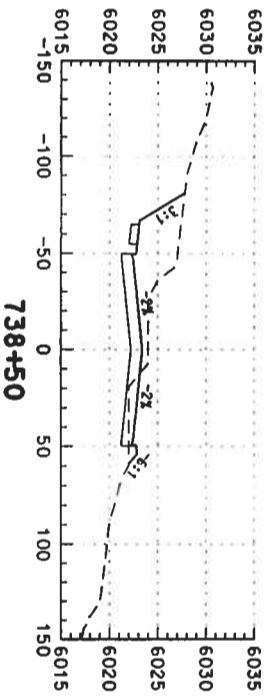
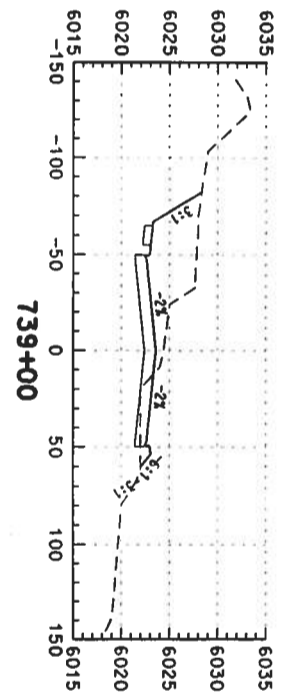
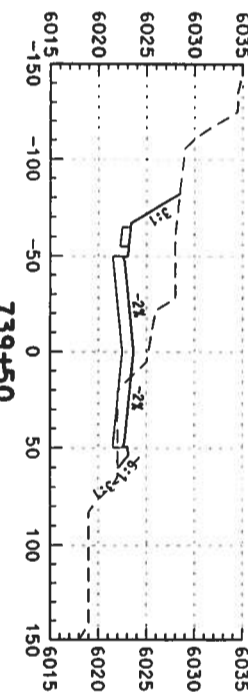
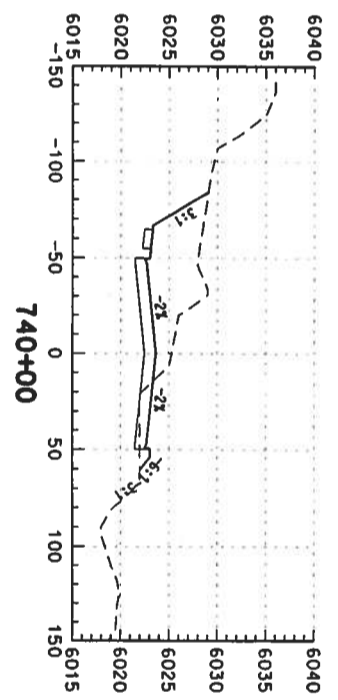
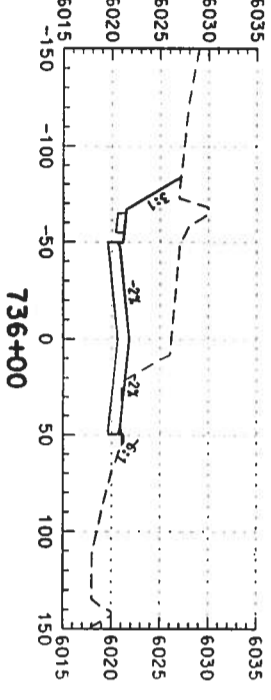
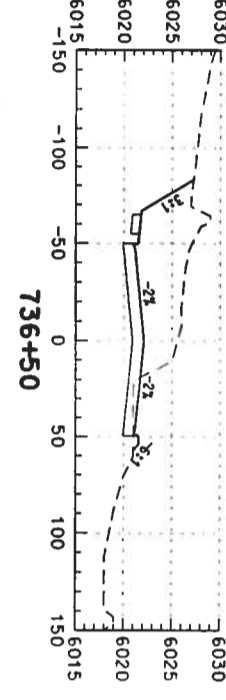
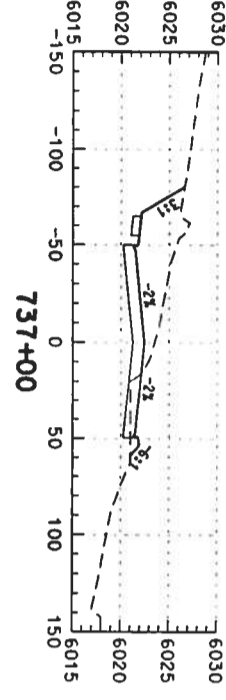
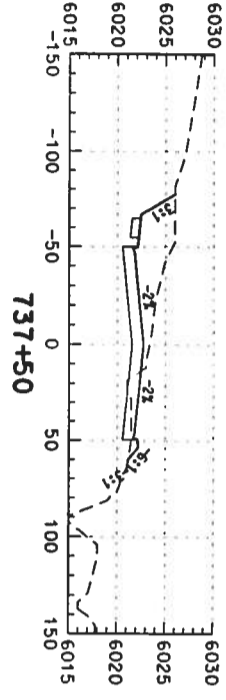
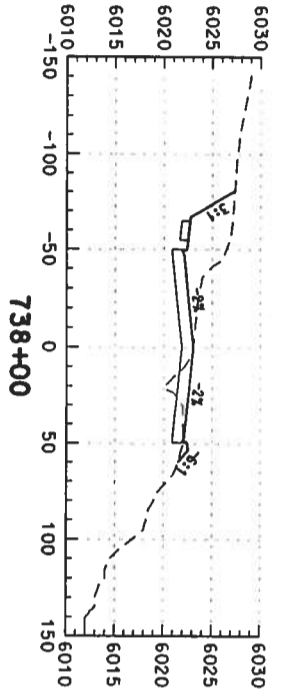

Computer File Information
 Creation Date: 02/14/03 Initials: DAF
 Last Modification Date: Initials:
 Full Path: S:\Tranpro\246042.12\HW\Des\Plans\
 Drawing File Name: rdxs-so-2d149.dgn
 Scale: Units: ENGLISH

Index of Revisions

DOT
 DEPARTMENT OF TRANSPORTATION
 359 Inverness Dr. South
 Suite K
 Englewood, CO 80112
 Phone: (303) 790-1020
 FAX: (303) 790-1037

PBSJ
 5500 Greenwood Plaza Blvd.
 Suite 150
 Greenwood Village, CO 80111
 Phone: 303/221-7275
 Fax: 303/221/7276

As Constructed

No. Revisions:	
Revised:	
Void:	

US 85 CROSS SECTIONS

Designer:	DAF	Structure	
Detailer:	DAF	Numbers	
Sheet Subset:	Roadway	Subset Sheets:	

Project No./Cod
 NH 0852-086
 13429
 Sheet Number: 448

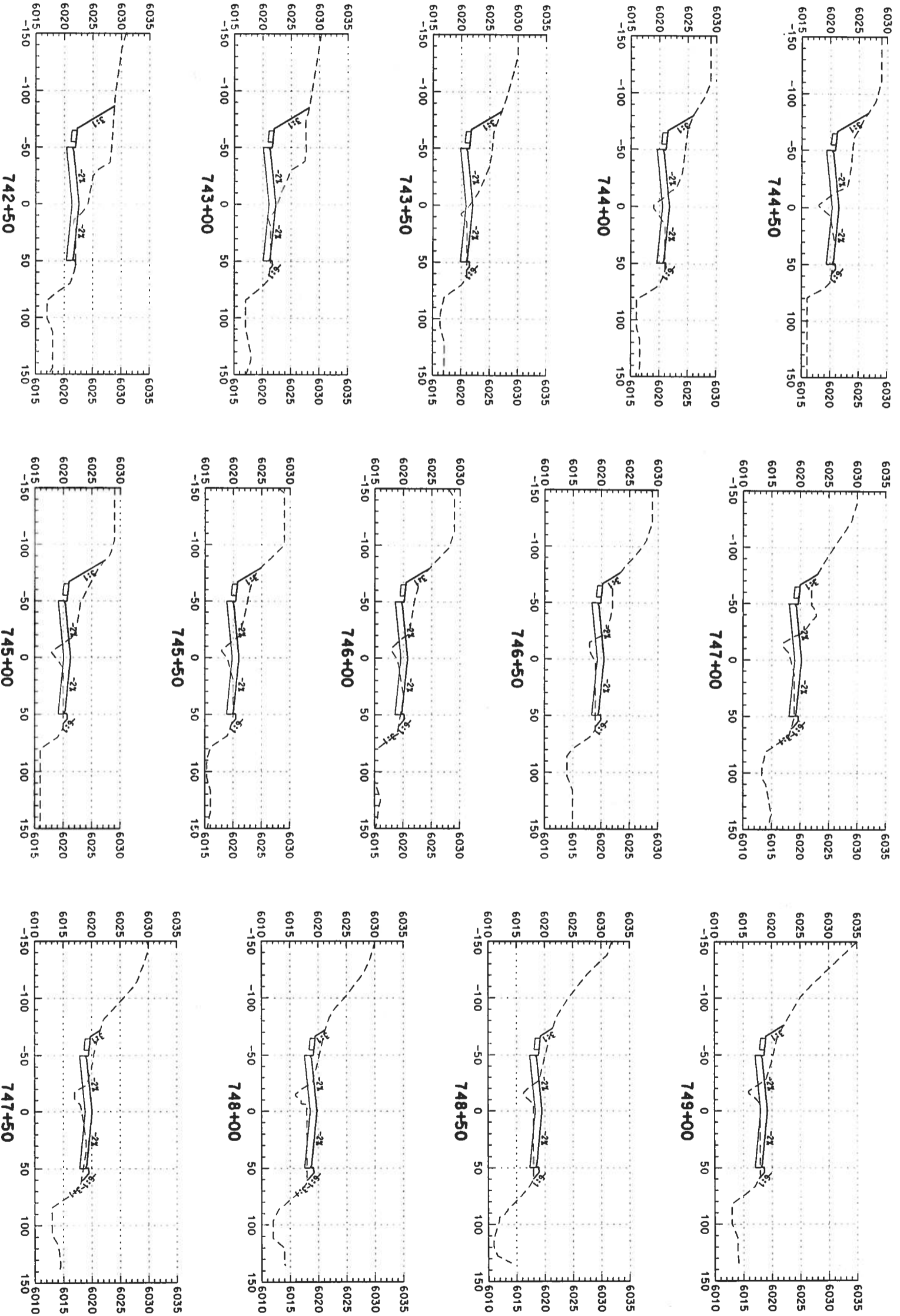

Computer File Information

Creation Date: 02/14/03 Initials: DAF
 Last Modification Date: Initials:
 Full Path: S:\Tranpro\246042.12\HyDes\Plans\
 Drawing File Name: rdxs-so-2d150.dgn
 Scale: Units: ENGLISH

Index of Revisions

No.	Description

359 Inverness Dr. South
 Suite K
 Englewood, CO 80112
 Phone: (303) 790-1020
 Fax: (303) 790-1037

REGION 1

5500 Greenwood Plaza Blvd.
 Suite 150
 Greenwood Village, CO 80111
 Phone: 303/221-7275
 Fax: 303/221/7276

As Constructed

No. Revisions:	
Revised:	
Void:	

US 85 CROSS SECTIONS

Designer:	DAF	Structure	
Detailer:	DAF	Numbers	
Sheet Subset:	Roadway	Subset Sheets:	of

Project No./Cod

NH 0852-086
 13429
 Sheet Number: 449

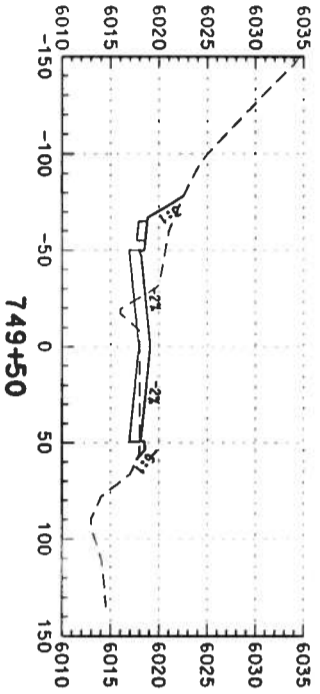
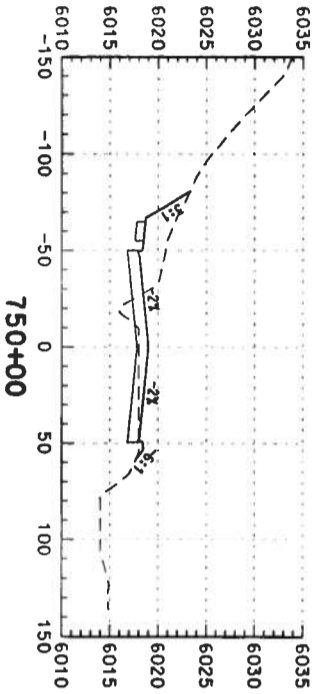

Computer File Information

Creation Date: 02/14/03 Initials: DAF
 Last Modification Date: Initials:
 Full Path: S:\Tranpro\246042\246042\HwyDes\Plans\
 Drawing File Name: rdxs-so-2d151.dgn
 Scale: Units: ENGLISH

Index of Revisions

No.	Description	Date	Initials



DOT
 DEPARTMENT OF TRANSPORTATION
 REGION 1
 359 Inverness Dr. South
 Suite K
 Englewood, CO 80112
 Phone: (303) 790-1020
 Fax: (303) 790-1037



PBSJ
 5500 Greenwood Plaza Blvd.
 Suite 150
 Greenwood Village, CO 80111
 Phone: 303/221-7275
 Fax: 303/221/7276

As Constructed

No. Revisions:
 Revised:
 Void:

US 85 CROSS SECTIONS

Designer: DAF
 Detailer: DAF
 Sheet Subset: Roadway
 Subsets: _____ of _____

Project No./Code

NH 0852-086
 13429
 Sheet Number: 45C

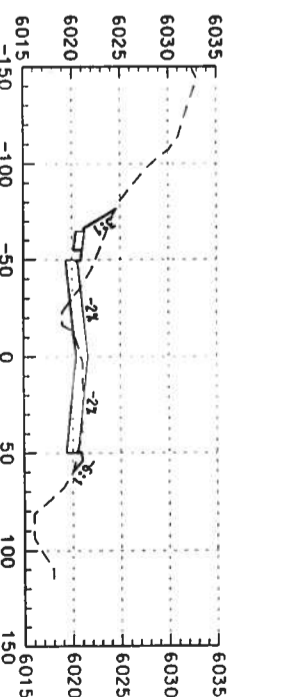
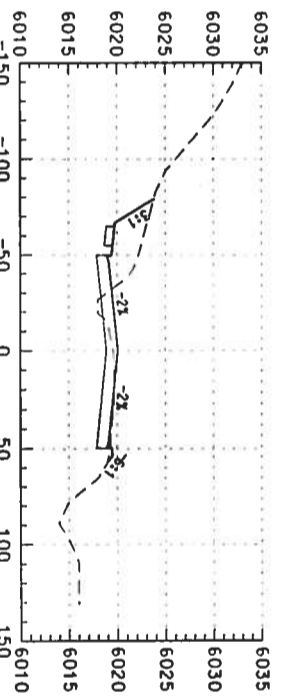
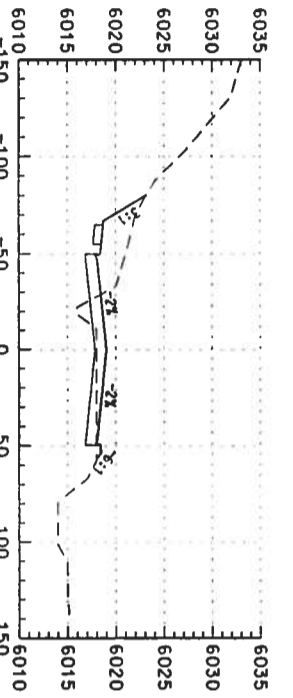
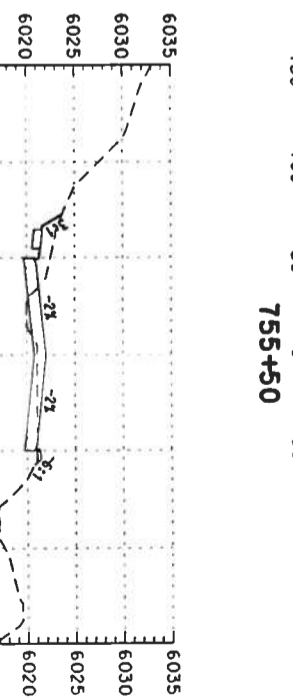
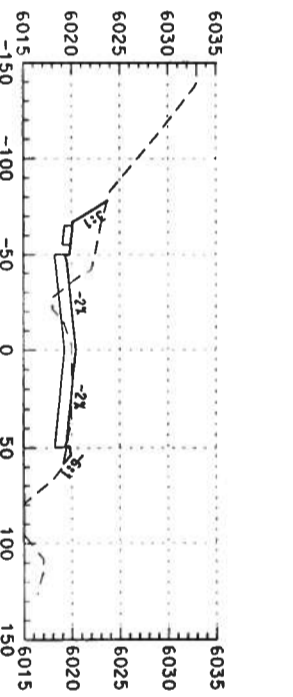
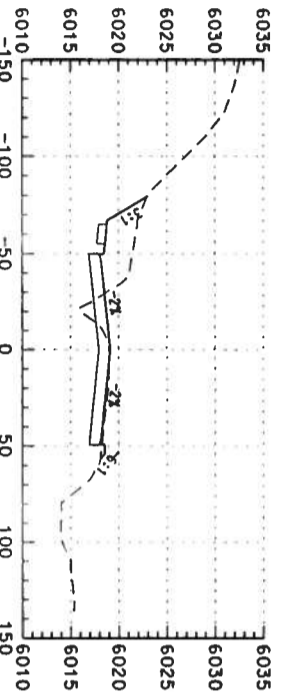
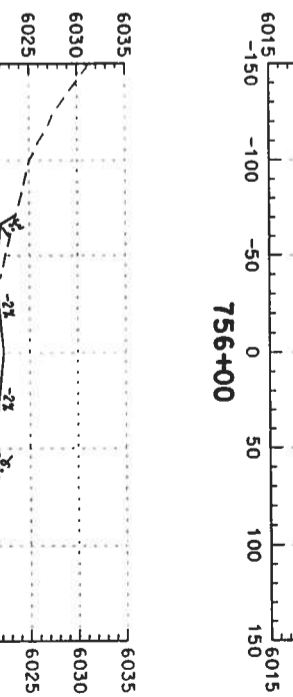
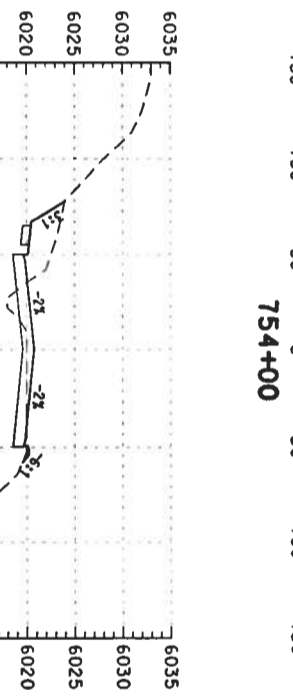
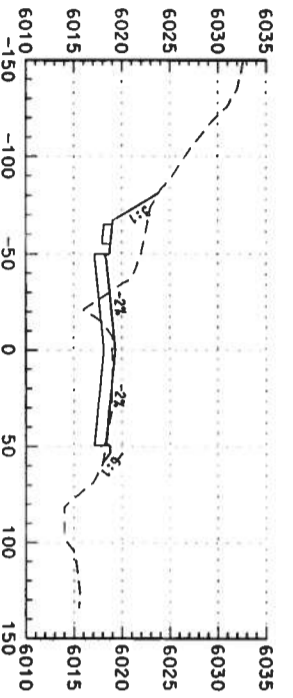
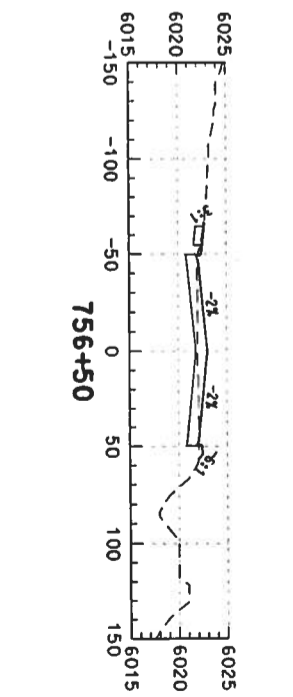
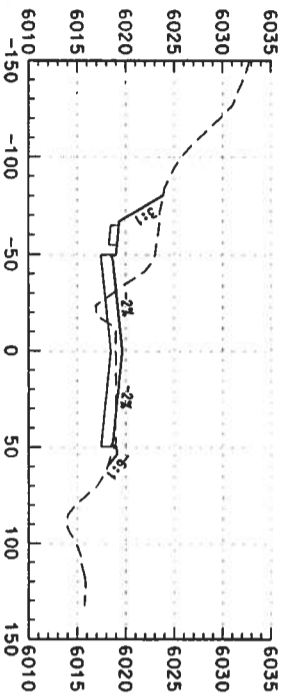

Computer File Information

Creation Date: 02/14/03 Initials: DAF
 Last Modification Date: Initials:
 Full Path: S:\Transport\246042.12\HwyDes\Plans\
 Drawing File Name: rdxs-so-2d152.dgn
 Scale: Units: ENGLISH

Index of Revisions

DOT
 DEPARTMENT OF TRANSPORTATION
 REGION 1

359 Inverness Dr. South
 Suite K
 Englewood, CO 80112
 Phone: (303) 790-1020
 Fax: (303) 790-1037

PBS&J
 5500 Greenwood Plaza Blvd.
 Suite 150
 Greenwood Village, CO 80111
 Phone: 303/221-7275
 Fax: 303/221/7276

As Constructed



No. Revisions:	
Revised:	
Void:	

US 85 CROSS SECTIONS

Designer:	DAF	Structure	
Detailer:	DAF	Numbers	
Sheet Subset:	Roadway	Subset Sheets:	01

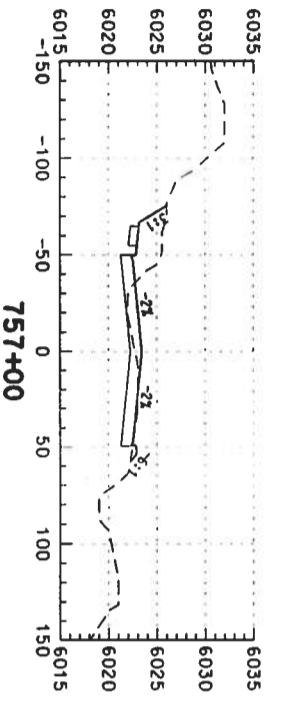
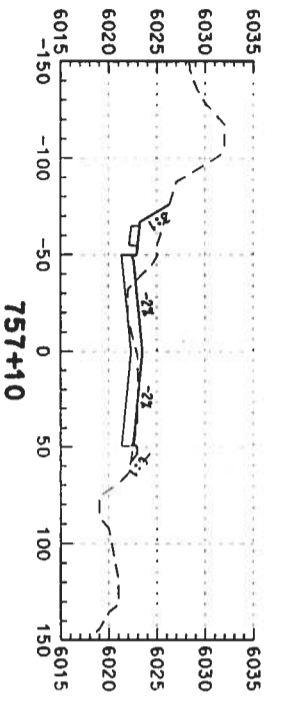
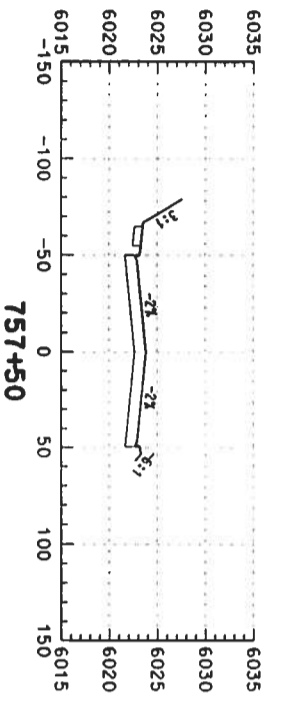
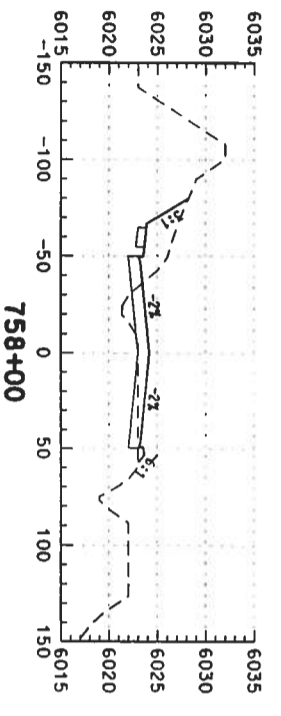
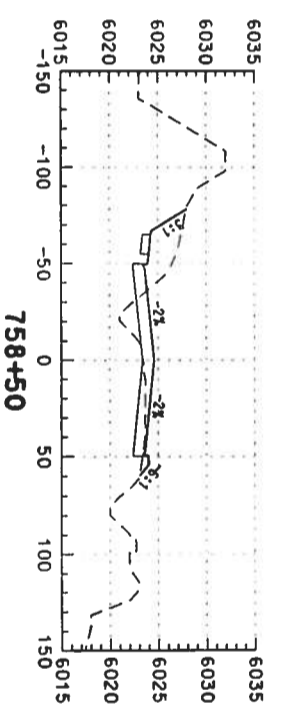
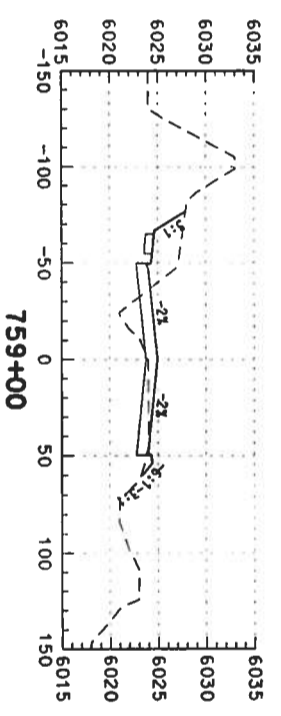
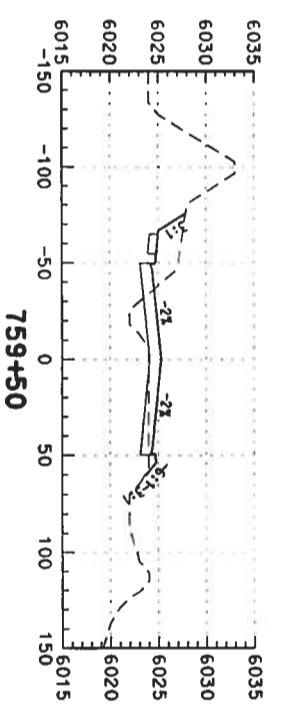
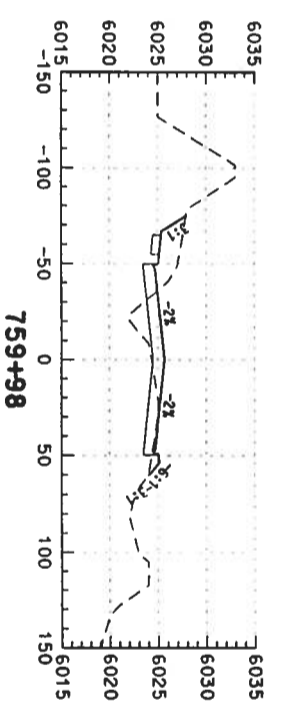
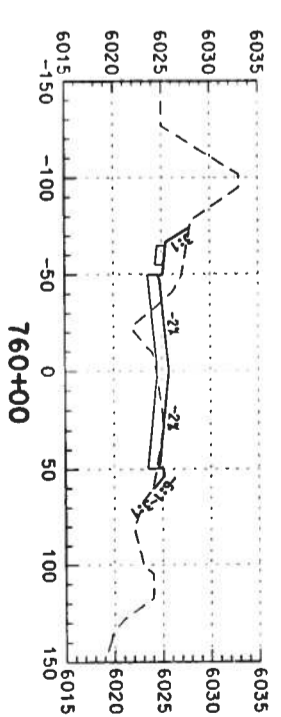
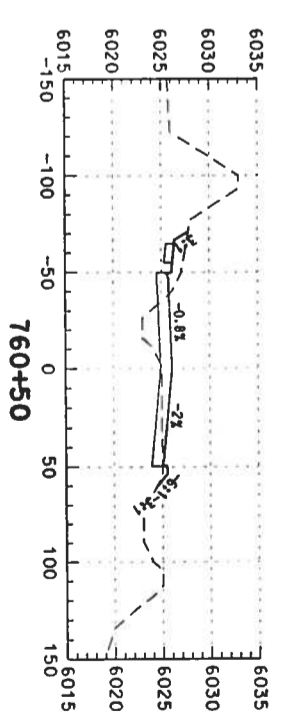
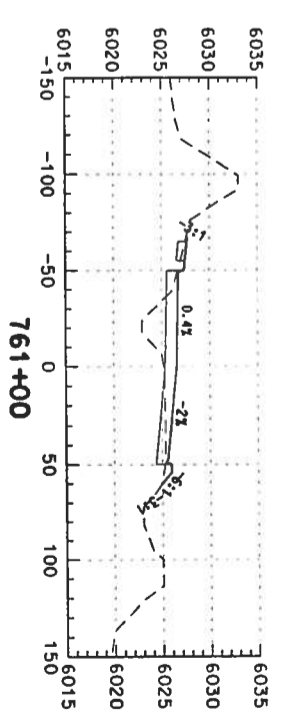
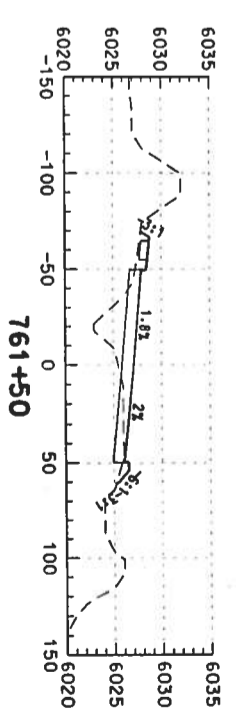
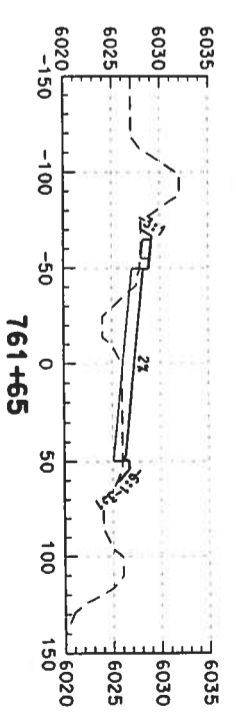
Project No./Cod
 NH 0852-086
 13429
 Sheet Number: 451



Computer File Information		Index of Revisions		REGION I		As Constructed		US 85 CROSS SECTIONS		Project No./Code			
Creation Date:	02/14/03	Initials:	DAF	 359 Inverness Dr. South Suite K Englewood, CO 80112 Phone: (303) 790-1020 Fax: (303) 790-1037		No. Revisions:		Designer: DAF Detailer: DAF Sheet Subset: Roadway		NH 0852-086			
Last Modification Date:		Initials:				Revised:				Structure Numbers		13429	
Full Path:	S:\Transport\246042\2\HwyDes\Plans\					Void:				Subset Sheets:		of	
Drawing File Name:	rdks-so-2d153.dgn												
Scale:	Units: ENGLISH			 5500 Greenwood Plaza Blvd. Suite 150 Greenwood Village, CO 80111 Phone: 303/221-7275 Fax: 303/221/7276						Sheet Number: 452			

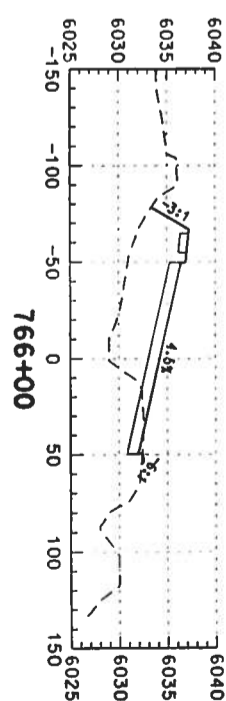
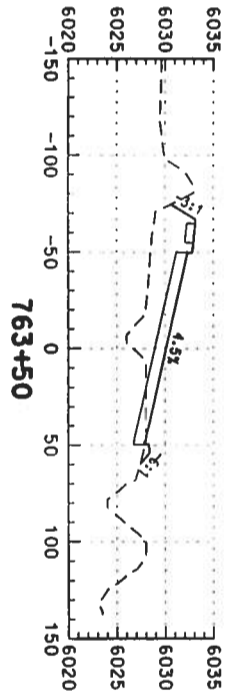
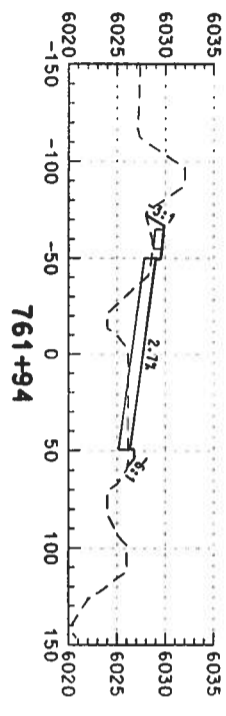
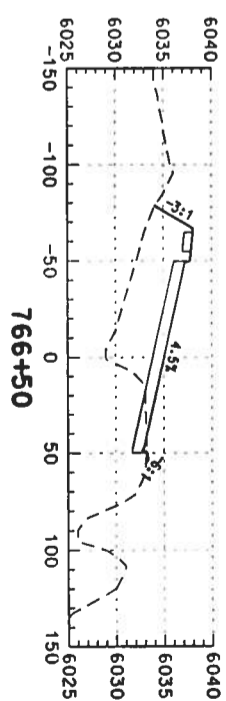
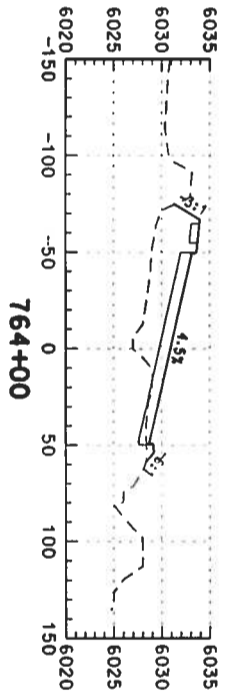
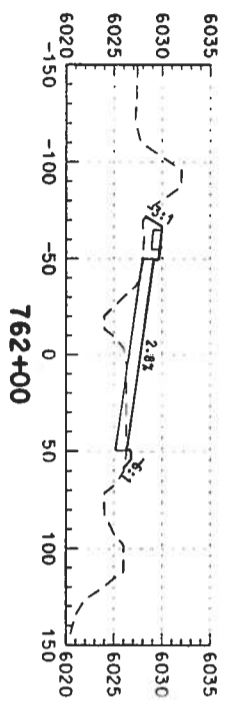
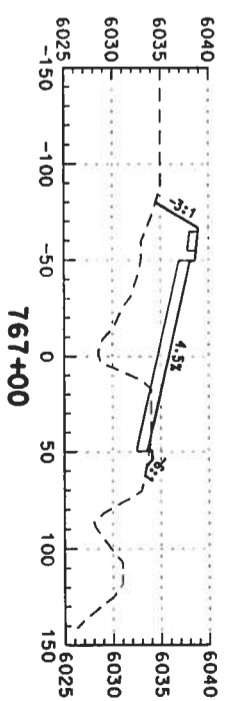
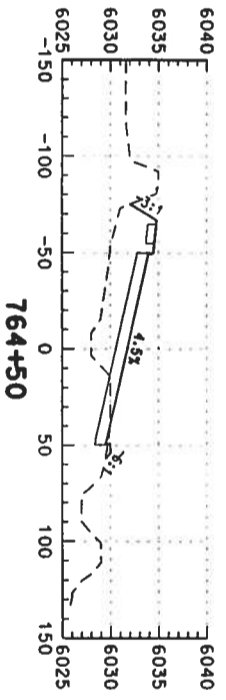
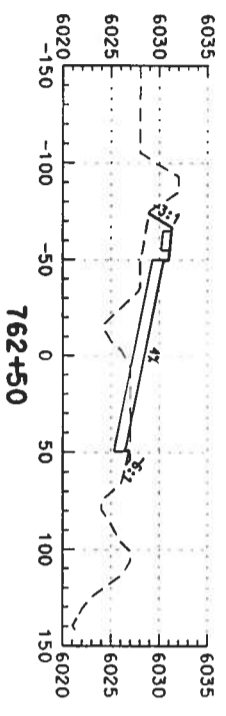
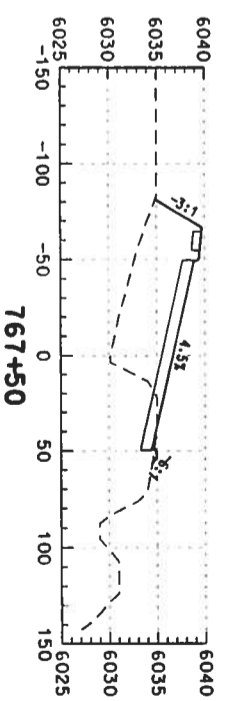
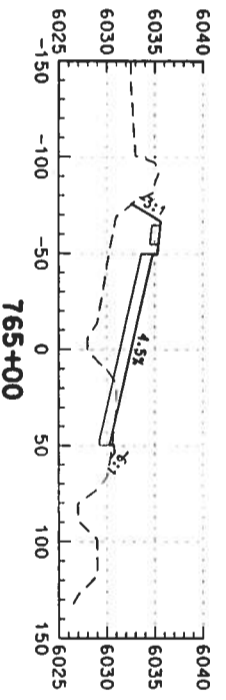
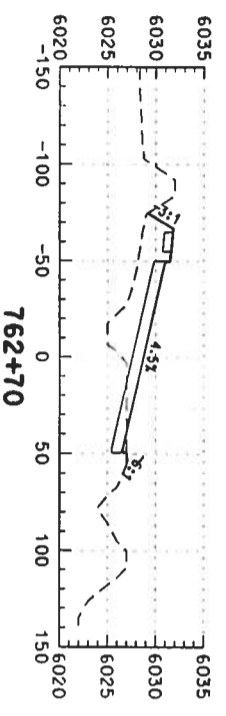
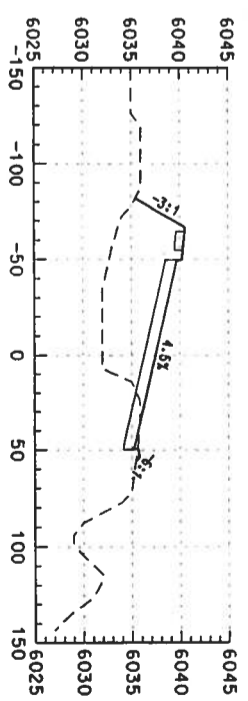
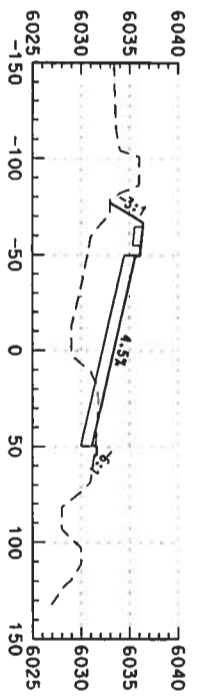
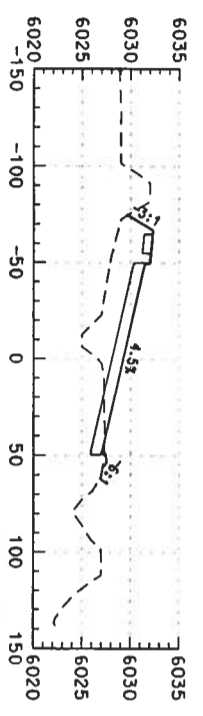

Computer File Information

Creation Date: 02/14/03
 Last Modification Date: 02/14/03
 Full Path: S:\Transport\246042\HWYDes\Plans\
 Drawing File Name: rdxs-so-2d154.dgn
 Scale: Units: ENGLISH

Index of Revisions



359 Inverness Dr. South
 Suite K
 Englewood, CO 80112
 Phone: (303) 790-1020
 FAX: (303) 790-1037



5500 Greenwood Plaza Blvd.
 Suite 150
 Greenwood Village, CO 80111
 Phone: 303/221-7275
 Fax: 303/221/7276

As Constructed

No. Revisions:
 Revised:
 Void:

US 85 CROSS SECTIONS

Designer: DAF
 Detailer: DAF
 Sheet Subset: Roadway
 Subsets: _____ of _____

Project No./Cod

NH 0852-086
 13429
 Sheet Number: 45

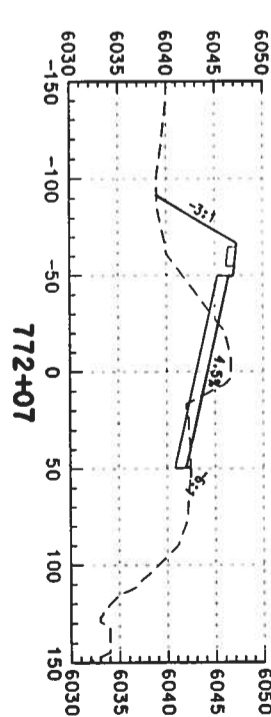
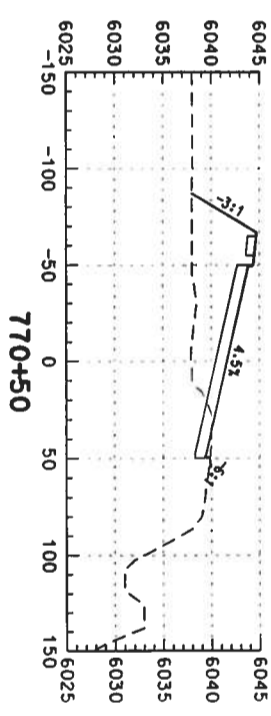
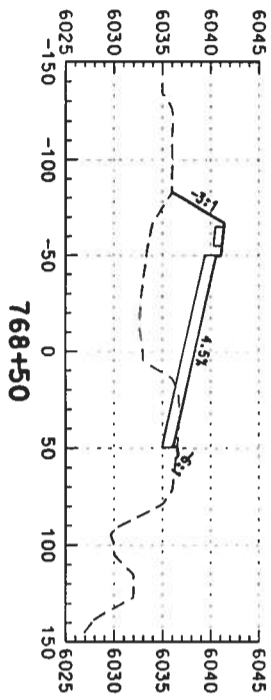
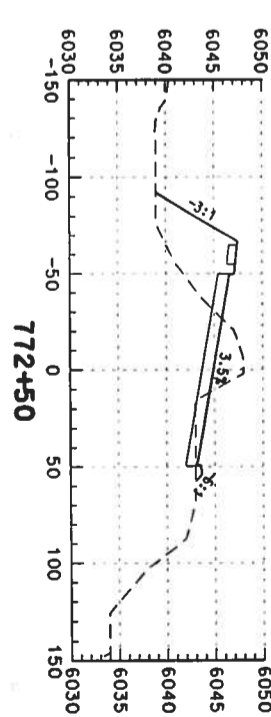
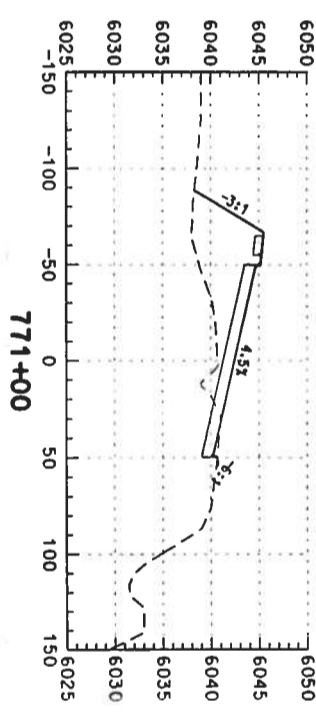
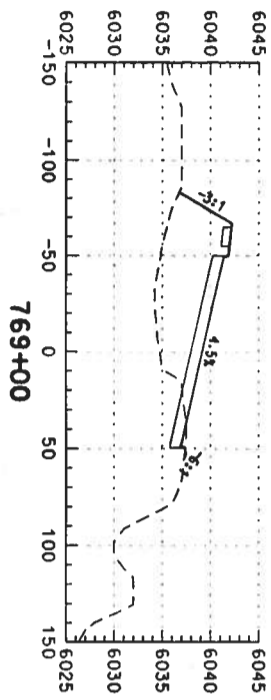
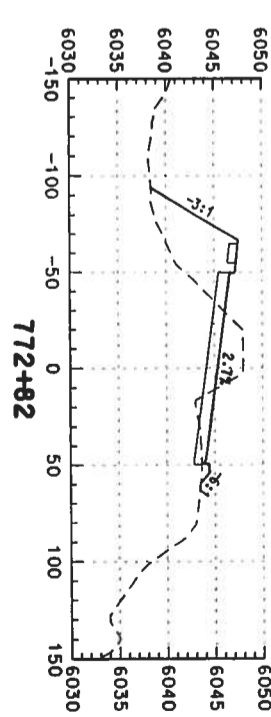
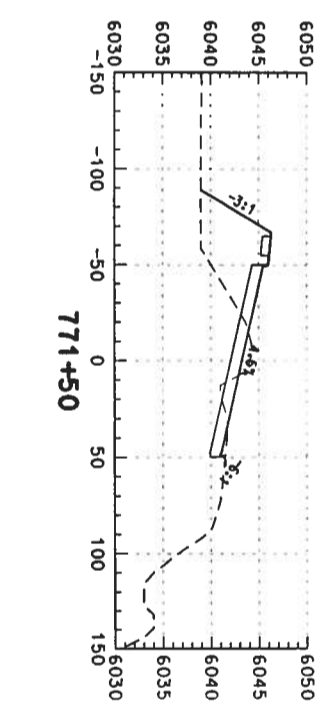
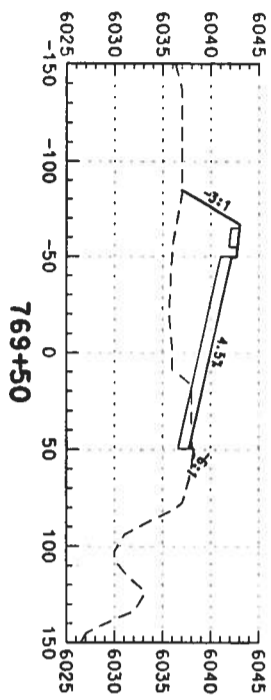
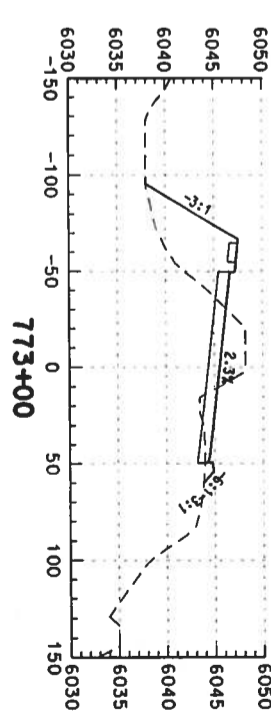
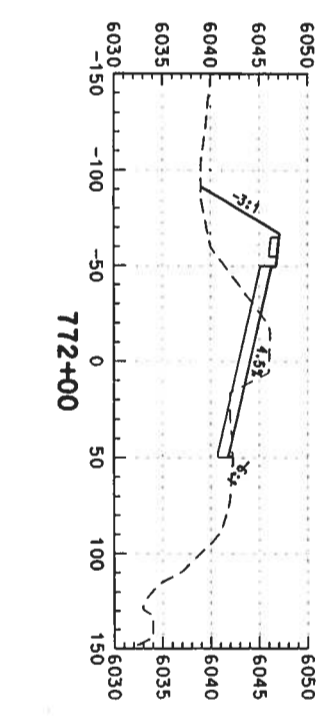
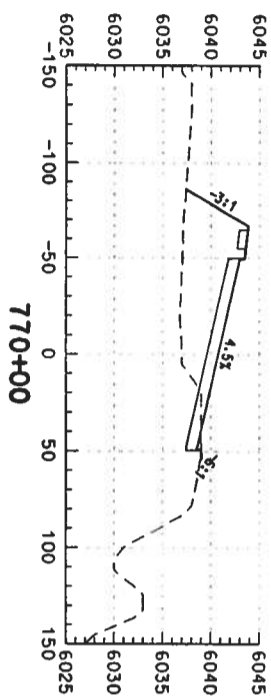

Computer File Information

Creation Date: 02/14/03 Initials: DAF
 Last Modification Date: Initials:
 Full Path: S:\Tranproj\246042\HwyDes\Plans\
 Drawing File Name: rdxs-so-2d155.dgn
 Scale: Units: ENGLISH

Index of Revisions



359 Inverness Dr. South
 Suite K
 Englewood, CO 80112
 Phone: (303) 790-1020
 FAX: (303) 790-1037

REGION 1



5500 Greenwood Plaza Blvd.
 Suite 150
 Greenwood Village, CO 80111
 Phone: 303/221-7275
 Fax: 303/221-7276

As Constructed

No. Revisions:
 Revised:
 Void:

US 85 CROSS SECTIONS

Designer: DAF Structure
 Detaller: DAF Numbers
 Sheet Subset: Roadway Subset Sheets: of

Project No./Cod

NH 0852-086
 13429
 Sheet Number: 452

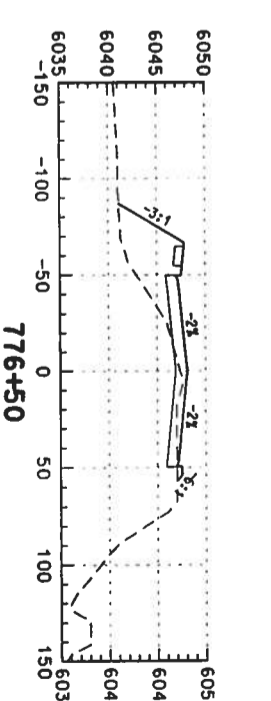
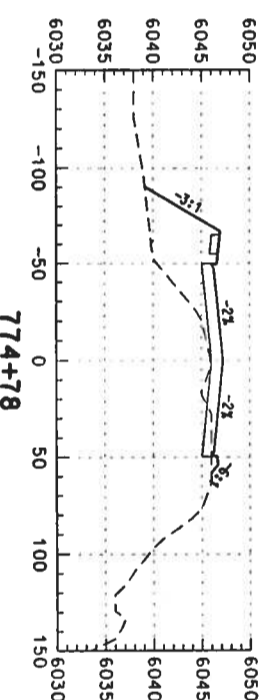
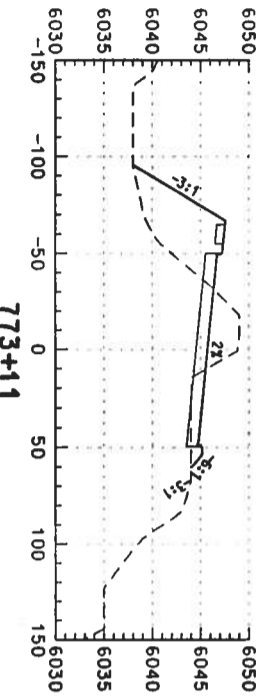
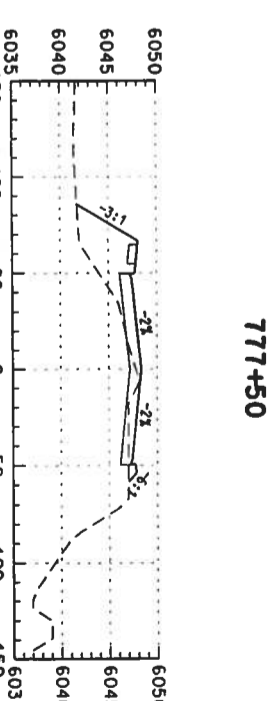
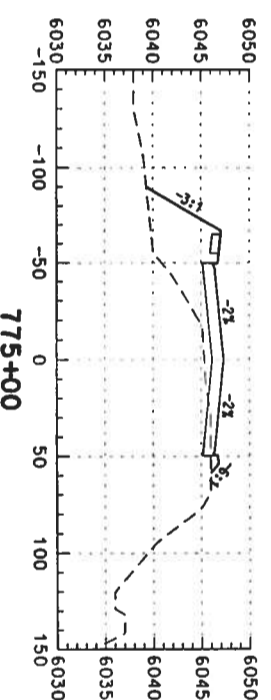
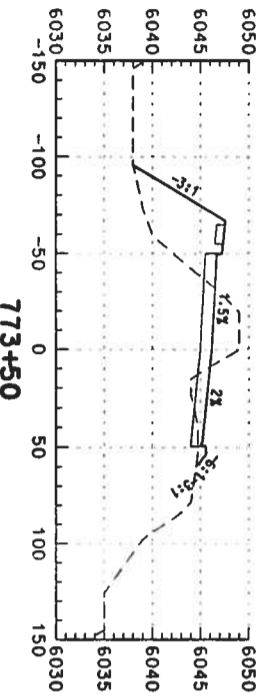
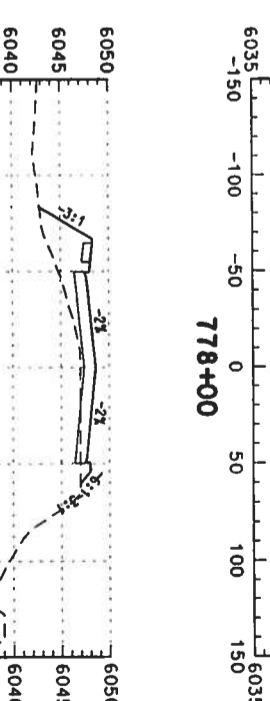
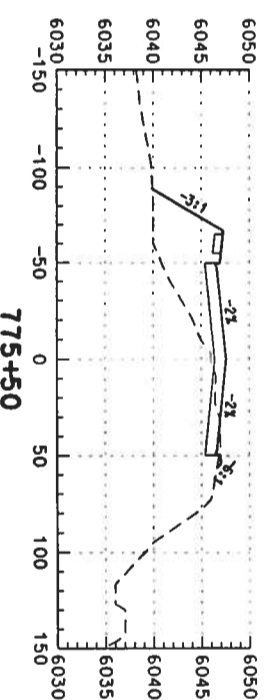
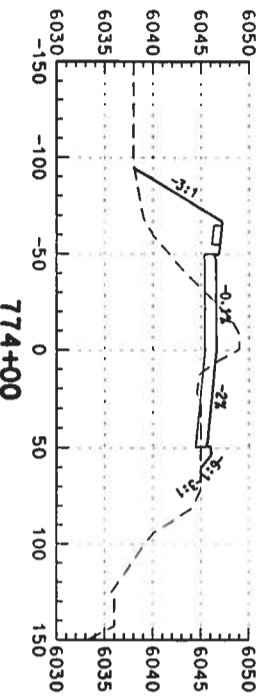
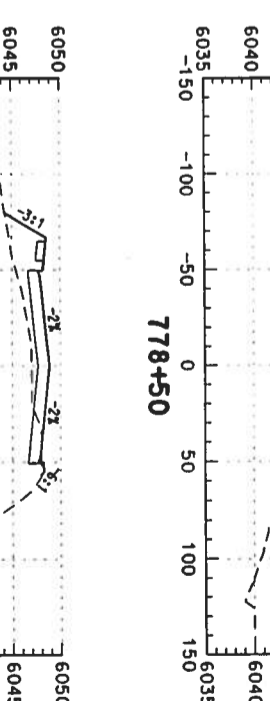
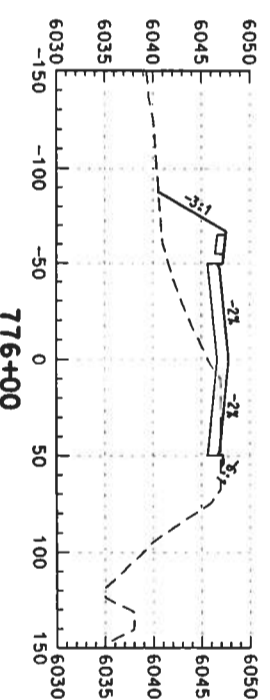
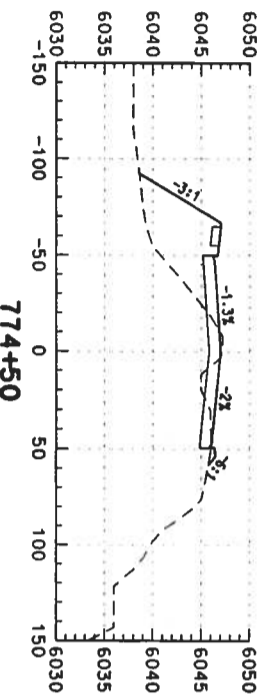

Computer File Information

Creation Date: 02/14/03 Initials: DAF
 Last Modification Date: Initials:
 Full Path: S:\Tranpro\246042\HwyDes\Plans\
 Drawing File Name: rdx-so-2d156.dgn
 Scale: Units: ENGLISH

Index of Revisions



359 Inverness Dr. South
 Suite K
 Englewood, CO 80112
 Phone: (303) 790-1020
 FAX: (303) 790-1037

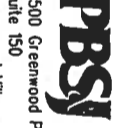

5500 Greenwood Plaza Blvd.
 Suite 150
 Greenwood Village, CO 80111
 Phone: 303/221-7275
 Fax: 303/221/7276

As Constructed

No. Revisions:
 Revised:
 Void:

US 85 CROSS SECTIONS

Designer: DAF
 Detailer: DAF
 Sheet Subset: Roadway
 Sub-sheet Numbers: of

Project No./Code

NH 0852-086
 13429
 Sheet Number: 455

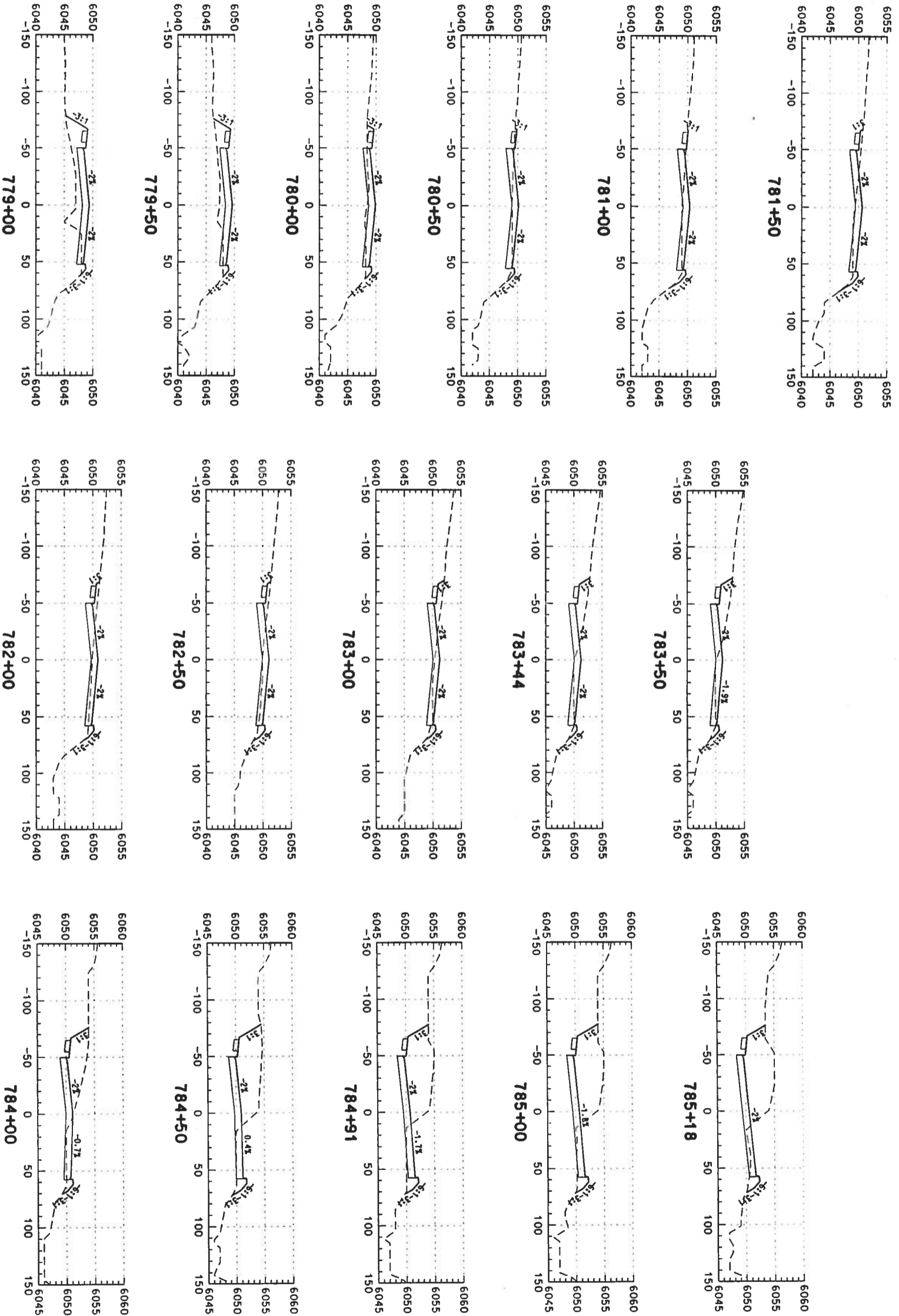

Computer File Information

Creation Date: 02/14/03
 Last Modification Date: 02/14/03
 Full Path: S:\Temp\proj\246042.12\HW\Des\Plans\
 Drawing File Name: rdxs-so-24157.dgn
 Scale: ENGLISH

Index of Revisions



DOT
DEPARTMENT OF TRANSPORTATION



PBSI

359 Inverness Dr. South
 Suite K
 Englewood, CO 80112
 Phone: (303) 790-1020
 Fax: (303) 790-1037

5500 Greenwood Plaza Blvd.
 Suite 150
 Greenwood Village, CO 80111
 Phone: 303/221-7275
 Fax: 303/221-7276

As Constructed

No. Revisions:
 Revised:
 Void:

US 85 CROSS SECTIONS

Designer: DAF
 Detailer: DAF
 Sheet Subset: Roadway
 Subsets:
 of

Project No./Cod

NH 0852-086
 13429
 Sheet Number: 456

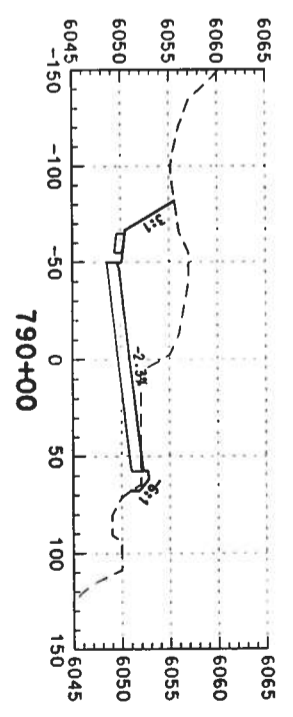
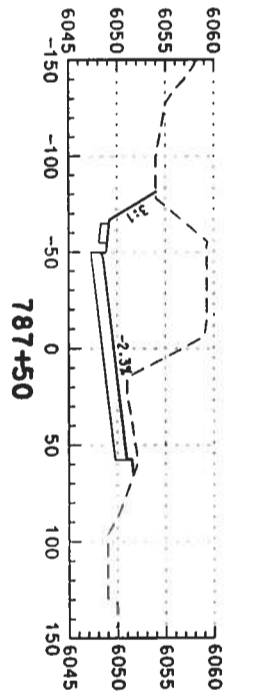
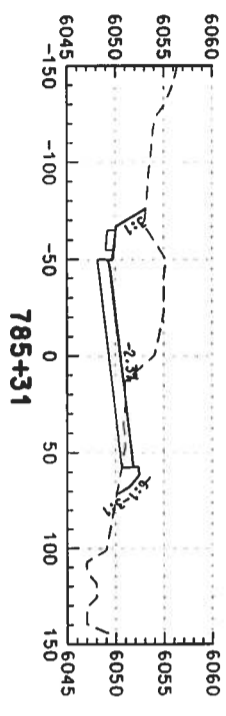
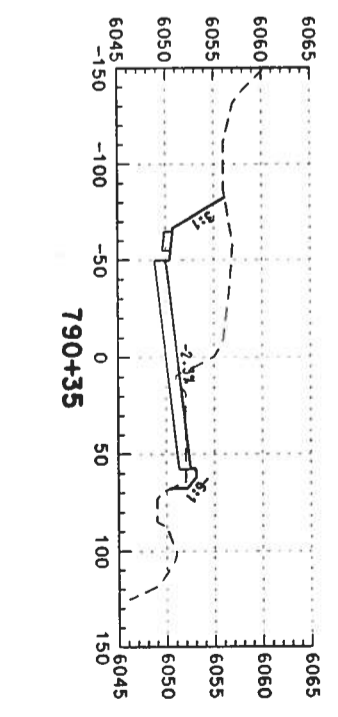
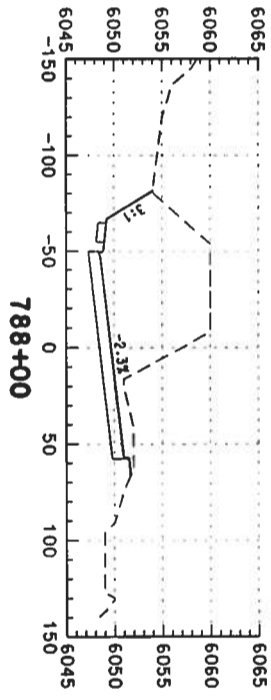
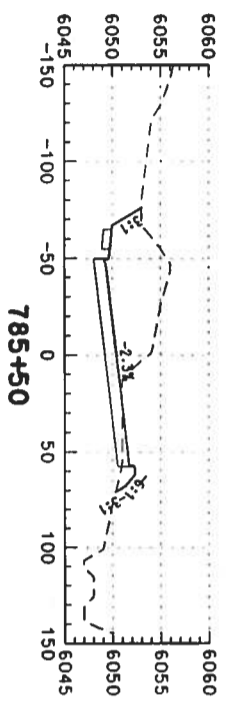
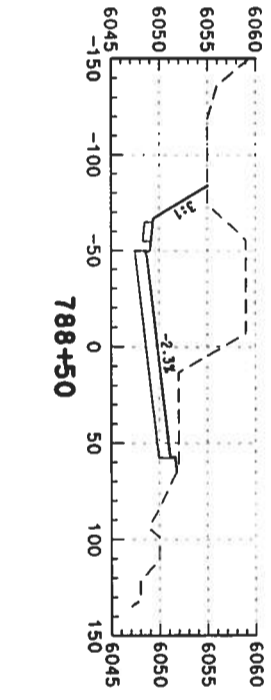
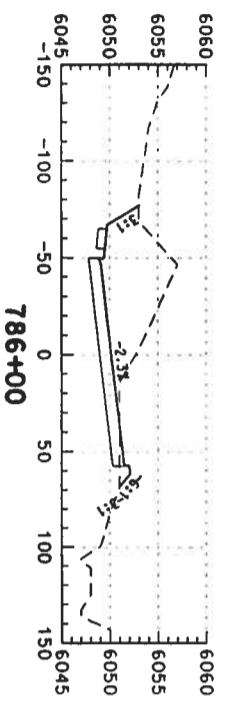
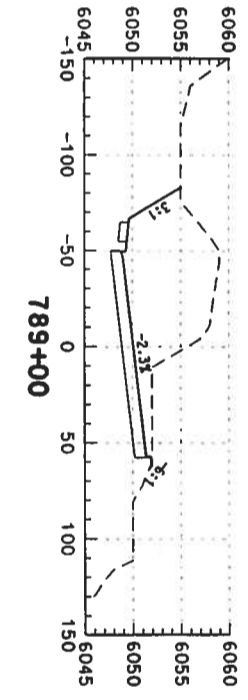
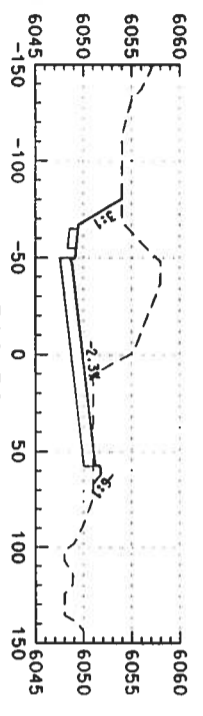
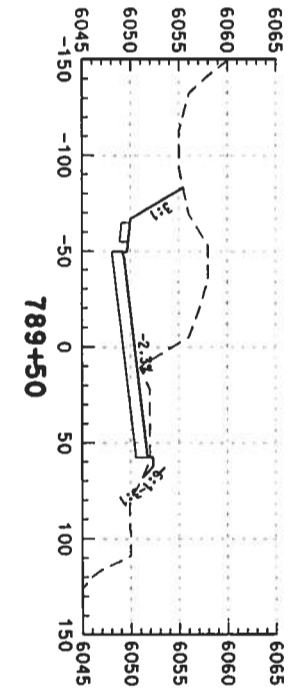
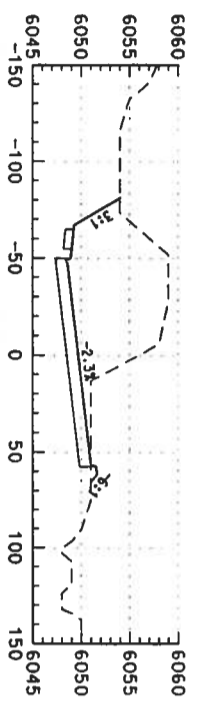

Computer File Information

Creation Date: 02/14/03 Initials: DAF
 Last Modification Date: Initials:
 Full Path: S:\Temp\o\246042\246042\HwyDes\Plans\
 Drawing File Name: rdxs-so-2d158.dgn
 Scale: Units: ENGLISH

Index of Revisions



359 Inverness Dr. South
 Suite K
 Englewood, CO 80112
 Phone: (303) 790-1020
 FAX: (303) 790-1037



5500 Greenwood Plaza Blvd.
 Suite 150
 Greenwood Village, CO 80111
 Phone: 303/221-7275
 Fax: 303/221-7276

As Constructed

No. Revisions: _____
 Revised: _____
 Void: _____

US 85 CROSS SECTIONS

Designer: DAF
 Detailer: DAF
 Sheet Subset: Roadway
 Subset Sheets: _____ of _____

Project No./Cod

NH 0852-086
 13429
 Sheet Number: 45

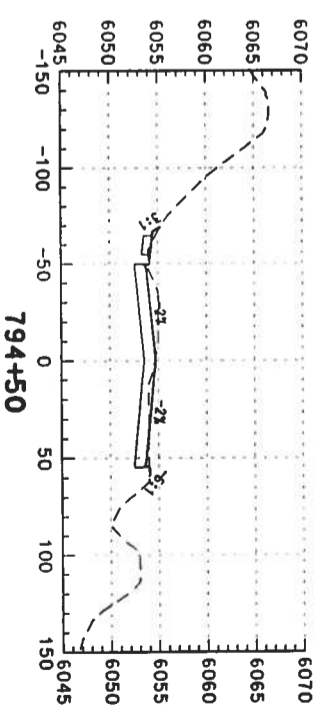
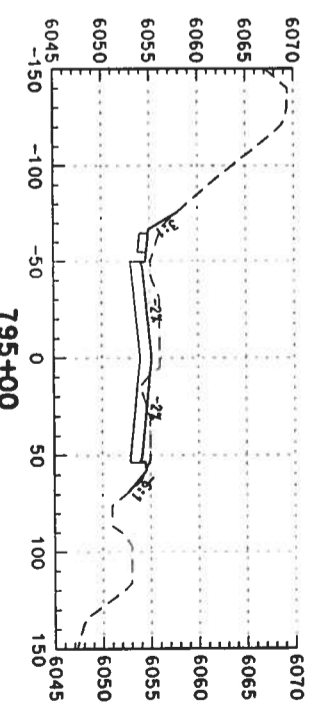
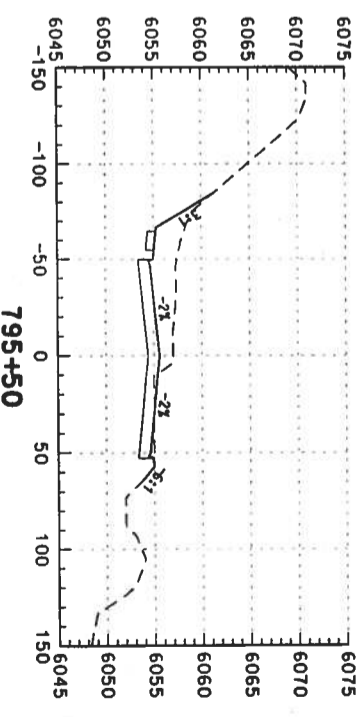
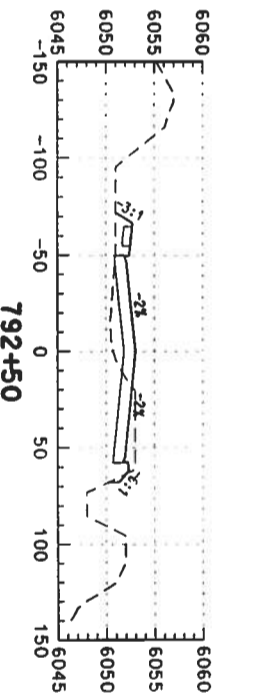
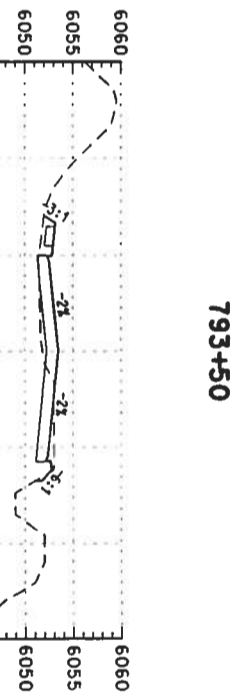
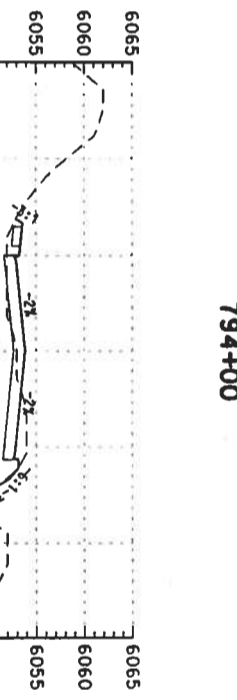
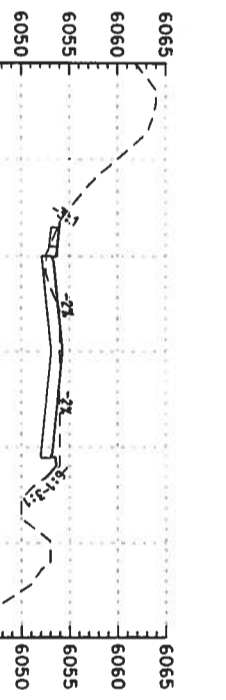
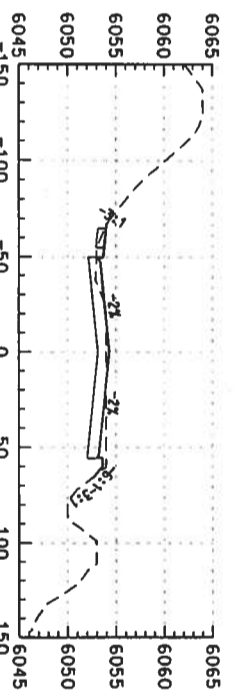
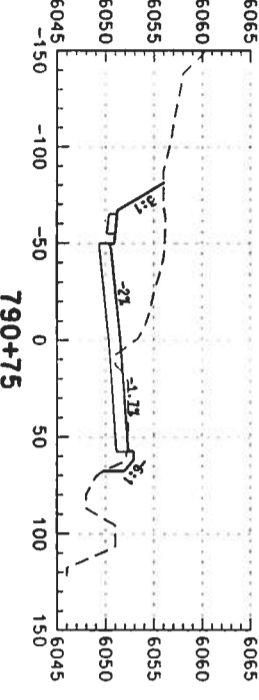
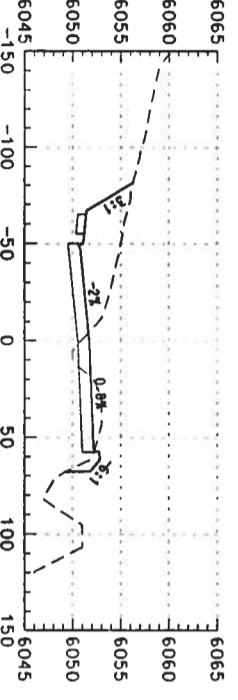
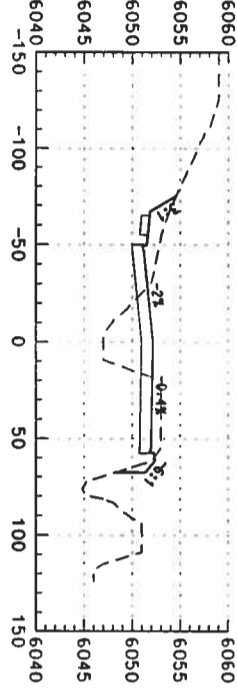
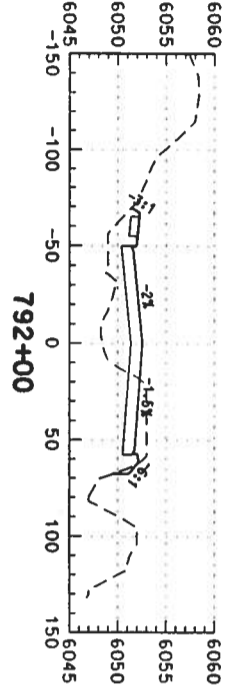
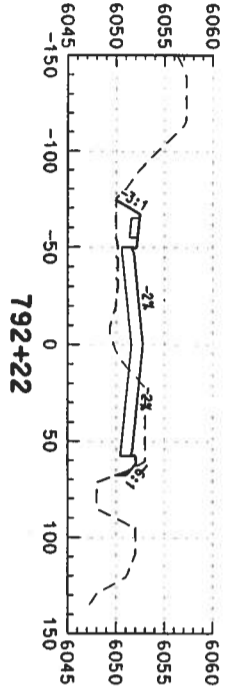

Computer File Information

Creation Date: 02/14/03 Initials: DAF
 Last Modification Date: Initials:
 Full Path: S:\Tranproj\246042\HW\Des\Plans\
 Drawing File Name: rdxs-so-24159.dgn
 Scale: Units: ENGLISH

Index of Revisions



359 Inverness Dr. South
 Suite K
 Englewood, CO 80112
 Phone: (303) 790-1020
 Fax: (303) 790-1037



5500 Greenwood Plaza Blvd.
 Suite 150
 Greenwood Village, CO 80111
 Phone: 303/721-7275
 Fax: 303/721/7276

As Constructed

No. Revisions:	
Revised:	
Void:	

US 85 CROSS SECTIONS

Designer:	DAF
Detailer:	DAF
Sheet Subset:	Roadway
Structure Numbers:	
Subset Sheets:	
of	

Project No./Cod

NH 0852-086
 13429
 Sheet Number: 458

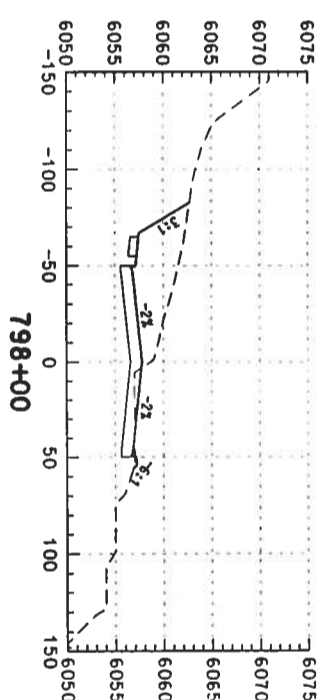
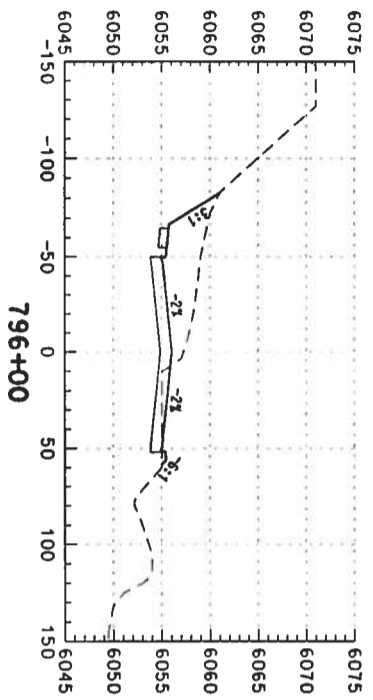
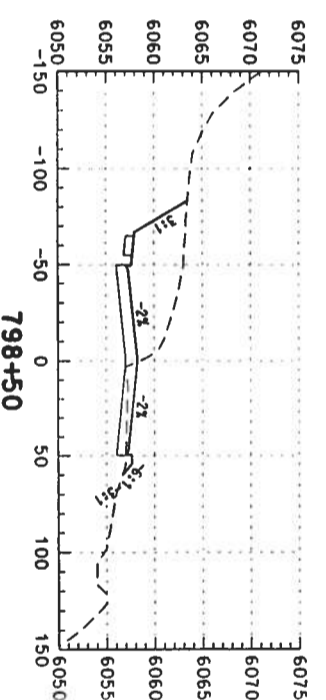
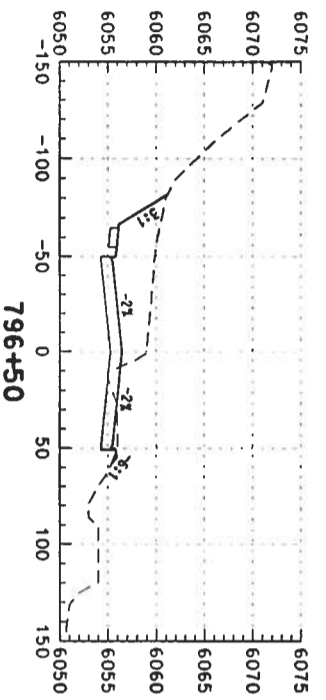
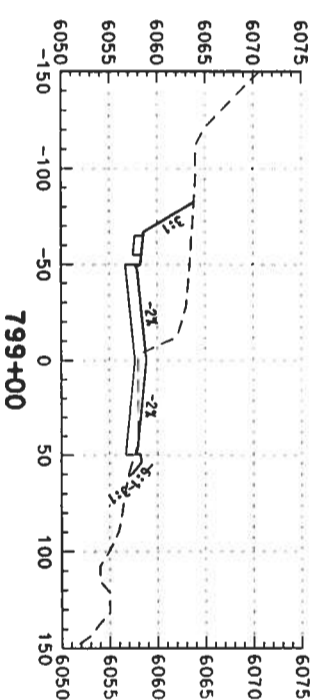
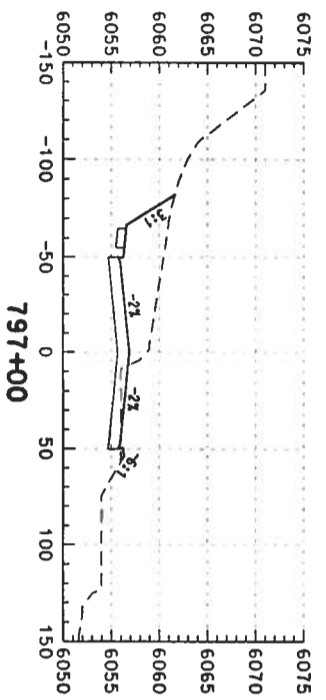
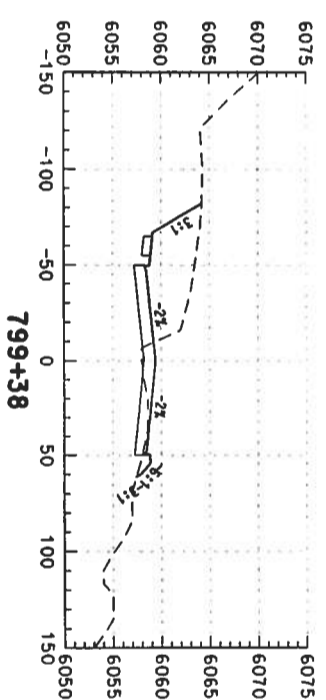
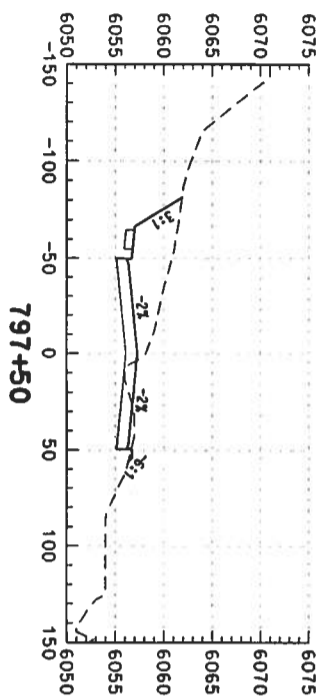

Computer File Information

Creation Date: 02/14/03 Initials: DAF
 Last Modification Date: Initials:
 Full Path: S:\Tranpro\246042\HwyDes\Plans\
 Drawing File Name: rdxs-so-2d160.dgn
 Scale: Units: ENGLISH

Index of Revisions



359 Burreuss Dr., South
 Suite K
 Englewood, CO 80112
 Phone: (303) 790-1020
 FAX: (303) 790-1037



5500 Greenwood Plaza Blvd.
 Suite 150
 Greenwood Village CO 80111
 Phone: 303/221-7275
 Fax: 303/221-7276

As Constructed

No. Revisions:	
Revised:	
Void:	

US 85 CROSS SECTIONS

Designer:	DAF	Structure	
Detailer:	DAF	Numbers	
Sheet Subset:	Roadway	Subset Sheets:	

Project No./Cod

NH 0852-086
 13429
 Sheet Number: 459

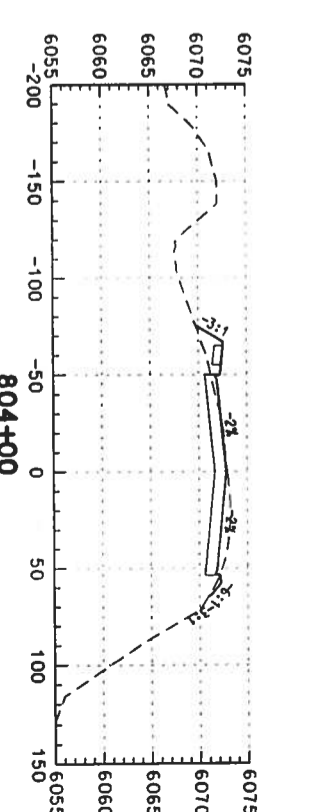
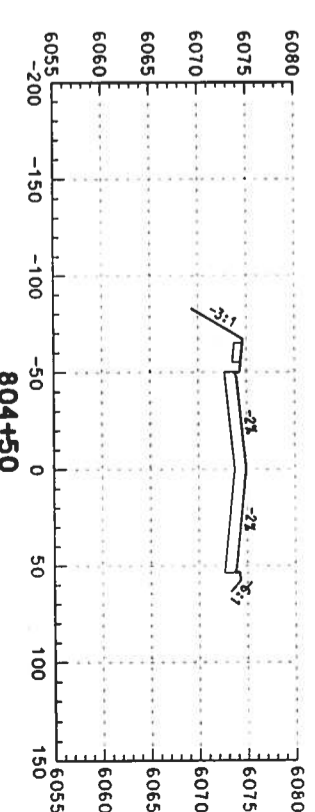
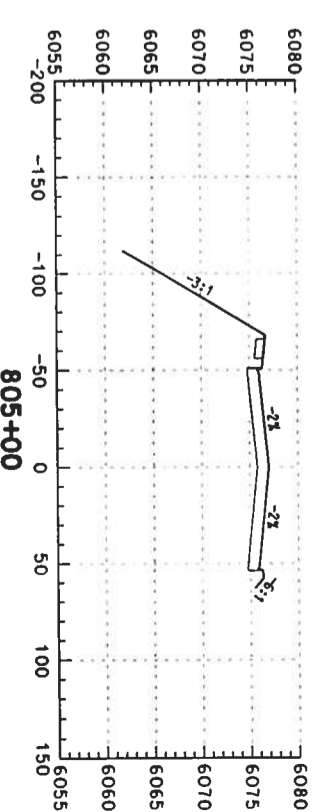
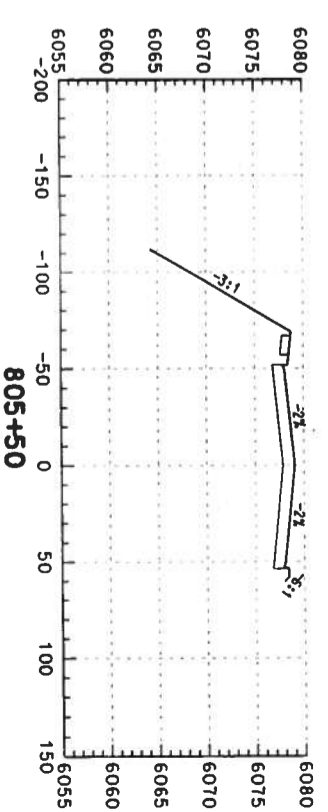
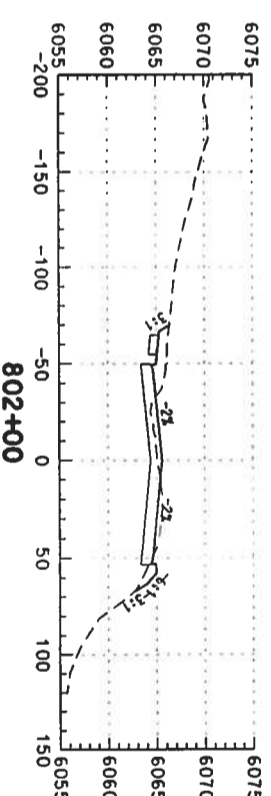
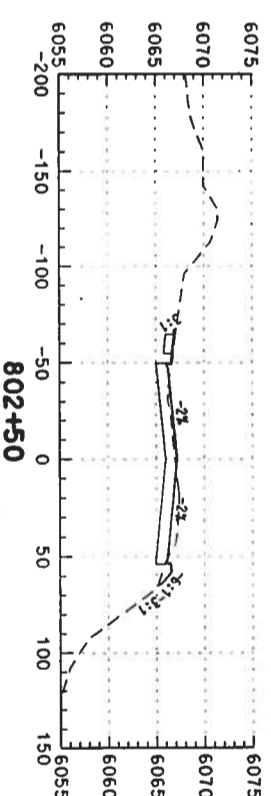
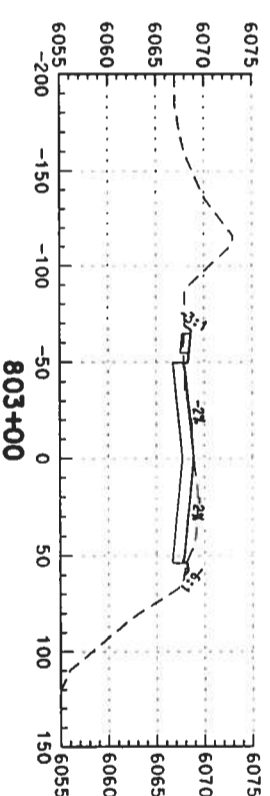
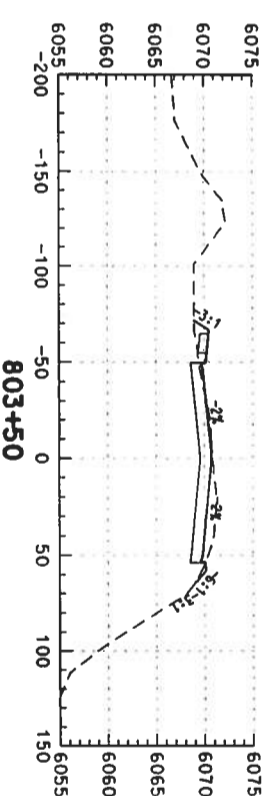
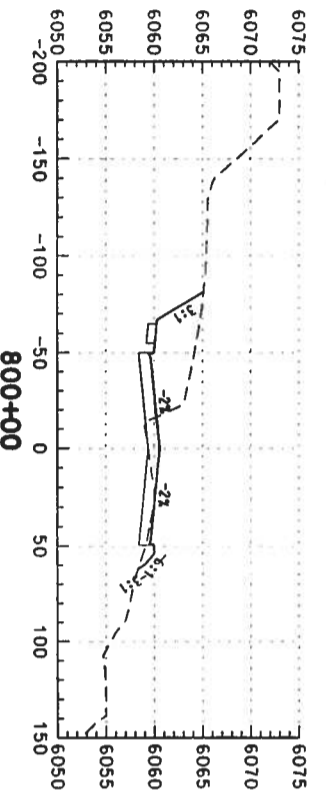
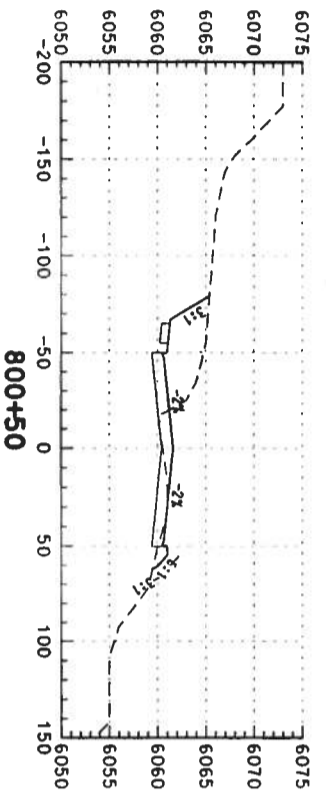
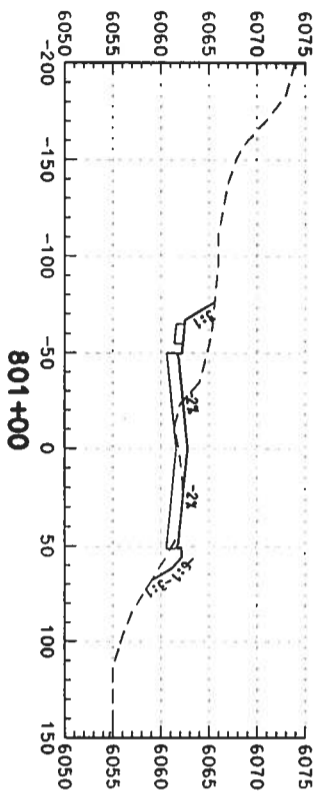
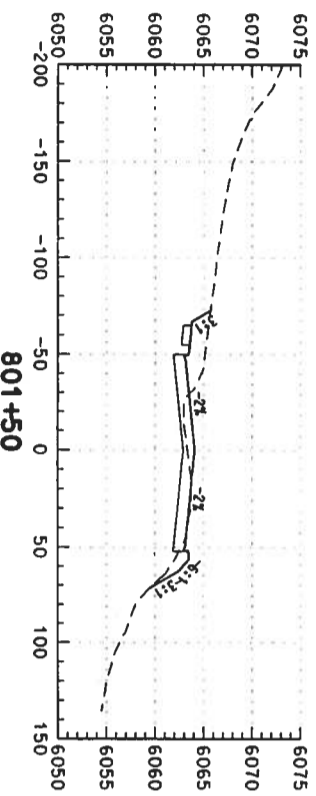

Computer File Information

Creation Date: 02/14/03 Initials: DAF
 Last Modification Date: Initials:
 Full Path: S:\Tranproj\246042\2\HwyDes\Plans\
 Drawing File Name: rdxs-so-2d161.dgn
 Scale: Units: ENGLISH

Index of Revisions



359 Inverness Dr. South
 Suite K
 Englewood, CO 80112
 Phone: (303) 790-1020
 Fax: (303) 790-1037



5500 Greenwood Plaza Blvd.
 Suite 150
 Greenwood Village, CO 80111
 Phone: 303/221-7275
 Fax: 303/221/7276

As Constructed

No. Revisions:	
Revised:	
Void:	

US 85 CROSS SECTIONS

Designer:	DAF
Detailer:	DAF
Sheet Subset:	Roadway
Structure Numbers:	
Subset Sheets:	
of	

Project No./Code

NH 0852-086
 13429
 Sheet Number: *ABC*

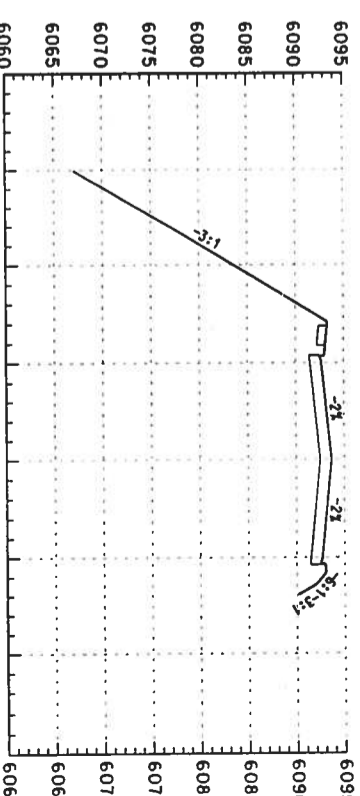
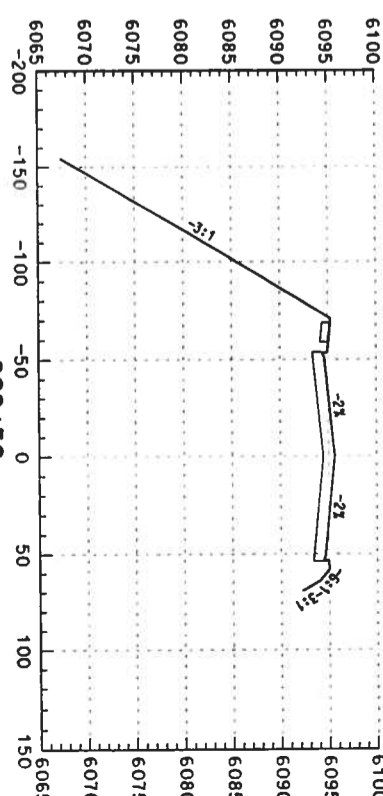
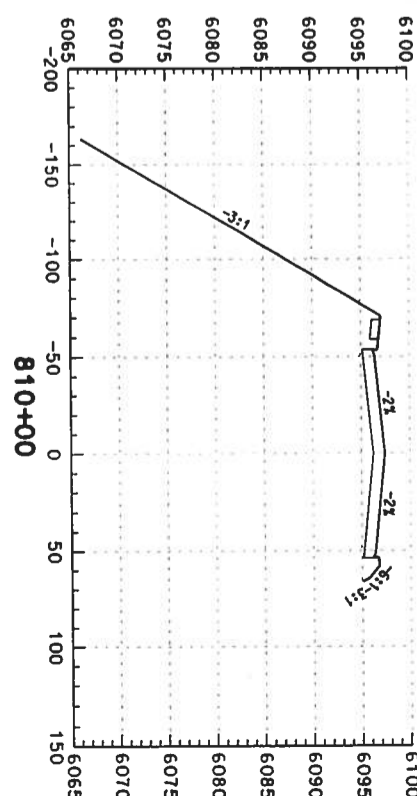
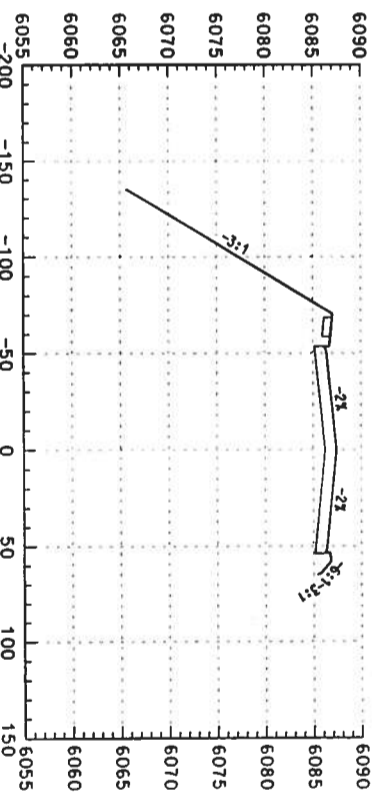
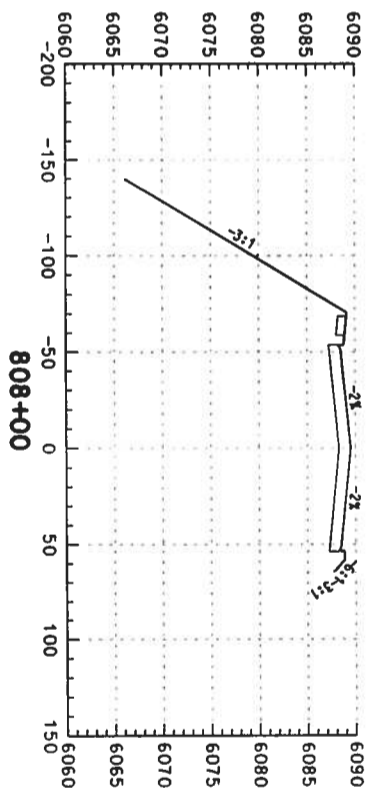
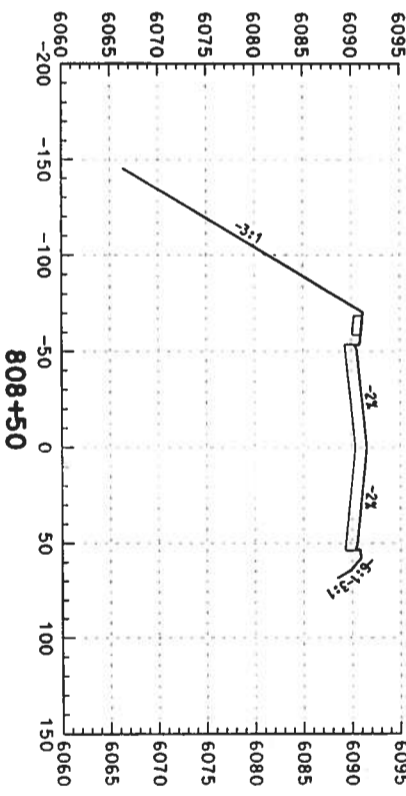
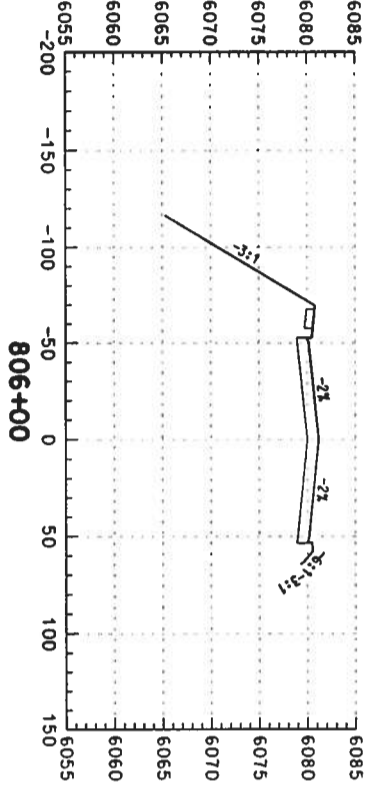
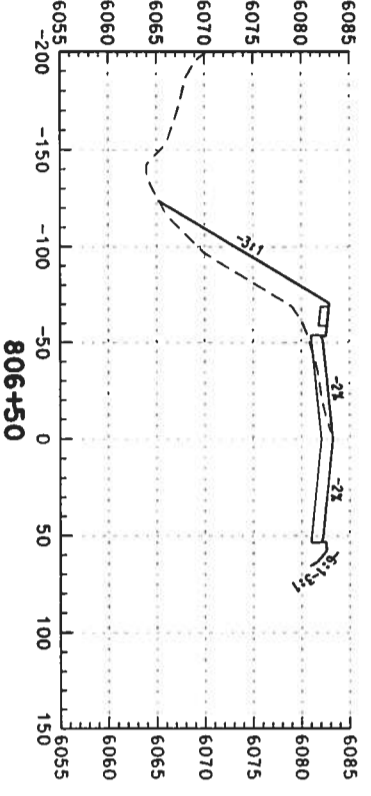
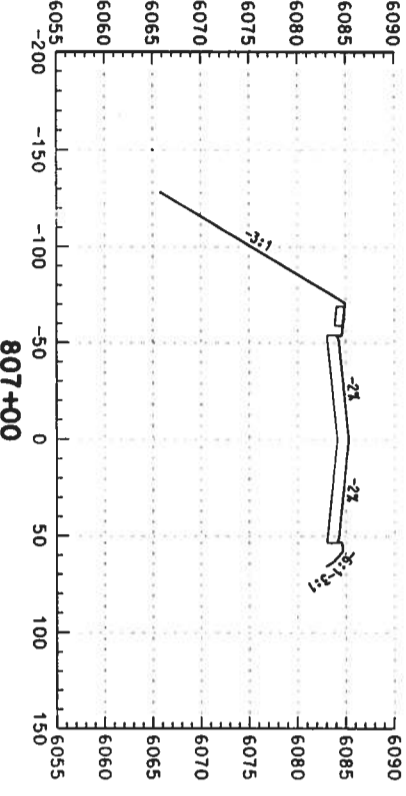

Computer File Information

Creation Date: 02/14/03 Initials: DAF
 Lost Modification Date: Initials:
 Full Path: S:\Transport\246042.12\HwyDes\Plans\
 Drawing File Name: rdxs-so-2d162.dgn
 Scale: Units: ENGLISH

Index of Revisions



359 Inverness Dr. South
 Suite K
 Englewood, CO 80112
 Phone: (303) 790-1020
 Fax: (303) 790-1037



5500 Greenwood Plaza Blvd.
 Suite 150
 Greenwood Village, CO 80111
 Phone: 303/221-7275
 Fax: 303/221/7276

As Constructed

No. Revisions:	
Revised:	
Void:	

US 85 CROSS SECTIONS

Designer:	DAF
Detailer:	DAF
Sheet Subset:	Roadway
Structure Numbers:	
Subset Sheets:	
of	

Project No./Cod

NH 0852-086
 13429
 Sheet Number: 46

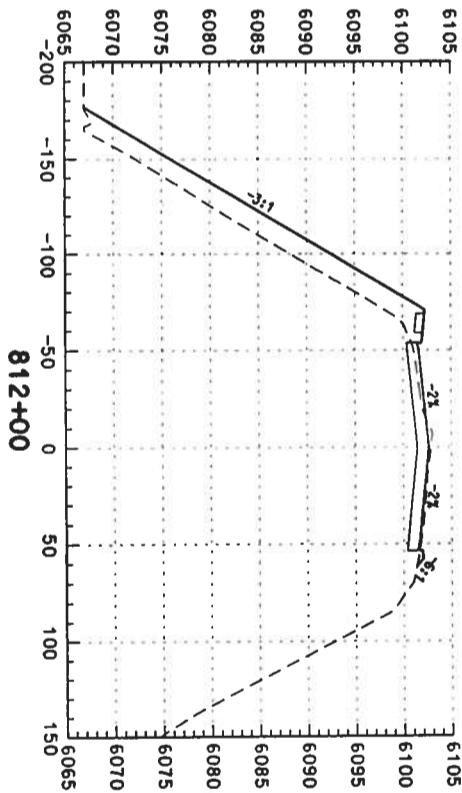
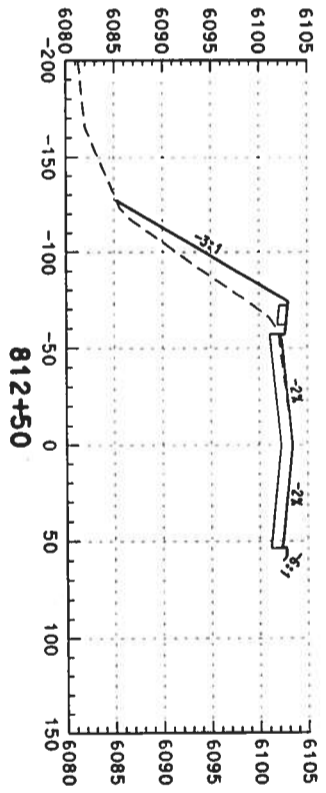
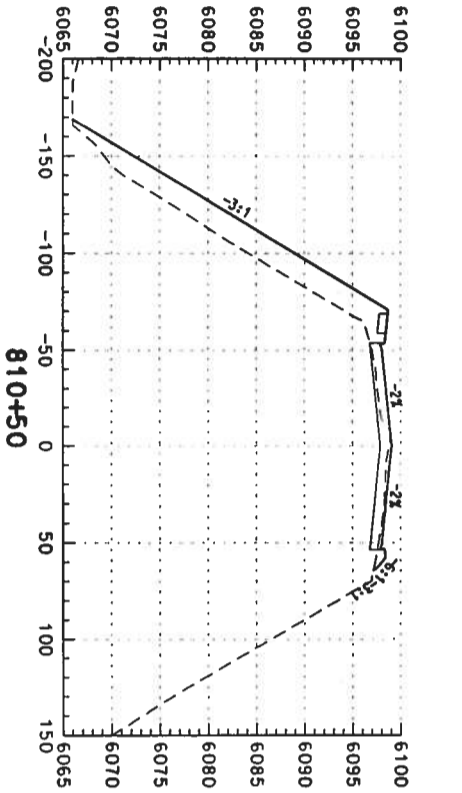
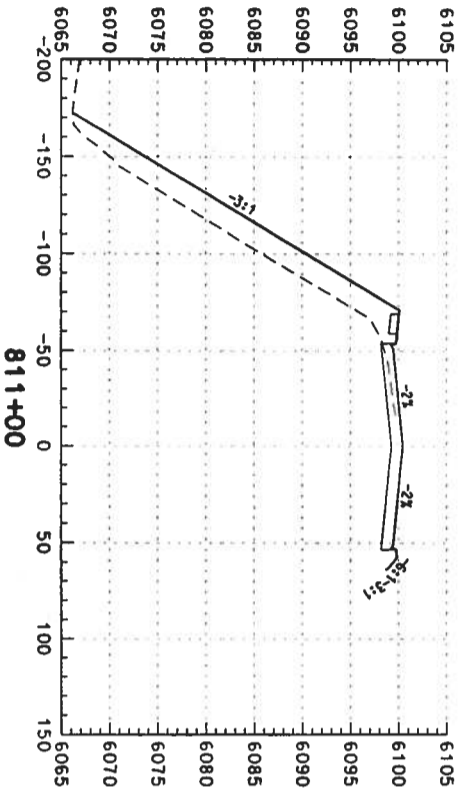
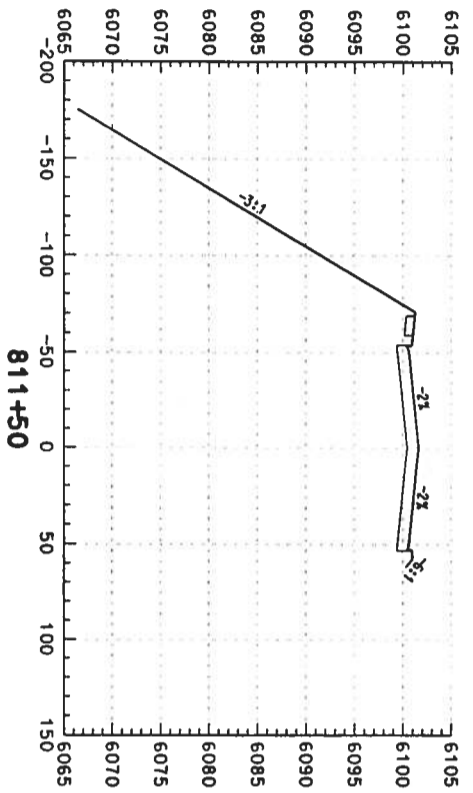

Computer File Information

Creation Date: 02/14/03 Initials: DAF
 Last Modification Date: Initials:
 Full Path: S:\Tranpro\246042.12\HwyDes\Plans\
 Drawing File Name: rdxs-so-24163.dgn
 Scale: Units: ENGLISH

Index of Revisions



359 Inverness Dr. South
 Suite K
 Englewood, CO 80112
 Phone: (303) 790-1020
 Fax: (303) 790-1037



5500 Greenwood Plaza Blvd.
 Suite 150
 Greenwood Village, CO 80111
 Phone: (303) 221-7275
 Fax: (303) 221-7276

As Constructed

No. Revisions:	
Revised:	
Void:	

US 85 CROSS SECTIONS

Designer:	DAF	Structure	
Detailer:	DAF	Numbers	
Sheet Subset:	Roadway	Subset Sheets:	

Project No./Cod

NH 0852-086
 13429
 Sheet Number: 402