



Chapter 13 Bicycle and Pedestrian Facilities

13.1	Introduction	1
13.1.1	CDOT Bike and Pedestrian Policy Directive 1602.0	2
13.1.2	CDOT Bike and Pedestrian Procedural Directive 1602.1	3
13.1.3	Design Exemptions	4
13.1.4	Federal Guidance Concerning Bicycle and Pedestrian Facilities	5
13.1.4.1	U.S. Department of Transportation (DOT) Policy Statement.....	5
13.1.4.2	Restrictions on Severing Bicycle and Pedestrian Facilities	5
13.1.5	Context Sensitive Solutions.....	6
13.1.6	User Counts	6
13.2	Bicycle Facilities.....	6
13.2.1	Bikeway Facility Selection.....	7
13.2.1.1	Bicyclist User Types.....	7
	<i>Figure 13-1 Bicyclist Design User Profiles</i>	<i>8</i>
	<i>Figure 13-2 Preferred Bikeway Type for Interested but Concerned Bicyclists in Rural Places (C2), Suburban Places (C3), Downtown Places (C5), and Urban Core (C6) Context Classifications.....</i>	<i>9</i>
	<i>Figure 13-3 Preferred Shoulder Widths for Rural Roadways.....</i>	<i>10</i>
13.2.2	On-Road Bicycle Facilities	10
13.2.2.1	Sharing Roadway Space	11
13.2.3	Additional Bicycle Facility Types	11
13.2.3.1	Role of Design Factors.....	11
	<i>Table 13-1 Bicycle Dimensions.....</i>	<i>13</i>
	<i>Table 13-2 Key Performance Criteria.....</i>	<i>14</i>
	<i>Figure 13-4 Summary of Expected Design Vehicles and Dimensions.....</i>	<i>15</i>
	<i>Figure 13-5 Bicycle Operating Space Requirements.....</i>	<i>16</i>
13.2.4	Bike Routes.....	16
13.2.4.1	General Routes	16
	<i>Figure 13-6 Examples of Bike Route Guide Signs</i>	<i>17</i>
13.2.4.2	Number Routes	17
	<i>Figure 13-7 Examples of Bike Route Signs</i>	<i>17</i>
	<i>Figure 13-8 U.S. Bike Route Sign</i>	<i>18</i>
13.2.5	Shared Lanes.....	18
13.2.5.1	Shared Lane Signage.....	19
	<i>Figure 13-9 May Use Full Lane Sign</i>	<i>19</i>



Figure 13-10 Bicycle 3-Foot Clearance Sign 20

Figure 13-11 Share the Road Sign Assembly 21

13.2.5.2 Shared Lane Markings..... 22

Figure 13-12 Shared Lane Marking 22

13.2.6 Paved Shoulders 22

13.2.6.1 Additional Width 23

Table 13-3 Maximum Motor Vehicle Service Volumes for Given Bicycle LOS Grades 24

Figure 13-13 Shoulder Widths to Accommodate Highly Confident Bicyclists on Rural Roadways 25

13.2.6.2 Shoulder Pavement Quality..... 25

13.2.6.3 Shoulders on Steep Grades 25

13.2.6.4 Rumble Strips 26

Figure 13-14 Advance Warning Stripe for Rumble Strips..... 26

13.2.6.5 Shoulders at Intersections 26

Figure 13-15 Bike Slot at Intersection..... 26

13.2.7 Bike Lanes 27

13.2.7.1 Bike Lane Width 27

Table 13-4 One-Way Standard Bike Lane Width Criteria..... 27

13.2.7.2 Designating Bike Lanes 28

Figure 13-16 Detail of Bike Lane Designation..... 29

13.2.7.3 Contraflow Bike Lanes..... 29

Figure 13-17 Example Contraflow Bicycle Lane Markings..... 30

13.2.7.4 Bike Lanes at Driveways and Intersections..... 30

13.2.7.4.1 Bike Lanes at Continuous Flow Intersections 31

Figure 13-18 Typical Bike Lane - Major Intersection, No Right-Turn Lane - Curb and Gutter 32

Figure 13-19 Typical Bike Lane - Major Intersection, Right-Turn Lane 33

Figure 13-20 Typical Bike Lane - Major Intersection, No Right-Turn Lane, On-Street Parking..... 34

Figure 13-21 Typical Bike Lane - Major Intersection, Right Turn Trap Lane, Bus Stop 35

Figure 13-22 Typical Bike Lane - Tee Intersection, Right Turn Must Turn Right, Bus Stop 36

Figure 13-23 Typical Bike Lane - Tee Intersection, Right-Turn Lane, Bus Bay..... 37

Figure 13-24 Typical Bike Lane - Compact Interchange 38

Figure 13-25 Typical Bike Lane - Rural Interchange..... 39



Figure 13-26 Typical Bike Lane - Continuous Flow Intersection..... 40

 13.2.7.4.2 Two-Stage Turn Queuing Box..... 40

Figure 13-27 Common Maneuvers for Bicyclists Turning Left at an Intersection.. 41

Figure 13-28 Two-Stage Left-Turn Box..... 42

Figure 13-29 Example of Two-Stage Turn Queuing Box at an Intersection..... 43

13.2.7.5 Buffered Bike Lanes..... 43

Figure 13-30 Buffered Bike Lane 44

 13.2.7.5.1 Buffered Bike Lanes at Intersections..... 44

Figure 13-31 Detail of Typical Buffered Bike Lane Designation..... 45

Figure 13-32 Sample Buffered Bike Lane Transition at Intersection with Right-Turn Lane 46

13.2.8 Detection of Bicycles at Signalized Intersections 46

Figure 13-33 Bike Detection Symbol and Bicycle Signal Actuation Sign..... 47

 13.2.8.1 Signal Detection in Bike Lanes 47

 13.2.8.2 Signal Timing for Bicycles..... 47

13.2.9 Bike Lanes at Roundabouts 48

Figure 13-34 Multilane Roundabout 49

13.2.10 Separated Bike Lanes (Cycle Track)..... 50

13.2.11 Bicycle Boulevards 50

13.2.12 Alternative Routes 50

13.2.13 Other Roadway Considerations 51

 13.2.13.1 Roadway Cross Slope 51

 13.2.13.2 Drainage Inlets and Utility Covers 51

Figure 13-35 Bicycle Compatible Drainage Grates 52

Figure 13-36 Bicycle Obstruction Marking in Advance of a Drop Inlet 52

 13.2.13.3 Railroad Crossings..... 52

Figure 13-37 Potential Treatments at a Skewed Railroad Crossing 53

 13.2.13.4 Bridges and Tunnels 53

13.3 Shared-Use Paths 54

 13.3.1 Surface Treatments..... 54

 13.3.1.1 Paved Shared-Use Paths..... 54

 13.3.1.2 Unpaved Shared-Use Paths 54

 13.3.2 Design Speed..... 55

 13.3.3 Sight Distance..... 55

 13.3.3.1 Stopping Sight Distance 55

Table 13-5 Stopping Sight Distance for Bicycles..... 56



13.3.3.2	Sight Distance on Horizontal Curves	57
	<i>Figure 13-38 Stopping Sight Distance on a Shared-Use Path Horizontal Curve</i>	57
	<i>Table 13-6 Minimum Horizontal Clearance for Horizontal Sightline Offset for Horizontal Curves.....</i>	58
13.3.3.3	Sight Distance on Vertical Curves	59
	<i>Figure 13-39 Sight Distance on Crest Vertical Curves=</i>	59
	<i>Table 13-7 Minimum Length of Crest Vertical Curve Based on Stopping Sight Distance</i>	60
13.3.3.4	Sight Distance at Intersections.....	60
13.3.4	Shared-Use Path Width.....	61
	<i>Figure 13-40 Path User Position Signs</i>	62
	<i>Figure 13-41 Selective Exclusion Signs</i>	63
	<i>Figure 13-42 Mode Specific Guide Signs.....</i>	63
13.3.5	Cross Slope	64
13.3.6	Clearances.....	64
	<i>Figure 13-43 Conditions Where Barriers to Embankment are Recommended.....</i>	65
13.3.7	Horizontal Alignment of Shared-Use Paths.....	66
	<i>Table 13-8 Minimum Radii and Superelevation for Bicycle Only Paths</i>	66
13.3.8	Vertical Alignment of Shared-Use Paths.....	67
	<i>Figure 13-44 Bicycle Hill Warning Sign</i>	67
13.3.9	Intersections with Shared-Use Paths.....	68
	<i>Figure 13-45 Functional Area of an Intersection</i>	69
13.3.9.1	Required Sight Triangles at Shared-Use Path Intersections	69
	<i>Figure 13-46 Illustration of Intersection Sight Triangle Dimensions</i>	71
	<i>Table 13-9 Intersection Sight Distance</i>	71
	<i>Table 13-10 Required Sight Distance for Minor Leg of Yield Control</i>	72
	<i>Figure 13-47 Illustration of Intersection Sight Triangle Dimensions Case C3, Yield Condition</i>	73
	<i>Figure 13-48 Illustration of Intersection Sight Triangle Dimensions Path Approaching Sidewalk.....</i>	73
13.3.9.2	Traffic Control at Intersections with Shared-Use Paths.....	74
	<i>Figure 13-49 Intersection Warning (W2 Series) and Advance Warning Signs (W3 Series) Signs.....</i>	74
	<i>Figure 13-50 Trail Crossing Assembly.....</i>	75
13.3.9.3	Reducing Speeds on the Approach to Intersections.....	75
	<i>Figure 13-51 Chicane on Approach to Intersection.....</i>	76
	<i>Figure 13-52 Geometric Design to Slow Bicyclists on Intersection Approaches....</i>	76



13.3.9.4 Curb Ramps 77

13.3.9.5 Prevention of Motor Vehicle Encroachment onto Shared-Use Paths 77

Figure 13-53 No Motor Vehicles Sign (R5-3) 77

Figure 13-54 Example of Schematic Path Entry..... 78

Figure 13-55 Obstruction Striping Around Bollards on Shared-Use Paths 79

13.3.10 Underpass and Overpass Structures 80

13.3.10.1 Width and Clearance for Structures Serving Shared-Use Paths 80

13.3.10.2 Grades on Structures Serving Shared-Use Paths..... 81

Figure 13-56 Maximum Spacing of Resting Intervals on Shared-Use Path Structure Ramps..... 81

13.3.10.3 Railings on Structures Serving Shared-Use Paths..... 81

13.3.10.4 Railroad Crossings 81

Figure 13-57 Example Signage and Markings at a Shared-Use Path Crossing of Railroad..... 82

13.3.10.5 Utilities 83

13.3.10.6 Traffic Calming on Shared-Use Paths 83

13.3.11 Wayfinding on Shared-Use Paths 83

13.3.12 Shared-Use Paths Adjacent to the Roadway (Sidepaths) 83

13.3.13 Safety Considerations of Sidepaths..... 84

13.3.13.1 Potential Mitigation Measures to the Operational Challenges of Sidepaths 85

Figure 13-58 Example Adjacent Path Sign 86

13.3.14 Sidepath Clearance to the Adjacent Roadway 87

13.3.15 Equestrian Facilities 87

13.3.16 Other Considerations on Bicycle Facilities 88

13.3.16.1 Maintenance of Traffic 88

Figure 13-59 Bicycle Facility Detour Signs..... 88

13.3.16.2 Integration of Bicycles with Transit 89

Figure 13-60 Bicycle Channel 89

13.3.16.3 Shared Bicycle Facilities with Bus Transit..... 89

Figure 13-61 Shared Bus Buffered Bike Lane 90

13.3.16.4 Shared Bicycle Facilities with Light Rail..... 90

13.3.16.5 Innovative Signage and Markings..... 90

13.3.16.6 Colored Bike Lanes..... 91

13.3.16.7 Bike Boxes 91

Figure 13-62 Example Striping and Marking for a Bike Box..... 92

13.3.16.8 Bicycle Signals 92



- 13.3.16.9 Maintenance of Bicycle Facilities..... 92
 - 13.3.16.9.1 Snow and Ice Control 93
- 13.4 Pedestrian Facilities..... 93
 - 13.4.1 General Pedestrian Considerations..... 93
 - 13.4.1.1 Accommodating Pedestrians in the Right of Way 93
 - 13.4.1.2 Operating Characteristics of Pedestrians..... 94
 - 13.4.1.3 Americans with Disabilities Act Requirements 95
 - 13.4.1.4 Curb Ramps and Blended Transitions 95
 - 13.4.1.5 Vertical Changes in Grade 96
 - 13.4.2 Sidewalks 96
 - 13.4.2.1 Separation from Roadway..... 96
 - 13.4.2.2 Separation from Roadway with Curb and Gutter..... 96
 - 13.4.2.3 Separation from Roadway without Curb and Gutter..... 97
 - 13.4.2.4 Sidewalk Width 97
 - 13.4.2.5 Protruding Objects..... 97
 - Figure 13-63 Protruding Objects 98*
 - 13.4.3 Grade and Cross Slopes 98
 - 13.4.4 Driveways..... 99
 - 13.4.5 Sidewalk Lighting 99
 - 13.4.6 Transit Stops..... 99
 - 13.4.7 Pedestrian Crossings of Roadways..... 99
 - 13.4.8 Pedestrian Crossings at Intersections 99
 - 13.4.8.1 Pedestrian Crossings at Uncontrolled Approaches to Intersections 100
 - 13.4.8.2 Pedestrian Crossings at Stop and Yield Control Intersections..... 100
 - 13.4.8.3 Pedestrian Crossings at Signal Control Intersections 100
 - 13.4.8.4 Pedestrian Crossings at Roundabouts 101
 - Figure 13-64 Location of Pedestrian Crossings at Roundabouts..... 102*
 - 13.4.9 Pedestrian Crossings at Midblock Locations..... 102
 - Figure 13-65 Detectable Warning Placement in Median Refuge Islands 103*
 - Figure 13-66 Angle Cut through a Median 104*
 - 13.4.9.1 Rapid Rectangular Flashing Beacons 104
 - Figure 13-67 Rapid Rectangular Flashing Beacon..... 105*
 - 13.4.9.2 Pedestrian Hybrid Signals (HAWK Signals)..... 106
 - Figure 13-68 Pedestrian Hybrid Beacon Sequence..... 106*
 - 13.4.9.3 Guidance for Traffic Control Selection at Midblock Crossings 106
 - Table 13-11 Referral Table for Midblock Crossing Treatments 106*



Table 13-12 Traffic Control Devices Tiers 107

Table 13-13 Roadway Volume Less Than 650 Vehicles Per Hour (vph) or 6,700 Vehicles Per Day (vpd) 109

Table 13-14 Roadway Volume Greater than 650 vph (6,700 vpd) and Less Than 1,150 vph (12,000 vpd)..... 109

Table 13-15 Roadway Volume Greater Than 1,150 vph (12,000 vpd) 109

13.4.9.4 Additional Treatments at Midblock Crossings..... 109

Figure 13-69 Approach Slope Markings for Raised Pedestrian Crossings..... 110

13.4.9.5 Signalized Pedestrian Crossings 110

13.4.9.6 Grade-Separated Pedestrian Crossings 110

13.4.9.7 Sidewalk Crossings of Rail Lines 111

Figure 13-70 Example of Flashing -Light Signal Assembly for Pedestrian Crossings 112

13.4.10 Other Pedestrian Considerations 113

 13.4.10.1 Traffic Calming 113

 13.4.10.2 Pedestrian Amenities 113

 13.4.10.3 Pedestrian Wayfinding..... 114

 13.4.10.4 On-Street Parking 114

13.4.11 School Areas 114

Figure 13-71 School Speed Limit Assembly 115

13.4.12 Maintenance of Traffic 115









 13.4.12.1 Pedestrian Considerations in Temporary Traffic Control Zones 115

Figure 13-72 Pedestrian Facility Detour Sign 118

 13.4.12.2 Accessibility Considerations 118



Legend

	Multimodal Application Example
	Context-Sensitive Solutions Application Example
	Performance-Based Practical Design Application Example
	Multimodal (MM)
	Context-Sensitive Solutions (CSS)
	Performance-Based Practical Design (PBPD)
	Web link for additional information
	AASHTO-Specific Information



13 Bicycle and Pedestrian Facilities

13.1 Introduction

Bicycle and pedestrian modes of transportation are key elements of CDOT's mission to provide an integrated multimodal transportation system that effectively and safely moves people, goods, and information. Interconnected bicycle and pedestrian infrastructure accommodate walking and biking as viable transportation modes that contribute to the health, safety, equity, and equality of our communities. To support this mission, CDOT adopted a Policy Directive and a Procedural Directive to improve the accommodation of bicycles and pedestrians in CDOT programs. Additionally, federal surface transportation law places a strong emphasis on creating a seamless transportation system that persons of all ages and abilities can utilize for safe and convenient access to jobs, services, schools, and recreation.

This chapter provides information for planners, designers, and engineers to develop infrastructure that supports walking and bicycling for people of all ages and abilities. This chapter also discusses context-sensitive design and the need to plan and design projects such that they align with local and regional priorities. The selection of the appropriate bicycle and pedestrian facilities is imperative to provide safe, convenient, and accessible transportation options for all users. This guide does not address education, encouragement, evaluation, or enforcement programs that are required to provide a well-rounded system. This Guide does not intend to supersede the need for judgement by knowledgeable transportation or traffic engineering professionals and should serve as engineering guidance.

This chapter consolidates guidance for planners, designers, and engineers to develop the physical infrastructure needed to support people of all ages and abilities walking and bicycling. It also provides additional guidance where none exists in the current standards or guidance documents. This chapter also includes treatments that have FHWA interim approval to represent the state of the practice accurately.

National resources for multimodal design criteria and standards include:

- AASHTO Policy on the Geometric Design of Streets and Highways (2018 AASHTO GDHS) (AASHTO, 2018).
- AASHTO *Guide for the Development of Bicycle Facilities, 4th Edition* (2012).
- AASHTO *Guide for the Planning, Design, and Operation of Pedestrian Facilities, 2nd Edition* (2021).
- FHWA *Small Town and Rural Multimodal Networks* (2016).
- FHWA *Bikeway Selection Guide* (2019).
- FHWA *Achieving Multimodal Networks: Applying Design Flexibility and Reducing Conflicts* (2016b).
- FHWA *Guide for Improving Pedestrian Safety at Uncontrolled Crossings* (2018).
- FHWA *Accessible Shared Streets Notable Practices and Considerations for Accommodating Pedestrians with Vision Disabilities* (2017).
- FHWA *Manual on Uniform Traffic Control Devices for Streets and Highways* (MUTCD) (FHWA, [2009] 2022).
- National Association of City Transportation Officials (NACTO) *Urban Bikeway Design Guide* (2014).
- NACTO *Urban Street Design Guide* (2013).
- NACTO *Transit Street Design Guide* (2016).
- NCHRP *Crossing Solutions at Roundabouts and Channelized Turn Lanes for Pedestrians with Vision Disabilities: A Guidebook* (2017).
- Institute of Transportation Engineers *Implementing Context Sensitive Design on Multimodal Corridors: A Practitioner's Handbook* (2017).
- U.S. Department of Justice 2010 ADA Standards for Accessible Design (2010).
- U.S. Access Board Proposed Guidelines for Pedestrian Facilities in the Public Right-of-Way (PROWAG) (2011).

13.1.1 CDOT Bike and Pedestrian Policy Directive 1602.0

In January 2017, the Colorado Transportation Commission updated CDOT's bicycle and pedestrian Policy Directive 1602.0 (CDOT, 2017). The purpose of this policy is:

The Transportation Commission supports the Colorado Department of Transportation ("CDOT" or "Department") in elevating the needs of bicyclists and pedestrians in the planning, design, and operation of transportation facilities as a

necessary component of all projects. The Department will promote transportation mode choice by enhancing safety and mobility for bicyclists and pedestrians on or along the state highway system. This includes all aspects of accommodating pedestrians and bicyclists, from planning, programming, design, construction, to operation, maintenance and education."

The intent of this policy is to:

It is the policy of the Colorado Transportation Commission to provide transportation infrastructure that accommodates bicycle and pedestrian use of the highways in a manner that is safe and reliable for all highway users. The needs of bicyclists and pedestrians shall be included in the planning, design, and operation of transportation facilities, as a matter of routine. A decision to not accommodate them shall be documented based on the exemption criteria in the procedural directive.

13.1.2 CDOT Bike and Pedestrian Procedural Directive 1602.1

CDOT Procedural Directive 1602.1 requires the incorporation of bicycle and pedestrian considerations throughout CDOT's planning, programming, design, construction and maintenance operations (as well as educational and enforcement efforts) (CDOT, 2017). Specifically with respect to design, the procedural directive states the following:

DESIGN

A wide range of options can serve to enhance bicycle and pedestrian mobility. Bicycle and pedestrian accommodation comes in many sizes and styles from signage and striping to sidewalks and shoulders. Context sensitive solution practices are encouraged to determine the appropriate solution for accommodating bicyclists and pedestrians within the project area so that they are consistent with local and regional transportation plans. Bicycle and pedestrian accommodations shall be integrated into the overall design process for state highway projects that begin the scoping process after the approval date of this procedural directive. Consideration of bicycle and pedestrian accommodations in on-going projects will be incorporated as reasonable and feasible given budget and schedule constraints.

Current AASHTO, MUTCD, and CDOT standards for bicycle and pedestrian facilities shall be used in developing potential facility improvements. To provide consistent information on accommodating bicyclists and pedestrians on the state highway system, staff shall develop a chapter on bicycle and pedestrian design guidelines as part of the existing CDOT Design Manual.

It is recognized that in some limited cases, bicycle or pedestrian facilities may be impractical. Consequently, the procedural directive provides the following:

EXEMPTION

CDOT will utilize FHWA exemption guidance in situations where one or more of the following occur:

- *Bicyclists and pedestrians are prohibited by law from using the roadway.*
- *The cost of establishing bikeways or walkways would be excessively disproportionate to the need or probable use. (Excessively disproportionate is defined as exceeding 20% of the cost of the larger transportation project.)*
- *Where scarcity of population or other factors indicate an absence of need.*
- *In a resurfacing project on a state highway, if the only means of accommodating bicycle and pedestrian needs is adding a shoulder, the project shall be automatically exempted on the grounds that under CDOT's current asset management guidelines, resurfacing money cannot be used for shoulders*
- *If the resurfacing project on a state highway runs through a town, consideration must be given to restriping that portion within the town to accommodate bicyclists and pedestrians. If the accommodation cannot be made, an Exemption must be documented on Form 464BP.*

Requests for an exemption from the inclusion of bikeways and walkways shall be documented with supporting data that indicates the basis for the decision. Exemption requests shall be submitted on the Form 464BP to the Region Transportation Director and the headquarters Bicycle Pedestrian Coordinator. Review and response will be done within 30 days following submittal.

13.1.3 Design Exemptions

The design requirements set forth in this chapter apply to all projects. Pursuant to Chief Engineer Policy Memo 7, “it is imperative that surface treatment dollars are optimized in regard to maintaining the pavement surface. In that light, surface treatment dollars are not to be used to fund enhancements or other project related costs.”



Use this link to access CDOT's Policy Directives:
<https://www.codot.gov/business/designsupport/policy-memos>

When bicycle and pedestrian improvements are included in resurfacing, restoration, and rehabilitation projects, the designer must adhere to the requirements of CDOT Policy Directive 548.0, Safety Considerations on 3R Projects.

When bicycle and pedestrian facilities are required, project managers should investigate additional funding sources to supplement the primary funding for the project. If funds are not



available, the project manager shall document this with a letter to the design file that specifically states what improvements were considered in addition to the efforts made to obtain other sources of funding. Additionally, the project manager should determine if other pedestrian or bicycle improvement projects are planned in the same area to determine if there are opportunities to consolidate the projects. It is not the intent of this chapter to create a new process for documenting design variances and exemptions. A design letter will be used to document when any of the design criteria of this chapter cannot be met on a project. In addition to the Regional Transportation Director approval, when the exemption is for bicycle or pedestrian criteria, the headquarters Bicycle and Pedestrian Coordinator must also acknowledge being provided an opportunity to comment on the request for an exemption.

13.1.4 Federal Guidance Concerning Bicycle and Pedestrian Facilities

13.1.4.1 U.S. Department of Transportation (DOT) Policy Statement

In a policy statement dated March 11, 2010, the U.S. Secretary of Transportation stated the following:

The DOT policy is to incorporate safe and convenient walking and bicycling facilities into transportation projects. Every transportation agency, including DOT, has the responsibility to improve conditions and opportunities for walking and bicycling and to integrate walking and bicycling into their transportation systems. Because of the numerous individual and community benefits that walking and bicycling provide – including health, safety, environmental, transportation, and quality of life – transportation agencies are encouraged to go beyond minimum standards to provide safe and convenient facilities for these modes.

Title 23 U.S.C. 217 states:

Bicycle transportation facilities and pedestrian walkways shall be considered, where appropriate, in conjunction with all new construction and reconstruction of transportation facilities, except where bicycle and pedestrian use are not permitted.

In any case where a highway bridge deck being replaced or rehabilitated with Federal financial participation is located on a highway on which pedestrians or bicyclists are permitted to operate at each end of such bridge, and the Secretary determines that the safe accommodation of pedestrians or bicyclists can be provided at reasonable cost as part of such replacement or rehabilitation, then such bridge shall be so replaced or rehabilitated as to provide such safe accommodations.

13.1.4.2 Restrictions on Severing Bicycle and Pedestrian Facilities

In addition to encouraging the provision of bicycle facilities, FHWA is prohibited from funding projects that would sever or have a significant adverse impact on the safety of non-motorized transportation. Title 23 of the United States Code includes the following (§109(m)):



Protection of Non-Motorized Transportation Traffic. --The Secretary shall not approve any project or take any regulatory action under this title that will result in the severance of an existing major route or have significant adverse impact on the safety for non-motorized transportation traffic and light motorcycles, unless such project or regulatory action provides for a reasonable alternate route or such a route exists.

13.1.5 Context Sensitive Solutions

Context Sensitive Solutions (CSS) is a collaborative, interdisciplinary approach to design. It determines the engineering design features that balance the interests of various stakeholders with the needs of the transportation project to help the project fit harmoniously into its surroundings. CSS is particularly relevant for pedestrian and bicycle facilities because it balances the desired need to move motor vehicles cars with the priorities and safety of vulnerable roadway users and the neighboring communities.

13.1.6 User Counts

CDOT's Bicycle and Pedestrian Program instituted a program to collect bicycle and pedestrian volume data. Bicyclist and pedestrian counts provide data information regarding how many bicyclists and pedestrians use Colorado facilities. New or reconstruction projects, as well as facilities requiring non-motorized evaluation usage, should consider the installation of non-motorized continuous counting stations or conducting short duration counts. This information can be used in setting priorities for new facilities, making engineering decisions, and identifying potential routes. It can also measure increases in bicycling and walking as the Colorado network is improved. Additionally, counts provide a denominator for crash rates.

During the planning or design phase of a project, the project manager should consider installing non-motorized continuous counting stations or conducting short duration counts to determine the level of bicycle and pedestrian usage.



Use this link to access CDOT's bicycle and pedestrian volume data:
<https://www.codot.gov/programs/bikeped/bicycle-pedestrian-counts>

CDOT's Traffic Analysis Unit or the Active Transportation and Main Streets Section within the Division of Transportation Development can provide count data, provide support for selecting a new counting site, or help purchase counting equipment for a project.

13.2 Bicycle Facilities

Bicyclists should be expected on all roadways except where their use is prohibited by law. Per CDOT policies and directives, all design on CDOT facilities, except those roadways where cyclists are prohibited, shall include accommodations for bicyclists. A network of safe, comfortable, connected, and intuitive bicycle facilities supports bicycling as a viable mode of transportation for

people of all ages and abilities. Communities with well-planned and designed networks typically have higher rates of bicycling.



Use this link to view Colorado's Bicycle and Byways Map and the routes where bicycles are prohibited <https://www.codot.gov/business/designsupport/policy-memos>

13.2.1 Bikeway Facility Selection

The selection of a preferred bikeway requires a careful balance of data analysis, engineering judgment, and management of community goals, all while working within existing project constraints. Key selection criteria include the target design user, non-motorized and motorized traffic data, existing and future land use, and other operating characteristics of the roadway.

The type of bicycle facility should be consistent to the maximum degree possible. Alternating facility types on a corridor can cause confusion for both bicyclists and motorists.

Roadway improvements for bicycles should be continued to logical termini. Advanced signage should be provided to inform bicyclists that the facility is coming to an end.

13.2.1.1 Bicyclist User Types

Bicyclists are directly impacted by their perceived comfort operating near or with motor vehicle traffic. Providing low stress, connected bicycle networks improves bicyclist safety and encourages a wider range of bicyclists to use that facility. Many people are interested in bicycling for transportation, but choose not to due to expected, stressful interactions with motorists. It has also been shown that the presence of more bicyclists and pedestrians encourages motorists to look for these street users where they are prevalent.

The FHWA Bikeway Selection Guide (FHWA, 2019), identifies the following three types of bicyclist user types based on a person's age, comfort, skill, experience, and trip purpose (Figure 13-1).

- Interested but Concerned.
- Somewhat Confident.
- Highly Confident.

Figure 13-1 Bicyclist Design User Profiles

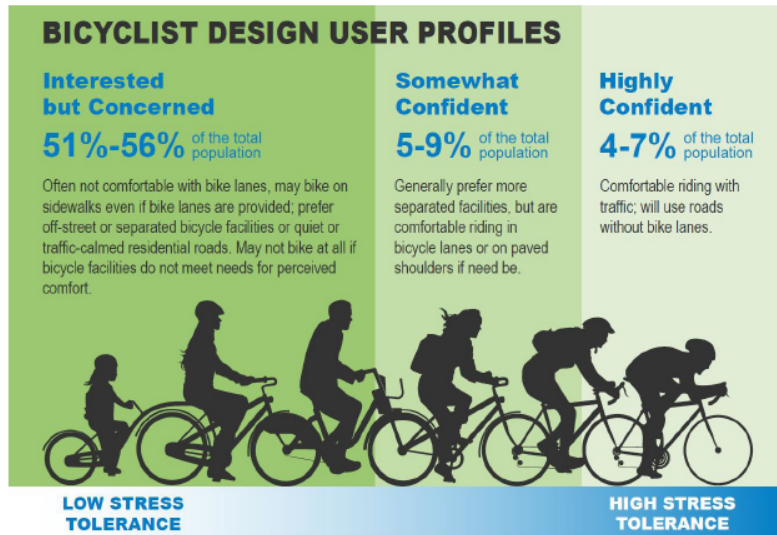

Note: the percentages above reflect only adults who have stated an interest in bicycling.
Source: FHWA Bikeway Selection Guide (FHWA, 2019).

These user types can be used to inform planning and design of bicycle facilities. Generally, the Interested but Concerned bicyclist should be the target design user. This group represents 51% to 56% of the population that would like to bicycle, but choose not to because of the lack of connected, low stress networks. Bicycle facilities designed for this user type maximizes the potential for bicycling as a viable transportation option and accommodates the Somewhat Confident and Highly Confident user types as well.

There are several factors that influence the stress and discomfort for bicyclists: motor vehicle speed, motor vehicle volume, and proximity to traffic. The crash and fatality risks rise significantly when the motor vehicle traffic speed exceeds 25 mph. Additionally, when motorized traffic volumes exceed 6,000 vehicles/day, it becomes increasingly difficult for motorists to share roadway space. For example, on a roadway with 10,000 vehicles/day a bicyclist traveling at 10 mph will be passed approximately every four seconds by a motor vehicle during the peak hour.

Figure 13-2 provides general guidance on how motor vehicle volume and speed should be considered to determine the preferred bikeway type for the Interested but Concerned Bicyclist in Rural Places (C2), Suburban Places (C3), Downtown Places (C5), and Urban Core (C6) Context Classifications (refer to Chapter 1).

Figure 13-2 Preferred Bikeway Type for Interested but Concerned Bicyclists in Rural Places (C2), Suburban Places (C3), Downtown Places (C5), and Urban Core (C6) Context Classifications

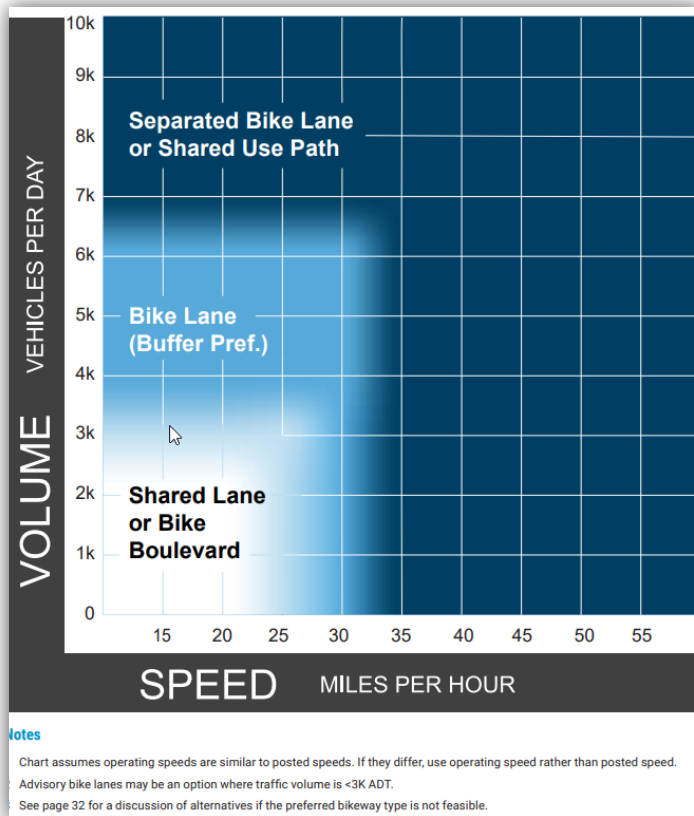

Source: FHWA Bikeway Selection Guide (FHWA, 2019).

Rural roadways, shared lanes, bike lanes, paved shoulders, and shared-use paths are also potential bikeway types. In rural scenarios, Highly Confident or Somewhat Confident bicyclists are most likely to travel long distances on rural roadways between towns and cities and are therefore assumed as the default design user in this context. Figure 13-3 provides general guidance on how motor vehicle volume and speed should be considered to determine the preferred bikeway type for the Highly Confident Bicyclist by providing appropriate shoulder widths.



Figure 13-3 Preferred Shoulder Widths for Rural Roadways

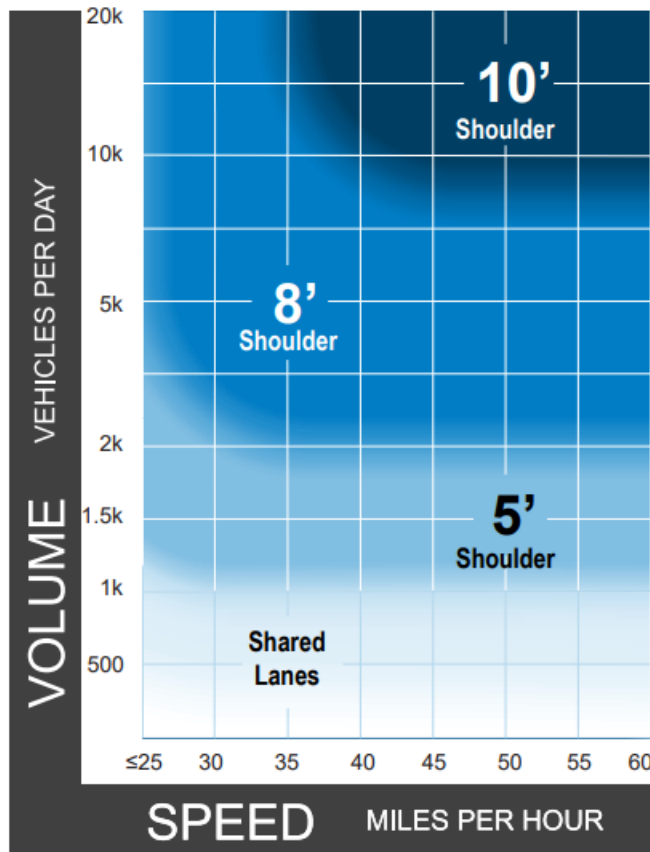

Notes

- 1 This chart assumes the project involves reconstruction or retrofit in constrained conditions. For new construction, follow recommended shoulder widths in the AASHTO Green Book.
- 2 A separated shared use pathway is a suitable alternative to providing paved shoulders.
- 3 Chart assumes operating speeds are similar to posted speeds. If they differ, use operating speed rather than posted speed.
- 4 If the percentage of heavy vehicles is greater than 5%, consider providing a wider shoulder or a separated pathway.

Source: FHWA Bikeway Selection Guide (FHWA, 2019).

13.2.2 On-Road Bicycle Facilities

This section provides design guidance for accommodating bicycles on roadways. Bicyclists have the same rights and duties applicable to a driver of any other vehicle and generally have similar access and mobility needs. Designers of on-road facilities should understand that these facilities are also used by people on scooters, skateboards, and other micro mobility devices, all of which should be considered in the planning and design processes. Travel by these modes should be safely accommodated at bridges, viaducts, tunnels, intersections, traffic signals, interchanges, roundabouts, transit stops, and railroad crossings.

On-road bicycle facilities can take any number of forms and can be any one of the following types:

- Bike routes (Section 13.2.4)

- Shared lanes (Section 13.2.5)
- Paved shoulders (Section 13.2.6).
- Bike lanes/buffered bike lanes (Section 13.2.7).
- Separated bike lanes (cycle tracks) (Section 1313.2.10).
- Bicycle boulevards (Section 1313.2.11).

13.2.2.1 Sharing Roadway Space

Bicycles operating on Colorado roadways are considered vehicles (Colorado Revised Statutes, Section 42-1-102[10]). As such, bicyclists are subject to the same rules of the road as operators of other vehicles. The design criteria and treatment guidance provided in this chapter assume the operation of bicycles as vehicles.

On-road bicycle facilities are the most common facility type on Colorado roadways, since bicycles may operate on all roadways except where prohibited. Most commonly on CDOT projects, the on-road facility is a bike lane or paved shoulder. Other bicycle facilities may be appropriate if the project is located on a non-CDOT roadway or if a project is constrained. If a community or agency has adopted a minimum level of bicycle accommodation (level of service), bike lanes or shoulders that are wider than the minimums may be required to meet that level of accommodation. Where practical, the bicycle facility provided on CDOT roadway projects should comply with the locally adopted bicycle plan.

13.2.3 Additional Bicycle Facility Types

When the preferred on-road bicycle facility cannot be accommodated, alternative or parallel routes (Section 1313.2.12) should be considered to make sure that the project's purpose and need are met. Shared-use paths (Section 13.3) and bicycle boulevards (Section 1313.2.11) are physically separated from motorized vehicular traffic. Bicycle boulevards and may be considered where on-road facilities cannot be accommodated.

13.2.3.1 Role of Design Factors

The level of accommodation for bicyclists can be measured by a range of methods from subjective to objective. The *Highway Capacity Manual* (TRB, 2022) establishes an objective method for determining the level of bicycle accommodation (level of service) based upon the geometric and operational characteristics of the roadway being analyzed. This method is based upon numerous research projects that quantified what factors influence how bicyclists perceive a roadway's safety and comfort. The model for links (roadway segments between intersections) includes the following factors:

- Width of the outside through lane.
- Presence and width of a paved shoulder or bike lane.
- Encroachments into the bike lane.
- Presence and width of a parking lane.
- Percent of parking occupied by parked cars.

- Pavement condition.
- Operating speeds on the roadway.
- Traffic volume on the roadway.
- Percent heavy vehicles on the roadway.

The primary geometric conditions that are influenced by design are the width of the outside lane, the presence of a paved shoulder or bike lane, the width of the paved shoulder or bike lane, and encroachments into the bike lane or paved shoulder. As stated in Section 13.2.2.1, in Colorado, it is likely that paved shoulders and bike lanes are the preferred bicycle facility. However, in some cases, a shared lane may be adequate. Wide outside lanes tend to increase vehicle speeds and should be avoided.

On some projects, pavement cannot be widened or restriped for a paved shoulder or bike lane. On these roads, the project available roadway space and traffic conditions should be analyzed and strive to achieve at least the minimum adopted level of service for bicycles by narrowing motor vehicle lane widths, removing on-street parking, reducing posted speeds, or by using other methods to accommodate bicyclists to provide wide curb lanes.

Designers should consider all likely users of a bicycle facility when establishing design criteria. As with the design of roadways, the design vehicle is an important consideration for bicycle facilities. Most design criteria for roadways, beyond the addition of extra space for the bike lane or paved shoulder, are not impacted by the bicycle as a design vehicle.

On a shared-use path, the bicycle and other non-motorized modes are used as design vehicles. Their characteristics dictate numerous design values and criteria, such as design speeds, stopping sight distances, maximum degree of horizontal curvature, minimum vertical curve lengths, etc. The design values used in this chapter are based upon those in the *AASHTO Guide for the Development of Bicycle Facilities* (AASHTO, 2012), with supplemental information provided from the *FHWA Characteristics of Emerging Road and Trail Users and Their Safety* (FHWA, 2004).

Design vehicle considerations can be grouped as key dimensions, operating space, and key performance criteria. These are briefly summarized in the following paragraphs. Some of those design vehicles expected are shown in Figure 13-4.

- The **key dimensions** that are associated with the various types of bicycles are listed in Table 13-1. These are not exact and represent the 85th percentile (unless otherwise noted) of distribution that encompasses most bicyclists.
- Recommended widths of bicycle facilities can be determined from the bicyclist **operating space**, as shown in Figure 13-5. Additional operating width may be required in circumstances including but not limited to steeper grades, mixed traffic (parked cars), and poorly lit areas.
- Key **performance criteria** that are associated with the various types of bicycles are listed in Table 13-2. These performance criteria vary greatly based on age, health, physical and cognitive abilities, bicycle design, traffic, environmental conditions, and terrain.



Data for e-bikes varies from the data in Table 13-1 and Table 13-2. If e-bikes will potentially be on a trail, the designer should seek guidance on the design standards for this vehicle type.

Table 13-1 Bicycle Dimensions

User Type	Feature	Dimension
Typical upright adult bicyclist	Physical width (95 th percentile)	30 in.
	Physical length	70 in.
	Physical height of handlebars (typical dimension)	44 in.
	Eye height	60 in.
	Center of gravity (approximate)	33-44 in.
	Operating width (minimum)	48 in.
	Operating width (minimum)	60 in.
	Operating height (minimum)	100 in.
	Operating height (minimum)	120 in.
Recumbent bicyclist	Physical Length	82 in.
	Eye height	46 in.
Tandem bicyclist	Physical length (typical dimension)	96 in.
Bicyclist with child trailer	Physical width	30 in.
	Physical length	117 in.
Hand bicyclist	Eye height	34 in.
Inline skater	Sweep width	60 in.



Table 13-2 Key Performance Criteria

Bicyclist Type	Feature	Value	
Typical upright adult bicyclist	Speed, paved level terrain	8 - 15 mph	
	Speed, downhill	20 - 30 plus mph	
	Speed, uphill	5 - 12 mph	
	Perception reaction time		1.5 seconds* (expected stop)
			2.5 seconds* (unexpected stop)
	Acceleration rate	2.5 ft/s ² ¹	
	Coefficient of friction for braking, dry level pavement	0.32*	
	Coefficient of friction for braking, wet level pavement	0.16*	
	Deceleration rate (dry level pavement)	10 ft/s ² ^{1*}	
	Deceleration rate for wet conditions (50- 80% reduction in efficiency)	5 ft/s ² ^{1*}	
Recumbent bicyclist	Speed, level terrain	11 - 18 mph	
	Acceleration rate	3 - 6 ft/s ²	
	Deceleration rate	10 - 13 ft/s ²	

* 2018 AASHTO GDHS.

¹ Parkin, J. & Rotheram, J. (2010) Design speeds and acceleration characteristics of bicycle traffic for use in planning, design and appraisal. Transport Policy, 17 (5). pp. 335-341. ISSN 0967-070X. Available from: <http://eprints.uwe.ac.uk/20767>.

² Figiolizzi, M., Wheeler, N. & Monsere, C. (2013). Methodology for estimating bicyclist acceleration and speed distributions at intersections. Transportation Research Record: Journal of the Transportation Research Board, No. 2387, Transportation Research Board of the National Academies, Washington, D.C., pp. 66-75.

³ Landis, B., Petritsch, T., Huang, H., & Do, A. (2004). Characteristics of Emerging Road and Trail Users and Their Safety. Transportation Research Record: Journal of the Transportation Research Board, (1878), 131-139.



Figure 13-4 Summary of Expected Design Vehicles and Dimensions

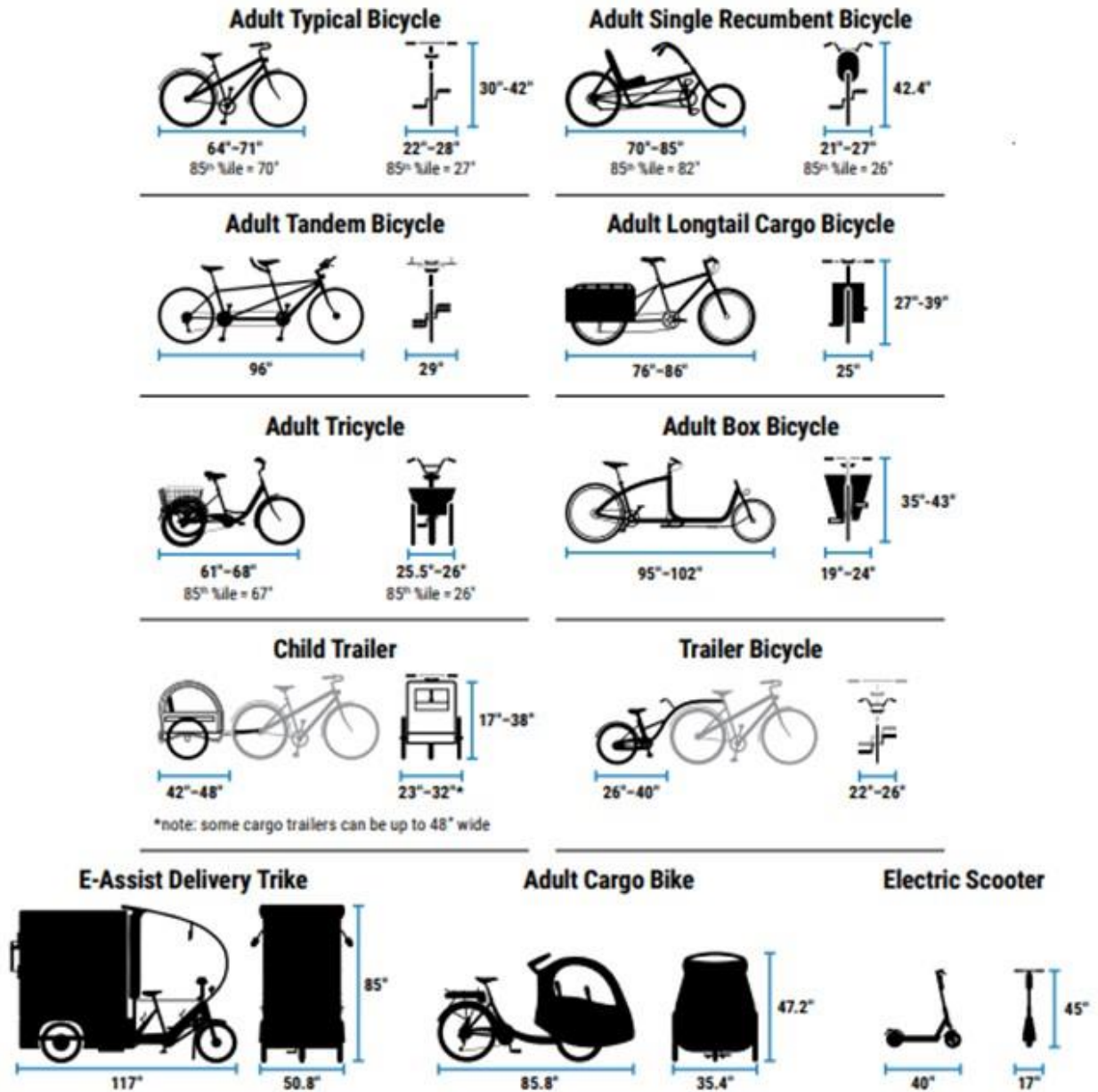
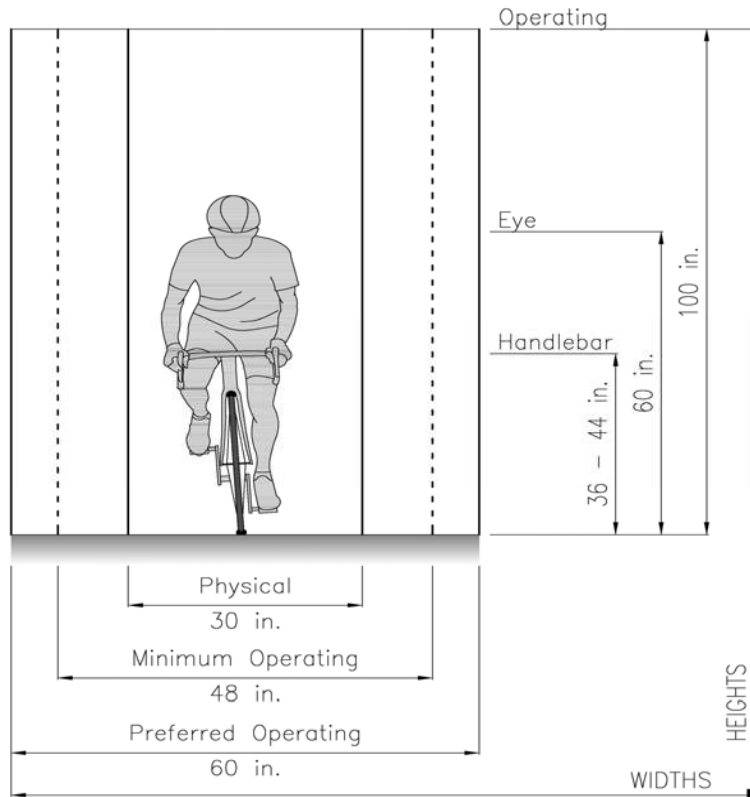

Figure 13-5 Bicycle Operating Space Requirements



With regard to calculated design values such as stopping sight distance or the minimum length of vertical curves, the equations used to calculate the design values are the same for non-motorized vehicles as they are for motorized vehicles. Appropriate assumptions and input values are provided in the section related to specific design values (Section 13.3.3.3).

13.2.4 Bike Routes

Bike routes are not a facility type, but rather a designation of a facility, or collection of facilities, that link origins and destinations that have been improved for, or are considered preferable for, bicycle travel. Bike routes include a system of wayfinding and route signs that provide at least the following basic information:

- Destination of the route.
- Distance to the route's destination.
- Direction of the route.

Bike routes can be designated in two ways: General Routes and Number Routes.

13.2.4.1 General Routes

General Routes are links with a single origin and a single destination. General Routes connect users to destinations within a community. Typical destinations include the following:

- Attraction Areas (e.g., stadiums, parks, etc.)
- Neighborhood Areas (e.g., downtown, historic neighborhoods, etc.)
- Trail Networks or trailheads (e.g., Glenwood Canyon Trail)

Bike Route Guide signs may be provided along designated bike routes to inform bicyclists of bike route direction changes and to confirm route direction, distance, and destination. Typical sign examples that convey the basic wayfinding information for general routes are shown in Figure 13-6. The MUTCD (FHWA, [2009] 2022) provides several different types of signs that can be used to provide guidance along bike routes. Some of these are shown below.

Figure 13-6 Examples of Bike Route Guide Signs



13.2.4.2 Number Routes

Number Routes form a network of bike routes that connect several origins to several destinations. Some communities may implement a numerical system to designate bike routes. These routes should be designated using Bike Route Signs like those in Figure 13-7. Bike Route Signs can be customized by adding a specific community logo in the upper portion of the ellipse.

Figure 13-7 Examples of Bike Route Signs



U.S. Bicycle Route Signs are reserved for routes on the national cycling route network that are designated as U.S. Bicycle Routes. These routes consist of interstate long-distance cycling routes and may consist of different bicycle facility types. As of 2022, Colorado does not have any

designated U.S. Bike Routes. AASHTO approved the use of a marker design for these routes that is included in the MUTCD. It is illustrated in Figure 13-8.

Figure 13-8 U.S. Bike Route Sign



M1-8a

13.2.5 Shared Lanes

A shared lane is a lane of a traveled way used for both bicycle and motor vehicle modes that may be either marked or unmarked. Shared lanes are typically marked where there is a desire to increase awareness of bicyclists on a roadway where physical separation is desired, but not necessarily feasible. Shared lanes are not recommended on facilities where posted speeds are 35 mph or higher (FHWA, [2009] 2022).

Where shared lanes are proposed, travel lane widths should generally be the minimum widths appropriate for the context of the roadway. Generally shared lanes are less than 14 feet wide. In the past, it was common practice to provide wide curb lanes or lanes that exceed 14 feet in width with the expectation that motorists could pass a bicyclist without encroaching into the adjacent lane. However, research finds that this configuration does not allow for adequate passing space and motorists generally do not recognize that the additional space is dedicated for bicycle use. Additionally, wider travel lanes are associated with increases in motor vehicle speeds, which reduce comfort and safety for bicyclists and other roadway users. Therefore, wide curb lanes are not recommended for bicycle accommodation. Where wide curb lanes exist, roadways should be striped to reduce the wide lanes to minimum lane widths. Additional space may be repurposed for other use such as bike lanes, wider sidewalks, etc.

Providing a constrained-width or minimum-width bike lane is preferred to a wide outside lane. However, constrained-width or minimum-width bike lanes should only be used in constrained locations after all travel lanes have been narrowed to minimum widths appropriate for the roadway context. For bicycle lanes adjacent to on-street parking, designers should follow guidance in Section 13.2.6.1.

The *Highway Capacity Manual* method can be used to determine the minimum level of accommodation for bicycles along a bike facility. On local roadways with low volumes and speeds, a shared lane may be all that is needed to comfortably accommodate bicyclists. They are also an option on roadways where it may be infeasible to provide bike lanes or paved shoulders, or to adjust lane widths to provide a wide curb lane.

In these latter cases, there are multiple options for traffic control devices that are described in the following subsections, particularly if the roadways are identified as priority routes in an adopted bicycle plan.

13.2.5.1 Shared Lane Signage

On constrained roadways with posted speed limits of 35 mph and below, the roadway lane may be signed as a shared lane using signage and shared lane bicycle markings. Signage options include:

The MAY USE FULL LANE sign (R4-11) (Figure 13-9) may be used on roadways where a travel lane is too narrow for motorists to overtake a bicyclist without changing lanes (FHWA, [2009] 2022). Rather than provide wider lanes to allow passing, which causes safety issues, this sign may inform users that bicyclists have the legal right to claim the lane. Additional guidance on the MAY USE FULL LANE sign is provided in the MUTCD.

Figure 13-9 May Use Full Lane Sign



R4-11

A SHARED LANE MARKING (refer to Section 13.2.5.2.2) may be used in conjunction with the MAY USE FULL LANE sign.

STATE LAW MOTORIST MUST GIVE BICYCLES 3 FT CLEARANCE

Per CRS 42-4-1003, the driver of a motor vehicle overtaking a bicyclist proceeding in the same direction shall allow the bicyclist at least a 3-foot separation between the right side of the driver's vehicle, including all mirrors or other projections, and the left side of the bicyclist at all times. As an alternative to SHARE THE ROAD signage (refer to Section 13.2.5) The STATE LAW MOTORIST MUST GIVE BICYCLES 3 FT CLEARANCE sign (Figure 13-10) may be used to remind motorists that they must maintain a safe distance while passing a bicyclist.

Figure 13-10 Bicycle 3-Foot Clearance Sign

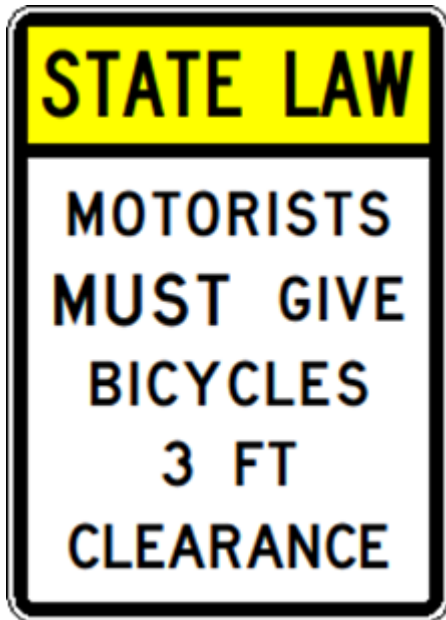

SHARE THE ROAD Sign Assembly (W11-1 + W16-1P)

In situations where there is a need to warn drivers to watch for bicycles traveling along the highway, the SHARE THE ROAD sign assembly may be considered (refer to Figure 13-11).

The SHARE THE ROAD sign assembly may be installed on CDOT-maintained roadways at the discretion of each region's Traffic Engineer. To have maximum effect, these signs should be used with discretion. Consideration for placement should be given where:

- A relatively high number of cyclists can be expected on the roadway.
- The roadway cannot be improved for bicyclists.
- The road narrows for a short distance and a motorist and bicyclist may unexpectedly find themselves using the same roadway such as at the end of a bike lane or bridge approach.
- There has been a history of high numbers of bicycle crashes.

The Share the Road sign assembly may also be appropriate in the following situations:

- Designated bike routes and trails that are placed on short stretches of a major roadway that has not been improved for bicycling.
- Roadway where a known conflict problem exists.
- Roadway sections adjacent to shared-use paths where some bicyclists choose to ride on the roadway.

Figure 13-11 Share the Road Sign Assembly



On approaches to bridges, tunnels, or any other section where motorists and bicyclists have reduced sight distance or where operating widths must be less than desirable due to right of way or actual roadway geometry restrictions, a SHARE THE ROAD sign assembly may be appropriate. In these cases, consider adding flashing beacons to the assembly that can be actively or passively triggered by bicyclists. The duration of the flashing beacon's activation should be such that a motorist passing the active flashing beacon is likely to pass the bicyclist who activated the treatment within the area of limited sight distance. This duration can be calculated using the following equation:

$$t_f = 1.47 \left(\frac{l_c}{S_b} - \frac{l_c}{S_m} \right)$$

Where:

t_f = duration of flashing (sec)
 l_c = length of constrained area (ft)
 S_b = speed of bicyclist (mph)
 S_m = speed of motorists (mph)

The recommended assumed speed of the bicyclist on flat terrain for this application is 10 mph. This is the observed average speed of bicyclists (FHWA, 2004). Adjustments for grade should be made, particularly on uphill sections, where bicyclists are traveling slower than average speeds.

A SHARED LANE MARKING (refer to Section 13.2.5.2) may be used in conjunction with the SHARE THE ROAD sign assembly.

13.2.5.2 Shared Lane Markings

SHARED LANE MARKINGS (Figure 13-12) are intended to perform any of several functions listed in the MUTCD:

- Assist bicyclists with lateral positioning in a shared lane with on-street parallel parking to reduce the chance of a bicyclist impacting the open door of a parked vehicle.
- Assist bicyclists with lateral positioning in lanes that are too narrow for a motor vehicle and a bicycle to travel side by side within the same traffic lane.
- Alert road users of the lateral location bicyclists are likely to occupy within the traveled way.
- Encourage safe passing of bicyclists by motorists.
- Reduce the incidence of wrong-way bicycling.

Figure 13-12 Shared Lane Marking

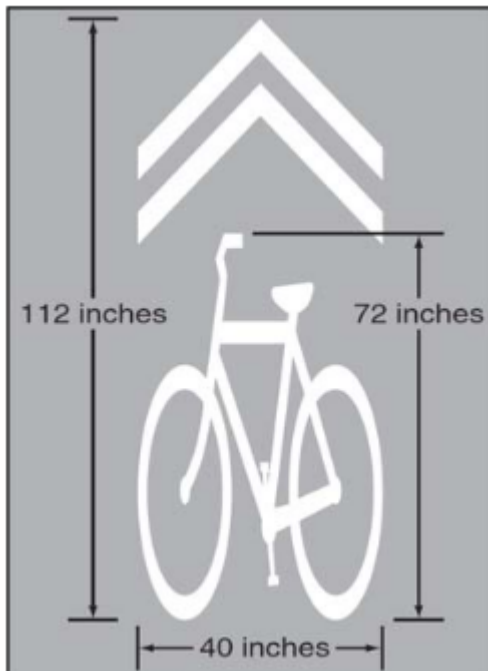

Refer to the MUTCD for proper placement of SHARED LANE MARKINGS.

SHARED LANE MARKINGS should not be used on constrained facilities, on designated bike routes, or on higher-speed roadways (> 35 mph) with designated bike lanes. Traffic calming or signal improvements should be considered in conjunction with SHARED LANE SIGNING.

13.2.6 Paved Shoulders

Paved shoulders are the portion of the roadway that accommodates stopped or parked vehicles, emergency vehicles, farm equipment or other slow-moving vehicles. Shoulders also accommodate

bicyclists and pedestrians where sidewalks do not exist. Paved shoulders have been shown to provide safety benefits for all users and double as an important option for providing comfort and safety for bicyclists on roadways that meet any of the following conditions:

- Traffic volumes that exceed 3,000 vehicles/day.
- Motor vehicle speeds greater than or equal to 50 mph.
- Inadequate sight distances for the typical operating speed or grades in excess of 5%.
- High percentages (> 10%) of heavy vehicles.

Gravel shoulders are not acceptable as bicycle facilities. Adding or widening of paved shoulders may be subject to Municipal Separate Storm Sewer System (MS4) permitting requirements, which could substantially increase retrofit costs.

To accommodate bicyclists, paved shoulders with rumble strips at least 4 feet wide should be provided. Chapter 7 provides CDOT's minimum standard shoulder widths.

13.2.6.1 Additional Width

When local shoulder widths exceed the planned or typical CDOT shoulder, the designer should consider designing to the local requirements.

Jurisdictions may have adopted a minimum bicycle level of service for their roadways. CDOT projects within these jurisdictions should be designed to meet the adopted minimum bicycle level of service unless the available budget prohibits this action. Table 13-3 uses the aforementioned *Highway Capacity Manual* method to provide the maximum design daily traffic, a given speed limit, percent heavy vehicles, and shoulder width, Table 13-3 provides the maximum number roadway AADT that will provide a selected bicycle Level of Service. Additionally, Figure 13-13 shows preferable shoulder widths based on volume and speed of the roadway for the Highly Confident Bicyclist on rural roads.

Scenic Byways plans may also specify wider shoulders and should be accommodated during design.



Table 13-3 Maximum Motor Vehicle Service Volumes for Given Bicycle LOS Grades

Adopted Bicycle Level of Service = B

Shoulder width, ft		Speed Limit (or Design Speed) 35						Speed Limit (or Design Speed) 45					
		Percent Heavy Vehicles						Percent Heavy Vehicles					
		2	4	6	8	10	12	2	4	6	8	10	12
4	4	13300	7500	4500	3600	3100	2700	11200	6200	3900	3400	3000	2500
	6		26400	10100	4800	3700	3200		16400	6600	4200	3500	3000
	8				27000	8100	3700				12200	3900	3400

Shoulder width, ft		Speed Limit (or Design Speed) 55						Speed Limit (or Design Speed) 65					
		Percent Heavy Vehicles						Percent Heavy Vehicles					
		2	4	6	8	10	12	2	4	6	8	10	12
4	4	9900	5600	3800	3300	2800	2400	8900	5200	3700	3200	2700	2300
	6		12200	6100	3900	3400	2800	29900	10300	5600	3800	3300	2800
	8			29900	7600	3800	3300			22400	5200	3800	3200

Adopted Bicycle Level of Service = C

Shoulder width, ft		Speed Limit (or Design Speed) 35						Speed Limit (or Design Speed) 45					
		Percent Heavy Vehicles						Percent Heavy Vehicles					
		2	4	6	8	10	12	2	4	6	8	10	12
4	4			12700	5100	3700	3100		21200	7100	4400	3500	2900
	6				24900	7300	3700				11600	3900	3400
	8											22400	4700

Shoulder width, ft		Speed Limit (or Design Speed) 55						Speed Limit (or Design Speed) 65					
		Percent Heavy Vehicles						Percent Heavy Vehicles					
		2	4	6	8	10	12	2	4	6	8	10	12
4	4		15800	6500	4100	3400	2800		12700	6100	3900	3200	2700
	6			27600	7100	3800	3200				5200	3700	3100
	8					12000	3800					7600	3600

Adopted Bicycle Level of Service = D

Shoulder width, ft		Speed Limit (or Design Speed) 35						Speed Limit (or Design Speed) 45					
		Percent Heavy Vehicles						Percent Heavy Vehicles					
		2	4	6	8	10	12	2	4	6	8	10	12
4	4					9300	3700				14700	4100	2900
	6						13900					20700	4400
	8						15100						

Shoulder width, ft		Speed Limit (or Design Speed) 55						Speed Limit (or Design Speed) 65					
		Percent Heavy Vehicles						Percent Heavy Vehicles					
		2	4	6	8	10	12	2	4	6	8	10	12
4	4				9000	3900	3200			26200	6200	3800	3100
	6					11300	3700					7100	3500
	8						16600						9500

Notes:

Volumes are based upon a two-lane roadway. For maximum service volumes on a four-lane or six-lane roadway double or triple the values accordingly.

Values are established using the Highway Capacity Manual methodology for roadway links.

Table assumes the following: K = 0.10; D = 0.53; PHF = 1; PavCon = 4; Outside lane width = 12 feet

Figure 13-13 Shoulder Widths to Accommodate Highly Confident Bicyclists on Rural Roadways

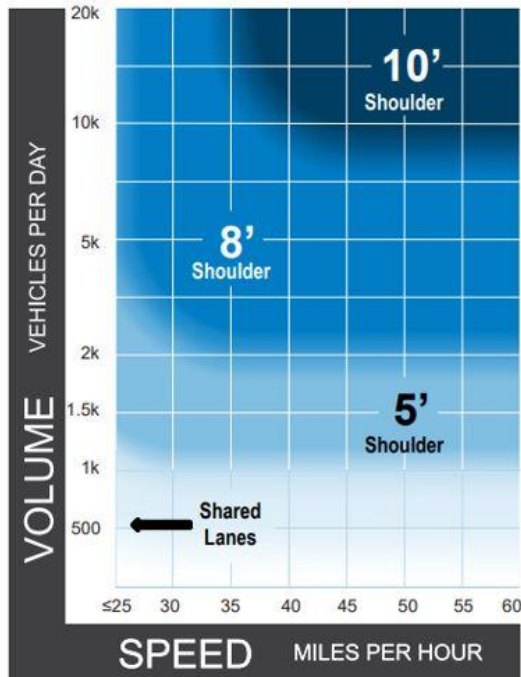

Notes

- 1 This chart assumes the project involves reconstruction or retrofit in constrained conditions. For new construction, follow recommended shoulder widths in the ODOT L&D Manual Volume 1.
- 2 A separated shared use pathway is a suitable alternative to providing paved shoulders.
- 3 Chart assumes operating speeds are similar to posted speeds. If they differ, use operating speed rather than posted speed.
- 4 If the percentage of heavy vehicles is greater than 10%, consider providing a wider shoulder or a separated pathway.

Source: FHWA Bikeway Selection Guide (FHWA, 2019).

13.2.6.2 Shoulder Pavement Quality

Shoulder surface conditions and pavement smoothness are important factors for bicyclist comfort, control, and safety. Surface defects can contribute to bicycle crashes. In addition to the quality of the shoulder pavement, the shoulder should be maintained to remove debris such as gravel or glass. Surfaces adjacent to shoulders should also be addressed to avoid drop offs where erosion may have washed away adjacent unpaved surfaces.

13.2.6.3 Shoulders on Steep Grades

The additional effort required of bicyclists riding uphill frequently results in a greater side-to-side sweep width than those riding on a flat roadway. A bicyclist riding downhill on a steep grade also may need additional space to maintain a comfortable distance from the edge of the pavement and adjacent vehicles. Consequently, on roadways with significant grades or long grades, shoulders of 6 feet or greater width should be provided.

13.2.6.4 Rumble Strips

Where appropriate, rumble strips should be installed per CDOT Standard Plan No. M-614-1. On roadways where bicycle demand exists, continuous rumble strips should not be used. Rumble strips shall not be installed on shoulders less than 6 feet wide when guardrail is placed at the edge of the shoulder. Gaps in rumble strips should also be provided at locations where driveways, intersections, or other locations exist where bicycles are likely to leave the shoulder.

Rumble strips should be placed as closely as possible to the right edge of the roadway edge line. A minimum 4-foot clear shoulder should be provided to the right of the rumble strips. A warning marking as shown in Figure 13-14 should be placed in advance of each rumble strip installation.

Figure 13-14 Advance Warning Stripe for Rumble Strips

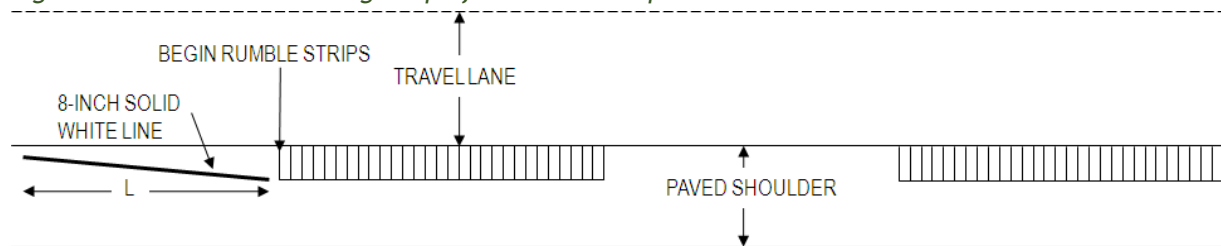

$$L = 20 * W$$

Where W = width of rumble strip

13.2.6.5 Shoulders at Intersections

At intersections with right-turn lanes, a paved shoulder is typically continued along the outside of the right-turn lane. Some through bicyclists may continue to ride along the shoulder even though it compromises their safety at the intersection. Consequently, a 4-foot minimum space (bike slot) should be striped between the right-turn lane and the through lanes. This is illustrated in Figure 13-15.

Figure 13-15 Bike Slot at Intersection

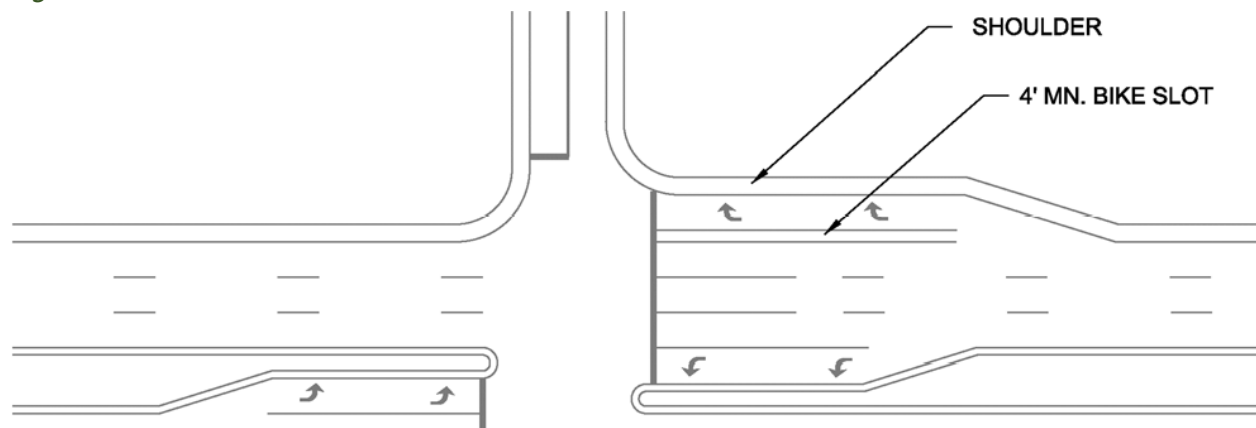

13.2.7 Bike Lanes

Bike lanes are one-way bikeways designated for the preferential use of bicyclists. Bike lanes will typically carry bicycle traffic in the same direction as adjacent motor vehicle traffic. In most cases, bike lanes should be provided on both sides of two-way streets. They may be placed on the left side of one-way streets if the predominant travel paths or conflict points suggest this is a desirable option.

13.2.7.1 Bike Lane Width

Table 13-4 prescribes typical widths for bike lanes that will generally accommodate a bicyclist’s operating space, passing distance, and shy distances to vertical elements.

Table 13-4 One-Way Standard Bike Lane Width Criteria

Bike Lane Description	Minimum Width (ft)	Constrained Width (ft)
Adjacent to curb ¹ or edge of pavement	5	4
Between travel lanes or buffers	5	4
Adjacent to parking ²	6	5
Intermediate or sidewalk level raised bike lane ¹	5.5	5
To allow side-by-side bicycling or passing	8	7

¹ Exclusive of the gutter unless the gutter is integrated into the full width of the bike lane.

² Raised bike lanes adjacent to parking should have a minimum width of 7 feet.

The width of a bicycle lane does not include the width of gutter adjacent to a curb. Where a bicycle lane is adjacent to the gutter, the width of a bike lane should be measured from the edge of the gutter to the center of the bike lane line. Where a bicycle lane is located next to a curb without a gutter, the bike lane width should be measured from the face of curb to the center of the bike lane line. On streets with on-street parking, the bike lane width should be measured from the center of the parking stripe to the center of the bike lane line.

Additional bicycle lane width should be considered in the following conditions:

- Locations with high parking turnover
- Where side-by-side bicycle travel is desired
- Where roadways have sharp drop offs or irregular edges
- Where bicycle lanes are positioned between two moving travel lanes such as a turn lane and a through lane at an intersection
- On roadways that have more than 5% heavy vehicles, posted speeds of 30 mph or over 6,000 AADT

On extremely constrained low-speed roadways with curbs, but no gutter and where the preferred bike lane width cannot be achieved after narrowing all other travel lanes, turn lanes, on-street parking widths, and median widths, a 4-foot-wide bike lane can be used.

Where wider bike lanes are feasible, a buffer should be considered to reduce instances of a motorist attempting to use the bike lane as a travel lane or parking lane.

As mentioned in Section 13.2.6.1, adopted bicycle plans and Scenic Byway plans should be consulted to determine if wider bike lanes are specified or if a wider bike lane is needed to meet an adopted bicycle level of service standard.

On roadways with narrow parking lanes, wider bike lanes (6 or 7 feet wide) should be considered to provide space for bicyclists to avoid opening car doors. On roadways with on-street parking where there is high frequency of parking turnover, a 13 feet minimum width is recommended between the face of curb and the left side of the bike lane.

On roadways where significant volumes of bicyclists are expected, creating a potential need for passing maneuvers, 6- or 8-foot bike lanes should be considered.

Wide shoulders or bike lanes have the potential to be interpreted by motorists as additional general-purpose travel lanes or parking lanes. This can be discouraged by using designated or buffered bike lanes (Section 13.2.7.5).

Additional width should be considered on roadways with steep or long grades. An alternative option to a wider lane is to remove the bike lane on the downhill side of the road and mark with Bicycle May Use Full Lane signs (R4-11) and Shared Lane Markings. The space gained from removing the bike lane on the downhill side of the road should be used to increase the bike lane width on the uphill side of the road.

13.2.7.2 Designating Bike Lanes

Bike lanes shall be designated with the bicycle symbol with the directional arrow being optional (Figure 13-16). Although use of the directional arrow is optional, it is strongly recommended to better communicate the requirement for bicyclists to ride with traffic as the law requires.

Figure 13-16 Detail of Bike Lane Designation

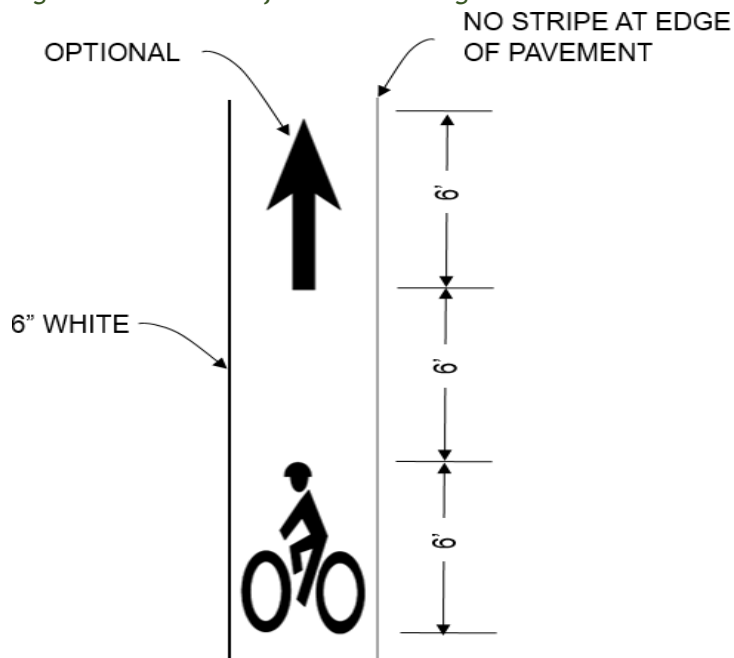

Bicycle lane markings should be placed after intersections and major driveways. In rural areas, the maximum spacing of bike lane markings should not exceed 1,320 feet. In urban areas, the spacing should not exceed 600 feet.

The 6-inch white stripe on the left of the bike lane should become a dotted (2-foot line with a 4-foot gap) at improved bus stops with alighting pads to clarify that buses are to move right to allow transit riders to disembark off of the roadway.

13.2.7.3 Contraflow Bike Lanes

A contraflow bicycle lane is an area of the roadway designated to allow bicyclists to travel in the opposite direction of traffic on a roadway that restricts motor vehicle travel to one direction. These may be used to make convenient connections for bicyclists along otherwise one-way streets. If used, a contraflow bicycle lane should be marked so that bicyclists in the contraflow lane travel on the bicyclists' right-hand side of the road.

Where used, a contraflow bicycle lane shall be separated from opposite-direction travel by use of a solid double yellow center line marking, or a painted or raised median island (Figure 13-17).

The required widths of a contraflow bike lane match Figure 13-17. However, if a median is used, appropriate shy distances from curb and gutter must be considered.

Figure 13-17 Example Contraflow Bicycle Lane Markings

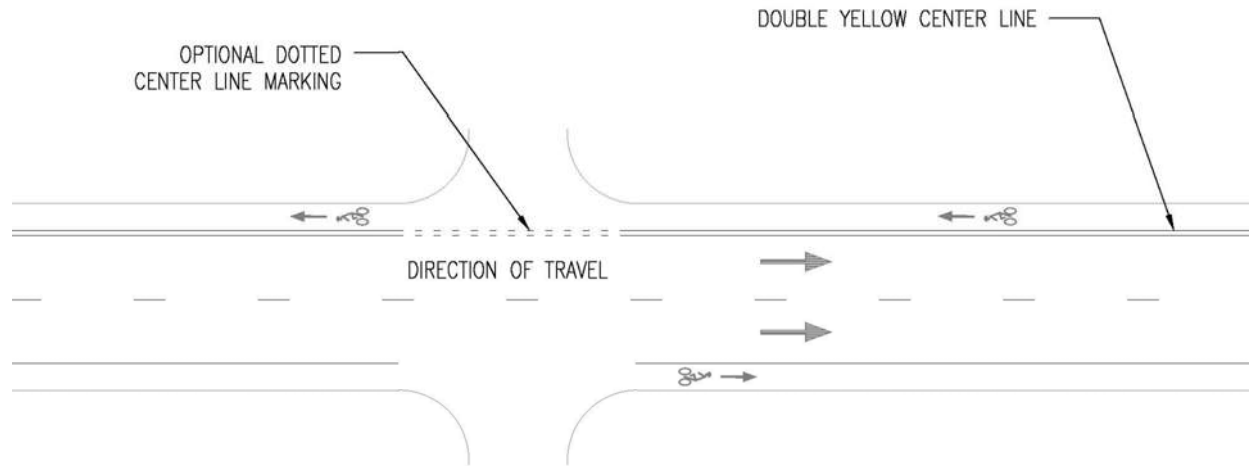

ONE WAY (R6-1 or R6-2) signs should not be used where signs that regulate turns from streets or driveways that intersect with a roadway with a contraflow bicycle lane. TURN PROHIBITION signs (R3-1 or R3-2) with a supplemental message EXCEPT BICYCLES (or the word “EXCEPT” over the bicycle symbol) plaques should be used. If DO NOT ENTER signs (R5-1) are used, an EXCEPT BICYCLES plaque should be placed under the Do Not Enter sign.

A bicycle lane for travel in the same direction as the general purpose lanes may be relocated from the right side of the roadway to the left side of the general purpose travel lanes.

13.2.7.4 Bike Lanes at Driveways and Intersections

In Colorado, bicycles are vehicles when riding on the street (C.R.S., Section 42-4-1412). Therefore, bike lane striping and marking at intersections should be designed to guide bicycle operations the same as vehicles, and to safely manage the conflict points with vehicles at driveways and intersections.

Bicyclists are required to ride on the right-hand side of the rightmost lane in the direction they are traveling. Bicyclists may use left- and right-turn lanes to make turns. Bicyclists are not required to ride at the right edge of the pavement; they may move left to pass slower vehicles, to make a left turn, or to avoid debris or obstacles on the pavement (C.R.S., Section 42-1-102).

For both motor vehicles and bicycles, the approach to a right turn and the right turn should be made from as close as practicable to the right-hand curb or edge of the roadway (C.R.S., Section 42-4-901(1)). Motorists must yield to bicyclists in the bike lane to make a right turn (C.R.S., Section 42-4-1007(1)(a)). The white solid bike lane striping either terminates or becomes dotted on the approach to the right turn at the intersection. Changing the line pattern from a solid line to a dotted line indicates that the motorist can cross the line to make a right turn (MUTCD) and indicates that the bicyclist is entering a potential conflict area. The length of the dotted line can vary based on the speed of the roadway at the approach. A minimum 60-foot dotted line (or gap in the bike lane) should be provided; this is based upon a 1:12 taper rate and a 5-foot bike lane. An

18:1 taper rate or 24:1 taper rate (75-ft and 100-ft) or longer dotted length of bike lane can be used on higher speed roadways.

Where motorists cross a bike lane to move into a right-turn lane, is the BEGIN RIGHT TURN LANE YIELD TO BIKES sign (R4-4) (Figure 13-19, Figure 13-23, Figure 13-24, and Figure 13-26). However, in the trap lane condition (Figure 13-21), the through bicyclist must cross the motorist's path to continue through the intersection. In this case, the bicyclist must yield to the motorist before moving left; therefore, the R4-4 is not appropriate in these conditions.

On retrofit projects, it may not be possible to include bike lanes that pass through existing intersections with turn lanes. In this case, the bike lane should be terminated in advance of the intersection and SHARED LANE MARKINGS should be considered for the left side of the right-turn lane. An example of this marking is shown in Figure 13-31 in Section 13.2.7.5.

In locations with significant numbers of right-turning bicyclists, an additional bike lane for right turning bicyclists can be provided. Right-turn bike lanes may be considered with high-volume, high-speed right-turn lanes. These bike lanes should include right-turn arrows and the text message ONLY.

By riding in the roadway in a predictable and consistent manner, bicyclists are more visible. This increased visibility has been shown to reduce crashes compared to riding on a sidewalk or pathway next to the roadway (FHWA, 1997) (FHWA, 1996) (ITE, 1994) (TRB, 1998) (TRB, 2006).

13.2.7.4.1 Bike Lanes at Continuous Flow Intersections

At continuous flow intersections, a bike lane is provided for through bicyclists. Two options are available for left-turning bicyclists:

- Left-turning bicyclists may ride through the intersection or in the left-turn lanes. Additional bike lanes for left-turning bicyclists may be considered.
- Left-turning bicyclists may make two consecutive through movements obeying all traffic control devices (C.R.S., Section 42-4-1412(8)). A staging area for the bicyclists to wait between through movements should be provided.

Dedicated right-turn lanes for bicyclists should also be considered at continuous flow intersections.



Figure 13-18 Typical Bike Lane - Major Intersection, No Right-Turn Lane - Curb and Gutter

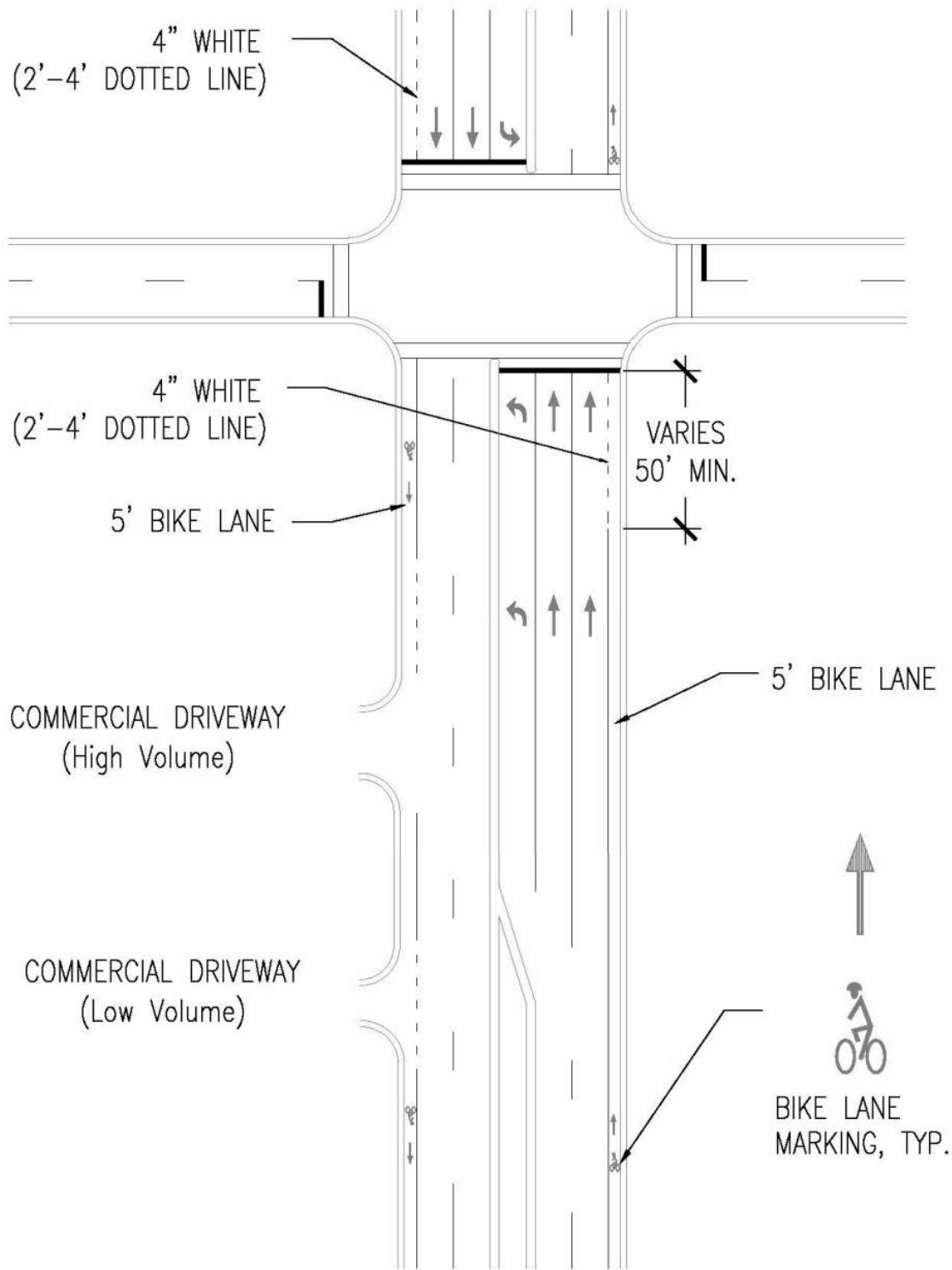



Figure 13-19 Typical Bike Lane - Major Intersection, Right-Turn Lane

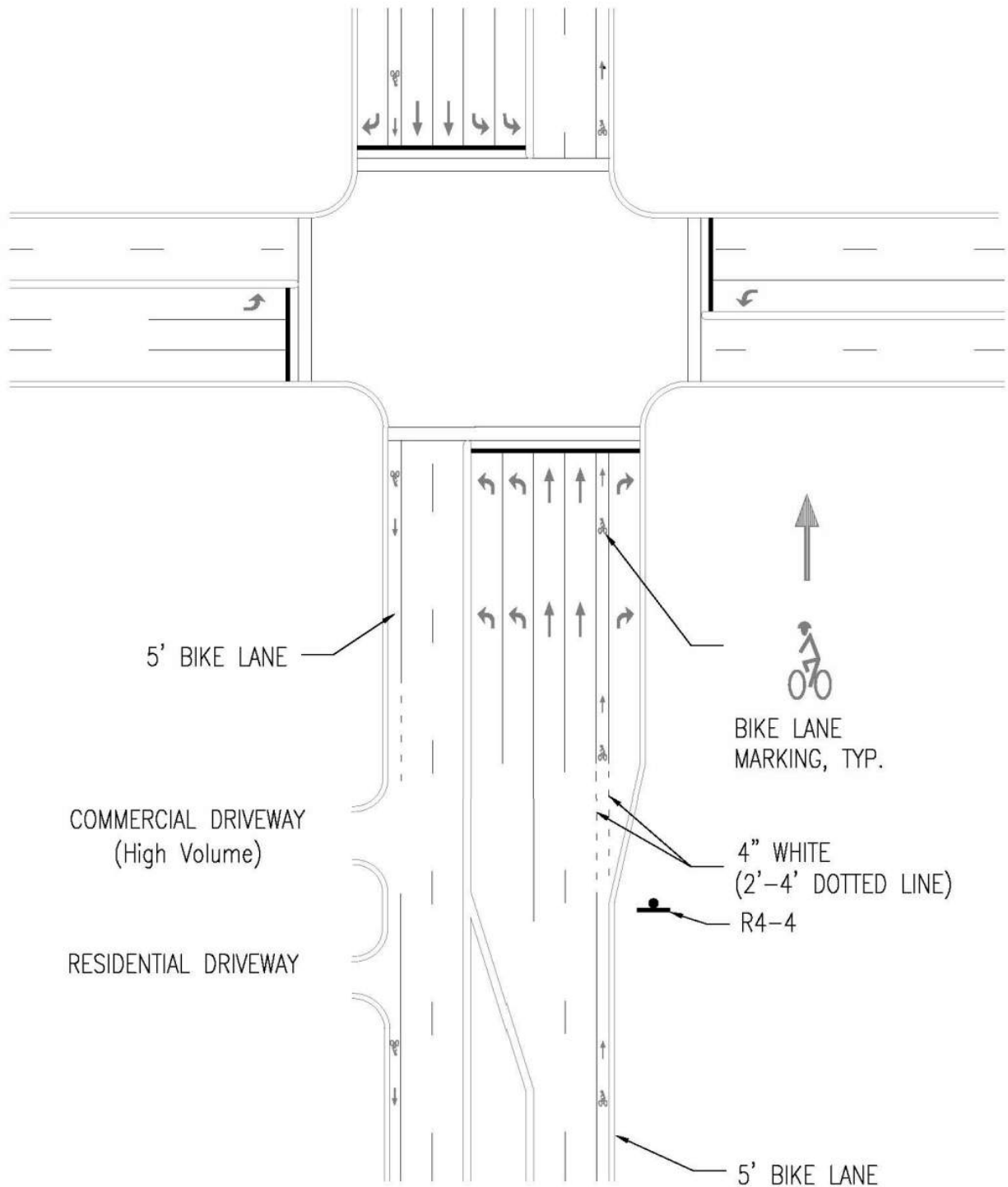



Figure 13-20 Typical Bike Lane - Major Intersection, No Right-Turn Lane, On-Street Parking

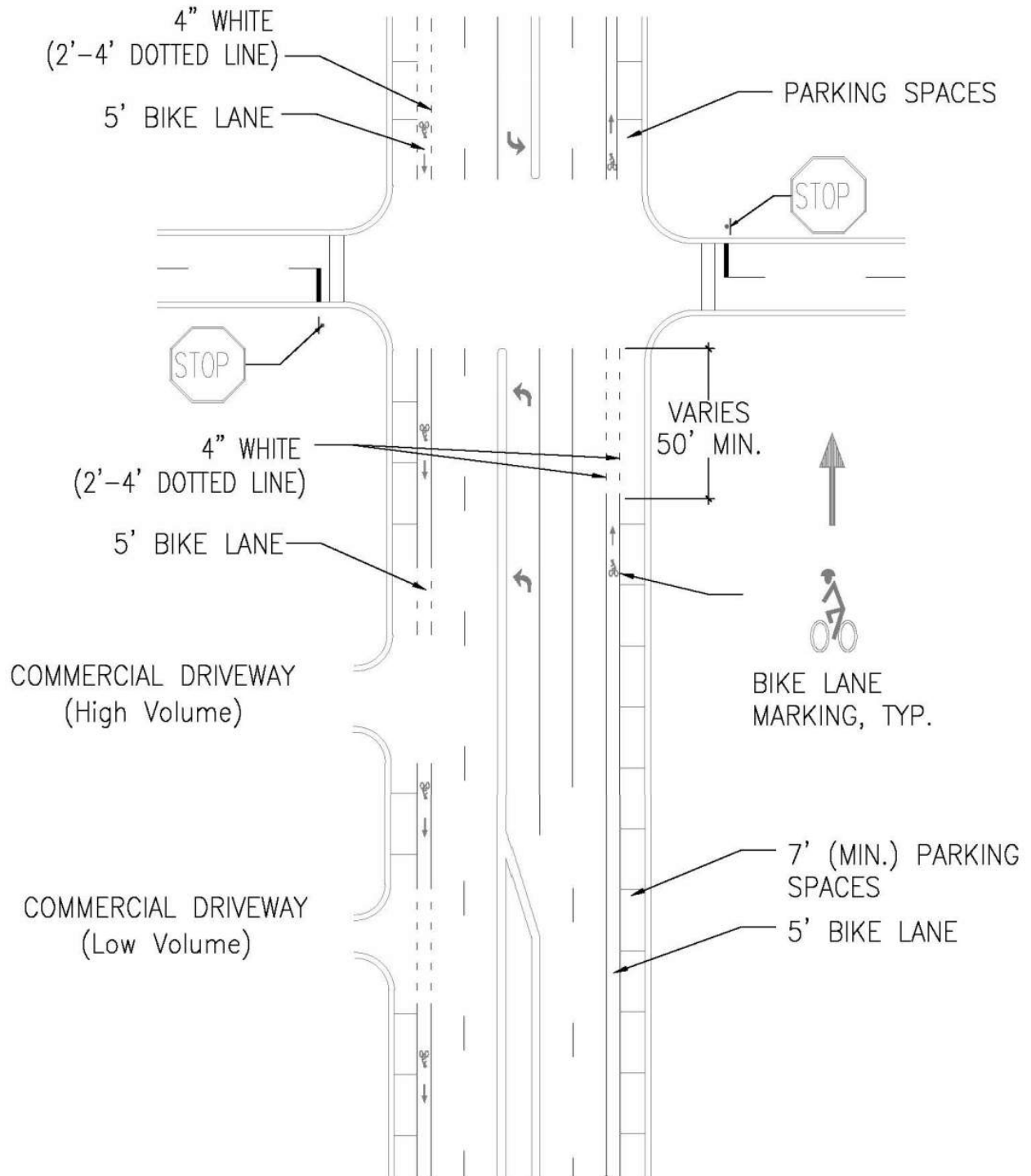



Figure 13-21 Typical Bike Lane - Major Intersection, Right Turn Trap Lane, Bus Stop

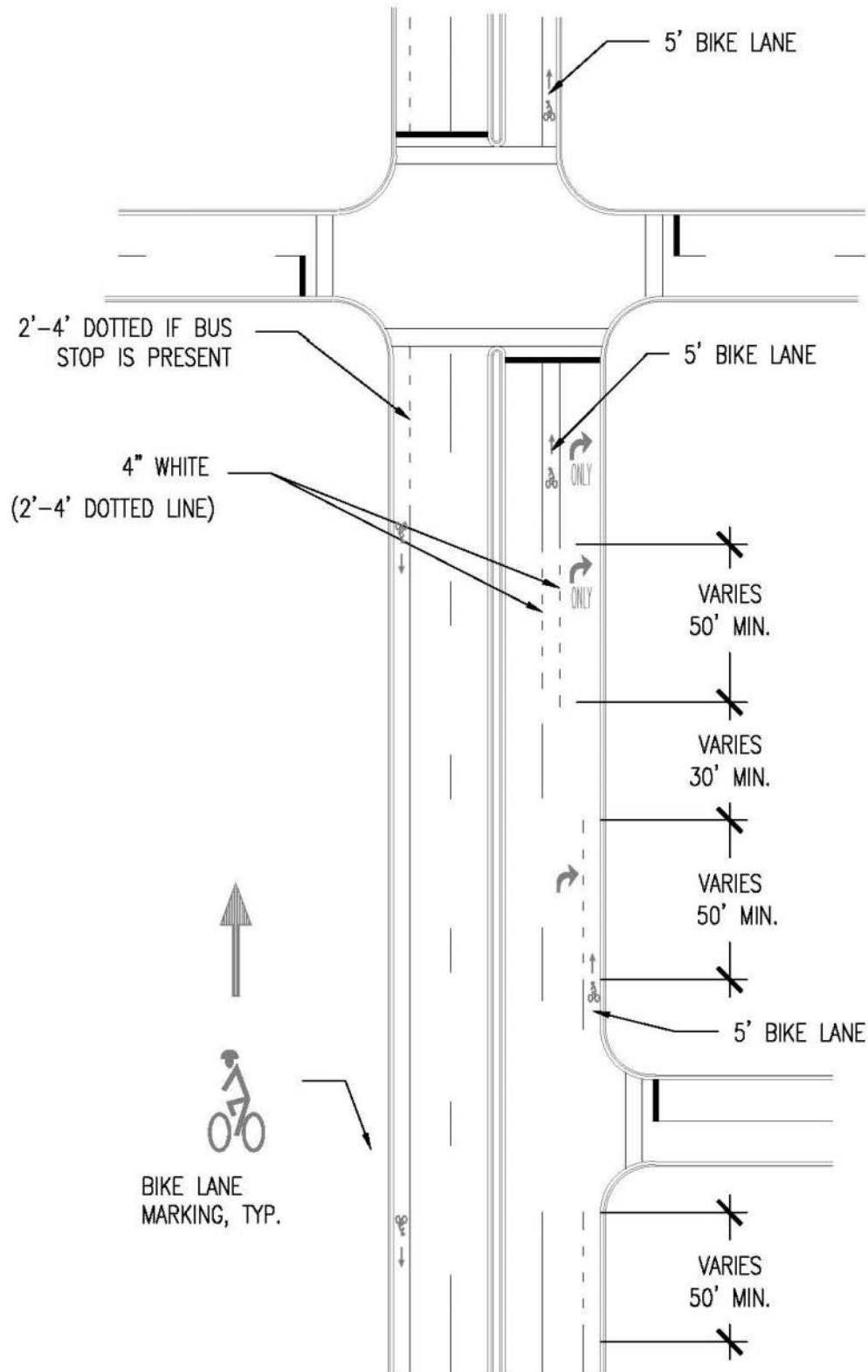



Figure 13-22 Typical Bike Lane - Tee Intersection, Right Turn Must Turn Right, Bus Stop

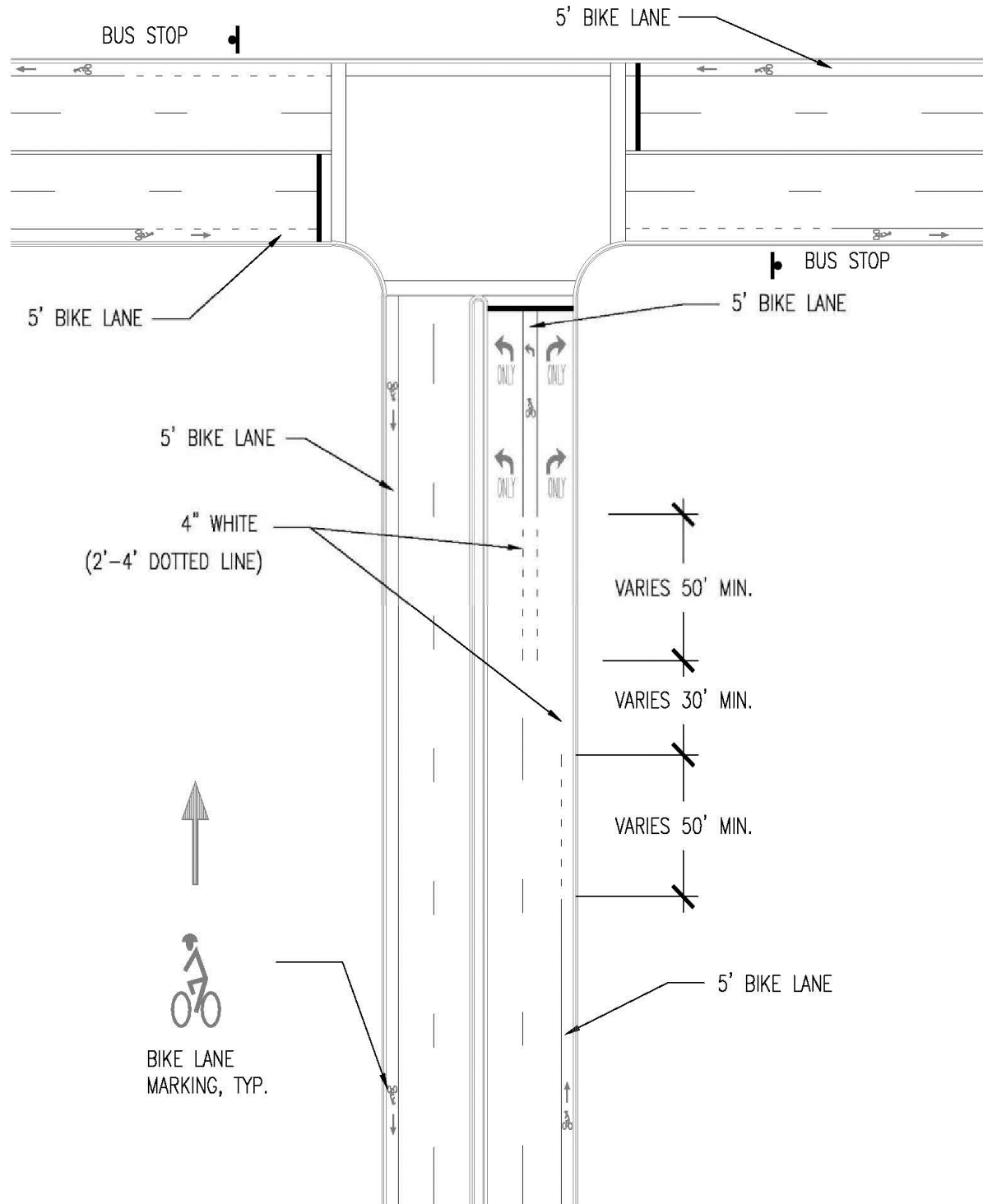



Figure 13-23 Typical Bike Lane - Tee Intersection, Right-Turn Lane, Bus Bay

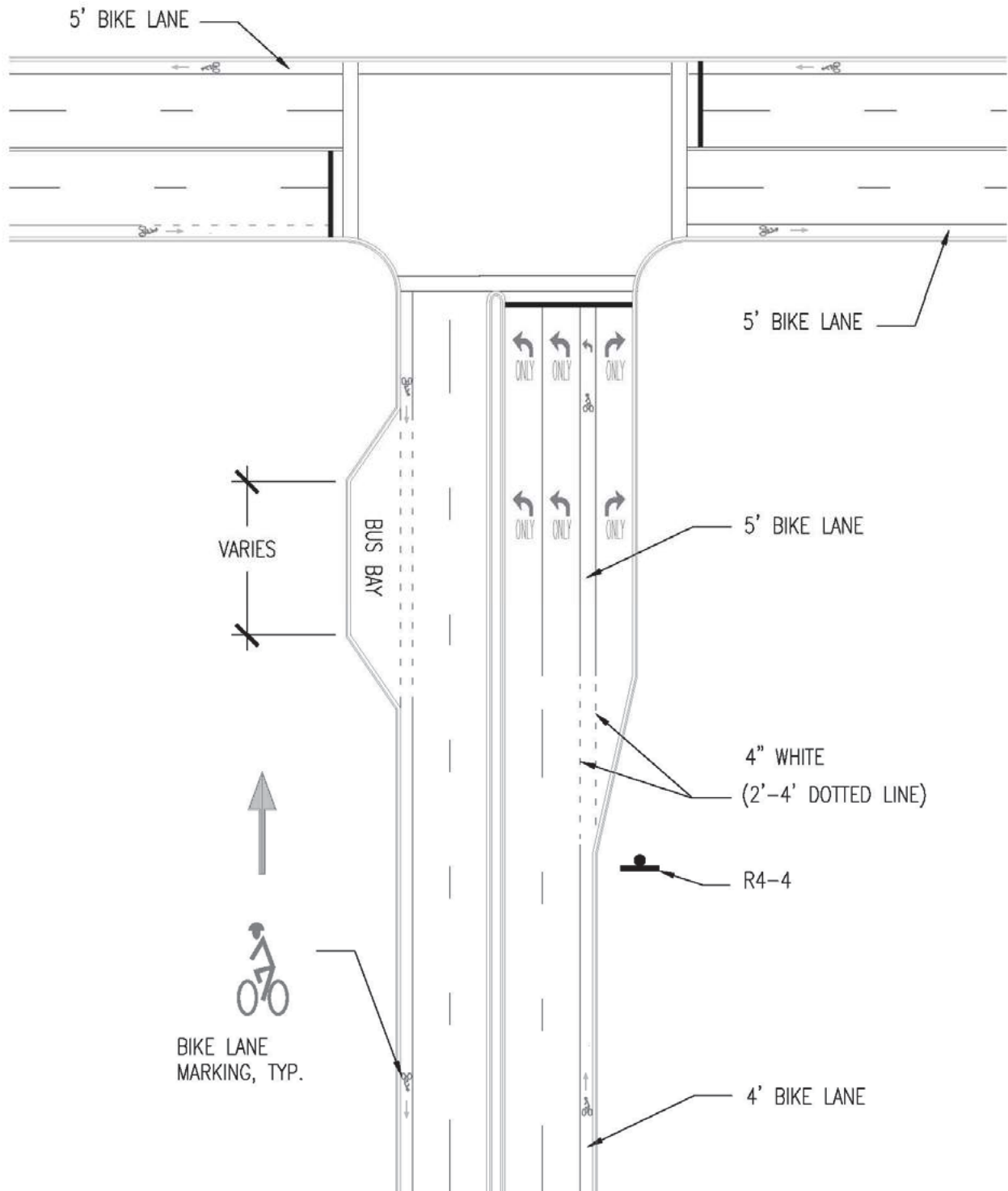



Figure 13-24 Typical Bike Lane - Compact Interchange

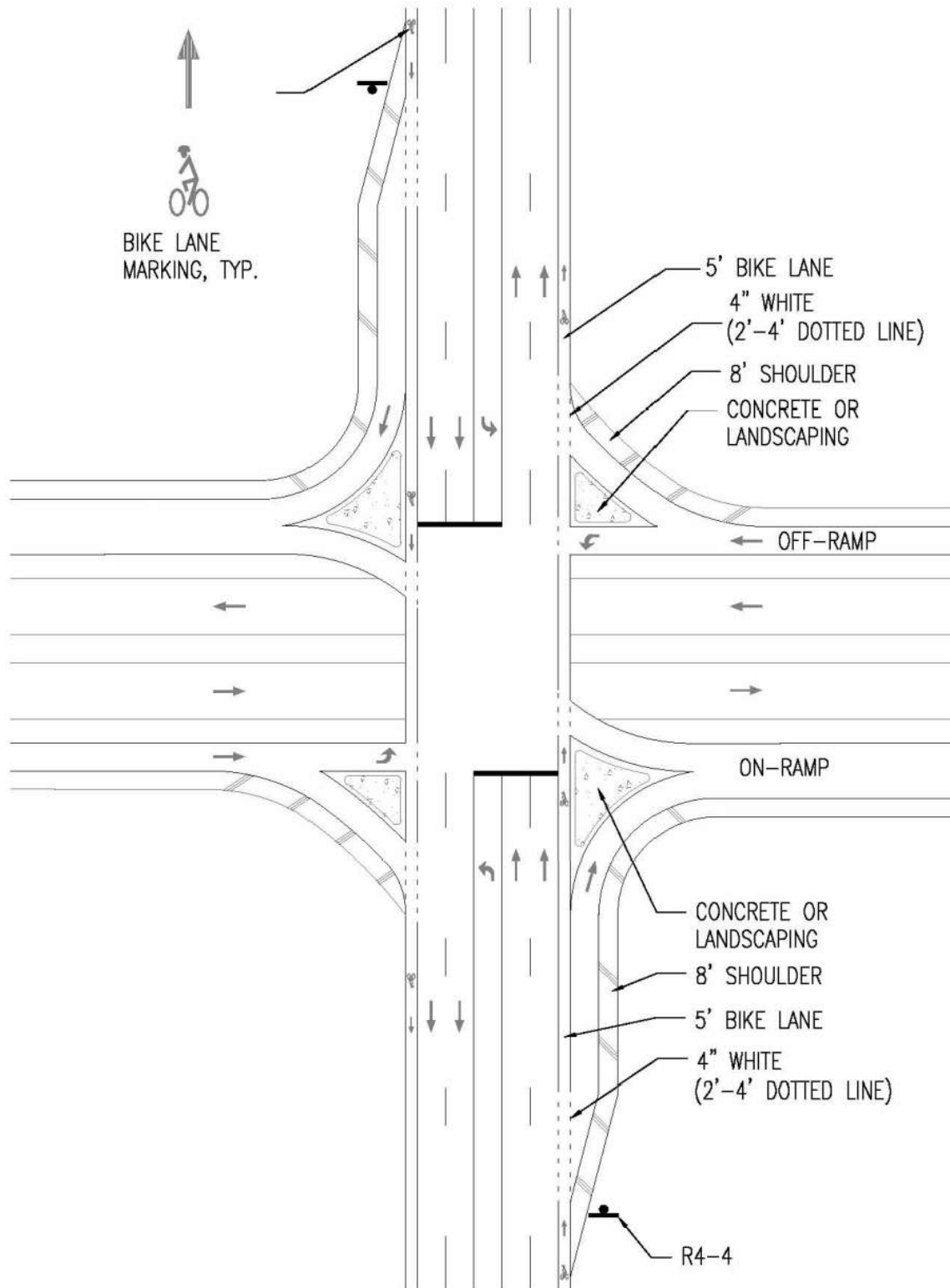



Figure 13-25 Typical Bike Lane - Rural Interchange

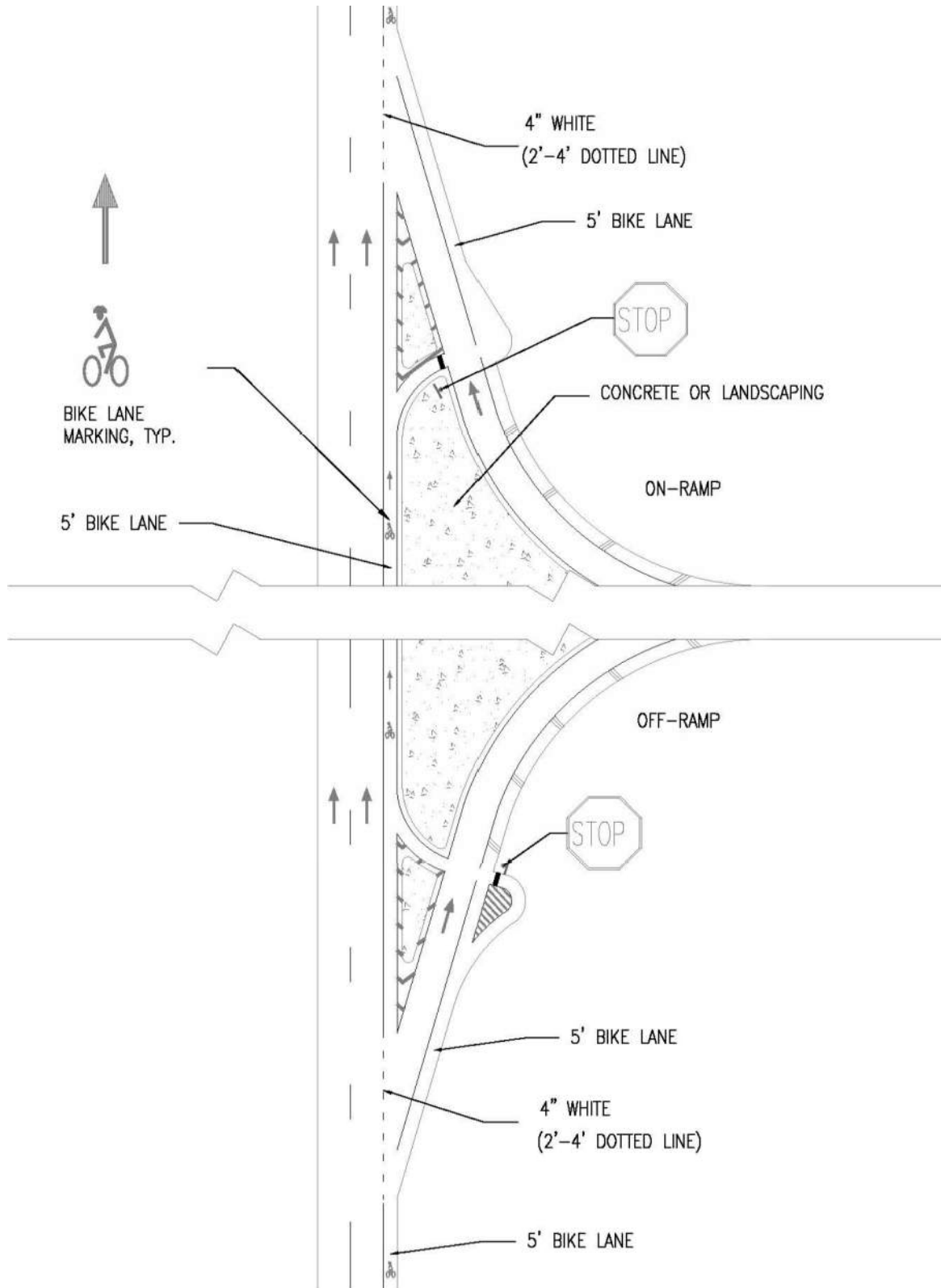
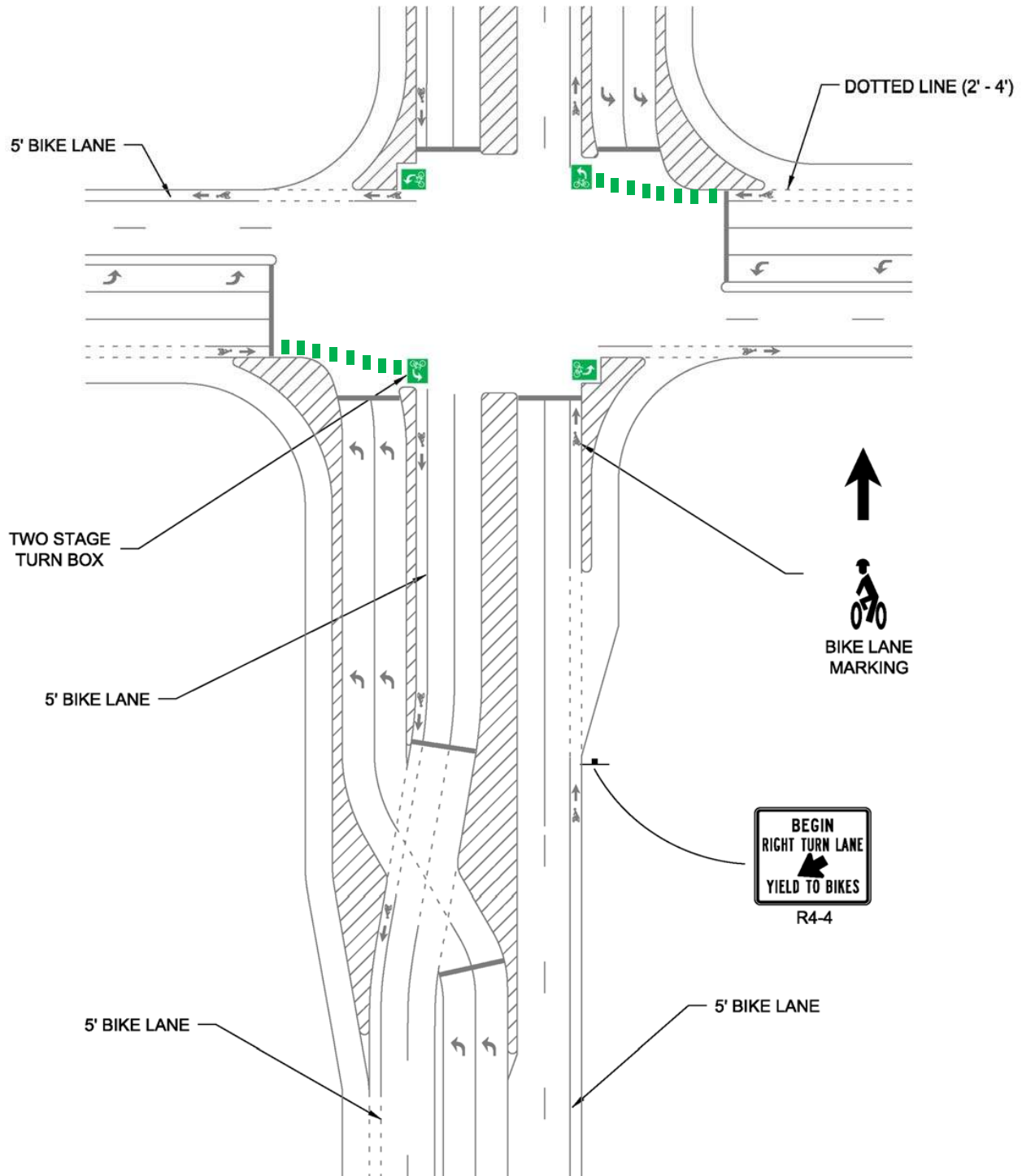



Figure 13-26 Typical Bike Lane - Continuous Flow Intersection



13.2.7.4.2 Two-Stage Turn Queuing Box

Making a left turn by merging across traffic to a left-turn lane may be inconvenient, uncomfortable, or unsafe for bicyclists. The Colorado Revised Statutes (C.R.S. Section 42-4-



1412(8)(a)) allows a bicyclist to turn left by merging to a left-turn lane and turning just as any other vehicle, or by making a two-stage left turn as follows and as shown in Figure 13-27:

- A person riding a bicycle or electrical assisted bicycle intending to turn left shall approach the turn as closely as practicable to the right-hand curb or edge of the roadway. After proceeding across the intersecting roadway to the far corner of the curb or intersection of the roadway edges, the bicyclist shall stop, as much as practicable, out of the way of traffic. After stopping, the bicyclist shall yield to any traffic proceeding in either direction along the roadway that the bicyclist had been using. After yielding and complying with any official traffic control device or police officer regulating traffic on the highway along which the bicyclist intends to proceed, the bicyclist may proceed in the new direction.¹

Figure 13-27 Common Maneuvers for Bicyclists Turning Left at an Intersection

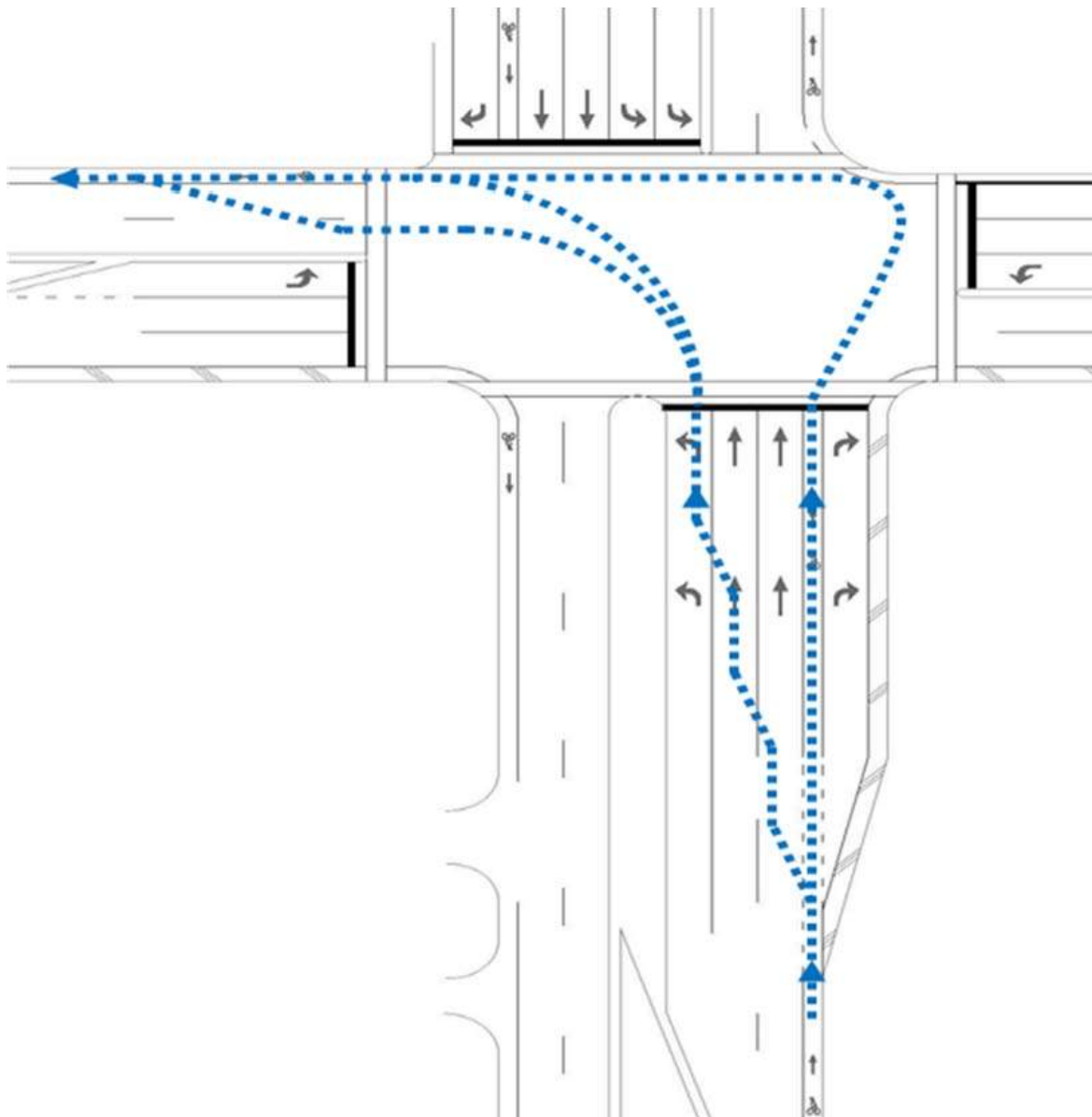

A two-stage turn queuing box is a designated area at an intersection where a bicyclist can wait before proceeding in a different direction of travel. It facilitates the two-stage turn described in the statutes. A two-stage turn queuing box should be located outside of the path of turning traffic so that it does not conflict with the right turn on red movement. A NO TURN ON RED (R10-11) sign should be installed where a two-stage turn queuing box is not located outside the path of right-turning traffic. A two-stage turn queuing box should be located downstream of the crosswalk and stop line. A bicycle symbol should be placed in the two-stage turn queuing box oriented in the direction in which the bicyclists enter the box, along with an arrow showing the direction of turn (Figure 13-28).

Figure 13-28 Two-Stage Left-Turn Box

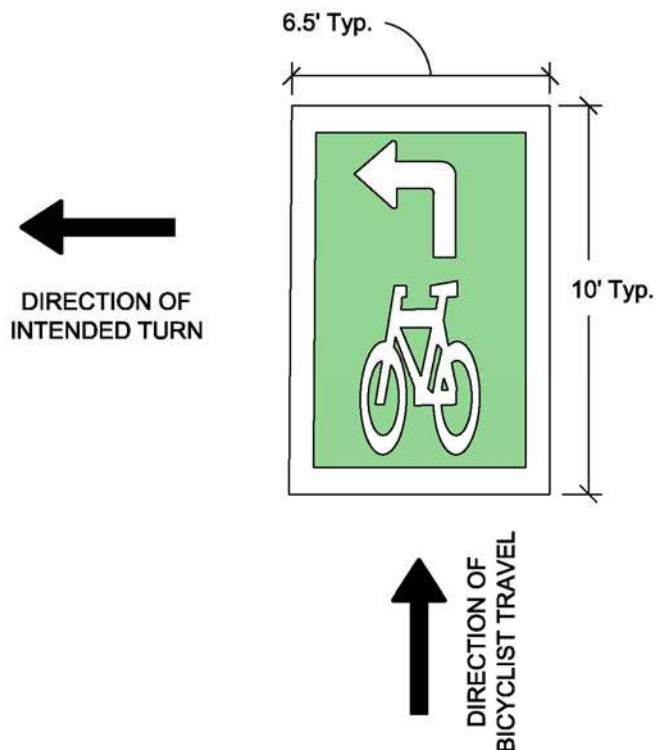

Passive detection of bicycles in the two-stage turn queuing box should be provided if detection is required to actuate the signal which allows bicyclists to cross. A two-stage turn queuing box is most commonly used for left turns, but it may be used for right turns from the left side of a one-way roadway. Green-colored pavement may be used within the two-stage turn queuing box.

Two-stage bike boxes at an intersection are shown in Figure 13-29.

Figure 13-29 Example of Two-Stage Turn Queuing Box at an Intersection

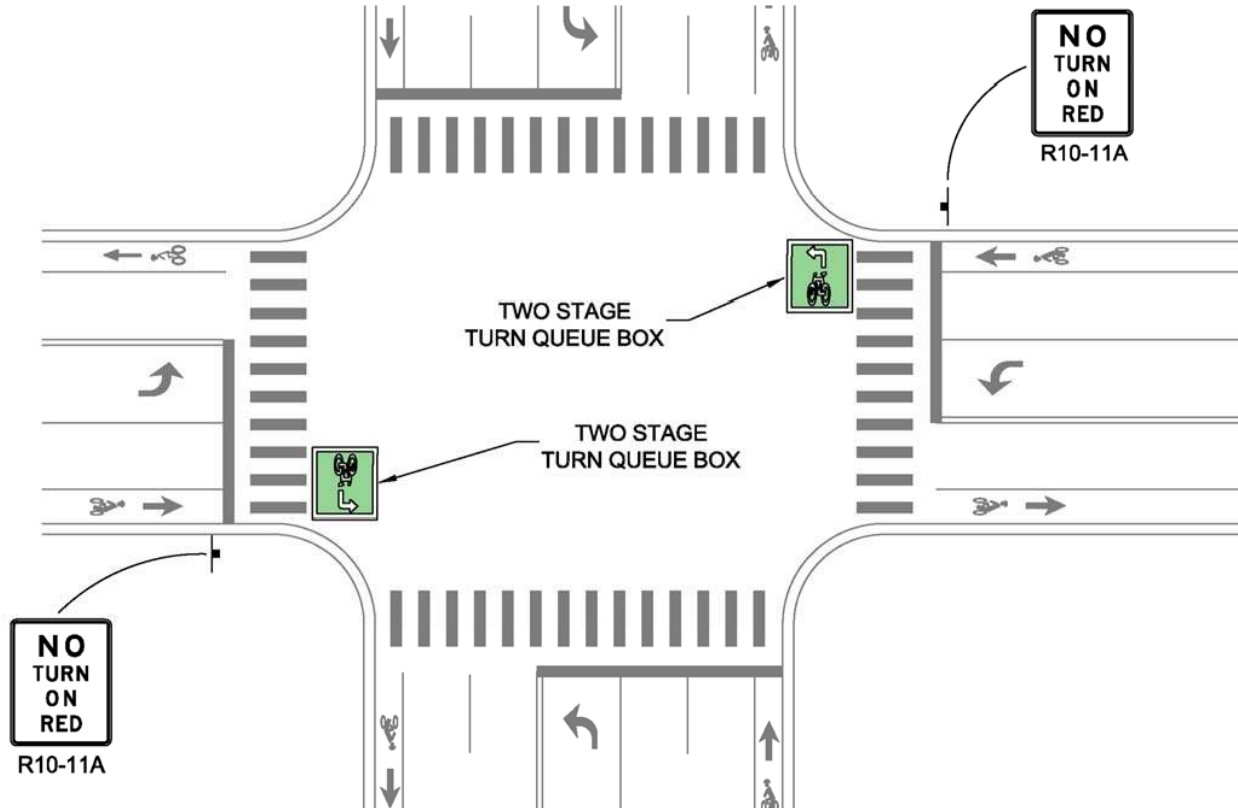

13.2.7.5 Buffered Bike Lanes

Increasing the lateral separation between motor vehicles and bicycles increases comfort for bicyclists. Where space is available, bike lanes can be improved through the provision of a painted buffer between the bike lane and the adjacent general-purpose lane or parking lane by a pattern of standard longitudinal markings. Buffered bike lanes appeal to a wider bicyclist user group because they provide greater shy distance between motor vehicles and bicyclists, and reduce the possibility of a wide bicycle lane being misconstrued as a travel or parking lane.

The buffer markings consist of two longitudinal white lines and may incorporate an interior diagonal cross hatch or chevron (Figure 13-30). These transverse markings shall be included when the buffer space is greater than 3 feet in width. The minimum buffer width should be no less than 18 inches. The spacing for transverse markings will vary based upon the speed of the adjacent roadway, on higher speed roadways less frequent hatching may be needed. The width of the buffer will vary depending upon conditions such as motor vehicle speed, percentage of heavy vehicles, roadway cross slopes, and desired level of accommodation for bicycles. Guidelines for buffered preferential lanes can be found in the MUTCD in Section 3D-01. The FHWA *Separated Bike Lane Planning and Design Guide* (FHWA, 2008) and the NACTO *Urban Bikeway Design Guide* (NACTO, 2013) offer further design guidance for buffered bicycle lanes.

Figure 13-30 Buffered Bike Lane

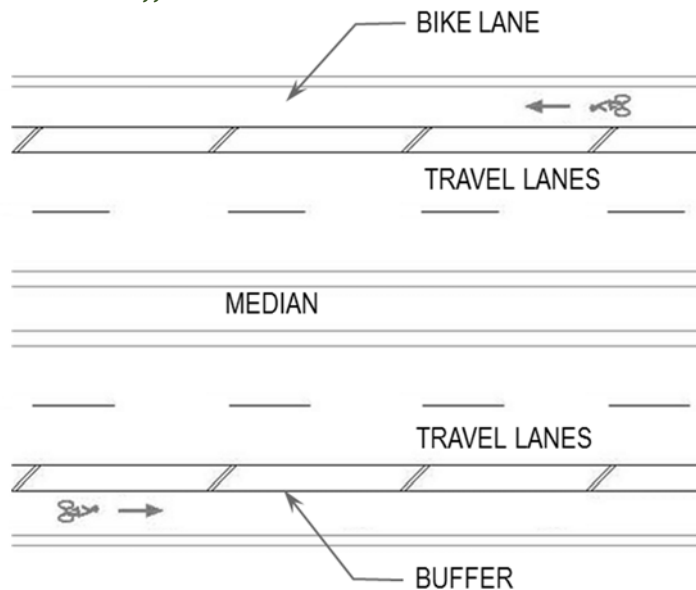

A buffer can also be provided between a parking lane and a bike lane to reduce the potential for a bicyclist to ride in a parked car's door swing zone. A buffer area provides a greater separation between the bicycle lane and adjacent lanes than is provided by a single normal or wide lane line.

Guidelines for buffered bicycle lanes can be found in the MUTCD Section 3D-01. Further design guidance for buffered bicycle lanes can be found in the FHWA *Separated Bike Lane Planning and Design Guide* (FHWA, 2008) and the NACTO *Urban Bikeway Design Guide* (NACTO, 2014)

13.2.7.5.1 Buffered Bike Lanes at Intersections

Buffered bike lanes at intersections should be striped similarly to non-buffered bike lanes at intersections. As described in Section 13.2.7.4, prior to intersections, the bike lane markings are discontinued or dotted to support the legal requirements for turning motorists and to help inform bicyclists that they are entering a potential conflict area. Figure 13-31 illustrates a buffered bike lane at an intersection where the buffer and bike lane width become a right-turn lane.

At locations where it is desirable to include a right-turn lane, but there is not enough cross section width to provide both a bike lane and a turn lane, SHARED LANE MARKINGS can be used to guide bicyclists to the left side of a designated right-turn lane (Figure 13-32). This option should only be used where there is a receiving bike lane or shoulder on the far side of the intersection.



Figure 13-31 Detail of Typical Buffered Bike Lane Designation

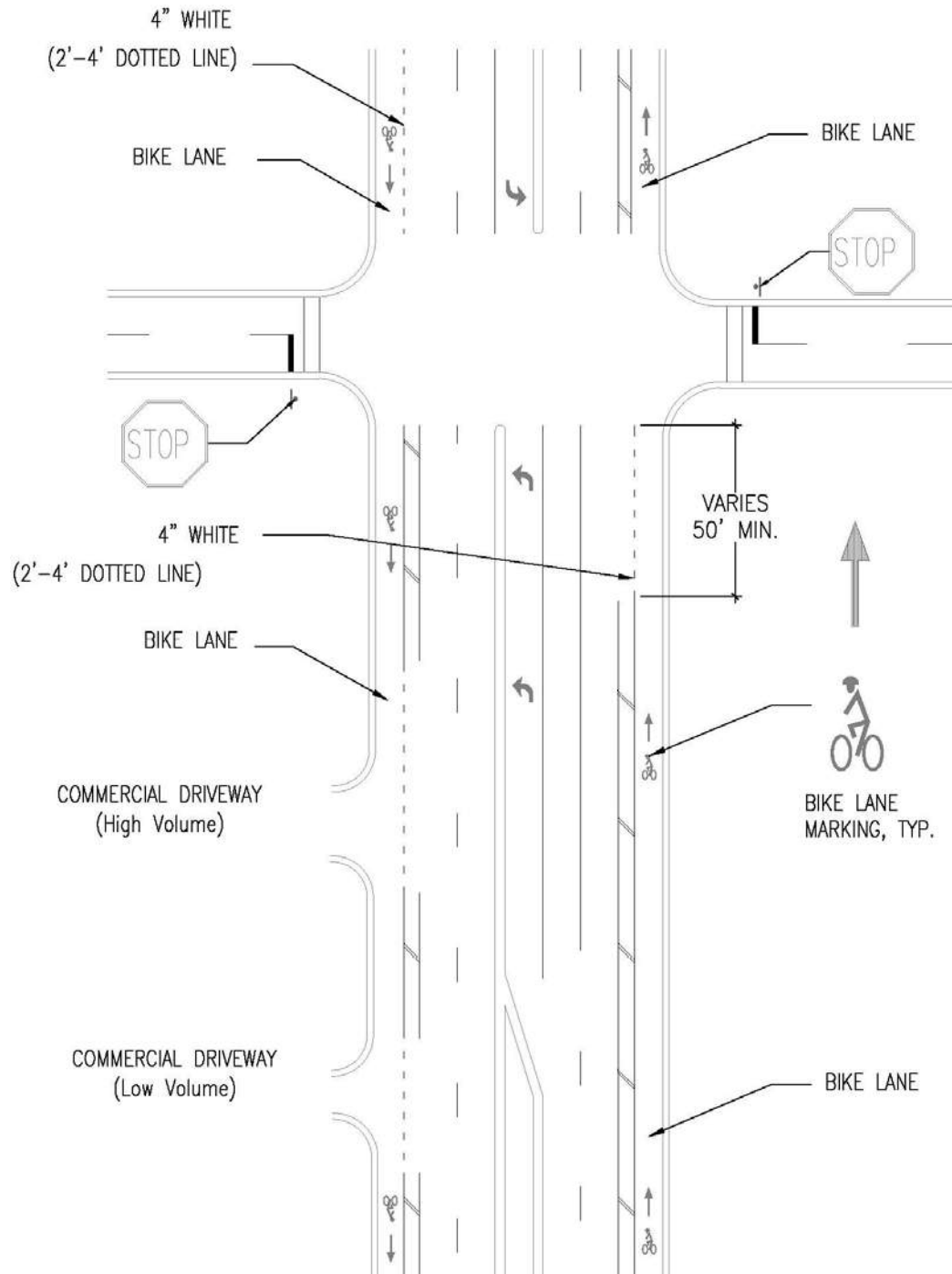
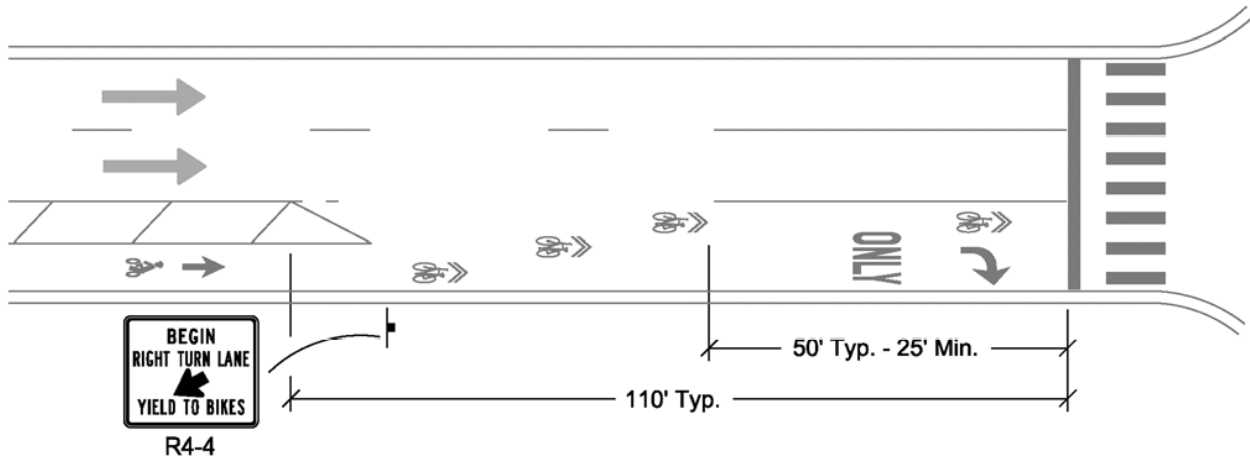

Figure 13-32 Sample Buffered Bike Lane Transition at Intersection with Right-Turn Lane



13.2.8 Detection of Bicycles at Signalized Intersections

Various detection technologies can be used to detect bicyclists at intersections. The most common in Colorado are video, radar, infrared, and loop detection.

- Video detection is effective if bicyclists are using a travel lane. In addition, it is a good practice to provide a bike box, marking, or signage where the bicyclist is to stop and be detected. This may exclude right-turn lanes but should include left-turn lanes.
- Radar detection is a newer form of detection that has the capability to distinguish between user types. If signal operations require a distinction between bicyclists and motorists, radar detection systems should be used.
- Infrared detection is a common detection method that allows bicyclists to be detected through fog, snow, and other environmental factors that can impair the ability of video. This perception results from bicyclists not waiting in an optimal spot for detection (SRF, 2003).
- Calibrating loop sensitivity to detect bicycles is a principal challenge of signal hardware design, which has led to development of numerous loop configuration solutions. The 6-foot-by 40-foot quadrupole loops shown on standard drawing S-613-43 Traffic Loop and Miscellaneous Signal Details should be capable of detecting bicycles.

There are two basic strategies to improve detection of bicycles: to direct bicyclists to the area of optimal loop sensitivity, or to place new loops in spots where cyclists are likely to be waiting, such as in the bike lane or at the right edge of the pavement. It is recommended that these strategies be used before investing in a new technology. The technology already in place at many intersections should be capable of detecting bicycles. New loops should be of a type that detect bicycles.

The simplest way to detect bicycles at traffic signals is to mark the spot on the roadway where the loop will best detect the bicycle. The MUTCD provides for a symbol that may be placed on the pavement to indicate the optimum position for a bicyclist to actuate the signal for conventional

inductive loops (MUTCD). Used in conjunction with the Bicycle Signal Actuation sign (R10-22) (MUTCD) (Figure 13-33), this symbol increases the ability of the loops to detect bicycles.

Figure 13-33 Bike Detection Symbol and Bicycle Signal Actuation Sign



13.2.8.1 Signal Detection in Bike Lanes

Signal detection within a bicycle lane should be considered where a signal change is needed to allow a bicyclist to travel safely through an intersection.

A successful loop type for bike lanes is a quadrupole loop of reduced size (2 feet x 10 feet). These loops are highly sensitive to objects in the area immediately above them, but detection falls off rapidly outside of this sensitivity field; this means that cars in adjacent lanes will not be detected. Refer to Section 13.2.7 for more alternatives on bike detection technologies.

Bike phase signal activations can be used at busy intersections with high bicycle volumes. The “bike phase” of the signal is activated by the bicycle lane detection.

13.2.8.2 Signal Timing for Bicycles

The MUTCD requires that traffic signal timing and actuation be reviewed and adjusted to consider the needs of bicyclists. Meeting the needs of bicyclists on bikeways means providing adequate minimum green times and adequate change periods.

The minimum green time allows bicyclists to start from a stopped condition, cross, and clear the intersection. For the crossing of narrow roadways, bicyclists may not accelerate to full speed before clearing the intersection. On wider roadways, bicyclists may accelerate to full speed and



may require additional time to finish crossing and clear the intersection. The equations to calculate minimum green time are as follows:

$$G_{min} = 1.0 + 1.15\sqrt{W + 6} \quad \text{Where } W \leq 72 \text{ feet}$$

$$G_{min} = 10.8 + \frac{(W-72)}{14.7} \quad \text{Where } W > 72 \text{ feet}$$

and

G_{min} = minimum green time (sec)

W = width of intersection (ft)

Typically, the minimum change period is calculated using the following equation:

$$CP = \left[t + \frac{1.47v}{2(a + 32.2g)} \right] + \left[\frac{W + L_v}{1.47v} \right]$$

Where:

CP = change period (yellow change plus red clearance intervals), (sec)

t = perception-reaction time to the onset of a yellow indication, s, assume 1 (sec)

v = approach speed (mph)(assume 10 MPH for a bicycle)

a = deceleration rate in response to the onset of a yellow indication, (ft/sec), (assume 5 ft/sec for a bicycle)

g = grade, with uphill positive and downhill negative (percent grade / 100), (ft/ft)

W = width of intersection (ft)

L_v = length of vehicle, (ft) (assume 6 ft for bicycle)

At a wide intersection, the clearance interval for motorists may not be long enough to allow bicyclists to cross the intersection. Advance detection in bike lanes or on shoulders can extend the green time so that bicyclists can clear the intersection before the cross traffic gets a green signal. An alternative is a bicycle-specific signal (refer to Section 13.3.16.8) with a plaque that states “Bicycle Signal”.

At installations where visibility-limited signal faces are used, signal faces shall be adjusted so bicyclists can see the signal indications. If the visibility-limited signal indications cannot be adjusted for the bicyclist, separate signal indications shall be provided for the bicyclist.

13.2.9 Bike Lanes at Roundabouts

Bike lanes are not carried through roundabouts. The MUTCD states that bike lane markings should stop at least 100 feet prior to the approach of a roundabout. At the end of a bike lane, a pathway must be provided for bicyclists to exit the roadway if they choose. A SHARED LANE MARKING may be used through the roundabout. Figure 13-34 is an example of a multilane roundabout with a bike lane.



Figure 13-34 Multilane Roundabout

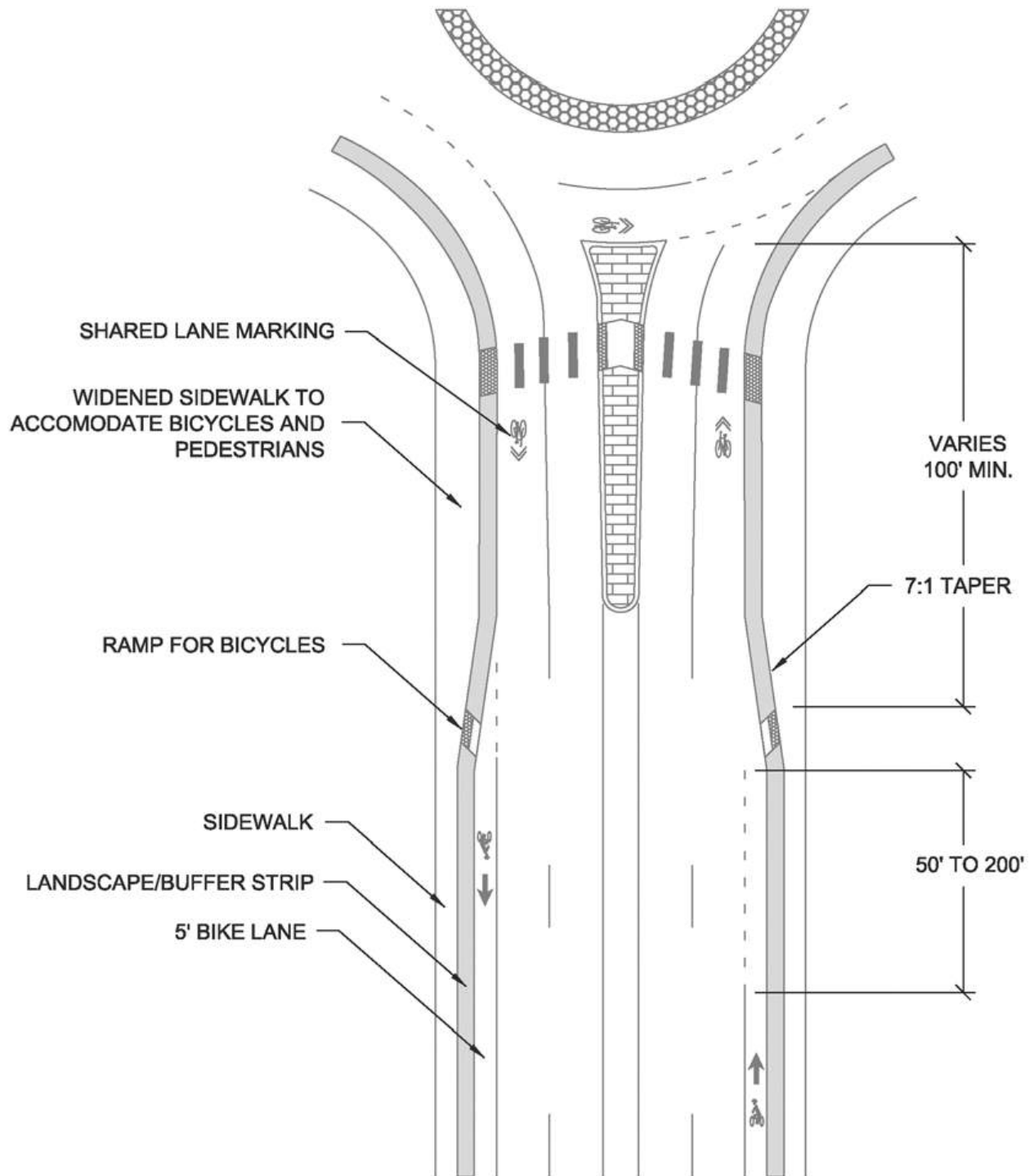

13.2.10 Separated Bike Lanes (Cycle Track)

Separated bike lanes, also known as cycle tracks, are bicycle lanes that are separated from general travel lanes and sidewalks. They are not the same as shared-use paths because separated bike lanes are bicycle-only facilities. They are distinct from buffered bike lanes because there is a physical separator, such as a raised island or on-street parking, between the bike lane and outside travel lane. Operationally, two-way cycle tracks can be very challenging, particularly at intersections with driveways and streets.

For guidance on the design of cycle tracks, refer to the *AASHTO Guide for the Development of Bicycle Facilities* (AASHTO, 2012), the *FHWA Separated Bike Lane Planning and Design Guide* (FHWA, 2008), and the *NACTO Urban Bikeway Design Guide* (NACTO, 2014).

13.2.11 Bicycle Boulevards

A bicycle boulevard is a local street or series of contiguous street segments designed to prioritize bicycle travel and discourage motor vehicle throughput and speeds. Local vehicle access is maintained along the bicycle boulevards. Bicycle boulevards are not used on CDOT-owned roadways. However, they may be used to improve an adjacent, alternative route where bicycle accommodation cannot be met on the CDOT roadway (refer to Section 13.2.12).

Bicycle boulevards are often used on low-volume, very low speed local streets. SHARED LANE MARKINGS may be used along bike boulevards. Often bicycle boulevards have bicycle-friendly traffic calming or treatments (e.g., speed cushions, mini traffic circles, chicanes) to reduce motor vehicle speeds along the roadway. Some portions of a bike boulevard may be on busier roads with bike lanes. To discourage through movements of motorized vehicles, traffic diverters should be used at intersections. Bicycle boulevards can also be created by connecting the ends of cul de sac roadways with a grid pattern as it reduces turning movements and makes the route more intuitive. Because bike boulevards typically serve as bike routes, wayfinding signage should be provided.

One of the challenges to implementing bike boulevards is how to safely accommodate bicyclists at the crossing of major roadways. At intersections, the bicycle boulevard should be given priority over side streets. Improvements to signal timing and detection or enhanced crossing treatments (e.g., activated beacons, raised medians) where there are no traffic signals make a bicycle boulevard more appealing to bicyclists.

Another challenge is that residents who live along the route may be opposed to altering the facility to accommodate the boulevard. Motorists who travel the route may oppose the modification because of the altered travel patterns. Designers should be aware of these challenges and plan for early and sustained public outreach to the neighbors, communities, and municipalities within the project's area.

13.2.12 Alternative Routes

In some instances, it may not be possible to improve the roadway to accommodate bicyclists. In these cases, it may be possible to improve an adjacent street as an alternative route for bicyclists. Alternative routes could be improved using some of the treatments described in this



chapter. The land use context and transit access along the parallel route should appeal and attract bicyclists from the primary route. Additional signage should also be considered to direct the bicyclists to the alternative route. Another key factor for parallel routes is the distance. Research indicates that for an alternative low-stress route to be viable, the trip length should not increase more than 30% (Broach et al, 2012).

Several factors must be addressed when considering whether an alternative route provides a suitable accommodation for bicyclists:

- **Geometric delay.** This is the delay caused to bicyclists by increased distance they must travel to use the alternative route. If an alternative route significantly increases the distance and time a bicyclist must travel to access a destination, it is less likely to be used.
- **Control delay.** This is the delay caused by increasing the number of STOP signs or red traffic signals along a route. Often the primary corridor is given most of the green time at signals and does not often have to stop at minor street intersections. If the alternative route is a local street with stops at every cross street and gets minimal green time at signalized intersections, bicyclists are less likely to use it.
- **Access to destinations.** An alternative route must provide access to the trip destinations along the primary corridor, or it will not be a practical option for bicyclists.
- **Safety.** An alternative route considered for improvement should be subject to a safety assessment. This would include reviewing crashes along the route as well as identifying potential safety concerns associated with accessing the primary corridor from the alternative route.

13.2.13 Other Roadway Considerations

13.2.13.1 Roadway Cross Slope

The typical cross slopes for roadways usually accommodate bicyclists. Cross slopes of 5% or less are desirable for bicycles. However, the *AASHTO Guide for the Development of Bicycle Facilities* (AASHTO, 2012) allows superelevation rates up to 8%.

13.2.13.2 Drainage Inlets and Utility Covers

Placement of drainage inlet grates should be avoided within a bicycle facility regardless of whether that facility is a bike lane, shoulder, or shared lane. If this is not possible, drainage inlet grates should be safe for bicyclists. Utility covers and drainage grates should be installed to be flush with the pavement. The construction of new roadway facilities should consider the use of curb inlets rather than gutter pan drop inlets.

Drainage inlet grates with slots or gaps parallel to the roadway can trap a bicycle's front wheel and seriously damage the bicycle or injure the bicyclist. These types of grates should be replaced with bicycle-safe grates that maintain the required hydraulic capacity for the inlet (Figure 13-35).

A bicycle-safe grate should have, at a minimum, bars perpendicular to the travel direction at a 4-inch center-to-center spacing

For safety considerations, a utility cover or drainage inlet located on a bicycle facility that has a gap or opening parallel to the roadway should be replaced or corrected as soon as possible. If a drop inlet with parallel slots cannot be replaced, an obstruction marking should be placed on the pavement prior to the inlet (Figure 13-36).

Figure 13-35 Bicycle Compatible Drainage Grates

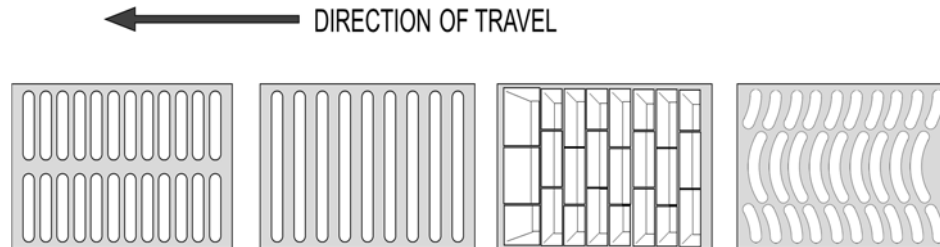
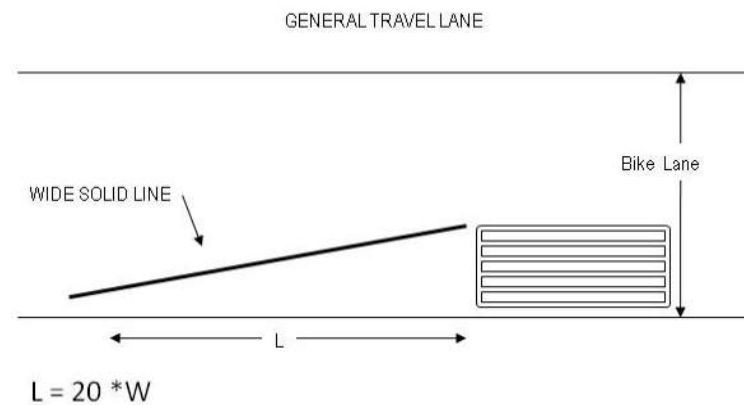

Figure 13-36 Bicycle Obstruction Marking in Advance of a Drop Inlet



Where W = width of inlet

13.2.13.3 Railroad Crossings

Ideally, travel ways and bicycle facilities should cross rail lines between 60 and 90 degrees so that bicyclists can avoid catching their wheels in the flange and lose their balance. The design of the crossing should also evaluate the fastest path a bicyclist can take through the crossing.

At railroad crossings with crossing angles less than 45 degrees, it is recommended that the bicycle path be modified so that the bicyclist is able to cross the tracks at a right angle. The simplest approach is to provide additional pavement width at the crossing. Figure 13-37 shows two scenarios with potential skewed crossing treatments. Pavement markings can be provided to direct bicyclists to the preferred path of travel. Additionally, SKEWED CROSSING warning signs (W10-12) should be considered for the approach to the crossing.

Figure 13-37 Potential Treatments at a Skewed Railroad Crossing

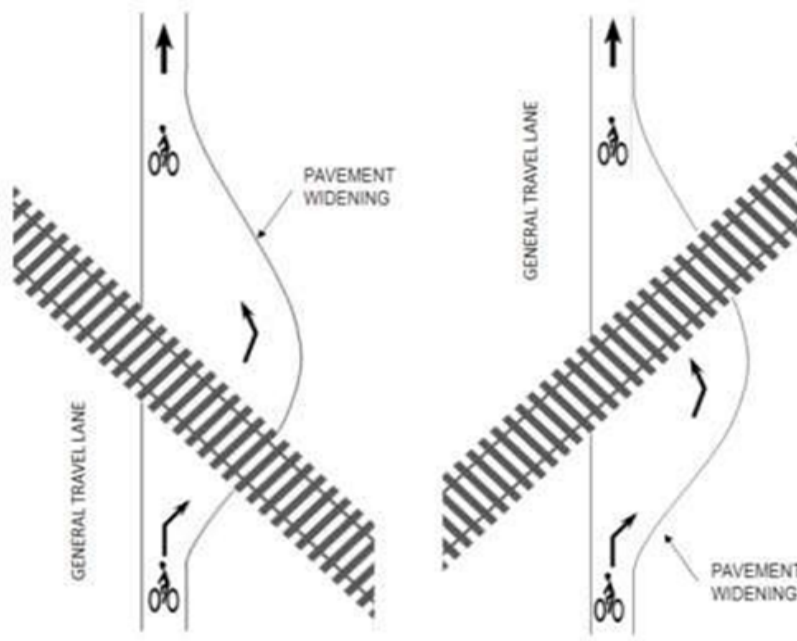

13.2.13.4 Bridges and Tunnels

The FHWA *Accommodating Bicycle and Pedestrian Travel: A Recommended Approach Policy Statement* (FHWA, 2010) states, “A bridge that is likely to remain in place for 50 years should be built with sufficient width for safe bicycle and pedestrian use (sidewalks and shoulders) in anticipation that facilities will be available at either end of the bridge even if that is not currently the case.”

Bridge designs should provide adequate width for current and future anticipated bicycle and pedestrian volumes. Widths should meet or exceed the minimums for shoulders, bike lanes, separated bike lanes, and shared-use path design discussed in other sections. Additionally, the operating space of a bikeway recognizes that bicyclists will not travel immediately against a railing, barrier, or other continuous vertical element and a shy distance should be provided.

Bridge railings need to be taller to prevent a bicyclist that hits the barrier from going over the barrier. The barrier should be at least 42 inches tall.

Tunnels should be designed to accommodate bicyclists and pedestrians. The vertical clearance should be at least 10 feet, however, in constrained locations where the ends of the tunnel are visible from either side, the vertical clearance may be as low as 8 feet.

Lighting in tunnels should be provided to allow users to see the paved surface and identify any hazards ahead of them, allow users to identify others around them including their relative speed and direction of travel, illuminate walls and other fixed objects, and create a visually appealing or interesting space to reduce the sense of enclosure.

13.3 Shared-Use Paths

Shared-use paths are physically separated from motorized vehicular traffic by a physical barrier or clear space. They are often on their own alignments but may be located within the right of way of an adjacent roadway.

Shared-use paths are intended for use by many modes (e.g., pedestrians, persons with disabilities, bicyclists, etc.) and must be made ADA compliant to the maximum extent feasible (refer to Section 13.3).

13.3.1 Surface Treatments

Shared-use paths typically are surfaced with hot mix asphalt (HMA) or concrete pavement. HMA may be a less expensive alternative, but its life span is shorter and maintenance costs tend to be higher over the life of the pavement compared to concrete pavement. Concrete pavement tends to resist deformation from vegetation better than HMA and has a more appealing appearance.

13.3.1.1 Paved Shared-Use Paths

Most CDOT shared-use path projects are paved. Asphalt and Portland cement concrete are the two most common surfaces for shared-use paths. Asphalt may be a less expensive alternative, but its life span is shorter and maintenance costs tend to be higher over the life of the pavement when compared to concrete pavement. Additionally, concrete pavement tends to resist deformation and vegetation growth better than asphalt and is more visually appealing. For rigid pavement design information, refer to the CDOT *M-E Pavement Design Manual* (CDOT, 2021). The Materials Engineer should be consulted for flexible pavement design information. On Portland cement concrete pavements, the transverse joints should be saw cut, rather than tooled, to provide for a smoother riding surface. Skid resistance should not be reduced, and broom finish or burlap drag surfaces should be provided. Paved paths should be designed to sustain vehicle loads for occasional maintenance, patrol, emergency or other vehicles that are permitted to use the path.

Where paved shared-use paths cross unpaved roadways or driveways, the roadway or driveway should be paved 20 feet on each side of the shared-use path to minimize debris accumulation on the path.

13.3.1.2 Unpaved Shared-Use Paths

In areas where path use is expected to be primarily recreational, unpaved surfaces may be acceptable. Materials should be chosen to ensure the ADA requirements for a firm, stable, slip-resistant surface are met. Even when ADA criteria is met, some users, such as in-line skaters, kick scooters, and skateboarders, may be unable to use unpaved shared-use paths.

For unpaved shared-use paths, grades of greater than 3% may result in erosion problems and bicycle handling difficulty. Additionally, snow plowing may be impractical on unpaved shared-use paths.

13.3.2 Design Speed

Similar to roadways, the design speed selected for shared-use paths dictates other design criteria (e.g., sight distance, curve alignments). Consequently, the selection of an appropriate design speed is important to maximize the flexibility of a shared-use path.

Design speeds range from 12 to 30 mph. Increments of 2 mph should be used for design speeds less than 20 mph and increments of 5 mph should be used for design speeds above 20 mph.

An 18 mph design speed is generally sufficient for most shared-use paths in relatively flat areas (generally less than 2% grades). If it is expected that there is significant use by recumbent bicyclists, the minimum design speed should be to 18 mph (FHWA, 2004). Additionally, many e-bike users may travel at speeds of 20 mph or more on flat terrain. However, the presence of e-bikes does not mean that a 20 mph design speed must be selected for all bikeways.

Design speeds lower than 18 mph may be used in areas where the bicycle users are expected to be made up of lower-speed users, such as children. A design speed less than 14 mph should be used only in unusual circumstances. Justification based upon environmental context and user types should be provided when using a design speed less than 14 mph.

Lowering bicyclist and motorist operating speeds allows bicyclists and motorists more time to perceive potential conflicts. Geometric design and traffic control devices should be used in advance of crossing points or hazards (refer to Section 13.3.10.6).

Where sustained grades exceeding 4% in excess of 300 feet in length are required, a higher design speed should be used. Design speeds should be based upon the anticipated travel speeds of bicyclists traveling downhill. The maximum design speed used in all but the most unusual cases should be 30 mph.

13.3.3 Sight Distance

As stated in Chapter 6 of this Guide, a critical element in assuring safe and efficient operation of a vehicle on a highway is the ability to see ahead. Sight distance is the distance along a roadway or path throughout which an object of specified height is continuously visible to a bicyclist. Sight distance of sufficient length must be provided to allow a bicyclist to avoid striking unexpected objects in the traveled way. In a vertical plane, this distance is dependent on the height of the bicyclist's eye above the road or path surface, the specified object height above the road surface, and the height and lateral position of obstructions such as cut slopes, guardrail, and retaining walls within the bicyclist's line of sight. Horizontal alignment, including the routing of a path around visual screens, can also impact sight distance and should be considered.

13.3.3.1 Stopping Sight Distance

Stopping sight distance is the sum of two distances:

- The distance a bicycle travels from the instant the bicyclist sights an object necessitating a stop to the instant the brakes are applied (brake reaction distance), and



- The distance required to stop the bicycle from the instant brake application begins (braking distance).

Stopping sight distance is measured from the bicyclist’s eyes (assumed to be 4.5 feet above the pavement) to an object flush with the surface of the shared-use path. If it is found that there is a high number of recumbent cyclists, an eye height of 2.8 feet should be used (FHWA, 2004). Distances greater than the minimum stopping sight distance provide an additional measure of safety and should be considered where practical.

On downhill grades, gravity acts against braking forces and increases the distance required to stop. On uphill grades, gravity reduces the distance required to stop. The effect of grades is represented in stopping sight distance values.

The equation for stopping sight distance, assuming a 2.5-second reaction time, is

$$S = 3.67V + \frac{V^2}{30(f + G)}$$

Where,

S = stopping sight distance (ft)

V = design speed (mph)

f = friction factor (assume 0.16 for a typical bicycle)

G = grade in (ft/ft)

Table 13-5 shows stopping sight distances for level roadways and roadways with grade for various design speeds. Refer to Chapter 6 for adjustments for grades.

Table 13-5 Stopping Sight Distance for Bicycles

Design Speed (mph)	Stopping Sight Distance (Design Values)						
	No Grade Adjustment	% Down Grade			% Up Grade		
--	--	3	6	9	3	6	9
8	43	46	51	60	41	40	38
10	58	63	71	85	55	52	51
12	75	81	93	113	70	66	64
14	93	102	117	145	86	82	78
16	113	125	145	181	104	98	93
18	134	150	175	221	123	116	110
20	157	176	207	264	144	135	127
25	222	253	301	390	202	187	176
30	298	341	411	539	268	247	231

13.3.3.2 Sight Distance on Horizontal Curves

Sight distance on horizontal curves on shared-use paths may be obtained with the aid of Figure 13-38 and Table 13-6. The line of sight is assumed to intercept the obstruction at the midpoint of the sight line and at the surface of the center of the inside lane. The middle horizontal sightline offset (HSO) is obtained from the equation in Figure 13-38 and from Table 13-6.

The stopping sight distance in Table 13-6 is the stopping sight distance determined using the equation or table from Section 13.3.3.1. The minimum radii for horizontal curves are addressed in Section 13.3.7.

Figure 13-38 Stopping Sight Distance on a Shared-Use Path Horizontal Curve

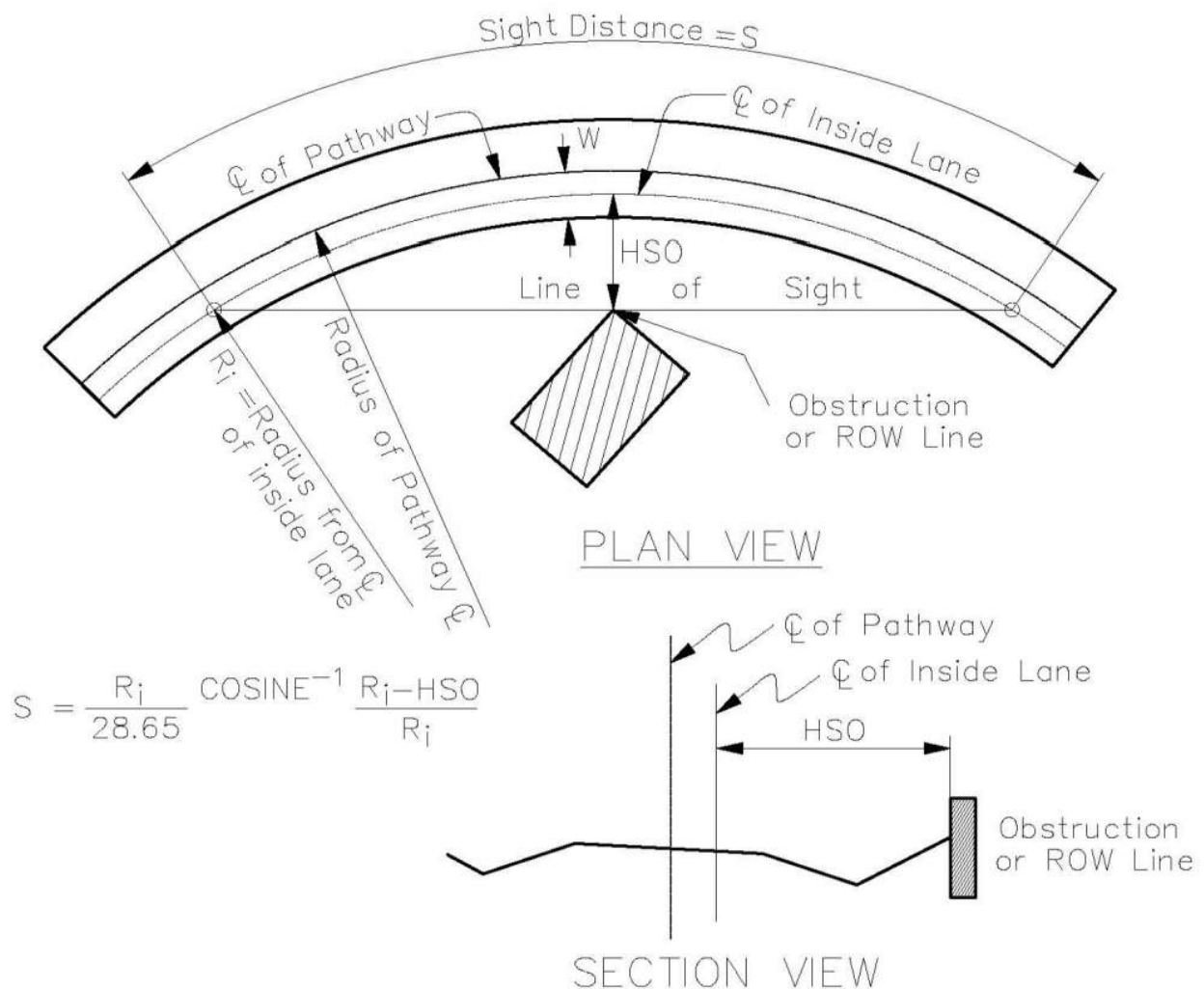



Table 13-6 Minimum Horizontal Clearance for Horizontal Sightline Offset for Horizontal Curves

		Stopping Sight Distance												
		20	40	60	80	100	125	150	175	200	225	250	275	300
Curve Radius (ft)	15	3.2	11.5	21.2	28.3	29.7	22.8	10.7	1.5	1.1	9.8	21.9	29.5	27.6
	20	2.4	9.2	18.6	28.3	36.0	40.0	36.4	26.6	14.3	4.2	0.0	3.4	13.1
	25	2.0	7.6	15.9	25.7	35.4	45.0	49.8	48.4	41.3	30.3	17.9	7.3	1.0
	35	1.4	5.6	12.1	20.5	30.0	42.5	54.0	63.0	68.6	69.9	66.8	59.7	49.5
	50	1.0	3.9	8.7	15.2	23.0	34.2	46.5	58.9	70.8	81.4	90.1	96.2	99.5
	75	0.7	2.7	5.9	10.4	16.1	24.6	34.5	45.5	57.4	69.7	82.2	94.5	106.2
	100	0.5	2.0	4.5	7.9	12.2	18.9	26.8	35.9	46.0	56.9	68.5	80.6	92.9
	125	0.4	1.6	3.6	6.3	9.9	15.3	21.8	29.4	37.9	47.3	57.5	68.3	79.7
	150	0.3	1.3	3.0	5.3	8.3	12.8	18.4	24.8	32.1	40.3	49.1	58.7	69.0
	175	0.3	1.1	2.6	4.6	7.1	11.0	15.8	21.4	27.8	34.9	42.8	51.3	60.5
	200	0.2	1.0	2.2	4.0	6.2	9.7	13.9	18.8	24.5	30.8	37.8	45.4	53.7
	225	0.2	0.9	2.0	3.5	5.5	8.6	12.4	16.8	21.9	27.5	33.8	40.7	48.2
	250	0.2	0.8	1.8	3.2	5.0	7.8	11.2	15.2	19.7	24.9	30.6	36.9	43.7
	300	0.2	0.7	1.5	2.7	4.2	6.5	9.3	12.7	16.5	20.9	25.7	31.0	36.7
	350	0.1	0.6	1.3	2.3	3.6	5.6	8.0	10.9	14.2	17.9	22.1	26.7	31.7
	400	0.1	0.5	1.1	2.0	3.1	4.9	7.0	9.5	12.4	15.7	19.4	23.4	27.8
	450	0.1	0.4	1.0	1.8	2.8	4.3	6.2	8.5	11.1	14.0	17.3	20.8	24.8
	500	0.1	0.4	0.9	1.6	2.5	3.9	5.6	7.6	10.0	12.6	15.5	18.8	22.3
	600	0.1	0.3	0.7	1.3	2.1	3.3	4.7	6.4	8.3	10.5	13.0	15.7	18.7
	700	0.1	0.3	0.6	1.1	1.8	2.8	4.0	5.5	7.1	9.0	11.1	13.5	16.0
800	0.1	0.3	0.6	1.0	1.6	2.4	3.5	4.8	6.2	7.9	9.7	11.8	14.0	
900	0.1	0.2	0.5	0.9	1.4	2.2	3.1	4.3	5.6	7.0	8.7	10.5	12.5	
1000	0.1	0.2	0.5	0.8	1.2	2.0	2.8	3.8	5.0	6.3	7.8	9.4	11.2	

13.3.3.3 Sight Distance on Vertical Curves

Sight distance on vertical curves is required so that bicyclists see objects on the path over the crest of vertical curves or obstacles that are located beyond overhanging visual obstructions on sag vertical curves. The method of calculating sight distance for bicyclists on vertical curves is essentially the same as that used for calculating the sight distance for motorists (Refer to Section Chapter 6 of this Guide); however, the user's eye height and object height need to be modified for bicycle-specific values. Stopping sight distance is measured when the eye height and the height of the object are 4.5 feet (for a typical bicycle rider) and 0 feet (flush with the pavement surface), respectively.

When S is less than L ,

$$S = 30 \sqrt{\frac{L}{A}}$$

When S is greater than L ,

$$S = \frac{L}{2} + \frac{2025}{A}$$

Where,

S = stopping sight distance (ft)

L = length of crest vertical curve (ft)

A = algebraic difference in grades (%)

Table 13-7 is used to select the minimum length of vertical curve necessary to provide minimum stopping sight distance at various speeds on crest vertical curves (Figure 13-39). Note that this table is for regular bicycles. For recumbent bicycles, the values would need to be recalculated using equations 3-14 and 3-42 in the 2018 AASHTO GDHS (AASHTO, 2018).

Figure 13-39 Sight Distance on Crest Vertical Curves

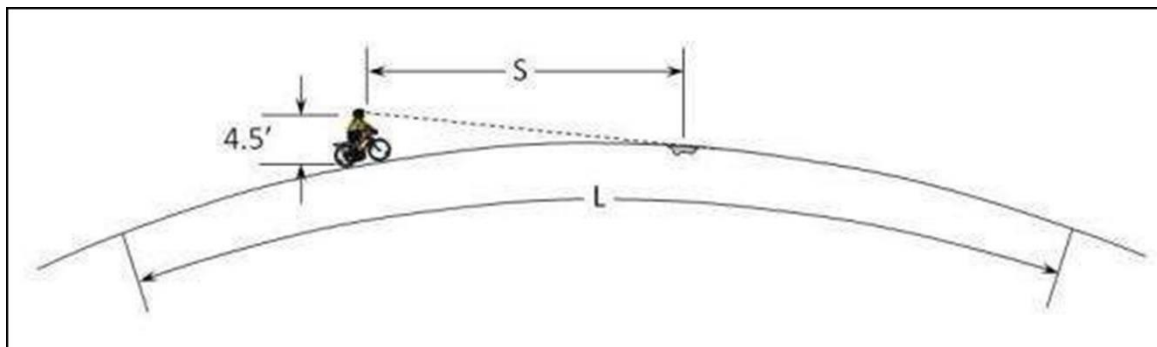



Table 13-7 Minimum Length of Crest Vertical Curve Based on Stopping Sight Distance

A (%)	S = Stopping Sight Distance (ft)														
	20	40	60	80	100	120	140	160	180	200	220	240	260	280	300
2												30	70	110	150
3							20	60		100	140	180	220	260	300
4					15	55	95	135		175	215	256	300	348	400
5				20	60	100	140	180		222	269	320	376	436	500
6			10	50	90	130	171	216		267	323	384	451	523	600
7			31	71	111	152	199	252		311	376	448	526	610	700
8		8	48	88	128	174	228	288		356	430	512	601	697	800
9		20	60	100	144	196	256	324		400	484	576	676	784	900
10		30	70	111	160	218	284	360		444	538	640	751	871	1000
11		38	78	122	176	240	313	396		489	592	704	826	958	1100
12	5	45	85	133	192	261	341	432		533	645	768	901	1045	1200
13	11	51	92	144	208	283	370	468		578	699	832	976	1132	1300
14	16	56	100	156	224	305	398	504		622	753	896	1052	1220	1400
15	20	60	107	167	240	327	427	540		667	807	960	1127	1307	1500
16	24	64	114	178	256	348	455	576		711	860	1024	1202	1394	1600
17	27	68	121	189	272	370	484	612		756	914	1088	1277	1481	1700
18	30	72	128	200	288	392	512	648		800	968	1152	1352	1568	1800
19	33	76	135	211	304	414	540	684		844	1022	1216	1427	1655	1900
20	35	80	142	222	320	436	569	720		889	1076	1280	1502	1742	2000
21	37	84	149	233	336	457	597	756		933	1129	1344	1577	1829	2100
22	39	88	156	244	352	479	626	792		978	1183	1408	1652	1916	2200
23	41	92	164	256	368	501	654	828		1022	1237	1472	1728	2004	2300
24	3	43	96	171	267	384	523	683	864	1067	1291	1536	1803	2091	2400
25	4	44	100	178	278	400	544	711	900	1111	1344	1600	1878	2178	2500

The primary control for designing sag vertical curves for roadways is the limitations of headlamp lighting at night. This control is reasonable for cars because they are required to have operating headlamps, and headlamps are typically adjusted with a reasonable degree of consistency. Bicyclists riding between sunset and sunrise are required to have a headlamp so that the bicyclists are visible to other roadway users (FHWA, 2006). There is a wide variety of headlamp designs, and the light they provide for bicyclists to see the path in front of them is widely variable. Consequently, using headlamp limitations as a design control is not practical for shared-use paths.

A sag curve on a shared-use path must be designed so that it provides the minimum stopping sight distance described for in Section 13.3.3.1. In most cases, meeting these criteria is not problematic. One common exception is when a path is depressed through an undercrossing. In this case, sight distances should be checked to ensure that any overhanging structure does not limit the stopping sight distance to less than what is required.

13.3.3.4 Sight Distance at Intersections

The discussion on intersection sight distance in Chapter 8 of this Guide is also applicable to shared-use paths. Also applicable are the procedures to determine sight distances at intersections

presented in Chapter 8 of the 2018 AASHTO GDHS (AASHTO, 2018), using the appropriate design speed for the shared-use path approaches to the intersection, for each of the cases below:

- Case A - Intersections with no control (not typically used on shared-use paths).
- Case B - Intersections with stop control on the minor road.
- Case B3 - Crossing maneuver from the minor road.
- Case C - Intersections with yield control on the minor road.
- Case C1 - Crossing maneuver from the minor road.
- Case D - Intersections with traffic signal control.

Checking the sight distances for vehicles turning onto or off of the shared-use path is typically not necessary. The minor roadway may be either the shared-use path or the roadway.

13.3.4 Shared-Use Path Width

The minimum width of pavement for a two-directional shared-use path is 10 feet.

Additional width may be appropriate depending on the volume of users and mix of users on the shared-use path. The FHWA has developed a level of service shared-use path calculator that may be helpful in determining the appropriate width for a path based on the relative number of users expected (FHWA, 2006) (MUTCD). Pathways of up to 14 feet are recommended in locations that are anticipated to have high volumes (greater than 300 users in the peak hour), or with a high percentage of pedestrians (greater than 30%). An 11-foot shared-use path allows a bicyclist to pass another traveling in the same direction at the same time someone is approaching from the opposite direction (FHWA, 2006). Wider paths should be considered where there is expected significant use by in-line skaters, hand cyclists, adult tricyclists (FHWA, 2004), or on steep grades and through curves.

A minimum shared-use path width of 8 feet may be used only for short sections of constrained conditions and where the following conditions apply:

- Bicycle traffic is expected to be low, even on peak days or during peak hours
- Pedestrian use of the facility is not expected to be more than occasional
- Horizontal and vertical alignments provide safe and frequent passing opportunities
- The path is not regularly subjected to maintenance vehicle loading conditions that would cause pavement edge damage.

In most cases, it is not necessary to designate separate spaces for different users on shared-use paths. Slower path users tend to keep right while higher speed users pass on the left. If additional encouragement is necessary, PATH USER POSITION (R4-3 or R4-1) signs may be installed to remind users of this required behavior (refer to Figure 13-40) (U.S. Access Board, 2007).

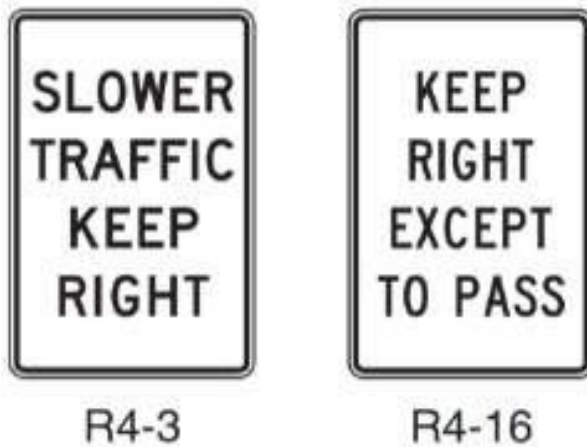
Figure 13-40 Path User Position Signs

In cases where there are high path volumes it may be appropriate to separate directions on the path with a yellow centerline stripe. In areas with adequate sight distance a broken line (3-foot segment with a 9-foot gap) may be provided.

On the approach to conflict points, substandard curves, locations where sight distances cannot be maintained, or other potential hazards, a single solid yellow centerline stripe and an appropriate sign should be installed. The solid stripe should extend a distance at least equal to the stopping sight distance in advance of the conflict point or hazard.

Where users are split onto separate paths, mode specific guide signs should be used to denote the preferred path for each user type (Figure 13-41). SELECTIVE EXCLUSION signs (U.S. Access Board, 2007) can be used to indicate where various users are not permitted (Figure 13-42).

Figure 13-41 Selective Exclusion Signs



Figure 13-42 Mode Specific Guide Signs



13.3.5 Cross Slope

The cross slope of a shared-use path must be designed so that rain and snow melt drain from the pavement surface. Consequently, a minimum cross slope of 1% should be maintained on shared-use paths. Shared-use paths are not typically crowned; a uniform cross slope is maintained across the path.

Because shared-use paths are intended to be used by pedestrians and persons with disabilities, they must comply with the cross slope requirements of the ADA. Therefore, the maximum cross slope for a shared-use path is 2%.

13.3.6 Clearances

Just as minimum clear recovery areas and clear zones to obstructions are provided for roadways, horizontal clearance is required to signs, poles, drop-offs and other path-side obstructions and hazards.

Where practical, a graded shoulder free of obstructions at least 3 feet wide with a maximum cross slope of 6:1 should be maintained on each side of the shared-use path pavement. Under constrained conditions, minimum clear space of 2 feet should be provided to vertical obstructions. If a smooth protective railing is provided, this clearance may be reduced to 1 foot. Where minimum clearance cannot be provided to obstructions, path users should be warned of the upcoming obstruction. Warnings for lateral obstructions can include warning signs, edge line striping, lighting, reflectors, or a combination thereof. When a barrier, railing, or fence is a vertical obstruction, the barrier should be flared so the approach end is at least 3 feet from the edge of the path.

Embankments and sheer drop-offs are particularly hazardous to shared-use path users. If possible, a 5-foot separation should be provided to embankments with slopes greater than 4:1 and drop-offs. Where this separation cannot be maintained, a suitable barrier such as a railing or fence should be provided at the top of the slope. Specifically, barriers should be placed to separate shared-use paths from embankments and drop-offs under the following conditions (refer to Figure 13-43):

- Slopes 3:1 or steeper, with a drop of 6 feet or greater.
- Slopes 2:1 or steeper, with a drop of 4 feet or greater.
- Slopes 1:1 or steeper, with a drop of 1 foot or greater.
- Slopes 3:1 or steeper, adjacent to a parallel water hazard, roadway, or other obvious hazard.

When used, barriers next to a shared-use path shall be a minimum of 42 inches high.



Figure 13-43 Conditions Where Barriers to Embankment are Recommended

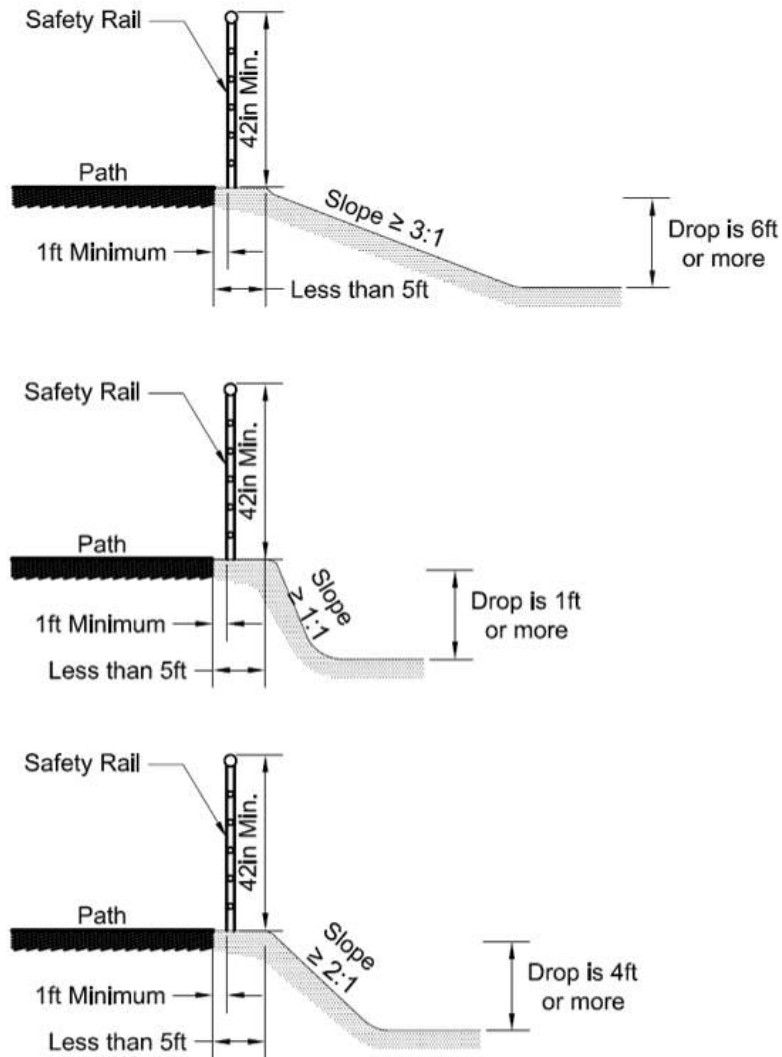

Openings between horizontal or vertical members on railings should be small enough that a 4-inch sphere cannot pass through them in the lower 27 inches. For the portion of railing that is higher than 27 inches, openings may be spaced such that an 8-inch sphere cannot pass through them. This specification is to prevent children from falling through the openings.

Some Colorado jurisdictions require a rub rail at a height where a bicyclist's handlebar may come into contact with a railing or barrier. A rub rail is a smooth surface installed at a height of 36 inches to 48 inches to reduce the likelihood that a bicyclist's handlebars are caught by the railing. Local requirements should be consulted.

The minimum vertical clearance to obstructions is 100 inches, the operating height for a bicyclist.



13.3.7 Horizontal Alignment of Shared-Use Paths

The discussion of horizontal alignment provided in Chapter 6 is also applicable to shared-use paths. Typically, simple horizontal curves should be used on shared-use paths.

Because a shared-use path is also a pedestrian facility, paths must be designed to be compliant with the applicable sections of the ADA. Consequently, the maximum superelevation allowed on a shared-use path is 2%. If separate pathways for pedestrians and bicyclists are provided, the superelevation allowed for the bicycle path may be increased up to 8%.

The minimum radius recommended for shared-use paths is provided in Table 13-8. If the minimum curve radius cannot be met, a centerline stripe and TURN or CURVE WARNING sign (W1 series) shall be installed.

The AASHTO *Guide for the Development of Bicycle Facilities* (AASHTO, 2012) provides an alternative method for calculating minimum radii, which may yield a smaller required radius. It is based upon the lean angle of a bicycle.

Table 13-8 Minimum Radii and Superelevation for Bicycle Only Paths

e (%)	R (feet) for Design Speed (mph)								
	8	10	12	14	16	18	20	25	30
-2.0	14	22	33	47	64	85	109	192	316
-1.5	14	22	33	46	63	83	107	188	308
0.0	13	21	31	44	60	79	101	176	286
1.5	12	20	30	42	57	74	96	165	267
2.0	12	20	29	41	56	73	94	162	261
2.2	12	20	29	41	55	73	93	161	259
2.4	12	19	29	41	55	72	93	160	256
2.6	12	19	29	40	55	72	92	158	254
2.8	12	19	29	40	54	71	91	157	252
3.0	12	19	28	40	54	71	91	156	250
3.2	12	19	28	40	54	70	90	155	248
3.4	12	19	28	40	53	70	89	154	246
3.6	12	19	28	39	53	69	89	153	244
3.8	12	19	28	39	53	69	88	151	242
4.0	12	19	28	39	52	69	88	150	240
4.2	11	19	27	39	52	68	87	149	238
4.4	11	18	27	38	52	68	87	148	236
4.6	11	18	27	38	51	67	86	147	234
4.8	11	18	27	38	51	67	85	146	233
5.0	11	18	27	38	51	66	85	145	231
5.2	11	18	27	37	51	66	84	144	229
5.4	11	18	27	37	50	66	84	143	227
5.6	11	18	26	37	50	65	83	142	226
5.8	11	18	26	37	50	65	83	141	224
6.0	11	18	26	37	49	64	82	140	222
f = Friction Factor	0.33	0.32	0.31	0.30	0.29	0.28	0.26	0.24	0.21

13.3.8 Vertical Alignment of Shared-Use Paths

Where technically feasible, the maximum continuous grade on a shared-use path should be limited to 5%. Where right of way, topography, or geometric constraints make the provision of a continuous grade less than 5% impractical, grades should be minimized.

Where potential grades exceed 5%, intermittent level resting intervals should be considered. Where provided, resting intervals shall be full width of the shared-use path and 60 inches long. Alternatively, a 36-inch-wide resting interval may be located adjacent to the shared-use path. Recommended maximum distance between resting areas is 200 feet.

Shared-use paths located along roadways may follow the grade of the road. Where grades exceed 5%, resting intervals should be provided.

Where sustained grades exceeding 4% in excess of 300 feet in length are required, an increased design speed should be used. Additionally, consider providing the following mitigating measures:

- HILL WARNING signs (W7-5) (Figure 13-44).
- Wider clear recovery areas adjacent to the shared-use path
- An additional 6 feet of width to allow some users to dismount and walk their bicycles.

Figure 13-44 Bicycle Hill Warning Sign



Alternatively, consider installing a series of switchbacks to reduce the longitudinal grade.

Except for ramps on structures, transitions between grades with more than 2% algebraic difference should be made with vertical curves. The minimum length for a vertical curve on a shared-use path is 3 feet.

On unpaved shared-use paths, grades greater than 3% are not recommended. Grades exceeding 3% can create maintenance (erosion) problems and cause bicycle handling problems for some bicyclists.

In flat terrain, the grade of the shared-use path may be controlled by drainage considerations.

13.3.9 Intersections with Shared-Use Paths

The background information provided in Chapter 8 of this Guide is applicable to intersections of shared-use paths with roadways or other shared-use paths.

The fundamental design of intersections requires that users be able to:

- Perceive the intersection and the potential conflicts
- Understand their obligations to yield
- Fulfill the obligation to yield

The design criteria in this section are intended to support these three fundamental concepts.

When designing shared-use path intersections, the sight distance criteria provided in Section 13.3.3.4 and Chapter 8 of this Guide are applicable. Only the design speeds of the intersecting approach legs - using the bicycle as a design vehicle for pathway approaches - are adjusted when applying these criteria to shared-use paths.

At shared-use path intersections with roadways or with other shared-use paths, one facility should be given priority over the other. Four-way stop control should not be used at intersections of shared-use paths.

According to the MUTCD,

When placement of STOP or YIELD signs is considered, priority at a shared-use path/roadway intersection should be assigned with consideration of the following:

- A. Relative speeds of shared-use path and roadway users;*
- B. Relative volumes of shared-use path and roadway traffic; and*
- C. Relative importance of shared-use path and roadway.*

Speed should not be the sole factor used to determine priority, as it is sometimes appropriate to give priority to a high-volume shared-use path crossing a low-volume street, or to a regional shared-use path crossing a minor collector street.

When priority is assigned, the least restrictive control that is appropriate should be placed on the lower priority approaches. STOP signs should not be used where YIELD signs would be acceptable.

The primary consideration in the assignment of traffic control type (STOP rather than YIELD signs) at intersections is the availability of adequate sight distance for approaching users. If sight triangles cannot be maintained to provide for yield control, STOP signs must be used. A detailed discussion of sight triangles is provided in Section 13.3.9.1.

Where a shared-use path crosses a roadway, detectable warnings shall be installed. Where two shared-use paths intersect, the approach that is required to yield the right of way should have detectable warnings installed.

Roundabouts can be used at the intersection of two shared-use paths. A minimum width of 8 feet should be maintained around the circulating pathway. Splitter islands and central islands on roundabouts for shared-use paths should be curbed.

Traffic control for shared-use path approaches to intersections is provided in Section 13.3.9.2.

Intersections of shared-use paths with roadways should be located outside of the functional area of the intersection of two roadways (Figure 13-45). If a shared-use path crosses a roadway within the functional area of an intersection, the path should either be diverted to outside the functional area of the intersection or moved to the intersection and treated as a side path crossing (refer to Section 13.3.13.1).

Figure 13-45 Functional Area of an Intersection

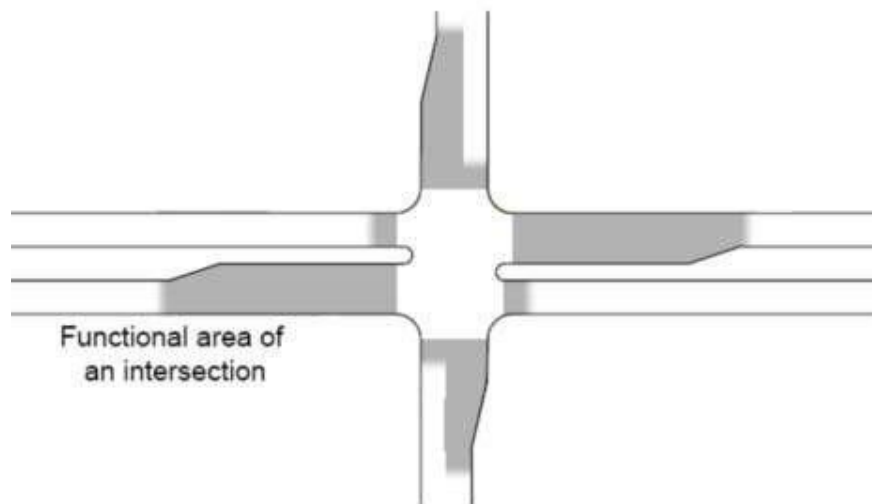

Traffic signals can be warranted where shared-use paths cross roadways, based on any of the nine warrants described in the MUTCD. For the School Crossing and Pedestrian Volume warrants, all path users may be counted as pedestrians. For the Eight-Hour Vehicular Volume, Four-Hour Vehicular Volume, and Peak Hour warrants, only bicycles are counted as vehicles on the path approaches.

Where signals are installed for shared-use paths, signal timing shall accommodate the needs of bicyclists and pedestrians.

13.3.9.1 Required Sight Triangles at Shared-Use Path Intersections

The decision to use a STOP sign as opposed to a YIELD sign is primarily determined by the available sight distance required for bicyclists at the intersection.

The procedures to determine sight distances at intersections presented in Chapter 9 of the 2018 AASHTO GDHS (AASHTO, 2018) apply to bicycle facilities and roadways. In this section, the requirements for each of the following cases is discussed for both stop and yield control:

- Case B3 - Stop Controlled crossing maneuver from the minor road.
- Case C1 - Yield Controlled crossing maneuver from the minor road.

For Case B3 where the path is under stop control, the required sight distance at the intersection is a function of the time it takes the slowest design user to cross the street or cross to a refuge island in the middle of a divided roadway. In most cases the slowest design user is the pedestrian.

However, since shared-use path crossings of roadways are almost always marked with crosswalks, the sight distance must allow for a motorist to observe and yield to a pedestrian approaching and crossing at the shared-use path-roadway intersection. To calculate the required sight triangle, it should be assumed the pedestrian is standing behind the shared-use path yield or stop line.

For Case B3 where the road is under stop control, the sight distance should be calculated as provided in the 2018 AASHTO GDHS (AASHTO, 2018) using the shared-use path design speed as the speed on the major road. By applying equation 9-1 from the 2018 AASHTO GDHS:

$$ISD = 1.47V_{path}t_g$$

Where,

ISD = intersection sight distance (ft)

V_{path} = design speed of path (mph)

t_g = time gap for minor road vehicle to enter and cross path (sec)

The 2018 AASHTO GDHS provides a time gap (t_g) of 6.5 seconds for passenger cars, 8.5 seconds for single-unit trucks, and 10.5 seconds for a combination truck to cross a two-lane roadway based upon observational studies. Consequently, they are conservative for crossing of most shared-use paths. However, on multilane roadways where advance STOP or YIELD lines are used, additional time should be allowed, as follows: 1.3 seconds additional for a 30-foot advance line and 1.8 seconds for a 50-foot advance line for passenger cars (2.1 seconds and 2.9 seconds for trucks, respectively).

Additionally, where approach grades exceed 3%, add 0.1 second for each percent grade.

The clear sight triangle is that space that should be kept free of obstructions that might block approaching driver's view of any potentially conflicting path users. Figure 13-46 illustrates the needed dimensions for calculating the sight triangle for Case B3 where motorists are required to stop. Table 13-9 provides the values for those dimensions.



Figure 13-46 Illustration of Intersection Sight Triangle Dimensions

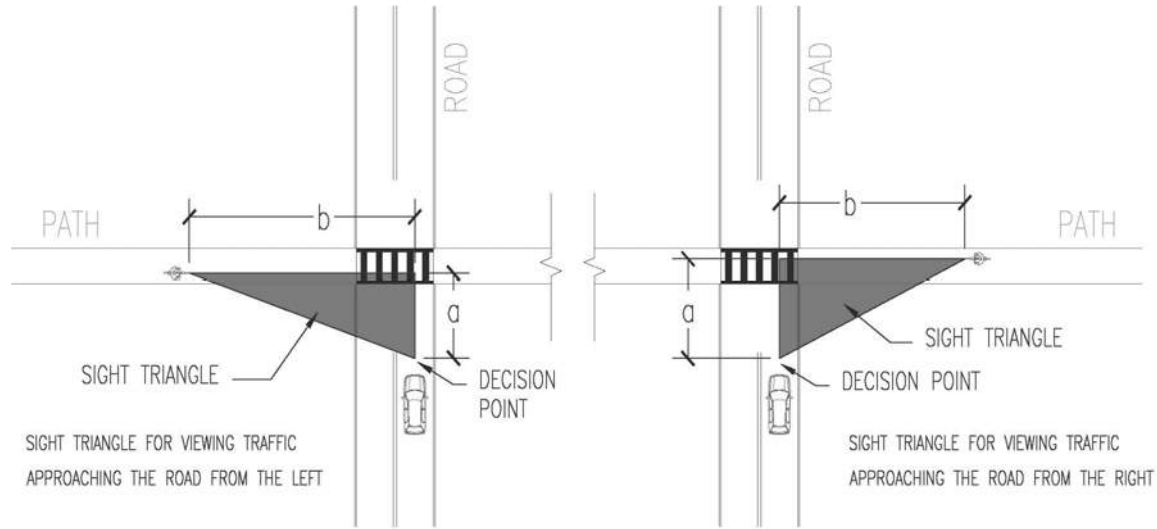

Case B3, Motorist Required to Stop

- a = assumed distance to driver's eye
- b = intersection sight distance

Table 13-9 Intersection Sight Distance

--	Intersection Sight Distance for Passenger Cars (distance b)		
--	Distance to Stop Bar		
Design Speed of Path (mph)	4 feet	30 feet	50 feet
8	80	95	100
10	100	115	125
12	115	140	150
14	135	165	175
16	155	185	200
18	175	210	220
20	195	230	245
25	240	290	310
30	290	345	370
Assumed distance to driver's eye (distance a)	14.5 feet	40.5 feet	50.5 feet

For Case C3 where the path is under yield control, sight triangles are calculated assuming that the yielding approaches will decelerate to 60% of the design speed on the approach to the intersection and that the approaches with priority will not decelerate. Sight distances are calculated based upon the time taken for the vehicle on the minor road to cross the intersection. The travel time to



reach and clear the major road from the decision point on the minor approach is calculated using the following equations:

$$t_g = t_a + \frac{w + L_a}{0.88V_{minor}}$$

Where,

$$t_a = \frac{1.47(V_{minor} - V_r)}{a_m}$$

and

- t_g = time gap for minor road vehicle to reach and clear the major road (sec)
- t_a = travel time for minor road vehicle to reach the major road while decelerating (sec)
- w = width of intersection to be crossed (ft)
- L_a = length of design vehicle (ft)
- V_{minor} = design speed of minor facility (mph)
- V_r = reduced speed of minor approach (60% design speed)(mph)
- a_m = acceleration rate assumed for minor approach (assume 5 ft/sec/sec)

The length of the sight triangle along the major approach is calculated using the equation:

$$b = 1.47V_{major}t_g$$

where,

- b = sight distance required along major approach (ft)
- V_{major} = design speed of major facility (mph)

The sight distance required along the minor approach (a) can be obtained from Table 13-10.

Table 13-10 Required Sight Distance for Minor Leg of Yield Control

Design Speed of Minor Leg (mph)	Sight Distance (ft)
12	62
14	71
16	80
18	90
20	100
25	130
30	160
35	195
40	235
45	275
50	320
55	370

Figure 13-47 illustrates the dimensions for yield control intersections. Users are not shown on the graphic because either approach (major or minor) could be the shared-use path.

Figure 13-47 Illustration of Intersection Sight Triangle Dimensions Case C3, Yield Condition

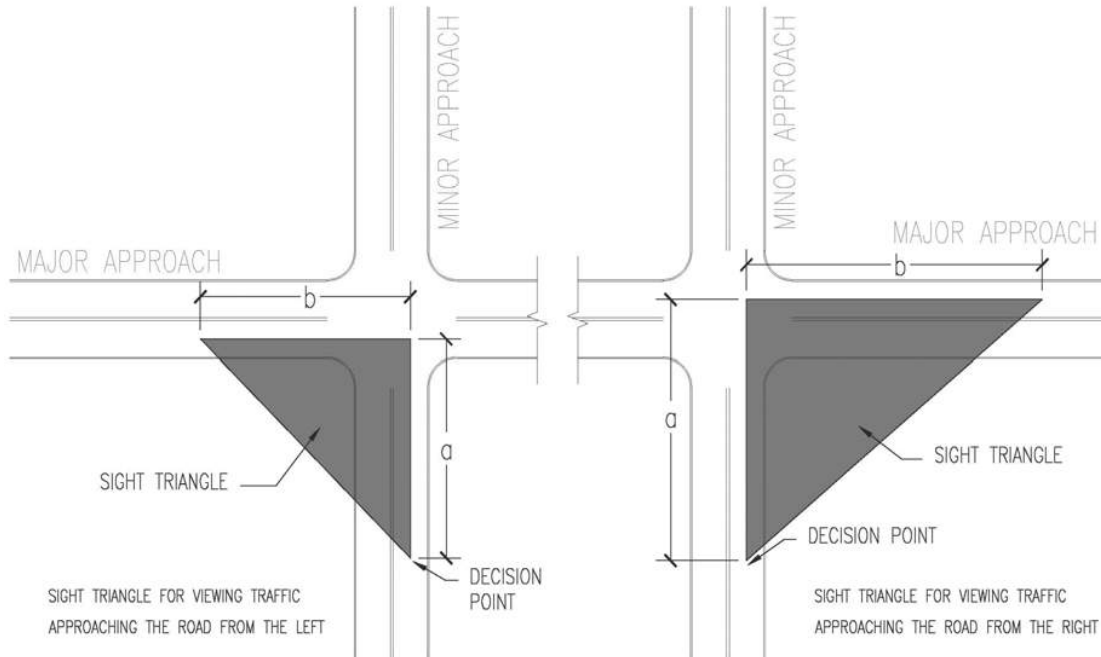

Where a shared-use path approaches a walkway and is required to stop, the legs of the sight triangle should extend 25 feet back from the edge of the sidewalk along the shared-use path, and 15 feet back from the edge of the shared-use path along the sidewalk (Figure 13-48).

Figure 13-48 Illustration of Intersection Sight Triangle Dimensions Path Approaching Sidewalk

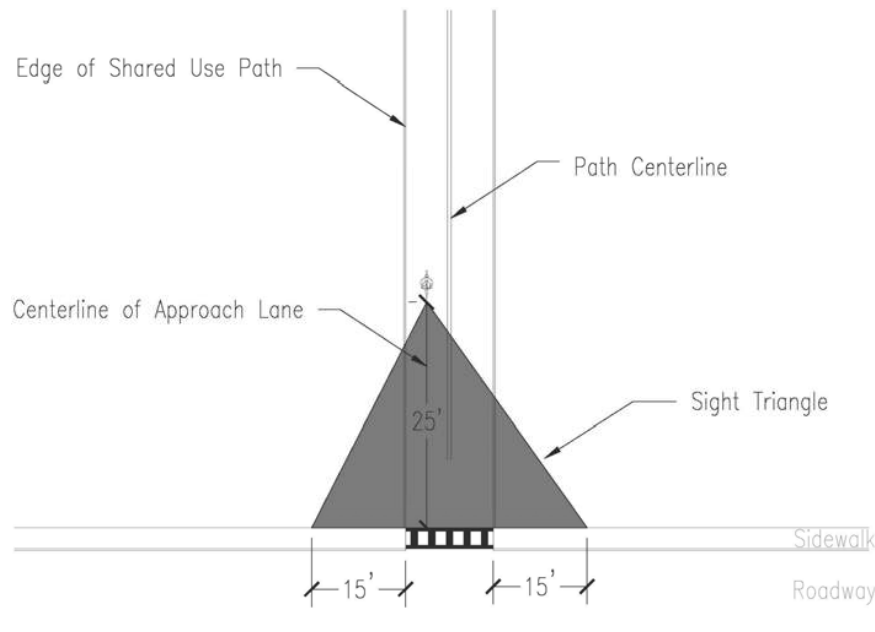

13.3.9.2 Traffic Control at Intersections with Shared-Use Paths

The traffic control provided on shared-use paths at intersections with other paths or roadways is similar to that provided at the intersection of two roadways.

STREET NAME signs (D1-3) should be included for shared-use path users.

On the approach to any intersection, a solid yellow centerline should be striped on the approach to the intersection for a distance equal to the stopping sight distance of the shared-use path.

An INTERSECTION WARNING (W2 series) or ADVANCE TRAFFIC CONTROL (W3 series) sign may be used on a roadway, street, or shared-use path in advance of an intersection to indicate the presence of an intersection and the possibility of turning or entering traffic. However, these signs are not required unless the engineering judgment determines that the visibility of the intersection is limited on the shared-use path approach to the intersection. When deciding whether to install advance signs, the designer should ensure that intersections and intersection traffic control are visible from at least the stopping sight distance in advance of the intersection. Figure 13-49 shows W2 and W3 series signs.

Figure 13-49 Intersection Warning (W2 Series) and Advance Warning Signs (W3 Series) Signs



Where the shared-use path user is to yield or stop (with either a STOP sign or a signal) at the intersection, YIELD signs and YIELD lines or STOP signs and STOP lines shall be installed on the path approach to the intersection. YIELD or STOP lines shall be placed 4 feet in advance of the intersecting travel way or sidewalk.

For signal control intersections, bicycle detection and push buttons for pedestrians should be installed on the path approaches.

On the motor vehicle approach, signing and striping vary depending on which facility is given priority at the intersection. If the path is given priority at the intersection, then the roadway

approaches should be signed and marked as they would be on the approach to any intersection with similar control (YIELD, STOP, or signal control). If the roadway is given priority at the intersection, traffic control appropriate for a midblock crossing must be installed (refer to Section 13.4.8 and Section 13.4.9). At trail crossings, the TRAIL CROSSING (W11-15 and W11-15p) sign assembly (Figure 13-50) should be used instead of the PEDESTRIAN CROSSING sign (W11-2).

Figure 13-50 Trail Crossing Assembly



At any activated crossing (e.g., a hybrid beacon), if the bicyclist is required to cross the roadway in stages, additional activation mechanisms (e.g., loops, video detection, radar, push buttons) must be placed in the median. Signing should be provided to make bicyclists aware of any requirement on their part to activate multiple crossings

13.3.9.3 Reducing Speeds on the Approach to Intersections

As stated in Section 13.2.8, users of intersections must be able to perceive a conflict, understand their obligation, and be able to fulfill their obligation to yield or stop. Slowing drivers and path users down on the approach to intersections can provide more time for users to perceive and understand their obligations.

Horizontal deflection on the approach to an intersection, either through a series of low design speed curves or a chicane (i.e., horizontal curvature), can be incorporated to reduce bicycle speeds. Examples of these geometric design techniques are provided in Figure 13-51 and Figure 13-52. Care should be taken to end chicanes at least 30 feet from bollards or intersecting sidewalks or roadways to allow the user to dedicate their attention to navigating the curves in the shared-use path first, followed by the approaching intersection (rather than simultaneously).



Figure 13-51 Chicane on Approach to Intersection

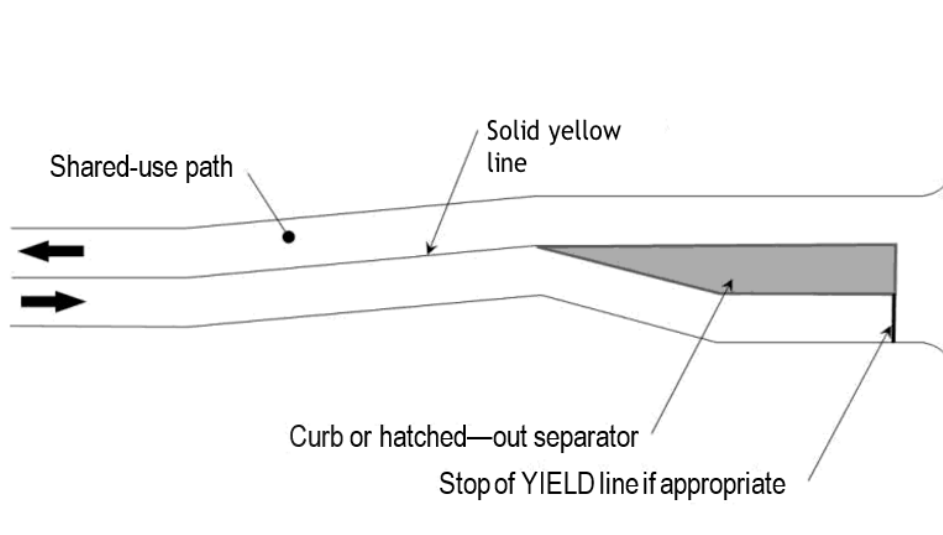
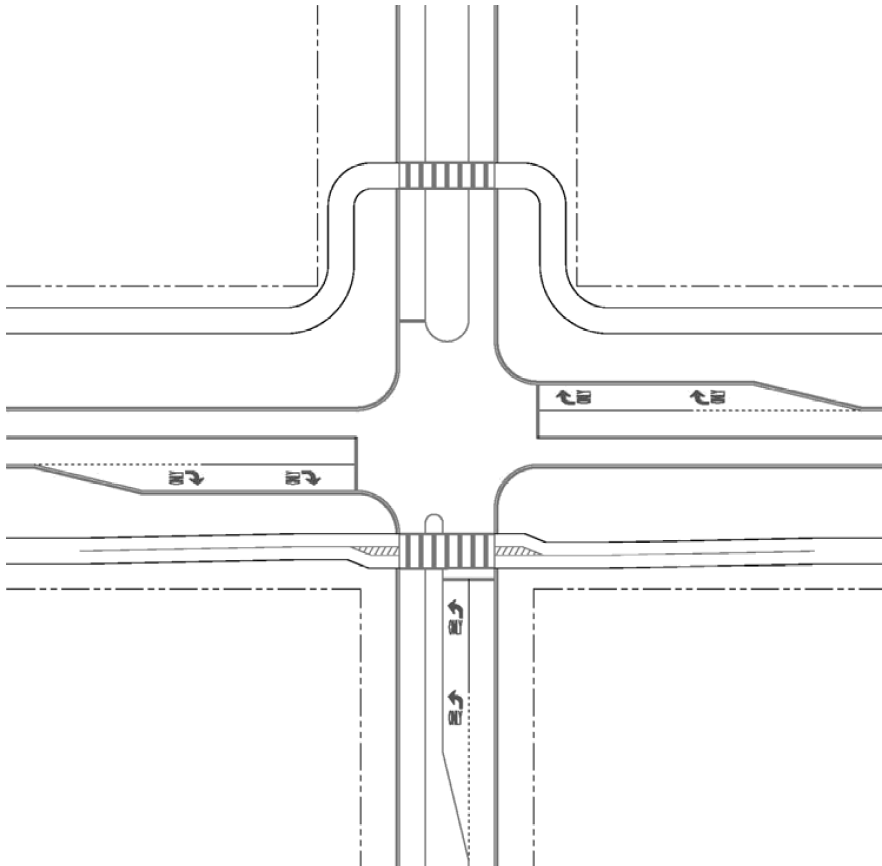

Figure 13-52 Geometric Design to Slow Bicyclists on Intersection Approaches



13.3.9.4 Curb Ramps

Where a shared-use path crosses a roadway, it is considered a pedestrian crossing location, and ADA-compliant curb ramps (if curbs are present) shall be installed. The width of the ramp, not inclusive of the flares or curb returns, must be the full width of the approach path. Refer to Section 13.3.9.4.

Detectable warnings shall be placed at the base of the curb ramps across the entire width of the ramps or across the entire width of the path on the approach to crossings where no curbs are present.

13.3.9.5 Prevention of Motor Vehicle Encroachment onto Shared-Use Paths

On some shared-use paths, encroachment by motor vehicles may be a concern. If the primary cause of encroachment is a lack of understanding on the part of the motorists of the non-motorized nature of the facility, consider the installation of NO MOTOR VEHICLES (R5-3) signs at the shared-use path access points (Figure 13-53).

Figure 13-53 No Motor Vehicles Sign (R5-3)



Physical barriers can limit motor vehicle access to a shared-use path, but they are often ineffective in prohibiting access to motor vehicles. Motorists, and more frequently all-terrain vehicles, often go around or damage barriers intended to limit motor vehicle access. Barriers can, however, present obstructions to shared-use path users. Consequently, their use should be limited.

One method of discouraging access to motorists is the use of a low, central, dividing island on the shared-use path approach to intersections. Combined with tight curb radii, this method can be quite effective. The island should be designed so that emergency and maintenance vehicles can access the path by straddling the island. The width of the path on either side of the island should be at least 6 feet wide; in constrained conditions, the path may be narrowed to 5 feet wide on either side of the dividing island. Where divisional islands are provided, solid yellow lines are to be provided in advance of and on either side of the island.

Tight curb radii, such as 2 feet, at path-roadway intersections can reinforce the non-motorized nature of shared-use paths (Figure 13-54).

Figure 13-54 Example of Schematic Path Entry

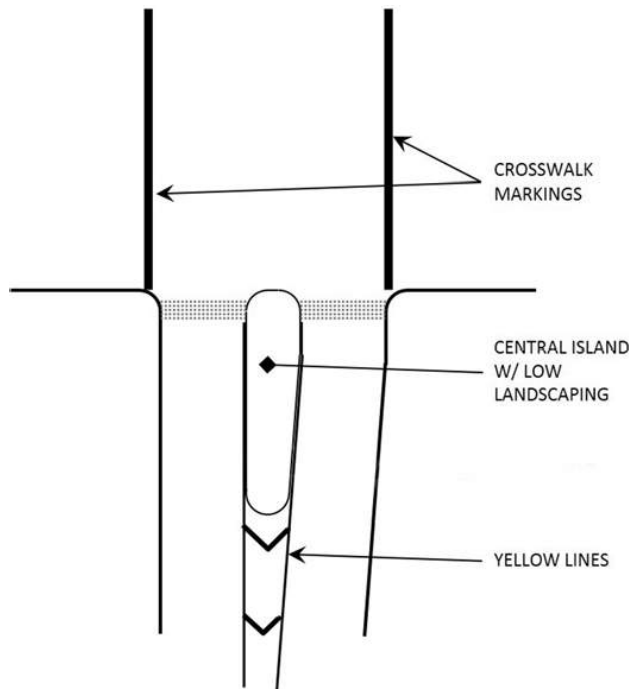

If bollards are used to restrict motor vehicle access at intersections of roadways with paths, a 6-foot clear space should be provided between bollards. If more than one bollard is used, then an odd number of bollards should be used so that one bollard is in the center of the path. Obstruction striping shall be installed around the bollards. Around the *central* bollard, the obstruction striping shall be yellow to denote opposite directions of travel on either side of the bollard. Additional bollards shall have white obstruction markings (Figure 13-55). Solid lines on the approach to the bollard should extend a distance equal to the stopping sight distance in advance of the bollards.

Directional arrows may be placed on the approach to the paths between the bollards to prevent confusion of path users. Where used, bollards shall be marked with retroreflective material on both sides or with the appropriate object marker, as shown in the MUTCD. In addition, bollards should be:

- Visible from a distance equal to or greater than the stopping sight distance.
- At least 40 inches high.
- Have a minimum diameter of 4 inches.
- Be set back 30 feet from the through lanes on the adjacent roadway.

If used, bollards shall be placed where motorized vehicles cannot easily bypass them.

Bollards should be installed so that they can be removed by emergency or maintenance personnel. Any hardware used to secure the bollard should be flush with the surface of the bollard or ground so as not to create an additional obstruction.



Figure 13-55 Obstruction Striping Around Bollards on Shared-Use Paths

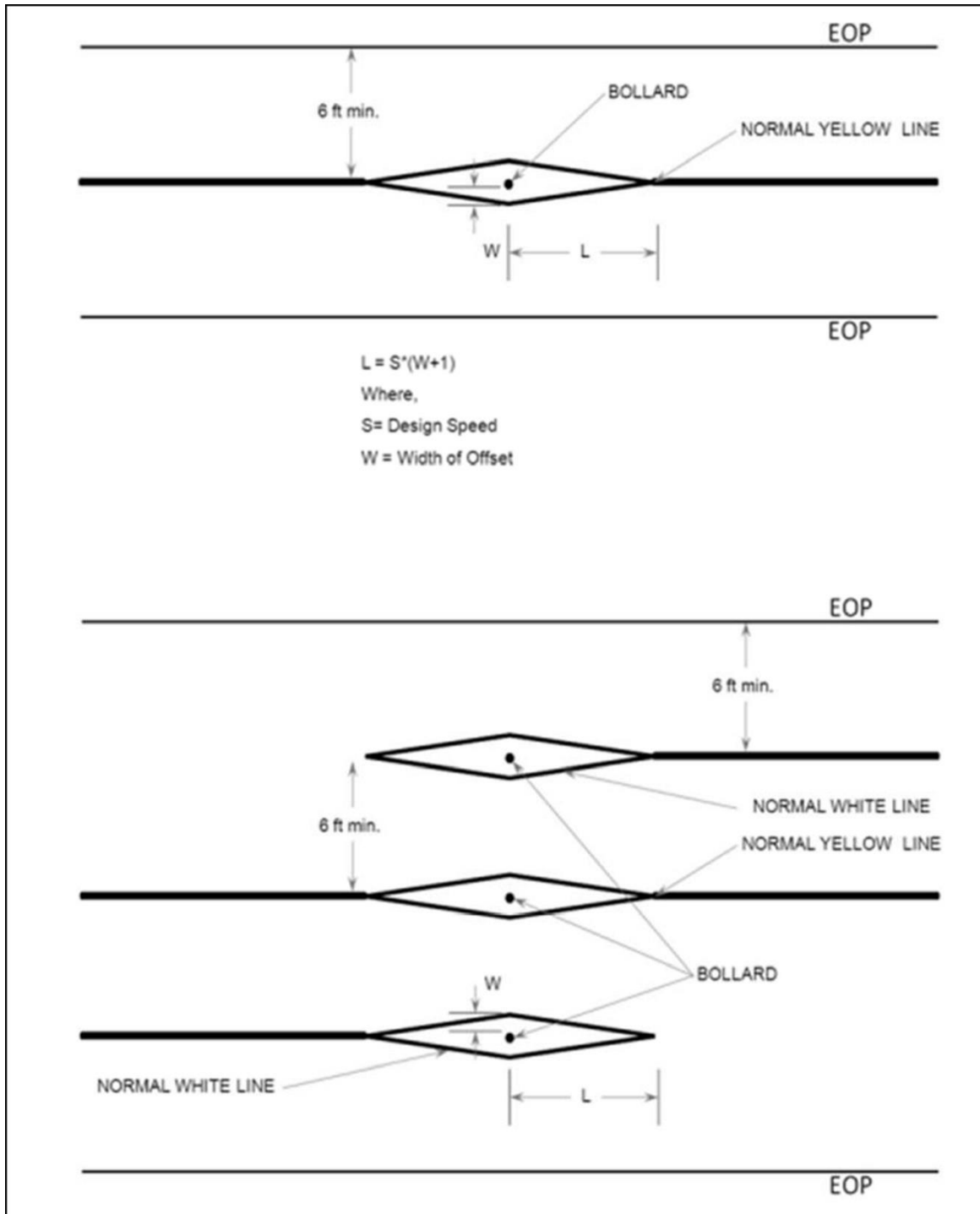

13.3.10 Underpass and Overpass Structures

To maintain the continuity of a shared-use path, some structures may be required. When deciding between a tunnel and an overpass, the characteristics of each crossing should be considered before determining which structure is most appropriate. Each structure type has benefits and drawbacks that need to be considered for each individual location. Constraints such as right of way, topography, and utility conflicts may dictate whether an overpass or underpass is more appropriate.

Overpasses generally provide good visibility of surrounding areas which may lead to a greater sense of security, they are well lit during daylight hours, and they more easily accommodate drainage. Conversely, overpasses typically require a greater elevation change and may be more difficult for users to traverse, they are exposed to the elements, and speeds on the downward approaches can be hazardous.

Underpasses often exhibit contrasting characteristics to overpasses. They are protected from the elements and often require less ramping or changes in elevation, typically making them easier to traverse. Underpasses can have drainage challenges, utility conflicts, and may require construction phasing. Underpass design and layout should also consider user safety. Limited visibility through a closed structure may have a negative impact on user's perception of personal safety. When an underpass is long, wider openings, additional width, or flared ends may be appropriate to improve natural lighting and visibility. Lighting may also be required within the underpass. Approaches and grades should be evaluated to provide the maximum possible field of vision towards the underpass.

13.3.10.1 Width and Clearance for Structures Serving Shared-Use Paths

All bridges and tunnels serving shared-use paths should carry the width of the approach path and the minimum clear space of 2 feet on each side of the path across the structure. Carrying the clear space across the structure provides maneuvering space for bicyclists to avoid pedestrians or stopped bicyclists, as well as necessary horizontal shy distance from railing, walls, or barriers.

If the full path width and clear space cannot be carried across a structure, railings with proper flared ends should be provided to reduce the path width on approaches (refer to Section 13.2.6).

Access by emergency or maintenance vehicles should be considered when establishing the clearances of structures serving shared-use paths. Motor vehicles authorized to use the path may dictate the vertical and horizontal clearances.

A vertical clearance of 10 feet is desirable for enclosed structures and tunnels. If access for motor vehicles is not required, the minimum vertical clearance should be 8 feet under constrained conditions. Designers may want to consider providing 8.3 feet (100 inches), which is the operating height of a bicyclist, when on a shared-use path (AASHTO, 2012).



13.3.10.2 Grades on Structures Serving Shared-Use Paths

All structures serving shared-use paths must be ADA compliant. Cross slopes shall not exceed 2%. If approach grades exceed 5%, they shall be designed as ramps. Resting intervals measuring 60 inches in the direction of travel along the path and full width of the structure shall be provided a maximum of every 30 inches of rise. Refer to Figure 13-56.

Figure 13-56 Maximum Spacing of Resting Intervals on Shared-Use Path Structure Ramps

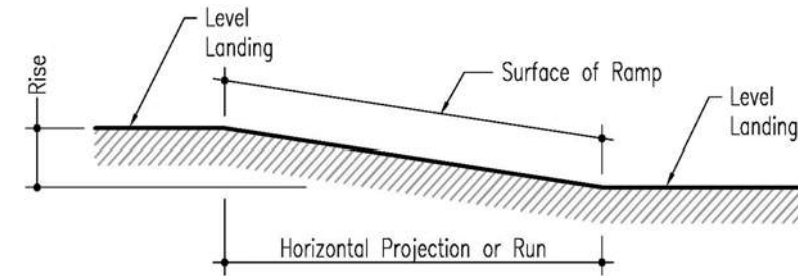

Slope	% Grade	Maximum	
		Rise	Horizontal Projection
		In.	Ft.
1:12 to > 1:16	8.33% to > 6.25%	30	30
1:16 to > 1:20	6.25% to > 5.00%	30	40

Components of a Single Ramp Run and Sample Ramp Dimensions

13.3.10.3 Railings on Structures Serving Shared-Use Paths

Railings on shared-use path structures shall be designed to comply with Section 13.3.6.

13.3.10.4 Railroad Crossings

Where possible, shared-use paths should be aligned to cross railroad tracks at near right angles. Where this cannot be accomplished and the crossing angle is less than 45 degrees, SKEWED CROSSING signs (W10-12) shall be placed on the path approaches to the rail crossing.

A railroad-path crossing, like a railroad-highway crossing, requires at-grade or grade-separated crossings. The horizontal and vertical geometrics of a path approaching an at-grade railroad crossing should be constructed in a manner that does not divert a path user's attention from path surface conditions.

The same types of crossing treatments used for roadway crossings of railroads can be used on shared-use paths, ranging from the required CROSSBUCK sign (R15-1) to full signals and gates.

Where active traffic control devices are not used, a CROSSBUCK ASSEMBLY shall be installed on each approach to a pathway grade crossing. The CROSSBUCK ASSEMBLY may be omitted at station crossings and on the approaches to a pathway grade crossing that are located within 25 feet of the

traveled way of a highway-rail or highway-light-rail-transit grade crossing. Pathway grade crossing traffic control devices should be located a minimum of 12 feet from the center of the nearest track. If used at a pathway grade crossing, an active traffic control system shall include flashing-light beacons for each direction of the pathway. A bell or other audible warning device shall also be provided.

Advance pavement markings and signs shall be used on the approach to railroad crossings (Figure 13-57). The minimum sizes of pathway grade crossing signs shall be as shown in the shared-use path column in Table 9B-1 of the MUTCD.

If used, swing gates should open away from the tracks so that pathway users can quickly push the gate open when moving away from the tracks. If used, swing gates should automatically return to the closed position after each use.

To meet the requirements of Proposed Guidelines for Pedestrian Facilities in the Public Right-of-Way (PROWAG), path surfaces shall be flush with the tops of rails (U.S. Access Board, 2011). Openings for wheel flanges at path crossings of freight rail track shall be 3 inches maximum. Openings for wheel flanges at path crossings of non-freight rail track shall be 2.5 inches maximum.

It is recommended to coordinate early and often with the railroad owner to determine the appropriate and required design elements.

Figure 13-57 Example Signage and Markings at a Shared-Use Path Crossing of Railroad

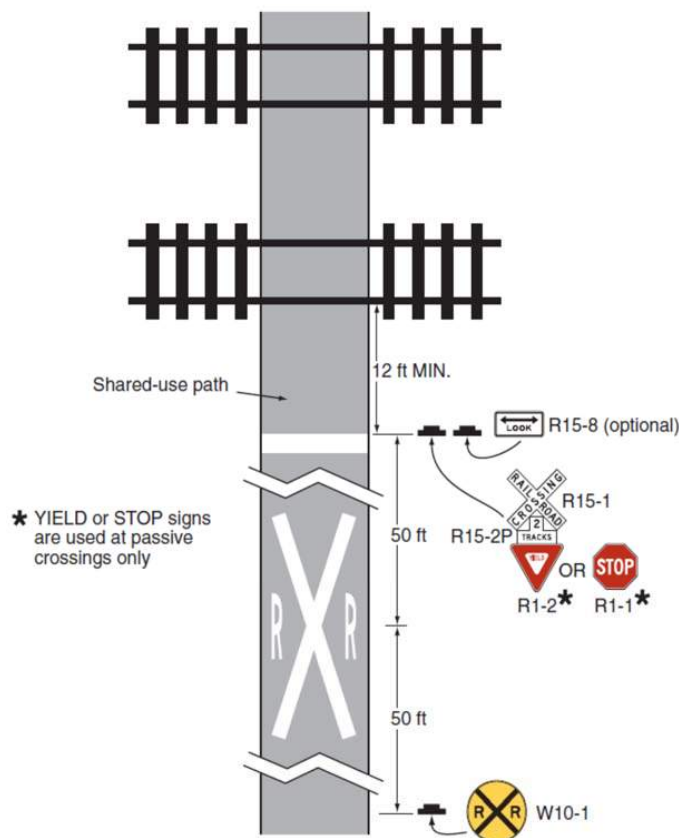

13.3.10.5 Utilities

As discussed in Section 13.2.13.2, drainage structures and utility lids should not be placed in shared-use path. Where it is unavoidable, drainage grates should be of a bicycle friendly design, and utility covers should be flush with the surface of the path (refer to Section 13.2.13.2 for examples of bicycle-friendly grates).

Utilities that are higher than ground level, such as backflow preventers or valves, should be treated as vertical obstructions and addressed as discussed in Section 13.3.6.

13.3.10.6 Traffic Calming on Shared-Use Paths

In areas with frequent crossing conflicts with motor vehicles, it may be desirable to limit the path user's speed (refer to Section 13.3.2). Design features are recommended to reduce speeds on shared-use paths.

Signing is not an effective method for reducing speeds for two reasons: bicyclists, like motorists, operate at a speed they feel comfortable with on a facility, and most bicyclists do not have speedometers installed on their bicycle. Vertical traffic calming treatments (speed humps, tables, or pillows) are not recommended on shared-use paths because they are a safety hazard for bicyclists.

Horizontal alignment is the recommended method for reducing speeds on shared-use paths. A series of low design speed curves or a chicane along a path, much like those described in Section 13.3.9.3 can be used to reduce speeds at non-intersection areas. Advance striping and signage should supplement the trail calming features— either appropriate CURVE WARNING signs or a general text sign indicating that path is a reduced speed zone.

13.3.11 Wayfinding on Shared-Use Paths

The bicycle wayfinding signs described in Section 13.2.4 may be used on shared-use paths.

Additional wayfinding signing on shared-use paths is often appropriate. On independent alignment paths, information such as the distance between trail heads, or to the next water fountain or restroom facilities are important to path users. Much as Motorists Service signs provide expressway users information on what amenities are available at interchanges, signs may be appropriate to inform path users of the proximity of dining establishments, bike shops, or other destinations of particular interest to path users.

13.3.12 Shared-Use Paths Adjacent to the Roadway (Sidepaths)

The term sidepath refers to a shared-use path located immediately adjacent and parallel to a roadway. All design criteria associated with shared-use paths apply to sidepaths.

Ideally, shared-use paths are constructed in their own rights-of-way. However, in some cases a shared-use path may be designed adjacent to a roadway. Such cases might include:

- Where the public desires a low-stress facility to ride on adjacent to a busy or high-speed roadway
- As a temporary facility where a roadway cannot be modified to include bike facilities
- As a connecting facility along a longer shared-use path.

It is likely the last condition will be the one that most designers are requested to address. As discussed in Section 13.3.13, the perception of a sidepath as a low-stress facility does not necessarily equate to it being a safer facility. For reasons of safety or convenience, a sidepath may not be used by more traffic savvy bicyclists. A sidepath should not be considered a permanent alternative to an on-street facility; rather it should be considered as temporary or a supplemental facility to serve a specific design user type.

13.3.13 Safety Considerations of Sidepaths

Locating a sidepath immediately adjacent to a roadway can create operation concerns. The *AASHTO Guide for the Development of Bicycle Facilities (2012)* summarizes many of the problems that may occur in Section 5.2.2. The more prevalent concerns are:

- Unless separated, they require one direction of bicycle traffic to ride against motor vehicle traffic, contrary to normal rules of the road.
- When the path ends, bicyclists going against traffic tend to continue to travel on the wrong side of the street. Likewise, bicyclists approaching a shared-use path often travel on the wrong side of the street in getting to the path. Wrong-way travel by bicyclists is a major cause of bicycle/automobile crashes and should be discouraged at every opportunity.
- At intersections, motorists entering or crossing the roadway often do not notice bicyclists approaching from their right, as they are not expecting contra-flow vehicles. Motorists turning to exit the roadway may likewise fail to notice the bicyclist. Even bicyclists coming from the left often go unnoticed, especially when sight distances are limited.
- Signs posted for roadway users are backwards for contra-flow bike traffic; therefore, these cyclists are unable to read the information without stopping and turning around.
- When the available right of way is too narrow to accommodate all highway and shared-use path features, it may be prudent to consider a reduction of the existing or proposed widths of the various highway (and bikeway) cross sectional elements (e.g., lane and shoulder widths, etc.). However, any reduction to less than 2018 AASHTO GDHS criteria (or other applicable) design criteria must be supported by a documented engineering analysis.
- Many bicyclists use the roadway instead of the shared-use path because they have found the roadway to be more convenient, better maintained, or safer. Bicyclists using the roadway may be harassed by some motorists who feel that in all cases bicyclists should be on the adjacent path.
- Although the shared-use path should be given the same priority through intersections as the parallel highway, motorists falsely expect bicyclists to stop or yield at all cross streets and

driveways. Efforts to require or encourage bicyclists to yield or stop at each cross street and driveway are inappropriate and frequently ignored by bicyclists.

- Stopped cross street motor vehicle traffic or vehicles exiting side streets or driveways may block the path crossing.
- Because of the proximity of motor vehicle traffic to opposing bicycle traffic, barriers are often necessary to keep motor vehicles out of shared-use paths and bicyclists out of traffic lanes. These barriers can represent an obstruction to bicyclists and motorists.

Additional potential operational and design problems associated with sidepaths include the following:

- Because utilities are often located in the right of way, it can be difficult to meet clearance and radii requirements within the available space.
- In addition to traveling in a direction not expected by motorists exiting driveways or side streets, bicyclists riding on sidepaths are also traveling at speeds significantly greater than those of pedestrians. This makes them less likely to be seen by motorists exiting the side street who may be looking immediately to their right for pedestrians.
- If a sidepath is created in a location where there would otherwise be a sidewalk (i.e., a residential neighborhood or an urban commercial district), higher volumes of pedestrians are likely and thus conflicts with pedestrians are likely to increase. While this concern could be mitigated by widening the path, this may increase bicyclists' speeds in off-peak periods, exacerbating the problem of higher speed cyclists approaching conflict points.
- Most roadways have destinations on both sides of the roadway. Since a sidepath serves only one side of the road, this requires sidepath users to cross the roadway midblock to access their destinations or to cross at intersections and ride on a sidewalk (if available) on the opposite side of the road. The former, while not difficult on low volume, low speed streets can be difficult on higher volume, higher speed roadways where sidepaths are likely to be built. The latter may not be legal in some locations.
- The proximity of sidepaths to the roadway may result in bicyclists riding at night being subject to glare from approaching car headlamps. This can make it difficult for the bicyclist to see hazards on the trail surface.

Operational problems associated with the visibility of the path user by motorists are most likely to be more significant on higher-speed, higher-volume, multilane roadways where motorists are focused on the motor vehicle traffic in the travel lanes (TRB, 2006).

13.3.13.1 Potential Mitigation Measures to the Operational Challenges of Sidepaths

Despite the safety, operational, and design challenges with sidepath design, there are times when they are unavoidable. They are often the preferred facility of the public. It may not be possible to improve the roadway to provide an adopted target level of bicycle accommodation. Alternatively,

they may be the only way to complete a bicycle network or close a gap in an otherwise continuous facility. Consequently, sidepath design must include measures to help minimize the operational challenges described in the previous section. The following geometric measures are the ones most likely to improve the operations and safety at sidepath conflict points.

- Divert the sidepath away from the parallel roadway at conflict points. Ideally, the path should be moved far enough away to function as a midblock crossing and be provided with the appropriate traffic control. At a minimum, enough space should be provided for one vehicle (25 feet) to queue between the roadway intersection and the crossing sidepath.
- Reduce the speeds of users on the sidepath. This can be done through horizontal alignment as described in Section 13.3.9.4.
- Reduce motor vehicle speeds at conflicts points. This can be accomplished by designing for the smallest design vehicle likely to commonly turn at the drive or intersection (AASHTO, 2018) and using the minimum radii provided for in Chapter 8 of this Guide.
- If feasible, reduce the operating speeds on the adjacent roadway.
- Where possible, eliminate conflicts with motor vehicles. Access management techniques, such as reducing the number of driveways or installing raised medians, reduces the potential conflict locations.
- Keep sight lines clear so that motorists approaching the conflict can clearly see the path users and path users can see approaching motorists. This requires limiting parking and landscaping around the conflict points. Proper sight distance should be provided.
- Where a sidepath crossing of a side street cannot be separated from the intersection of the side street and the roadway parallel to the sidepath by at least a car length, the crossing should be designed to be close to the adjacent road.
- At signalized intersections, consider installing blank-out signs, to be activated by path users (e.g., push buttons or loops) to alert motorists of their presence. NO RIGHT ON RED blank-out signs are appropriate for the near side street approach. YIELD TO PEDS IN CROSSWALK are appropriate for the adjacent right-turn, through-right, and opposing left-turn movements.

Individually, the above measures may not be sufficient to ensure the safety of sidepath users. It is likely that a combination of treatments is required (TRB, 2006). An additional measure is to provide signage to warn motorists of the adjacent path as shown in Figure 13-58.

Figure 13-58 Example Adjacent Path Sign



Unless they are moved to a midblock location, intersections of sidepaths with side streets and driveways are to be given the same priority as the parallel roadway. Installing STOP or YIELD signs at these locations is not an effective method of slowing or stopping path users at side streets and driveways. If path users perceive the signs as overly restrictive, they might not comply with them. Furthermore, motorists may yield to path users and wave them through in conflict with the sign priority at the intersection. The overuse of these signs may decrease their effectiveness at locations where compliance with STOP or YIELD signs is critical to the path users' safety.

13.3.14 Sidepath Clearance to the Adjacent Roadway

The minimum midblock separation between a roadway and sidepath is 5 feet from the back of curb or from the edge of pavement if no curb is present.

If 5 feet of separation cannot be provided, a suitable barrier should be provided. If placed, the barrier should be consistent with the requirements of Section 13.3.6. The location of the barrier shall not impair sight distance at intersections.

On low-speed roadways (45 mph or less), it is not necessary for the barrier to be designed to redirect errant motorists toward the roadway unless other conditions require a crashworthy barrier. If the railing cannot be designed so as to not be a hazard to motorists, it shall be protected by a guardrail or barrier wall.

It is not acceptable to mount a railing on top of a guardrail unless it has been appropriately crash tested.

On higher-speed roadways, barriers between the roadway and sidepaths must be crashworthy.

At some locations where the pathway is located more than 5 feet from a roadway, a guardrail may be placed between the roadway and the sidepath to protect motorists from an object in the clear zone. When a guardrail is located within 3 feet of the shared-use path, the back of the guardrail should be considered a vertical obstruction next to the path.

Snow storage should be considered when designing sidepaths. A separation distance of 8 feet is desirable to accommodate snow storage. Where space is limited, overall road cross section design must consider the likely amount of removed snow, the space needed to store it, and how snow will be managed. When snow is stored in the separation area between the road and shared-use path, at least three-fourths of the path should remain usable. The placement of barrier between the roadway and the shared-use path must consider the needs of snow removal and drainage.

13.3.15 Equestrian Facilities

Equestrian facilities may be included on some shared-use path projects. Shared bicycle, pedestrian, and equestrian use is relatively common. Care must be taken when designing these facilities to minimize the potential conflicts between equestrians and other users as horses can startle, compromising safety for their riders and other users. Where possible, separate trails or bridle paths should be provided for equestrian use.

For a complete discussion of equestrian planning and design, the designer should refer to the USDA document *Equestrian Design Guidebook for Trails, Trailheads, and Campgrounds* (USDA, 2007). The criteria contained within this section assumes an equestrian path is within the same right of way, but adjacent to a shared-use path.

13.3.16 Other Considerations on Bicycle Facilities

Where shared-use paths are used at night, lighting should be provided at intersections with roadways. The lighting should be consistent with requirements for roadway intersections contained in Section 5.0 of the CDOT *Lighting Design Guidelines for the Colorado Department of Transportation* (CDOT, 2019) or, as necessary, the AASHTO *Roadway Lighting Design Guide* (AASHTO, 2018). The CDOT *Lighting Design Guidelines for the Colorado Department of Transportation* is based upon the AASHTO *Roadway Lighting Design Guide* (AASHTO, 2018) and the IESNA (Illuminating Engineering Society of North America) recommended practices.

Even where paths are not open at night, it may be advisable to light roadway crossings. On-street bicycle lanes shall be lit to the same level as the adjacent roadway.

13.3.16.1 Maintenance of Traffic

Portable and permanent sign supports should not be located on bicycle facilities or areas designated for bicycle traffic. If the bottom of a secondary sign mounted below another sign is mounted lower than 7 feet above a pathway, the secondary sign should not project more than 4 inches into the pathway facility.

Bicyclists should not be exposed to unprotected excavations, open utility access, overhanging equipment, or other such conditions. Except for short duration and mobile operations, when a highway shoulder is occupied, a SHOULDER WORK sign (W21-5) should be placed in advance of the activity area. When work is performed on a paved shoulder 8 feet or more in width, channelizing devices should be placed on a taper having a length that conforms to the MUTCD requirements of a shoulder taper.

If a designated bike route is closed because of the work being done, a signed alternate route should be provided. The MUTCD includes approved Detour signs for bicycle facilities (Figure 13-59). Bicyclists should not be directed onto a sidewalk or exclusive pedestrian path.

Figure 13-59 Bicycle Facility Detour Signs



To maintain the systematic use of the fluorescent yellow-green background for pedestrian, bicycle, and school warning signs in a jurisdiction, the fluorescent yellow-green background for pedestrian, bicycle, and school warning signs may be used in Temporary Traffic Control zones.

13.3.16.2 Integration of Bicycles with Transit

Integration of bicycling with transit can increase the utility and extend the range of both modes. Bicyclists sometimes cite trip length, steep grades, and weather as reasons they do not use bicycling as a mode of transportation. By integrating bicycling and transit services, these barriers (real or perceived) can be overcome.

Bicycle racks on, or bicycle space within, transit vehicles can help integrate bicycling and transit. Providing short- and long-term bicycle parking (MUTCD) is a key aspect in making this integration.

Where a change in grade occurs at a transit station, some modifications may be considered to make the station accessible to bicyclists. Retrofitting a bicycle channel onto an existing staircase is one technique to improve bicycle access (City of Toronto, 2008) (Figure 13-60).

Figure 13-60 Bicycle Channel

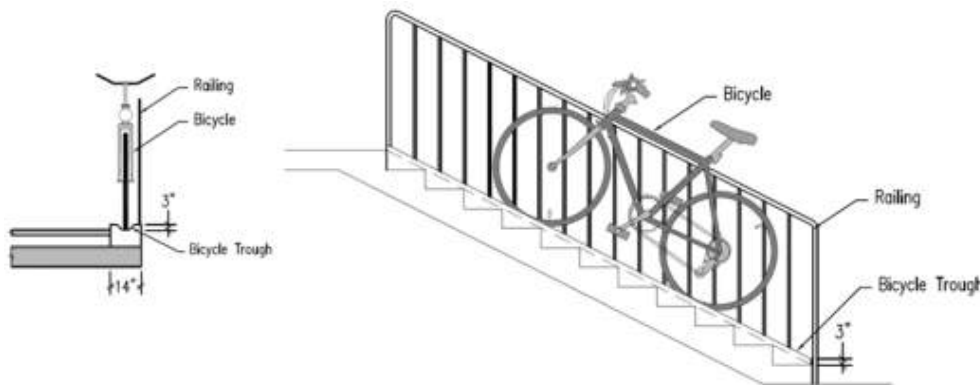

13.3.16.3 Shared Bicycle Facilities with Bus Transit

Shared bicycle-bus transit facilities can take multiple forms.

Ideally, a bus facility - exclusive busway or dedicated bus lanes - would be constructed with separate bicycle facilities. For an exclusive busway, this means the shared-use path adjacent the busway. Bicycle lanes can be installed adjacent to, and to the left of, a dedicated bus lane (assuming a right-side bus lane).

A shared bike-bus lane is one where bicycles use the same lane as the buses. Signage and symbols are used to mark that bicycles can use the designated bus lane (Figure 13-61). A sign similar to the Mandatory Movement Lane Control sign for a bus lane (R3-5gP) could be used. This sign would signify that the facility is both a bike lane and a bus lane.

Figure 13-61 Shared Bus Buffered Bike Lane

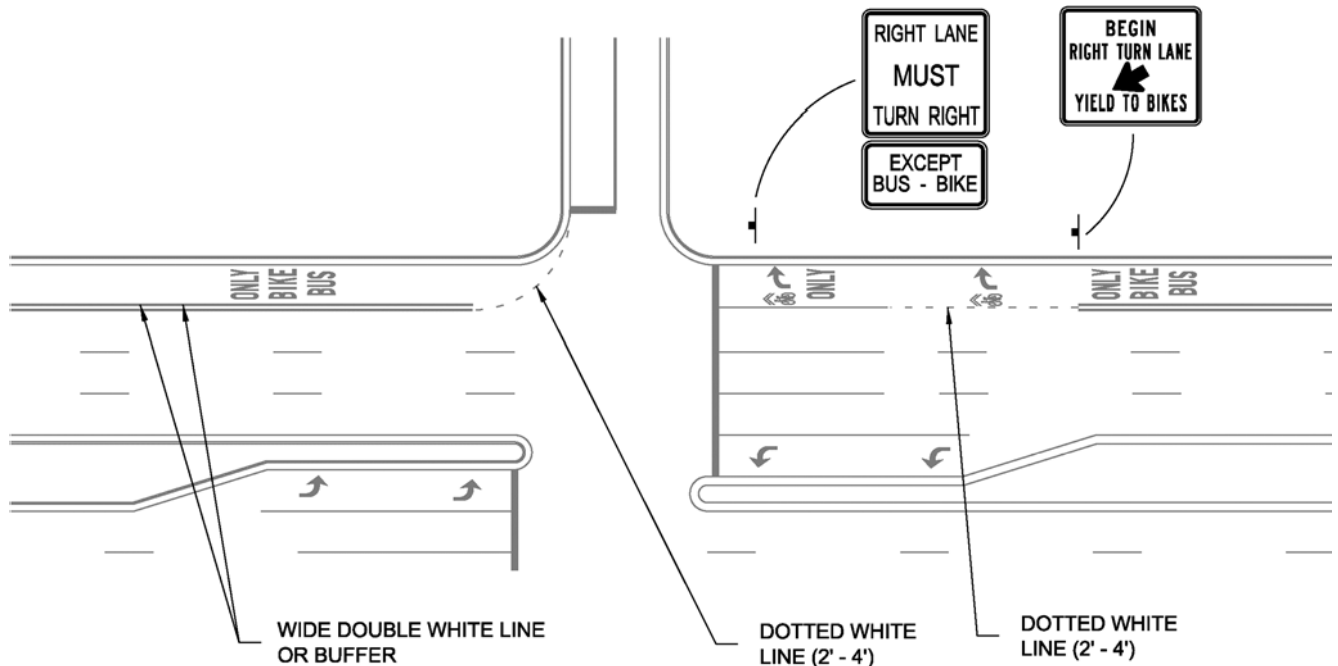

13.3.16.4 Shared Bicycle Facilities with Light Rail

If shared-use paths are constructed adjacent to a light rail transit line, special consideration must be given to crossings near the rail stops. Treatments to slow bicyclists should be installed in advance of these crossings. Shared-use paths adjacent to light rail should be located at least 5-foot clear of the dynamic envelope of the light rail transit vehicle. This results in the shared-use path being at least 11 feet clear of the rail line.

Barriers, as described in Section 13.3.6 should be provided between the light rail transit facility and the path where practical.

13.3.16.5 Innovative Signage and Markings

Numerous design treatments and traffic control devices are being used or tested to determine their effectiveness in promoting bicycling and improving bicycle safety. Several of these are discussed in this section.

The decision to use any of these treatments should be made in cooperation with local jurisdictions. Additionally, a justification for using the treatment should be included in the project file, including any research or supporting documents justifying the use of the treatment. Use of non-standard treatments require approval of the Resident Engineer. The headquarters Bicycle and Pedestrian Coordinator must be consulted on the use of these treatments to ensure uniform application throughout the state. Some treatments may require approval from FHWA.

13.3.16.6 Colored Bike Lanes

This treatment has obtained an Interim Approval from the FHWA for application. The interim approval assumes that the green coloring supplements bike lane striping and marking either at conflict areas or continuously along a bike lane. Where bike lanes are designated with dotted lines (i.e., at intersections), the green paint may be continuous. Coloring of bike lanes is a supplemental treatment and should be used to emphasize the presence of properly designed bike lanes. For further information, refer to MUTCD—Interim Approval for Optional Use of Green Colored Pavement for Bike Lanes (IA-14) (FHWA, 2011).

13.3.16.7 Bike Boxes

A bike box is a designated area for bicyclists at the head of a traffic lane at a signalized intersection that provides bicyclists with a safe, visible way to get ahead of traffic queues. It is located between the advance motorist stop line and the crosswalk or intersection. Designed to be used during the red phase, the box is intended to reduce car-bike conflicts, increase bicyclist visibility, and provide bicyclists with a head start when the light turns green. Bike boxes allow bicyclists to group together to clear an intersection quickly and may minimize impediments to other traffic at the onset of the green indication. Pedestrians may also benefit from reduced vehicle encroachment into the crosswalk when bike boxes are present.

At intersections with high numbers of conflicts between right-turning motorists and bicyclists, treatments other than or in addition to the bicycle box should be used. These may include separating conflicting traffic with a leading or exclusive signal and separating turning traffic from through traffic using exclusive turn lanes.

A bike box should be created by placing a stop line for motor vehicles a minimum of 10 feet in advance of the crosswalk or intersection. A minimum of one bicycle symbol marking should be placed in the bicycle box. A NO TURN ON RED sign should be installed wherever a bike box is placed in a lane from which turns on red would otherwise be permitted.

One concern about the use of bike boxes is how conflicts are addressed when the bicyclist arrives at the intersection just as the traffic signal is turning green for motorists. Motorists are not likely to expect a cyclist to move left from the bike lane when the light turns green. In Europe, where this treatment originates, motorists are given a yellow signal prior to the traffic signal turning green; this serves as a warning to the approaching bicyclist. Often, exclusive bicycle signals are provided for bicyclists when using the bike box treatments.

Another operational consideration is that of right-turning motorists who are required to approach the intersection from as close to the right-hand edge of the roadway as is practicable before making a right turn. In this situation, motorists may block the bike lane and thus the bicyclists' access to the bike box.

A request to experiment must be submitted to FHWA prior to implementing bike boxes.

Striping and marketing for a bike box are illustrated in Figure 13-62.

Figure 13-62 Example Striping and Marking for a Bike Box

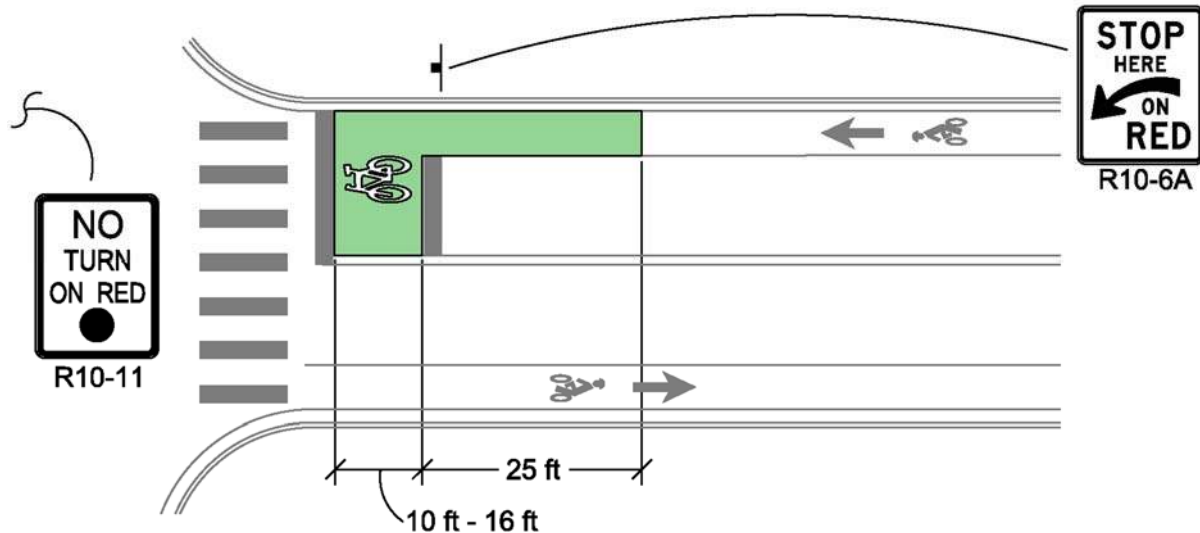

13.3.16.8 Bicycle Signals

The MUTCD allows the use of standard signal heads to control exclusive bicycle traffic movements. The use of bike-specific signal heads requires the use of directional signal heads, so it is clear which signal is meant for whom. A BIKE SIGNAL (tentatively an R10-10b) sign must be installed immediately adjacent to every bicycle signal face that is intended to control only bicyclists.

FHWA issued an interim approval memorandum for the use of bicycle signals (MUTCD—Interim Approval for Optional Use of a Bicycle Signal Face (IA-16)) (FHWA, 2013). These signals could be used to provide a leading bicycle interval at a traffic signal, an exclusive bicycle phase, an exclusive left-turn phase for bicycles on side paths, or as a signal for shared-use paths.

The FHWA interim approval states:

The use of a bicycle signal face is optional. However, if an agency opts to use bicycle signal faces under this Interim Approval, such use shall be limited to situations where bicycles moving on a green or yellow signal indication in a bicycle signal face are not in conflict with any simultaneous motor vehicle movement at the signalized location, including right (or left) turns on red.

The interim approval includes signal design, mounting, and operational requirements.

13.3.16.9 Maintenance of Bicycle Facilities

Maintenance of pavement surfaces is critical to safe and comfortable bicycling. Some of the following design treatments help minimize maintenance needs:

- Place public utilities, such as manhole covers and drainage grates, outside of bikeways.
- Ensure that drainage grates, if located on or near a bikeway, have narrow openings and that the grate openings are placed perpendicular to the riding surface (Figure 13-29).

- Design of appropriate cross slopes to help to keep the riding surface clear of debris and water.

13.3.16.9.1 Snow and Ice Control

Roads should be designed to provide snow storage. The roadside should have adequate space to place plowed snow so that it does not block an adjacent shared-use path or bike lane. Separation between road and path allows for snow storage.

13.4 Pedestrian Facilities

Pedestrians and their interactions with vehicular traffic are major considerations for highway planning and design (AASHTO, 2018). Pedestrians are part of every roadway environment and should be accommodated in all roadway designs. According to the 2018 AASHTO GDHS:

Because of the demands of vehicular traffic in congested urban areas, it is often very difficult to make adequate provisions for pedestrians. Yet provisions should be made, because pedestrians are the lifeblood of our urban areas, especially the downtown and other retail areas.

Therefore, all design projects on CDOT facilities shall include accommodations for pedestrians.

13.4.1 General Pedestrian Considerations

Pedestrian accommodations can take any number of forms. In urban areas, pedestrian accommodations are most likely sidewalks or shared-used paths. In rural areas with lower traffic volumes and light pedestrian traffic, paved shoulders may be used to accommodate pedestrians. CRS 42-4-805 states:

“Pedestrians walking or traveling in a wheelchair along and upon highways where sidewalks are not provided shall walk or travel only on a road shoulder as far as practicable from the edge of the roadway.”

As such, if the intended pedestrian accommodation is a shoulder, the shoulder shall be designed to meet ADA and PROWAG requirements. The degree of pedestrian accommodation provided is influenced by the existing and future land use patterns surrounding the facility.

13.4.1.1 Accommodating Pedestrians in the Right of Way

The level of accommodation for pedestrians can be measured by a number of methods ranging from subjective to objective.

Often, as part of downtown redevelopment projects or Safe Route to School projects, a walking audit, which includes subjective and objective analyses, will need to be performed. A walking audit documents recommended improvements to the roadway and pedestrian facilities to improve pedestrian accommodation. Any such local plans should be reviewed and the recommendations addressed in the design plans to the maximum extent feasible.

The *Highway Capacity Manual* (TRB, 2022) establishes an objective method for determining the level of pedestrian accommodation based upon the geometric and operational characteristics of the roadway being analyzed. This method is based on numerous research projects that quantified which factors influence how pedestrians perceive a roadway and sidewalk safety and comfort. This method is often used by agencies to set minimum target levels of accommodation for pedestrian facilities. The model for links (roadway segments between intersections) includes the following factors:

- Presence and width of a sidewalk.
- Width of the outside lane.
- Presence and width of a paved shoulder or bike lane.
- Presence and width of a parking lane.
- Percent of parking occupied by parked cars.
- Presence of trees or a barrier between the sidewalk and the roadway.
- Operating speeds on the roadway.
- Traffic volume on the roadway.

The primary geometric conditions that are influenced by design are the presence of a sidewalk, sidewalk width, and the separation of the sidewalk from the outside lane. This *Highway Capacity Manual* method is a useful tool for designing cross sectional geometry to meet a target level of pedestrian accommodation.

The *Highway Capacity Manual* (TRB, 2022) also provides a method for determining the level of service based upon sidewalk congestion. This methodology should be used to ensure that there is adequate sidewalk width where high volumes of pedestrians are expected.

13.4.1.2 Operating Characteristics of Pedestrians

There is no single type of design pedestrian. Pedestrians have varying degrees of physical and cognitive abilities. It is important to recognize this diversity during facilities design.

Typical pedestrian walking speeds range from approximately 2.5 feet per second to 6.0 feet per second. The MUTCD states that a speed of 3.5 feet per second should be used for calculating pedestrian clearance intervals at pedestrian signals while a speed of 3.0 feet per second should be used for the total pedestrian crossing phase (MUTCD). Seasonal factors, such as ice and snow, can reduce travel speeds below the recommended speeds.

The space taken up by a single stationary person can be approximated by an ellipse of 1.5 feet x 2 feet, with a total area of 3 square feet. In evaluating a pedestrian facility, the *Highway Capacity Manual* (TRB, 2022) assumes an area of 8 square feet, including a buffer zone, for each pedestrian (ODOT, 1995). Two pedestrians walking side by side require a minimum of 4.7 feet of width. Two people in wheelchairs passing each other need a minimum of 5 feet of width; if each has an assistive animal, 8 feet of width is required.



According to the AASHTO *Guide for the Planning, Design, and Operation of Pedestrian Facilities* (AASHTO, 2004),

In 1994, an estimated 7.4 million persons in the United States used assistive technology devices for mobility impairments, 4.6 million for orthopedic impairments, 4.5 million for hearing impairments, and 0.5 million for vision impairments. These numbers are expected to increase because there is a positive correlation between an increase in age and an increase in the prevalence rate of device usage. For example, persons who are 65 years and over use mobility, hearing, and vision assistive devices at a rate four times greater than the total population (TRB, 2009).

These pedestrians shall be considered in the design of pedestrian facilities.

13.4.1.3 Americans with Disabilities Act Requirements

The Americans with Disabilities Act (ADA) mandates the accommodation of persons with disabilities in pedestrian facility design through the provision of pedestrian access routes.

A pedestrian access route is a continuous and unobstructed walkway within a pedestrian circulation path that provides accessibility.

The standards for accessible routes are set by the U.S. Access Board in the Americans with Disabilities Act Architectural Guidelines for Buildings and Facilities (ADAAG) (U.S. Access Board, 2002). ADA standards for new construction and alterations were primarily developed for buildings and site work and are not easily applied to the public right of way. In 2011, the U.S. Access Board released the PROWAG (U.S. Access Board, 2011). It is identified as best practice for accessible pedestrian design and was formally adopted by CDOT as the standard for curb ramps. The criteria contained within this Guide comply with PROWAG; notations are made when they vary from ADAAG.

All newly designed and newly constructed pedestrian facilities located in the public right of way shall comply with these requirements. All altered portions of existing transportation facilities located in the public right of way shall comply with these requirements to the maximum extent feasible.

If it is technically infeasible to comply with the requirements of the ADA, documentation shall be made to the file to fully justify any non-compliant features of a design. Right of way acquisition does not qualify as technically infeasible, but shall be purchased if needed to make a curb ramp compliant.

13.4.1.4 Curb Ramps and Blended Transitions

Curb ramps shall be installed where a pedestrian access route crosses a raised curb that vertically separates pedestrians from vehicles. Where sidewalks are not separated from the roadway with curb, such as on roadways with open shoulders, the at-grade connection between the sidewalk and roadway is referred to as a blended transition.

Refer to Chapter 12 of this Guide and the latest edition of the CDOT M&S Standards for more information.

13.4.1.5 Vertical Changes in Grade

The maximum instantaneous elevation change on a pedestrian access route without a treatment is one-quarter inch. Changes in level between one-quarter to one-half inch shall be beveled at a slope of no greater than 2:1. The bevel shall be applied across the entire vertical surface discontinuity. Changes in elevation greater than one half inch shall be designed with a maximum slope of 5%.

13.4.2 Sidewalks

When the design is in any of the urban context classifications for roads or streets, sidewalks are required on both sides of CDOT roadways.

Sidewalk surfaces shall be firm, stable, and slip resistant. Concrete sidewalks shall have a broom finish perpendicular to dominant pedestrian direction of travel to increase skid resistance.

The pedestrian access route along a sidewalk should be designed to maximize straight through movements by pedestrians without the need to divert around utilities, street furniture, or driveways.

Adopted pedestrian plans shall be consulted to determine if a roadway is to be designed with pedestrian facilities. CDOT projects should implement relevant pedestrian plan facility recommendations to the maximum extent possible.

Sidewalks should be provided on those projects where other factors indicate a need.

13.4.2.1 Separation from Roadway

The separation of a sidewalk from a roadway is an important factor in the perceived safety and comfort of a pedestrian facility (TRB, 2022). The greater the separation from the roadway, the more pleasant the facility and, consequently, the more likely it is to be used by pedestrians.

Separation from the roadway provides benefits beyond the perceived safety and comfort of the pedestrian. Safety is improved by increasing separation from the roadway, particularly on roadways without curb and gutter. A buffer area provides a place to construct curb ramps and driveways outside of the sidewalk area, making it easier to comply with ADA. Buffer areas can also be used for snow storage. Utility poles, parking meters, and signs can be placed in a sufficiently wide buffer, thus ensuring the complete sidewalk width is available for pedestrians.

13.4.2.2 Separation from Roadway with Curb and Gutter

If a roadway is included in an adopted pedestrian plan, the designed separation of the pedestrian facility from the roadway should comply with target values presented in the plan. Target values may be in the form of adopted minimum separations distances (for example, a buffer, shown in

Figure 13-62) or in target level of service values. For minimum level of service values, the separation needs to be calculated based upon roadway and traffic characteristics.

The minimum setback of a sidewalk from the back of curb to accommodate the construction of a perpendicular curb ramp outside of the sidewalk is 7.9 feet. Where possible, this separation should be provided between the back of curb and sidewalk on curb and gutter projects.

The minimum width of setback to a sidewalk on an arterial roadway with curb and gutter is 6 feet. Under constrained conditions, this may be reduced to 5 feet. The minimum width of setback to a sidewalk on a local or collector roadway with curb and gutter is 4 feet. In extremely constrained conditions, after all motor vehicle travel lane widths have been reduced to their minimums, this may be reduced to 2 feet.

Minimum separation to the sidewalk may be dictated by requirements for snow storage. Regional snow storage requirements should be considered when determining the minimum setback.

Where local jurisdictions are required to maintain the buffer and sidewalk area, maintenance agreements should be obtained during pre-construction.

13.4.2.3 Separation from Roadway without Curb and Gutter

If the project's limits are included in an adopted pedestrian plan, the separation of the pedestrian facility from the roadway should comply with target values presented in the plan.

Sidewalks on roadways without curb and gutter should be placed as far from the roadway as practical in the following sequence of desirability (FHWA,2009):

- As near the right of way line as possible.
- Outside of the clear zone.
- Five feet from the shoulder point.
- As far from edge of traffic lane as practical.

13.4.2.4 Sidewalk Width

The minimum width for sidewalks on CDOT projects is 5 feet exclusive of the width of the curb.

Under constrained conditions, the minimum width may be reduced to 4 feet exclusive of the width of the curb. This is the minimum pedestrian access route width allowed by PROWAG (U.S. Access Board, 2011). The ADAAG allows for a minimum accessible route of 3 feet in width (U.S. Access Board, 2002) for on-site building facilities. Where less than 5 feet continuous width is provided, passing spaces shall be provided at intervals of 200 feet maximum. Passing spaces shall be a minimum of 5 feet wide for a distance of 5 feet parallel to the sidewalk direction.

13.4.2.5 Protruding Objects

Protruding objects, including pedestrian amenities such as street furniture, water fountains, and informational kiosks, shall not reduce the width of the sidewalk to less than 4 feet.

Objects with leading edges more than 27 inches and not more than 80 inches above the sidewalk shall not protrude more than 4 inches into the clear pedestrian path (Figure 13-63). Objects protruding more than 4 inches into the pedestrian path at more than 27 inches above the sidewalk may not be detectable by cane. Maintaining at least 80 inches clear to overhangs provides clear space to walk under protrusions for most pedestrians.

Objects mounted on free-standing posts or pylons, 27 inches minimum and 80 inches maximum above the sidewalk, shall not overhang into the clear pedestrian path more than 4 inches beyond the post or pylon base measured 6 inches above the sidewalk. Where a sign or other obstruction is mounted between posts or pylons and the clear distance between the posts or pylons is greater than 12 inches, the lowest edge of such sign or obstruction shall not be more than 27 inches or less than 80 inches above the sidewalk.

Where the vertical clearance to an obstruction is less than 80 inches, guardrails or other barriers shall be provided. The leading edge of such guardrail or barrier shall be located not more than 27 inches above the sidewalk.

Figure 13-63 Protruding Objects

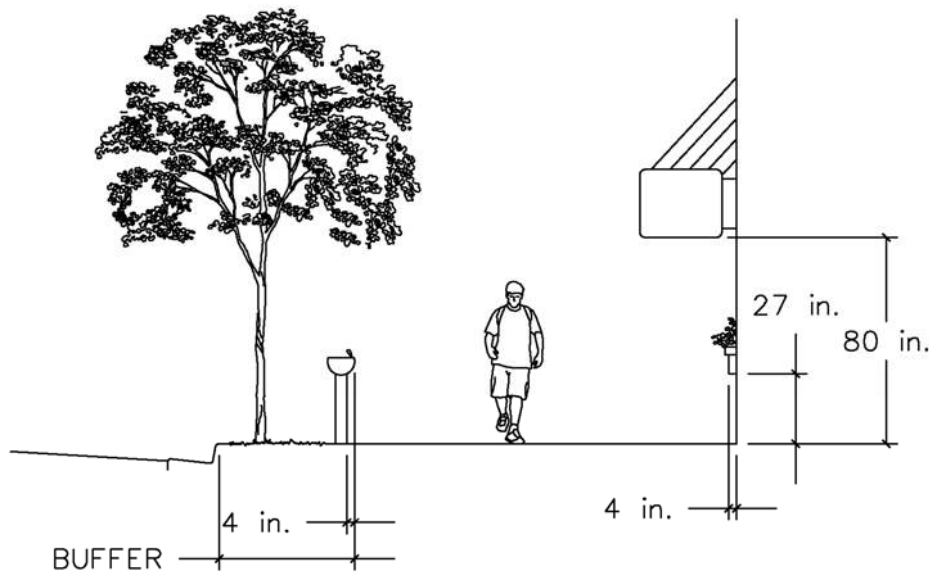

13.4.3 Grade and Cross Slopes

The grade of a sidewalk should not exceed the general grade established for the adjacent street or highway.

On structures and constructed approaches thereto, with grades exceeding 5%, pedestrian ramps with a maximum slope of 8.33% and a maximum rise of 30 inches between resting intervals shall be provided. Resting intervals shall be a minimum of 5 feet measured longitudinally along the sidewalk.

The maximum cross slope for a sidewalk is 2%. Care must be taken such that the cross slope and longitudinal grade provide adequate drainage for rain and snowmelt from the sidewalk.

13.4.4 Driveways

Where a driveway crosses a sidewalk, the path of the pedestrian across the driveway must comply with the width and cross slope requirements of Section 13.4.2.4 and Section 13.4.3.

13.4.5 Sidewalk Lighting

Sidewalk alignments must be considered when designing the roadway lighting pattern. Sidewalks along roadways should be illuminated to the same level as the adjacent roadway. This is important as pedestrians coming from the side of the road to cross must be adequately illuminated to be visible to motorists.

Roadway lighting designed to light just the travel lanes to design levels may not provide adequate illumination for sidewalks. In these cases, supplemental lighting should be provided.

This lighting shall be consistent with requirements for walkways contained in Section 5.11 of the *CDOT Lighting Design Guidelines for the Colorado Department of Transportation* (CDOT, 2019), or, as necessary, the *AASHTO Roadway Lighting Design Guide* (AASHTO, 2018).

13.4.6 Transit Stops

Where possible, transit waiting areas should be located outside of the sidewalk. Transit pads shall be connected to the street, sidewalk, or pedestrian path by an *accessible* route.

Bus stop boarding and alighting areas shall provide a clear length of 8 feet minimum, measured perpendicular to the curb or roadway edge, and a clear width of 5 feet minimum, measured parallel to the roadway.

13.4.7 Pedestrian Crossings of Roadways

Careful design of roadway crossings is critical to pedestrian mobility and safety. Pedestrian crossings should be designed so that they are convenient for users otherwise pedestrians might choose to cross at other locations, outside the protection of a crosswalk.

ADA-compliant curb ramps or blended transitions shall be installed wherever a pedestrian access route crosses a roadway.

13.4.8 Pedestrian Crossings at Intersections

Motorists approaching intersections are primarily concerned with conflicts with other motorists. Consequently, it is important that pedestrians waiting at intersections and approaching motorists have adequate sight distance to allow each user to make appropriate decisions.

In urban areas, the minimum curb radii allowed for the design vehicle, as found in Chapter 8 of this Guide, should be used. This reduces vehicle speeds and pedestrian crossing distances. Curb

extensions should be considered to reduce crossing distances at intersections on streets with on-street parking.

13.4.8.1 Pedestrian Crossings at Uncontrolled Approaches to Intersections

Designated pedestrian crossings of uncontrolled approaches to intersections should be designed as midblock crossings. Guidance on these crossings can be found in Section 13.4.9.

13.4.8.2 Pedestrian Crossings at Stop and Yield Control Intersections

In urbanized areas, marked crosswalks should be provided wherever a sidewalk crosses a street under stop or yield control. STOP or YIELD lines shall be placed a minimum of 4 feet in advance of the crosswalks.

On multilane roadways under yield control, YIELD lines should be placed 30 feet in advance of the near edge of the intersecting roadway. This advance placement is to improve the visibility of crossing pedestrians to motorists.

13.4.8.3 Pedestrian Crossings at Signal Control Intersections

If an intersection under signal control has sidewalks, marked crosswalks should be provided. In urban areas, pedestrian signals are recommended at all intersections where sidewalks on the approaches to a signalized intersection. STOP lines shall be placed a minimum of 4 feet in advance of the crosswalks. Consideration may be given to providing advance right-turn STOP lines to improve the visibility of pedestrians coming from the motorist's left.

Pedestrian push buttons shall be accessible to pedestrians via an accessible pedestrian route in compliance with the ADA.

PROWAG requires that whenever pedestrian signals are installed, accessible pedestrian signal push button be installed (U.S. Access Board, 2002). At intersections with high volumes of right-turning traffic, raised right-turn channelization islands should be provided to allow pedestrians to cross the right-turning traffic independently of the rest of the intersection. Single right-turn channelization islands should be under yield control and have YIELD lines a minimum of 4 feet in advance of the crosswalk. Pedestrian crossings, crosswalks, and W11-2 (PEDESTRIAN CROSSING sign) should be placed on the approach end of the channelization island to maximize visibility to motorists. Where there is concern about motorists yielding to pedestrians, a raised crossing between the sidewalk and the channelization island should be considered to improve visibility of the pedestrians and reduce motor vehicle speeds in that conflict area. Space should be provided beyond the crosswalk for a single motor vehicle to store. Pedestrian signal heads for crossing of the through lanes shall be placed on the concrete channelization island.

Painted channelization islands do not provide the pedestrian advantages of raised channelization islands. Signal poles cannot be placed in painted islands. Consequently, the pedestrian signal necessarily applies to the entire crossing, not just the through lanes. This precludes the use of yield control on the slip lane and the right turn must be signalized.

At multilane right-turn channelization islands, PROWAG requires the use of APS across the turn lanes (U.S. Access Board, 2002). Refer to the MUTCD Section 4.E.

At intersections with high volumes of pedestrians, consideration should be given to restricting the right turn on red movement. NO RIGHT ON RED blank-out signs may be used to restrict right turns only when pedestrians have pushed the pedestrian push button. This minimizes the delay to motorists due to the right-turn restriction.

Additionally, YIELD TO PEDS IN CROSSWALK blank-out signs can be used to remind motorists turning right-on-green and taking permissive left-turn movements of the law that requires motorists to yield to pedestrians in the crosswalk.

Another method to reduce pedestrian conflicts with turning motorists is to use a leading pedestrian interval. Where leading pedestrian intervals are used, APS should be considered.

13.4.8.4 Pedestrian Crossings at Roundabouts

Research suggests that properly designed single-lane roundabouts have fewer pedestrian conflicts and crashes than typical signalized intersections (FDOT, 2010). To accommodate pedestrians, roundabouts should be designed to reduce speeds of approaching vehicles. Design speeds through single-lane roundabouts of 12 to 22 mph are typical.

Crosswalks at roundabouts shall be placed a minimum of 20 feet back from the circulating roadway (Figure 13-64).

In areas prone to snow where the crosswalks may not be visible in winter, the W11-2 (PEDESTRIAN CROSSING) sign assembly should be installed at the crosswalks.

PROWAG requires crosswalks across multilane approaches to roundabouts to be provided with APS (U.S. Access Board, 2002).

Figure 13-64 Location of Pedestrian Crossings at Roundabouts

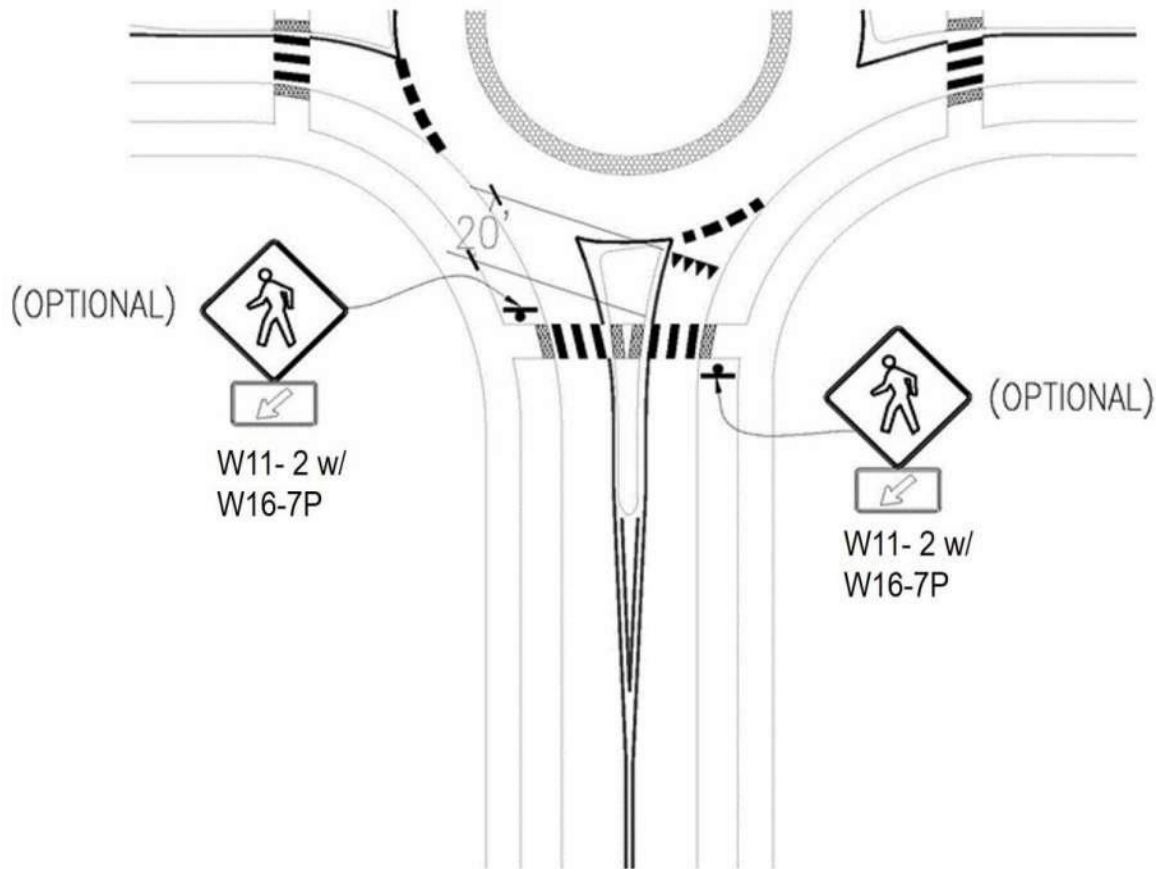

13.4.9 Pedestrian Crossings at Midblock Locations

When pedestrian crossing volumes meet the warrants for signalized pedestrian crossings, the installation of traffic signals for pedestrians should be considered.

The minimum clear width between crosswalk lines is 6 feet.

The MUTCD provides information on what type of traffic control devices may be used at midblock crossings. However, other than requiring crosswalk markings and PEDESTRIAN WARNING (W11-2) signs, it provides no clear guidance about the conditions in which any particular traffic control devices are recommended to be used to ensure that a motorist yields. The following section provides guidance in this regard. The tables provided should not be taken as requirement, rather as guidance for determining appropriate levels of traffic control at midblock crossings.

White, retroreflective crosswalk pavement markings shall be installed at all midblock crossings.

Raised median pedestrian refuge islands should be installed at all midblock crossing locations where the pedestrian must cross four or more lanes of traffic. The minimum raised separation width between travel lanes for a pedestrian refuge island is 6 feet. For shared-use path crossings, the desirable minimum width of a refuge island is 10 feet. Where crossings are cut through median

refuge islands, detectable warnings shall be installed: 2 feet of detectable warnings, 2 feet flat surface minimum, and 2 feet of detectable warnings. Refer to Figure 13-65.

Ideally, raised islands should extend along the roadway in advance of the crossing to the STOP or YIELD line.

Figure 13-65 Detectable Warning Placement in Median Refuge Islands

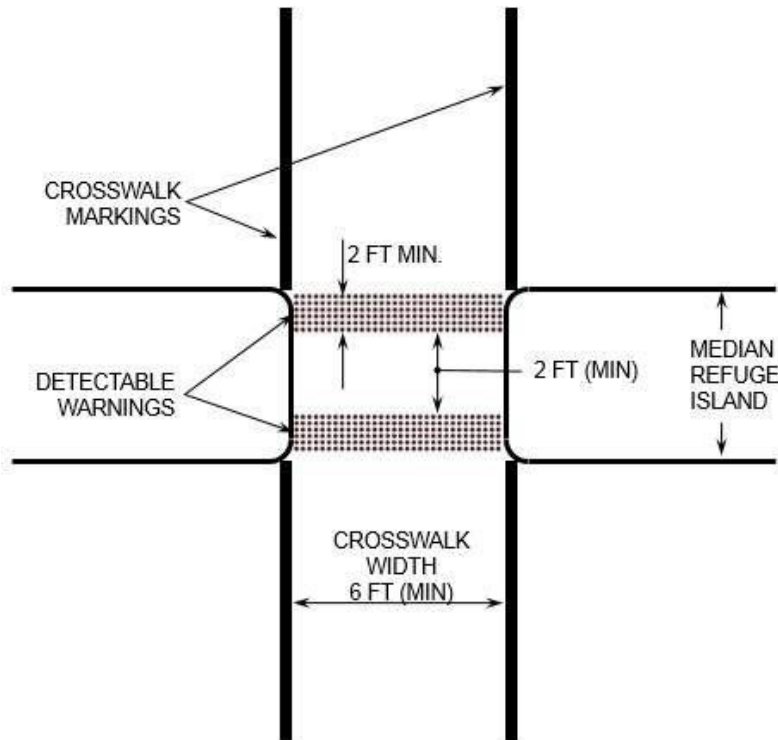

An angled cut through of the median provides additional space for pedestrians to stage and encouraging pedestrians to look toward oncoming traffic (Figure 13-66).

Advance STOP or YIELD lines shall be installed at all midblock crossing locations where the pedestrian must cross four or more lanes of traffic.

Figure 13-66 Angle Cut through a Median

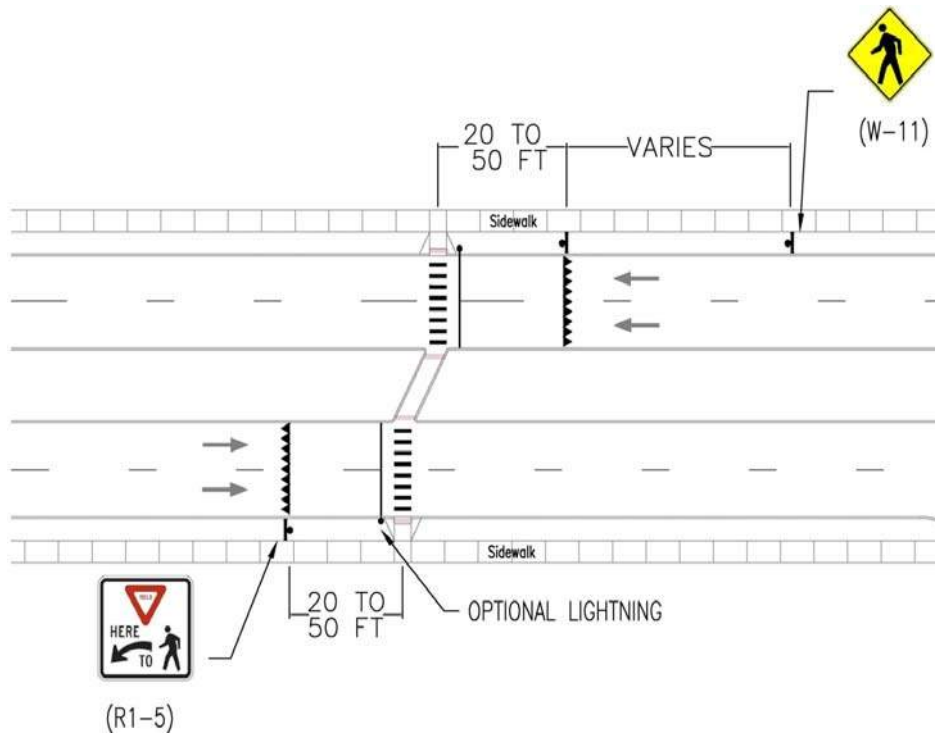

13.4.9.1 Rapid Rectangular Flashing Beacons

While not yet included in the MUTCD, Rapid Rectangular Flashing Beacons (RRFB) have been shown to improve motorist yielding at midblock crossings. Research suggests motorist yield rates are ranging from 80% to 97% three years after deployment. To date, this appears to be the most effective combination of traffic control devices that do not actually require the motorist to stop. This treatment has an Interim Approval from FHWA for its application (MUTCD—Interim Approval for Optional Use of Pedestrian-Actuated Rectangular Rapid Flashing Beacons at Uncontrolled Marked Crosswalks (IA-21) (FHWA, 2018).

The RRFB treatment is a combination of signing, markings, and pedestrian-activated strobe and feedback devices. Signing for the RRFB typically includes advance PEDESTRIAN WARNING signs (W11-2) with AHEAD supplemental plaques (W16-9p), and PEDESTRIAN WARNING signs (W11-2) with down arrow supplemental plaques (W16-7p). Pavement markings include yield lines and solid white lane lines (on divided multilane roads); the length of these lines is dependent upon the design stopping sight distance for the roadway. The pedestrian activated treatments would be the W11-2 signs with built in rectangular strobe flashers. Additionally, pedestrian visible strobes and a recorded message inform pedestrians when the crossing is activated and instruct them to wait for motorists to yield.

The RRFB should not be used on roadways with more than four through lanes. Raised medians should be provided at crossings using the RRFB to provide a space for left-hand signs to be installed.

The R1-5 (YIELD HERE TO PED) shall be placed so that it does not restrict motorists' visibility of the RRFB at the crosswalk.

For the placement of advance stop lines and advance warning signs, refer to the MUTCD.

High visibility crosswalks are to be used with the RRFB crossing treatment, as shown in Figure 13-67.

Figure 13-67 Rapid Rectangular Flashing Beacon

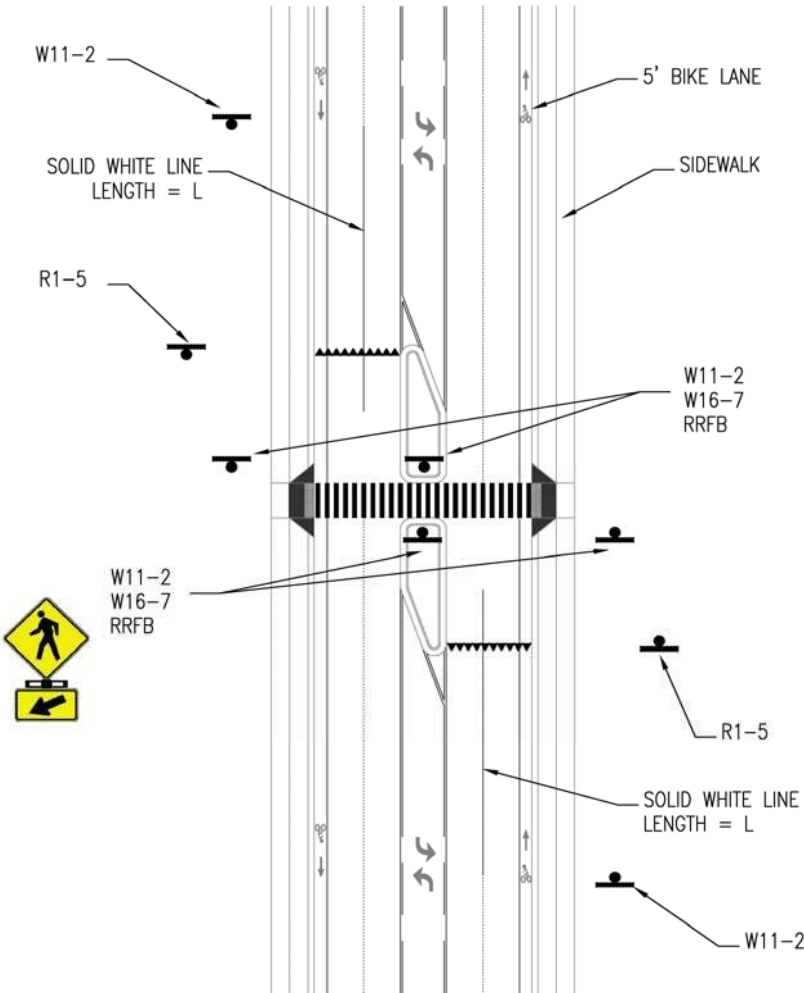

Timing of the flashing beacon should allow for pedestrians to scan for motorists, step from the side of the road, and completely cross the street. Depending upon pedestrian volumes, 5 to 10 seconds should be provided for pedestrians to scan for gaps and enter the roadway. For areas with very high pedestrian volumes (more than 10 pedestrians per crossing), additional startup time should be provided. A speed of 3.5 feet per second should be assumed for pedestrians unless there is a high number of children or elderly pedestrians expected to use the crosswalk.



13.4.9.2 Pedestrian Hybrid Signals (HAWK Signals)

PEDESTRIAN HYBRID BEACONS are pedestrian-activated beacons that warn motorists that pedestrians are crossing the street and indicate that motorists are required to stop for pedestrians (FHWA,2009). They do not require the satisfaction of traffic signal warrants. Chapter 4F of the MUTCD does provide some guidance regarding the volume of pedestrians crossing a roadway that would merit the consideration of a PEDESTRIAN HYBRID BEACON (FHWA,20002000).

PEDESTRIAN HYBRID BEACONS are required for use on unsignalized designated crossings of roadways with six or more lanes.

The signal sequence for a pedestrian hybrid signal is shown in Figure 13-68.

Figure 13-68 Pedestrian Hybrid Beacon Sequence

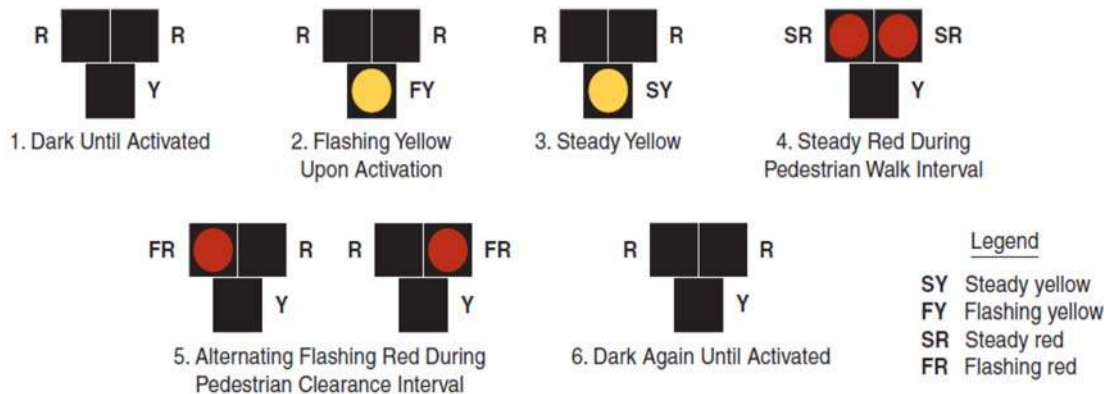

13.4.9.3 Guidance for Traffic Control Selection at Midblock Crossings

The recommended traffic control method is determined by the traffic volume levels in the lanes being crossed. The threshold volumes for low- to medium-volume is determined using the amount of time a pedestrian can expect to wait for an adequate gap in traffic to cross the street. The medium- to high-volume threshold is based upon a midblock crossing safety study prepared by the University of North Carolina’s Highway Safety Research Center (FHWA,2009). Depending on whether the street being crossed is low, medium or high volume, the corresponding value listed in Table 13-11 should be referenced to determine the recommended traffic control devices for the crossing.

Table 13-11 Referral Table for Midblock Crossing Treatments

Traffic Volume in Lanes Being Crossed	Recommended Traffic Control
< 6,700 vehicles per day	Refer to Table 13-13
6,700 - 12,000 vehicles per day	Refer to Table 13-14
>12,000 vehicles per day	Refer to Table 13-15



Three tiers of traffic control device packages were identified for these guidelines: static signs, activated signs, and hybrid beacons. The components of each of these packages are provided in Table 13-12.

Table 13-12 Traffic Control Devices Tiers

Preferred Traffic Control Devices	Midblock Crossing Traffic Control Devices Tier		
	Static Signs	Activated Signs	Stop Controlled
--			
Marked Crosswalks	✓	✓	✓
Bicycle or Pedestrian Warning sign with Trail Xing Sign (W11-15) w/ (W11-15) Or Arrow (W16-7p)	✓	✓	✓
Advance Yield or Stop Lines	✓	✓	✓
Trail Xing Sign (advance) and TRAIL XING Pavement Marking	✓	✓	✓
Yield or Stop Here to Ped Signs (R1-5)(R1-5)	✓	✓	✓
RRFB crossing: Ped Xing Signs (W11-2) with rapid rectangular flashing beacons, and solid centerlines on approaches		✓	
Pedestrian Hybrid Beacon			✓

The matrices on the following pages present packages of traffic control devices recommended for specific roadway conditions. While providing guidance, there are sometimes field conditions which make the strict adherence to any typical signing and marking scheme impractical. Therefore, when applied at new locations, each location should be reviewed in the field to ensure the proposed treatments are appropriate.

If sight distance is limited, additional traffic control may be appropriate.

Additional traffic control may be appropriate in areas where expected pedestrians are predominately school children or individuals with mobility impairments.

General notes for the Crossing Treatment Guidelines matrices shown in Table 13-13, Table 13-14, and Table 13-15.

- Each column in the table represents a package of traffic control devices recommended for the specific crossing condition.
- Volumes in the title cells assume a daily to peak hour volume factor of 0.97.
- The designation of “YES” for the median assumes there is potential for installing a raised median at the crossing location and that one will be installed. Raised medians that can be used as pedestrian refuges (6 feet wide or wider in the direction of the roadway cross section) will require less restrictive motor vehicle traffic controls in conjunction with the midblock crossings. Wider refuge islands, 10 feet or more, should be considered to accommodate bicycle with trailers and recumbent bicycles.
- On roadways with two-way left-turn lanes, refuge islands should be installed at crossing locations to improve pedestrian refuge safety.
- On multilane roadways with medians on the approach, crossing signs for motorists should be placed in the medians as well as on the side of the roadway.
- The use of angled cuts through the median (sometimes referred to as Danish offsets) should be considered at all crossings with raised medians for two reasons. First, the offset through the median directs the path users’ attention toward the traffic about to be crossed. Secondly, of particular importance when using these tables for shared-use path intersections, by providing an angled cut through the median, longer users (tandems, cargo bikes, & bicycles with trailers) will be better accommodated than in a narrower median.
- When advance yield lines are used on the approach roadways, they should be used in conjunction with solid lane lines. The lane lines should extend a distance equal to the stopping sight distance back from the yield lines. This is to enable law enforcement officers to determine when a motorist fails to yield when he could have done so.
- On six-lane, undivided roadways, strong consideration should be given to providing a signalized crossing of the roadway for pedestrians. Until such time as this can be achieved, aggressive channelization should be used to divert pathway users to the nearest safe crossing.

This guidance assumes that lighting is provided for crossings at night.



Table 13-13 Roadway Volume Less Than 650 Vehicles Per Hour (vph) or 6,700 Vehicles Per Day (vpd)

Lanes	2 lanes						4 lanes					
	No			Yes			No			Yes		
Median	≤ 30 mph	35–40 mph	≥ 45 mph	≤ 30 mph	35–40 mph	≥ 45 mph	≤ 30 mph	35–40 mph	≥ 45 mph	≤ 30 mph	35–40 mph	≥ 45 mph
Traffic Control Devises Package	Static Signs	✓			✓	✓	✓			✓		
	Rectangular Rapid Flashing Beacon		✓	✓				✓		✓	✓	✓
	Hybrid Beacon											

Table 13-14 Roadway Volume Greater than 650 vph (6,700 vpd) and Less Than 1,150 vph (12,000 vpd)

Lanes	2 lanes						4 lanes						6 lanes					
	No			Yes			No			Yes			No			Yes		
Speed	≤ 30 mph	35–40 mph	≥ 45 mph	≤ 30 mph	35–40 mph	≥ 45 mph	≤ 30 mph	35–40 mph	≥ 45 mph	≤ 30 mph	35–40 mph	≥ 45 mph	≤ 30 mph	35–40 mph	≥ 45 mph	≤ 30 mph	35–40 mph	≥ 45 mph
Traffic Control Devises Package	Static Signs	✓			✓					✓								
	Rectangular Rapid Flashing Beacon		✓	✓		✓	✓			✓	✓							
	Hybrid Beacon							✓	✓				✓	✓	✓	✓	✓	✓

Table 13-15 Roadway Volume Greater Than 1,150 vph (12,000 vpd)

Lanes	2 lanes						4 lanes						6 lanes					
	No			Yes			No			Yes			No			Yes		
Speed	≤ 30 mph	35–40 mph	≥ 45 mph	≤ 30 mph	35–40 mph	≥ 45 mph	≤ 30 mph	35–40 mph	≥ 45 mph	≤ 30 mph	35–40 mph	≥ 45 mph	≤ 30 mph	35–40 mph	≥ 45 mph	≤ 30 mph	35–40 mph	≥ 45 mph
Traffic Control Devises Package	Static Signs				✓													
	Rectangular Rapid Flashing Beacon	✓	✓	✓		✓	✓			✓	✓	✓						
	Hybrid Beacon							✓	✓				✓	✓	✓	✓	✓	✓

13.4.9.4 Additional Treatments at Midblock Crossings

On roadways with on-street parking, mid-block curb extensions should be considered to reduce pedestrian crossing distances and improve pedestrian and motorist sight lines. Drainage must be addressed when designing curb extensions.

On lower speed and volume arterials and collector streets, raised crosswalks should be considered. Raised crosswalks decrease motorist speeds, resulting in greater yielding rates. Snowplow operators have reported problems plowing over raised crosswalks; the use of short vertical curves instead of grade break lines may address this operational problem. Drainage must be considered when designing raised crosswalks.



The approach slopes for raised crosswalks shall be marked in accordance with the required markings required by MUTCD for raised pedestrian crossings shown in Figure 13-69.

Figure 13-69 Approach Slope Markings for Raised Pedestrian Crossings

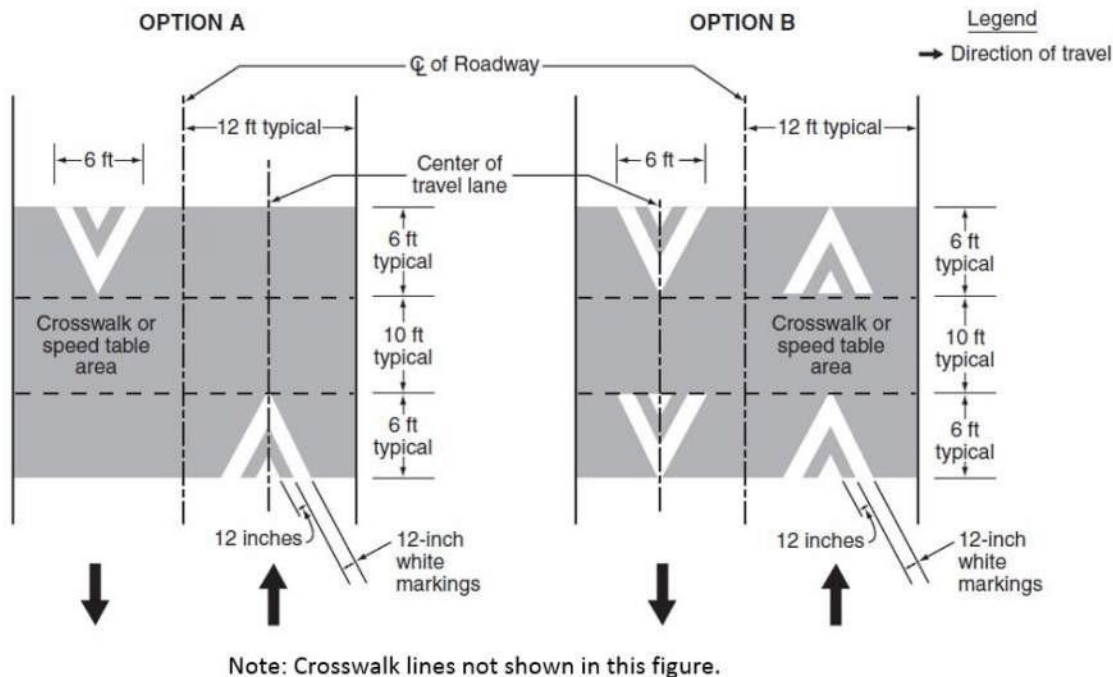

13.4.9.5 Signalized Pedestrian Crossings

Where signal warrants for pedestrian crossings are met, the installation of traffic signals should be considered. At midblock locations accessible pedestrian signals shall be provided.

Where accessible pedestrian signals are to be installed, they shall comply with all the requirements of the MUTCD.

13.4.9.6 Grade-Separated Pedestrian Crossings

In some locations, a grade-separated crossing is the only practical method for pedestrians to cross a roadway, for example across an expressway or where children must cross major arterials. When appropriately designed, grade-separated pedestrian crossings improve the mobility and safety of pedestrians.

Attributes of a grade-separated pedestrian crossings include the following (AASHTO,2004):

- The facility must be located where it is needed and will be used.
- Crossing structures must be built with adequate widths based on perceptions of safety, as well as pedestrian volumes.

- The design must be accessible for all users.
- Barriers and railings must be provided to add an increased sense of safety to the pedestrian.
- The facility must be illuminated to provide an increased level of security to the pedestrian.

Where grade-separated crossings are installed, approaches must meet grade criteria provided in Section 13.4.3.

Where the designer has a choice between a tunnel and an overpass, an overpass is often preferable. Overpasses have security advantages. Additionally, lighting is often a requirement for tunnels and may not be necessary for an overpass. Drainage may also be easier to accommodate on overpasses. Underpasses are often more difficult to construct because of utility conflicts or phasing issues. Additionally, pedestrians are more likely to use an overpass than an underpass. However, overpasses have significantly greater vertical clearance requirements. Overpasses are required to be 17 feet 6 inches above the roadway surface compared to underpasses where the roadway is required to be 10 feet above the path surface.

When considering a grade-separated pedestrian crossing, a feasibility study shall be conducted. This study would quantify current and future pedestrian use, as well as alternatives for at-grade crossings.

Contrasting crosswalk coloring is often requested in downtown areas. The use of contrasting coloring does not eliminate the requirement to mark crosswalks with white, retroreflective pavement markings.

13.4.9.7 Sidewalk Crossings of Rail Lines

Where sidewalks cross railroad tracks, appropriate crossing treatments shall be provided.

Of particular importance to individuals with mobility impairments is the interface between the rails and the sidewalk. Sidewalk surfaces should be flush with the tops of rails. Openings for wheel flanges at pedestrian crossings of freight rail track should be 3 inches maximum. Openings for wheel flanges at pedestrian crossings of non-freight rail track should be 2.5 inches maximum.

Detectable warnings should be placed on the approaches to all rail crossings unless the rail crossing is included within a roadway crossing. The detectable warning surface should be located so that the edge nearest the rail crossing is 6 feet minimum and 15 feet maximum from the centerline of the nearest rail. The rows of truncated domes in a detectable warning surface should be aligned to be parallel with the direction of wheelchair travel.

At light-rail transit (LRT) rail line crossings, pedestrian signal heads must comply with the provisions of the MUTCD.

Where a sidewalk crosses a light rail transit line, flashing-light signals (Figure 13-70) with a CROSSBUCK (R15-1) sign and an audible device should be installed at pedestrian crossings where an engineering study has determined that the sight distance is not sufficient for pedestrians and

bicyclists to complete their crossing prior to the arrival of the LRT traffic at the crossing, or where LRT speeds exceed 35 mph.

If an engineering study shows that flashing-light signals with a CROSSBUCK sign and an audible device would not provide sufficient notice of approaching light rail trains, the LOOK (R15-8) sign, pedestrian gates, or both, should be considered.

Figure 13-70 Example of Flashing -Light Signal Assembly for Pedestrian Crossings

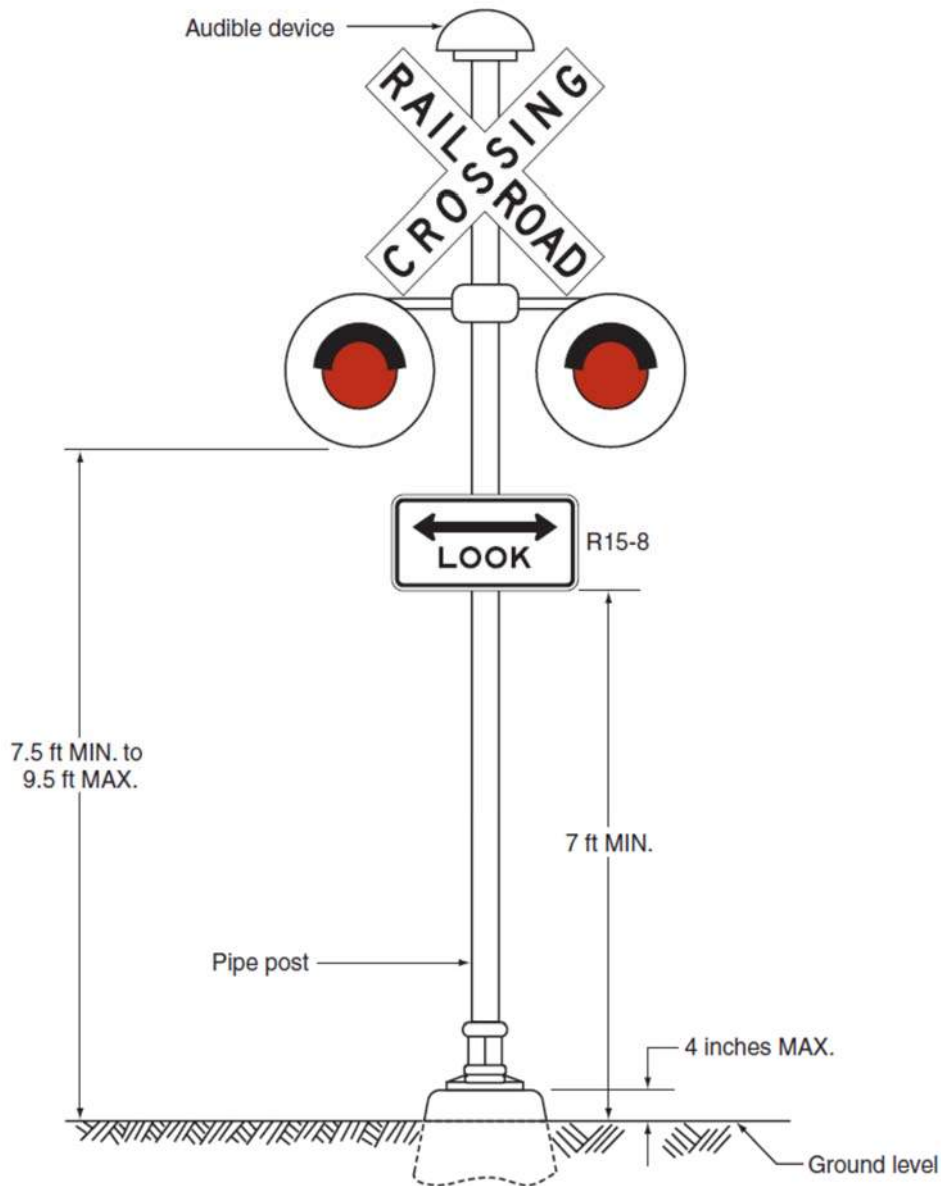

13.4.10 Other Pedestrian Considerations

13.4.10.1 Traffic Calming

The Institute of Transportation Engineers (ITE) uses the following definition for traffic calming: “*Traffic calming is the combination of mainly physical measures that reduce the negative effects of motor vehicle use, alter driver behavior to improve conditions for non-motorized street users.*” (Lockwood, 1997).

Traffic calming features are used on roadways to slow traffic speeds. Vertical and horizontal alignment and increased side friction are used to physically restrict the speeds motorists are comfortable driving. Thus, traffic calming is self-enforcing.

Traffic calming is often used in combination with lane narrowing, raised medians, landscaping, and lighting. While these additional treatments do not compel motorists to slow down, they may provide a visual cue to drive more slowly.

By reducing speeds, the number of traffic crashes is reduced and those crashes that do occur are often less severe than on streets without traffic calming. By reducing speeds, pedestrians’ perceptions of safety and comfort are improved as well.

ITE and FHWA produced the document *Traffic Calming: State of the Practice* (FHWA, 1999) for informational purposes. While it does not include recommendations on the best course of action or the preferred application of the data, it does provide an excellent resource for those considering the application of traffic calming treatments.

13.4.10.2 Pedestrian Amenities

Pedestrian amenities can provide a more pleasant walking environment and thus encourage more pedestrian activity. Pedestrian amenities can include aesthetic paving treatments, street furniture, shade trees, enhanced lighting, landscaping, informational signing, and public art. Because transit users begin and end their trips as pedestrians, amenities, particularly street furniture, and informational signing, can encourage more transit use. Prior to installing pedestrian amenities, a maintenance agreement should be executed with the local jurisdictions that will maintain those amenities.

If aesthetic paving treatments are used, they shall be firm, stable, and slip resistant. Cobbles or other treatments that create a vibratory surface for wheelchair users shall not be used within the pedestrian walkway; they may be used in border areas.

Pedestrian amenities shall be designed so that they do not reduce the pedestrian access route to less than 4 feet and shall meet all the criteria of Section 13.4.2.5.

Shade trees and landscaping should not restrict intersection sight triangles, or restrict pedestrian or motorists sight distances at midblock crossings.

13.4.10.3 Pedestrian Wayfinding

Pedestrian wayfinding provides information on walk routes to destinations and attractions. Pedestrian wayfinding can encourage pedestrian activity and transit use. Local jurisdictions should be consulted concerning the design or visual theme of pedestrian signage. The development of pedestrian routes should include the participation of local agencies and walking interest and advocacy groups.

The MUTCD does not provide specific signs to be used for pedestrian wayfinding. However, standard alphabets with a minimum text height of 2 inches should be used for pedestrian signs to ensure legibility.

13.4.10.4 On-Street Parking

On-street parking significantly improves the safety and perception of comfort for pedestrians. On-street parking provides an additional buffer between the travel lanes and the sidewalk and often results in reduced motor vehicle travel speeds, encouraging a more pedestrian-friendly environment.

In areas with on-street parking, curb extensions should be considered to restrict parking near intersections and midblock crossing locations to improve the motorist-pedestrian line of sight at the crossing. Additionally, curb extensions reduce the crossing distance and the amount of time the pedestrian is required to spend at street-level, improving their perception of comfort. Drainage patterns need to be considered during the design of curb extensions.

13.4.11 School Areas

School zones represent a particular challenge to pedestrian facility design. Children are the most unpredictable, least traffic savvy of pedestrians.

Special consideration should be given to designing pedestrian facilities near schools. Sidewalks should be located as far from the roadway as possible. In some locations, it may be advisable to channelize school children with fences or other barriers. These barriers should be designed so they do not hinder sight distance.

If midblock crossings are installed for school crossings, enhanced treatments should be considered. Roadway volume thresholds for Table 13-13, Table 13-14, and Table 13-15 should be reduced by 20%. School children shall not have to cross more than two lanes of traffic without a traffic signal. On roadways with raised pedestrian refuge islands, a four-lane divided roadway is the maximum width crossing without a traffic signal that may be provided specifically for school children.

Reduced speed zones should be considered in school zones. When using the SCHOOL SPEED LIMIT ASSEMBLY, the use of timed flashers is recommended (Figure 13-71). The use of the WHEN CHILDREN PRESENT (S4-3) plaque is not recommended.

Figure 13-71 School Speed Limit Assembly



Consideration should be given to restricting right turn on red during periods when students are walking to and from school. Use of the WHEN CHILDREN PRESENT (S4-3) plaque is not recommended. Consideration should be given to using designated times for the no right on red or using blank-out signs pre-timed to school walking periods. Designers should also consider eliminating right-turn on red all together in school zones.

Pedestrian staging areas at intersections and midblock crossings should accommodate the expected volume of students waiting to cross.

Student drop-off and pickup areas should be contained within the school site. If there is an area for street-side drop-off and pickup is permitted, it shall not require students to make an unsupervised crossing of a roadway.

13.4.12 Maintenance of Traffic

The following section is taken from the MUTCD. It includes the guidance and standard sections from the MUTCD. For support text, refer to Section 6D of the MUTCD.

13.4.12.1 Pedestrian Considerations in Temporary Traffic Control Zones

Advance notification of sidewalk closures shall be provided by the maintaining agency or contractor.

If the temporary traffic control (TTC) zone affects the movement of pedestrians, adequate pedestrian access and walkways shall be provided. If the TTC zone affects an accessible and detectable pedestrian facility, the accessibility and detectability shall be maintained along the alternate pedestrian route.

The following three items should be considered when planning for pedestrians in TTC zones:

- Pedestrians should not be led into conflicts with vehicles, equipment, and operations.
- Pedestrians should not be led into conflicts with vehicles moving through or around the worksite.

- Pedestrians should be provided with a convenient and accessible path that replicates as nearly as practical the most desirable characteristics of the existing sidewalks or footpaths.

A pedestrian route should not be severed or moved for non-construction activities such as parking for vehicles and equipment.

To accommodate the needs of pedestrians, including those with disabilities, the following considerations should be addressed when temporary pedestrian pathways in TTC zones are designed or modified:

- Provisions for continuity of accessible paths for pedestrians should be incorporated into the TTC plan.
- Access to transit stops should be maintained.
- A smooth, continuous hard surface should be provided throughout the entire length of the temporary pedestrian facility. There should be no curbs or abrupt changes in grade or terrain that could cause tripping or be a barrier to wheelchair use. The geometry and alignment of the facility should meet the applicable requirements of the ADAAG (U.S. Access Board, 2002).
- The width of the existing pedestrian facility should be provided for the temporary facility if practical.

Traffic control devices and other construction materials and features should not intrude into the usable width of the sidewalk, temporary pathway, or other pedestrian facility. When it is not possible to maintain a minimum width of 5 feet throughout the entire length of the pedestrian pathway, a 5-foot x 5-foot passing space should be provided at least every 200 feet to allow individuals in wheelchairs to pass.

Blocked routes, alternate crossings, and sign and signal information should be communicated to pedestrians with visual disabilities by providing devices such as audible information devices, accessible pedestrian signals, or barriers and channelizing devices that are detectable to the pedestrians traveling with the aid of a long cane or who have low vision. Where pedestrian traffic is detoured to a TTC signal, engineering judgment should be used to determine if pedestrian signals or accessible pedestrian signals should be considered for crossings along an alternate route.

When channelization is used to delineate a pedestrian pathway, a continuous detectable edging should be provided throughout the length of the facility such that pedestrians using a long cane can follow it. These detectable edgings should comply with the provisions of the MUTCD.

Signs and other devices mounted lower than 7 feet above the temporary pedestrian pathway should not project more than 4 inches into accessible pedestrian facilities.

Fencing should not create sight distance restrictions for road users. Fences should not be constructed of materials that would be hazardous if impacted by vehicles. Wooden railing, fencing, and similar systems placed immediately adjacent to motor vehicle traffic should not be used as substitutes for crashworthy temporary traffic barriers.

Ballast for TTC devices should be kept to the minimum amount needed and should be mounted low to prevent penetration of the vehicle windshield.

Movement by work vehicles and equipment across designated pedestrian paths should be minimized and, when necessary, should be controlled by flaggers or TTC. Staging or stopping of work vehicles or equipment along the side of pedestrian paths should be avoided, since it encourages movement of workers, equipment, and materials across the pedestrian path.

Access to the work space by workers and equipment across pedestrian walkways should be minimized because the access often creates unacceptable changes in grade, and rough or muddy terrain, and pedestrians tend to avoid these areas by attempting non-intersection crossings where no curb ramps are available.

A canopied walkway may be used to protect pedestrians from falling debris, and to provide a covered passage for pedestrians. Covered walkways should be sound construction and adequately lighted for nighttime use.

When pedestrian and vehicle paths are rerouted to a closer proximity to each other, consideration should be given to separating them by a temporary traffic barrier. If a temporary traffic barrier is used to shield pedestrians, it should be designed to accommodate the specific site conditions.

Guidance for locating and designing temporary traffic barriers can be found in Chapter 9 of AASHTO's Roadside Design Guide (AASHTO, 2011).

Short intermittent segments of temporary traffic barrier shall not be used because they nullify the containment and redirective capabilities of the temporary traffic barrier, increase the potential for serious injury both to vehicle occupants and pedestrians, and encourage the presence of blunt, leading ends. All upstream leading ends that are present shall be appropriately flared or protected with properly installed and maintained crashworthy cushions. Adjacent temporary traffic barrier segments shall be properly connected in order to provide the overall strength required for the temporary traffic barrier to perform properly.

Normal vertical curbing shall not be used as a substitute for temporary traffic barriers when temporary traffic barriers are needed.

If a significant potential exists for vehicle incursions into the pedestrian path, pedestrians should be rerouted (Figure 13-72) or temporary traffic barriers should be installed.

Tape, rope, or plastic chain strung between devices are not detectable, do not comply with the design standards in the ADAAG, and should not be used as a control for pedestrian movements (U.S. Access Board, 2002). In general, pedestrian routes should be preserved in urban and commercial suburban areas. Alternative routing should be discouraged. The highway agency in charge of the TTC zone should regularly inspect the activity area so that effective pedestrian TTC is maintained.

Figure 13-72 Pedestrian Facility Detour Sign



M4-9b

13.4.12.2 Accessibility Considerations

The extent of pedestrian needs should be determined through engineering judgment or by the individual responsible for each TTC zone situation. Adequate provisions should be made for pedestrians with disabilities.

When existing pedestrian facilities are disrupted, closed, or relocated in a TTC zone, the temporary facilities shall be detectable and include accessibility features consistent with the features present in the existing pedestrian facility. Where pedestrians with visual disabilities normally use the closed sidewalk, a barrier that is detectable by a person with a visual disability traveling with the aid of a long cane shall be placed across the full width of the closed sidewalk.

If a pushbutton is used to provide equivalent TTC information to pedestrians with visual disabilities, the pushbutton should be equipped with a locator tone to notify pedestrians with visual disabilities that a special accommodation is available, and to help them locate the pushbutton.