



Chapter 8 Intersections

8.1	Introduction	1
8.2	General Design Considerations	1
8.2.1	Characteristics of Intersections.....	1
8.2.2	Intersection Physical and Functional Areas	2
	<i>Figure 8-1 Physical and Functional Intersection Area</i>	<i>2</i>
	<i>Figure 8-2 Elements of the Functional Area of an Intersection.....</i>	<i>3</i>
8.2.3	Design Objectives	3
8.2.4	Design Considerations for Intersection User Groups.....	3
8.2.5	Intersection Capacity.....	3
8.2.6	Intersection Design Elements	4
8.2.7	Multimodal Integration	4
8.3	Types and Examples of Intersections	4
8.3.1	General Considerations	4
8.4	Alignment and Profile.....	5
8.4.1	General Considerations	5
8.4.2	Alignment	5
8.4.3	Profile.....	6
8.5	Intersection Sight Distance (Sight Triangle).....	7
8.5.1	General Considerations	7
	<i>Figure 8-3A Sight Distance at Intersections, Minimum Sight Triangle</i>	<i>8</i>
	<i>Figure 8-3B Sight Distance at Intersections, Minimum Sight Triangle</i>	<i>9</i>
8.5.2	Multimodal Integration.....	10
8.5.3	Traffic Control and Sight Distance	11
8.5.4	Effect of Skew	11
8.6	Intersection Curves.....	11
8.6.1	Roadway Widths for Turn Movements.....	11
	<i>Table 8-1 Design Widths of Pavements for Turn Movements.....</i>	<i>12</i>
8.6.1.1	Widths Outside Traveled Way	13
	<i>Table 8-2 Range of Useable Shoulder Widths or Equivalent Lateral Clearances Outside Turn Movements, Not on a Structure</i>	<i>13</i>
8.6.2	Minimum Designs for Sharpest Turns.....	13
	<i>Figure 8-4A Three-Centered Compound Curve (Symmetrical)</i>	<i>15</i>
	<i>Figure 8-4B Three-Centered Compound Curve (Symmetrical).....</i>	<i>16</i>
	<i>Figure 8-4C Three-Centered Compound Curve (Asymmetrical)</i>	<i>17</i>



8.6.2.1	Design Vehicles	18
	<i>Table 8-3 Intersection Design Vehicle</i>	<i>18</i>
8.6.2.2	Effect of Curb Radii on Turning Paths	18
8.7	Turning Lanes and Channelization	19
8.7.1	General	19
8.7.2	Channelized Right-Turn Lanes	19
8.7.3	Superelevation at Turning Roadway Ramp Terminals	19
8.7.4	Design Considerations	20
8.8	Islands	20
8.8.1	General	20
8.8.2	Channeling Islands	21
8.8.3	Divisional Islands	21
8.8.4	Refuge Islands	21
8.8.5	Island Size and Designation.....	21
8.8.6	Island Delineation.....	22
8.8.7	Approach Treatment.....	23
8.8.8	Corner Islands for Turning Roadways	23
	<i>Table 8-4 Typical Designs for Turning Roadways</i>	<i>24</i>
8.9	Design to Discourage Wrong-Way Entry	24
8.10	Superelevation at Intersections	25
8.10.1	General Design Guidelines.....	25
8.10.2	Superelevation Runoff.....	25
8.10.3	Development of Superelevation at Turning Roadway Ramp Terminals.....	25
8.11	Stopping Sight Distance at Intersections for Turning Roadways.....	25
8.11.1	General Design Guidelines.....	25
8.12	Auxiliary (Speed Change) Lanes	25
8.12.1	General Design Considerations.....	26
	<i>Figure 8-5 Information Guide to Basic Auxiliary Lane Elements.....</i>	<i>26</i>
	<i>Table 8-5 Components of Speed Change Lane Length</i>	<i>28</i>
8.12.2	Deceleration Lanes	28
	<i>Figure 8-6 Functional Area Upstream of an Intersection Illustrating Components of Deceleration Lane Length.....</i>	<i>28</i>
	<i>Table 8-6 Desirable Full Deceleration Length.....</i>	<i>29</i>
8.12.2.1	Perception-Reaction Time	29
8.12.2.2	Storage Length.....	29
	<i>Table 8-7 Storage Lengths for Auxiliary Lanes at Unsignalized Intersections</i>	<i>29</i>
	<i>Figure 8-7 (CDOT) Median Bay Taper</i>	<i>31</i>



8.12.2.3	Elements of Left-Turn Design (Lane Drop and Redirect Tapers).....	32
8.12.2.4	Taper Length.....	32
	<i>Table 8-8 Taper Length and Ratio for Parallel-Type Entrance</i>	<i>32</i>
8.12.3	Acceleration Length	32
	<i>Table 8-9 Desirable Acceleration Length from Stop Condition.....</i>	<i>32</i>
8.12.4	Speed Change Lane Width	33
8.12.5	Shoulder Width Along Speed Change Lanes Where Curbs Are Not Present	33
8.12.6	Design Treatments for Left-Turn Maneuvers	33
8.12.6.1	Guidelines for Provision and Design of Left-Turn Bypass Lanes.....	33
	<i>Figure 8-8 Speed-Change Lane Taper for Continuously Curbed Medians</i>	<i>34</i>
8.12.6.2	Median Left-Turn Lanes	35
	<i>Figure 8-9A Minimum Median Left-Turn Channelization, Four-Leg Intersection..</i>	<i>36</i>
	<i>Figure 8-9B Minimum Median Left-Turn Channelization, Tee Intersection</i>	<i>37</i>
8.12.6.3	Median Left-Turn Lane Warrants	38
8.12.6.4	Median End Treatment	38
8.12.6.5	Offset Left-Turn Lanes	39
8.12.6.6	Simultaneous Left-Turns	39
8.12.6.7	Double or Triple Left-Turn Lanes	39
8.12.6.8	Median Lane Width.....	39
	<i>Figure 8-10A 14 to 16-Foot Median Left-Turn Design.....</i>	<i>41</i>
	<i>Figure 8-10B 16 to 18-Foot Median Left-Turn Design.....</i>	<i>42</i>
	<i>Figure 8-10C Median Left-Turn Design for Median Width Greater Than 18 Feet .</i>	<i>43</i>
8.13	Median Openings.....	44
8.13.1	General Design Considerations.....	44
8.13.2	Control Radii for Minimum Turning Paths	44
8.13.3	Shape of Median End	45
8.13.4	Effect of Skew	45
8.13.5	Design Considerations for Higher Speed Left-Turns	45
	<i>Figure 8-11 Median Island Nose Detail</i>	<i>46</i>
8.14	Flush or Traversable Medians	47
	<i>Table 8-10 Lane Widths for Continuous Two-Way Left-Turn Lanes</i>	<i>47</i>
8.15	Indirect Left-Turns and U-Turns.....	48
8.15.1	General Design Considerations.....	48
8.15.2	Intersections with Jug Handle or Loop Roadways.....	48
8.15.3	Displaced Left-Turn Intersections	48
8.15.4	Wide Medians with U-Turn Crossover Roadways	48



8.15.5 Location and Design of U-Turn Median Openings 49

8.16 Right-Turn Lanes..... 49

8.16.1 General Design Considerations..... 49

8.16.2 Tapers..... 49

8.16.2.1 Taper Length..... 49

8.16.3 Storage..... 49

8.16.4 Length..... 50

8.16.5 Width..... 50

8.16.6 Shoulders 50

8.17 Intersection Design Elements with Frontage Roads 50

8.18 Traffic Control Devices 51









8.19 Bicycles at Intersections..... 51

8.20 Lighting at Intersections..... 51

8.21 Driveways 52

8.22 Railroad-Highway Grade Crossings 52

Legend

	Multimodal Application Example
	Context-Sensitive Solutions Application Example
	Performance-Based Practical Design Application Example
	Multimodal (MM)
	Context-Sensitive Solutions (CSS)
	Performance-Based Practical Design (PBPD)
	Web link for additional information
	AASHTO-Specific Information

Chapter

8



8 Intersections

8.1 Introduction

An intersection is defined as the general area where two or more roadways join or cross, including the roadway and roadside facilities for traffic movements within it.

Intersections operate with vehicles, pedestrians, and bicycles proceeding in many directions, often at the same time, creating the potential for conflicts. Managing these conflicts are the basis for most intersection design standards, criteria, and proper operating procedures.

An intersection is an important part of a transportation system because, to a great extent, the efficiency, safety, speed, cost of operation, and capacity depend on its design. Each intersection involves through or cross-traffic movements on one or more of the facilities concerned and may involve turning movements between these facilities. These movements may be handled by roundabouts, traffic signals, signing, and channelization depending on the type of intersection.

8.2 General Design Considerations

8.2.1 Characteristics of Intersections

The main objective of intersection design is to provide convenience, ease of use, and comfort to the people traversing the intersection while facilitating the efficient movement of passenger cars, buses, trucks, bicycles, and pedestrians. The design should be fitted closely to the natural transitional paths and operating characteristics of the users.

Four basic elements enter into design considerations of intersections:

- **Human factors.** decision reaction times, sight distance, distractions to the driver, pedestrian behavior, and bicyclist behaviors.

- **Traffic considerations.** Number of conflicting movements, required storage lengths, varying travel demand, roadway capacity, design hour traffic volumes, and vehicle speeds.
- **Physical elements.** Intersection skew, approach grades, context of the surroundings, availability of right of way, transit elements, and sight distance.
- **Economic factors.** Cost of improvements, planning horizon for improvements, community needs and desires, and energy consumption.

Although intersections have many common factors, each intersection is unique in regard to intersection design variables and operational characteristics.

Each facility radiating from an intersection is an intersection leg. The most common intersection has two facilities crossing each other, resulting in four legs. It is recommended that an intersection have no more than four legs.

8.2.2 Intersection Physical and Functional Areas

Intersections are defined by both the physical and functional areas, as shown in Figure 8-1. The physical intersection area traditionally extends from point of control perpendicular across the roadway. The functional intersection area extends both upstream and downstream of the physical intersection area and includes speed change lanes and their tapers.

Figure 8-1 Physical and Functional Intersection Area

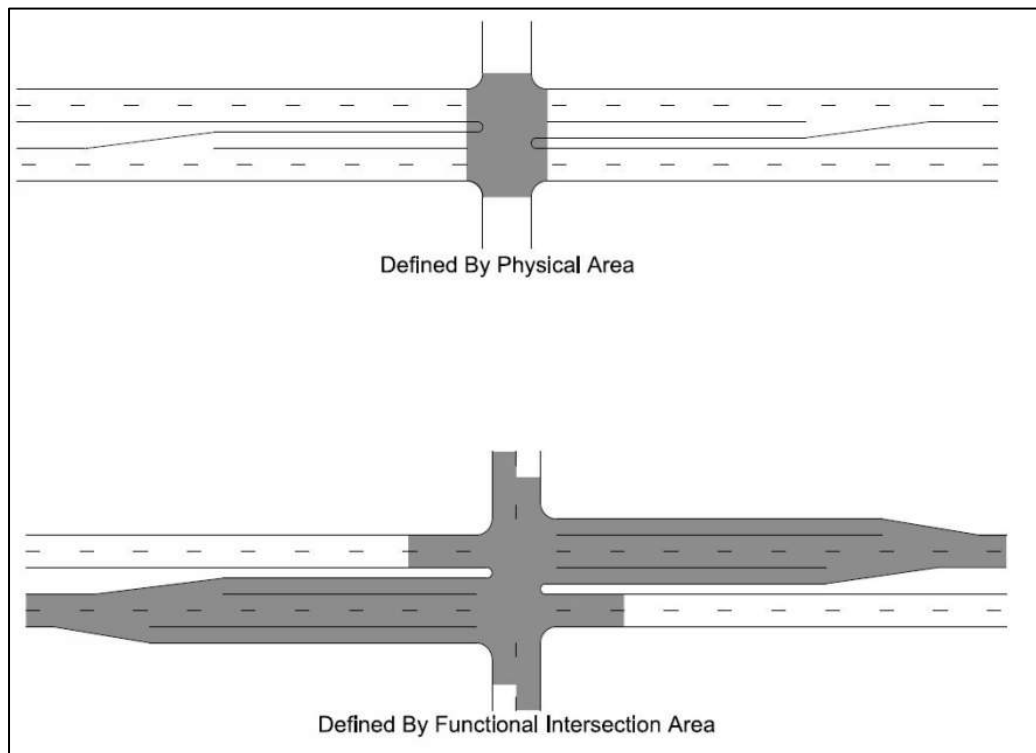

The functional area of the approach to an intersection or access point includes the perception-reaction decision distance, deceleration distance that includes maneuvering, and storage distance. Elements of the functional area are shown in Figure 8-2.

Figure 8-2 Elements of the Functional Area of an Intersection

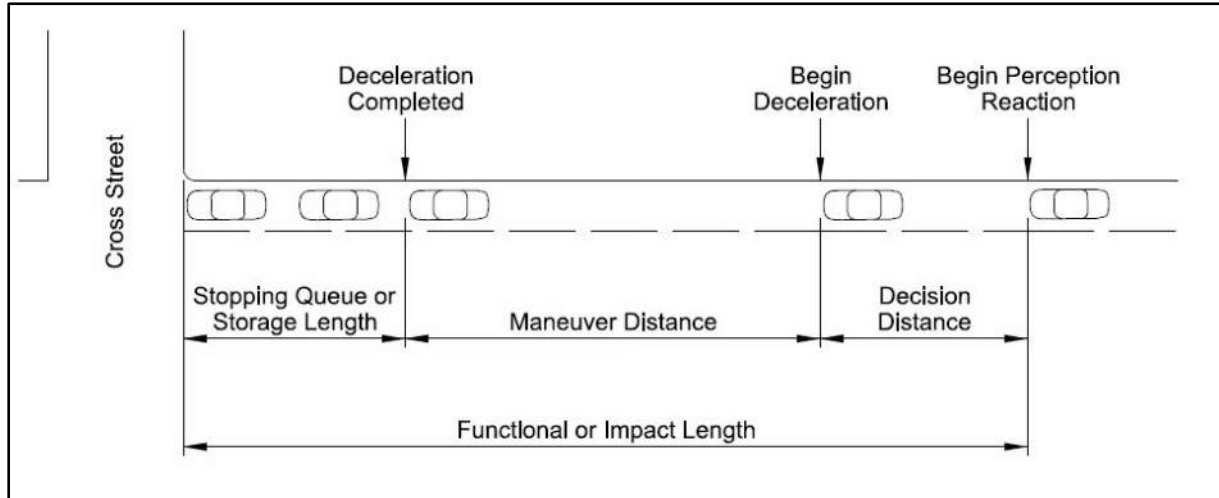

8.2.3 Design Objectives



When considering the intersection design and specific elements such as length of auxiliary lanes, the designer should have the intersection traffic counts completed and modeled to replicate the traffic movements through a series of intersection configurations to determine the optimal design solution and auxiliary lane lengths for the intersection. This helps to optimize the intersection and avoid over designing an intersection.

8.2.4 Design Considerations for Intersection User Groups



Information gained from the local agency or community may help the designer to understand the common uses at and around an intersection. The uses that can help define the context the intersection must support include transit stops, schools, bicycle and pedestrian movements, and complex multimodal settings in urban areas. Taking these uses into consideration will help determine the various intersection elements that can best support the context.

8.2.5 Intersection Capacity

Capacity and level of service analysis is one of the most important considerations in the design of intersections. While highway level of service is typically defined by density, delay typically defines intersection level of service. Table 9-1 in Chapter 9 of the American Association of State Highway

and Transportation Officials (AASHTO) A Policy on Geometric Design of Highways and Streets (the Green Book) (2018 AASHTO GDHS) (AASHTO, 2018) describes intersection level of service.

Optimum capacities can be obtained when at-grade intersections include auxiliary lanes, proper use of channelization, and traffic control devices. For more complete coverage of capacity of intersections, including procedures for making capacity computations, refer to Chapter 16 of the *Highway Capacity Manual* (TRB, 2022).

8.2.6 Intersection Design Elements

There are many variables and elements that influence the design of an intersection. This is what makes each intersection location unique. Below is a listing of some key elements to consider. Additional information can be found in Chapter 9, Section 9.2.6, of the 2018 AASHTO GDHS.

- Alignment and profile.
- Intersection sight distance.
- Pedestrian, bicycle, and transit activity.
- Access spacing along the roadway.
- Auxiliary lanes.
- Intersection type.

8.2.7 Multimodal Integration

In all context classifications, intersection design should reduce conflicts between bicyclists, pedestrians, and motorists. This is typically achieved by increasing visibility of all roadway users and designating facilities to create awareness of all modes of travel. Designers should consider the needs of each mode and how to best accommodate those needs to achieve overall system goals. For example, when thinking about pedestrians, it is a best practice to design the shortest crossing distance, to provide lighting, and to utilize directional ramps. For bicyclists, the design should enable them to bypass vehicle queues, so the bicyclist can clear the intersection as quickly as possible. For transit, bus stops are generally preferred on the far side of an intersection and may include utilizing right-turn lanes as bypass lanes. Each intersection is unique, so designers should utilize the CSS and PBPD frameworks to understand the needs and make data-driven decisions when determining how to best integrate multimodal elements.

8.3 Types and Examples of Intersections

8.3.1 General Considerations

The type of at-grade intersections is determined primarily by the number of intersecting legs, the topography, the traffic patterns, and the desired type of operation. Intersection Control Evaluation (ICE) should be used as a method to help screen intersection types for projects. Basic intersection types are the following:

- T-intersection (with multiple variations of angular approach).
- Four-leg intersection.

- Multileg intersection.
- Roundabout (refer to Chapter 9 of this Guide).
- Grade separations and interchanges (refer to Chapter 10 of this Guide).

Each intersection type can vary greatly in scope, shape, and degree of channelization. To arrive at a suitable geometric plan for a specific intersection type, the designer applies the context described in Chapter 1, the facility type described in Chapter 3, 4, or 5, and the design controls and criteria covered in Chapter 2; and the intersection design elements described in Chapter 6, Chapter 7, and this chapter.



Use this link to access the Colorado Intersection Control Assessment Tool (ICAT):
<https://www.codot.gov/programs/maintenance-operations/tsmo-evaluation>



Use this link to access the FHWA Intersection Control Evaluation:
<https://highways.dot.gov/safety/intersection-safety/ice>

Each at-grade intersection type is discussed in Chapter 9 of the 2018 AASHTO GDHS, and likely variations of each are demonstrated. It is not practical to cover all possible variations, but the types demonstrated are sufficient to cover the general application of at-grade intersection design. Many other variations of types and treatment may be found in the NCHRP Report 279, Intersection Channelization Design Guide (NCHRP, 1985), which shows examples in detail that are not included in this Guide.

For roundabout design, refer to Chapter 9 of this Guide.

8.4 Alignment and Profile

8.4.1 General Considerations

Horizontal and vertical alignment and profile features affect driver behavior on the approach to and at the intersection. The horizontal and vertical alignment of the intersecting roads should permit users to readily discern and perform the maneuvers necessary to pass through the intersections safely with minimum interference with other users.

As a rule, alignment and grade are subject to greater control at or near intersecting roads than on a roadway segment. Alignment and grade at or near the intersection must produce traffic lanes that are clearly visible to the operators, plainly understandable for any desired direction of travel, free from unexpected hazards, and consistent with the portions of the roadway just traveled.

8.4.2 Alignment

Driver expectancy, vehicle operations, and vehicle conflicts are affected by the approach angle of an intersection. Approach angles of 75 to 90 degrees are generally considered desirable. Approach



angles less than 75 degrees should be avoided on new construction. Existing intersections with an acute skew that is less than 75 degrees ideally should have the skew angle corrected. If improving the skew is not possible then alternative measures should be considered such as modifying the intersection to right in right out access on the skewed leg.

Angles less than 60 degrees are considered acute or skewed angles and are undesirable because they pose many safety issues, particularly an increased potential for broadside and approach turn crashes. Acute angles tend to have restricted line of sight at the corner and drivers can't see other vehicles approaching the intersection. When a truck turns on an obtuse angle, the driver has blind areas on the right of the vehicle. It can be difficult for a vehicle to make the acute turn and increase the time needed to pass through the intersection, which increases the exposure time of the vehicles crossing the main traffic flow and the potential for crashes. For these reasons, a wider turning area may also be required.

The designer should look at the intersection and surroundings to identify elements that may impact the safe operation of the skewed intersection and incorporate design and control features to mitigate them. These may include more positive traffic control (all stop, traffic signals) and/or geometric improvements, such as greater corner sight distance.

Geometric countermeasures to reduce or eliminate the skew of an intersection (such as greater corner sight distance), although expensive, are generally the best solution for skewed-angle intersections. Design for reconstruction of an intersection should take into consideration traffic patterns at the intersection, as well as constraints, such as available right of way. Chapter 9 of the 2018 AASHTO GDHS includes successful examples of how to realign roads intersecting at acute angles. Refer to Figure 9-22 in the 2018 AASHTO GDHS for an example of an acute angle intersection and how the sight distance of a vehicle maybe restricted by roadside objects or buildings to see an approaching vehicle on the cross street.

Special care should be taken in designing intersections near horizontal curves. Tracking the curve takes up much of the driver's focus, leaving less attention for avoiding potential conflicts. An effective countermeasure for signalized intersections is to provide advance "signal ahead" signing with flashing beacons to alert the driver to the upcoming curve and intersection.

8.4.3 Profile

In general, grades at intersecting roads should be as flat as possible to accommodate storage platforms and to maintain adequate sight distance. In areas prone to winter snow and icing conditions, there is a need for flat storage areas. Grades at intersections where these conditions exist should not exceed more than 2% so cars can more safely stop and accelerate from a stop.

Most drivers are unable to anticipate the increase or decrease in stopping or accelerating distances required on steep grades. It is not uncommon for the driver's decisions and reactions to be in error when judging stopping and acceleration distances on steep grades. On grades steeper than 3%, grade adjustment factors need to be applied to other design elements to produce conditions equivalent to those on level highways. Regarding approaches to intersections the designer should attempt to flatten the grades approaching the intersection to 3% or less.



The profile grade and cross sections (cross slope) on the approach legs to an intersection should be adjusted in advance of the intersection to provide a smooth transition with the cross street and to facilitate proper drainage. Generally, 20 feet or more may be required. For highway intersections, the grade line and cross section (cross slope) of the highway is carried through the intersection, and the cross road or street is adjusted to match the highway profile and cross slope.

Changes from one cross slope to another should be gradual. Intersections where a minor road crosses a multilane divided highway with a narrow median and superelevated curve should be avoided whenever possible because of the difficulty in adjusting approach grades to match the superelevation to provide a suitable crossing.

Superelevated roadways tend to be high-speed roadways (greater than 45 mph posted speed). The decision to install or retain an intersection within a superelevated section should be carefully discussed with the Traffic Engineer. Solutions for an intersection on a superelevated section include modifying it to eliminate all left-turn movements (i.e., a right-in/right-out only intersection), raising the minor street profile grade to the same elevation of the superelevated roadway with a flat storage area for visibility and driver decision making, and lowering or removing the superelevation to improve the intersection approach profile grade lines.

8.5 Intersection Sight Distance (Sight Triangle)

8.5.1 General Considerations

Intersection sight distance (ISD) is a critical intersection design safety topic. Sufficient sight distances contribute to the safety of vehicles approaching an uncontrolled intersection. A safe sight distance is directly related to vehicle approach speeds and to the distances traversed during perception, reaction time, and braking.

A well-designed intersection will have an unobstructed sight distance along all legs of the intersection and across its corners of sufficient length that a driver has enough decision and reaction time to avoid a potential collision by accelerating, slowing down, or stopping.

Figures 8-3A and 8-3B illustrate these maneuvers, as well as the sight distances that must be provided for vehicles approaching on a major highway from either direction. Distance “b” is the length of roadway traveled by the respective vehicle on a major roadway during the time required for the stopped vehicle to depart from its stopped position and either cross the intersection or to turn onto the major roadway.



Figure 8-3A Sight Distance at Intersections, Minimum Sight Triangle

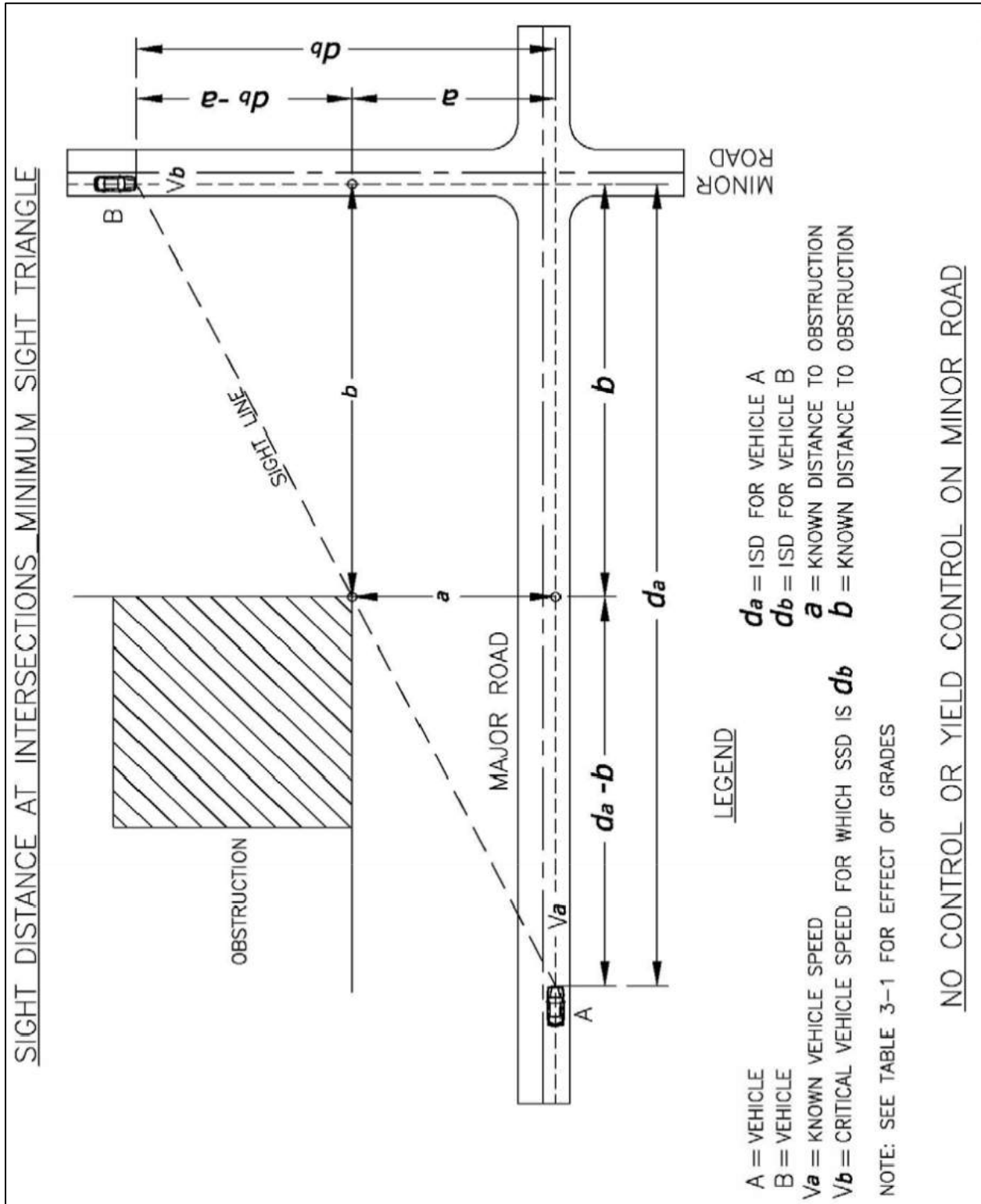
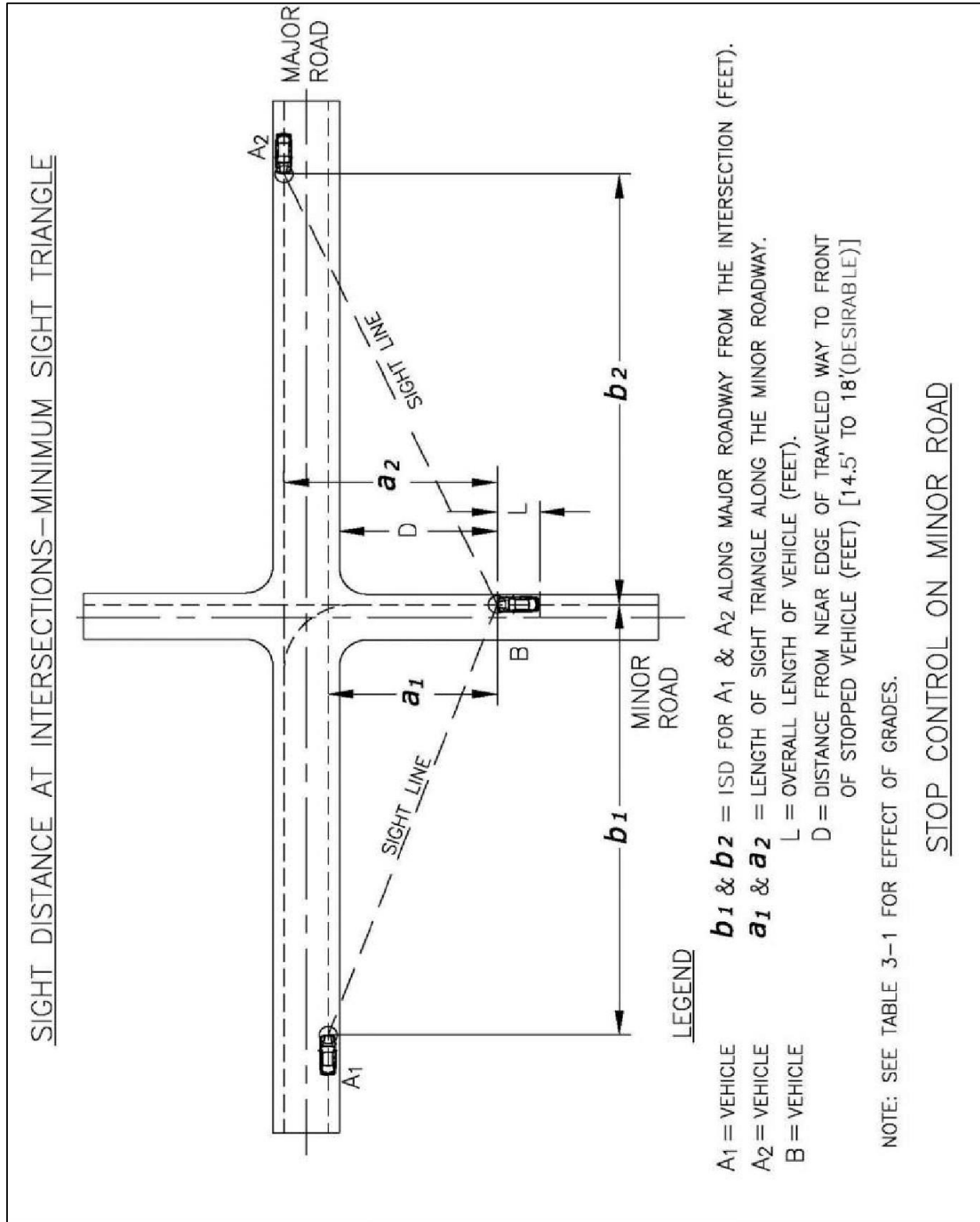

Figure 8-3B Sight Distance at Intersections, Minimum Sight Triangle





In the more urban environments in context classifications C4, C5, and C6, it is unlikely that the preferred sight distances will be unobstructed by objects, such as buildings and parked cars, so the designer can use the PBPB framework to adjust many factors, such as approach speed or lane width, to achieve an acceptable condition.

Sight triangles are potentially impeded by landscaping (trees or tall brush), roadside amenities (signs, etc.), or other objects that can block a driver's line of sight to approaching vehicles. Discussions with the local agency about roadside enhancements can identify what options are available to ensure the sight triangle line of sight is maintained. For example, low-height (3 feet or less) shrubs and plants will not impair a driver's ability to see approaching vehicles.



To improve the visibility of bicyclists at urban intersections, the designer can consider bike boxes, dashed bike lanes, and advanced/protected signal phases. Refer to Chapter 13 of this Guide and the NACTO Urban Bikeway Design Guide (NACTO, 2014) for bicycle treatments.



Directional curb ramps help motorists understand which leg of the intersection a pedestrian intends to cross. Leading pedestrian intervals in the signal phasing can improve visibility and reduce conflicts with turning vehicles.

8.5.2 Multimodal Integration

Intersections serve many users, and the designer needs to be prepared to help support all modal types that use the intersection. Below are several suggestions and examples of ways the designer can support pedestrians, bicycles, and transit in intersection design.

- Considerations for pedestrians - with and without crosswalks:
 - Adequate sight triangle line of sight.
 - Rapid rectangular flashing beacon (RRFB) at stop or uncontrolled intersections.
 - Advanced walk signal phase for pedestrians at signalized intersections.
- Considerations for bicyclists - with and without dedicated bike lanes:
 - "Bicycle ahead" signing at crossings with frequent bicycle activity.
 - Bike boxes and bike markings at signalized intersections.
 - Advanced or protected movement signal phase for bicyclists at signalized intersections.
- Considerations for transit - bus stops, dedicated bus lanes, no dedicated bus lane, rail cars:

- Locate bus stops downstream from the intersection to improve sight triangle visibility for the pedestrian and motorists at the intersection and to help the bus merge back into the travel lanes more easily.
- Pull-outs for buses to improve intersection visibility for motorists.

8.5.3 Traffic Control and Sight Distance

The recommended dimensions of a sight triangle vary with the type of traffic control used at an intersection because different types of control impose different legal constraints on drivers and, therefore, result in different driver behavior. Procedures to determine sight distances, depending on the type of traffic control, are presented in Chapter 9 of the 2018 AASHTO GDHS for each of the cases below:

- Case A - Intersections with no control (not used on State Highways).
- Case B - Intersections with stop control on the minor road.
 - Case B1 - Left turn from the minor road.
 - Case B2 - Right turn from the minor road. **Note: Case B2 applies to signalized intersections, including ramp terminals where right-turn on red is permitted.**
 - Case B3 - Crossing maneuver from the minor road.
- Case C - Intersections with yield control on the minor road.
 - Case C1 - Crossing maneuver from the minor road.
 - Case C2 - Left- and right-turn maneuvers.
- Case D - Intersections with traffic signal control.
- Case E - Intersections with all-way stop control.
- Case F - Left turns from the major road.

8.5.4 Effect of Skew

Refer to Section 9.5.4 of the 2018 AASHTO GDHS.

8.6 Intersection Curves

8.6.1 Roadway Widths for Turn Movements

Note: The terms “turning movements” and “turn movements” used in this Guide are also referred to as “turning roadways” in the 2018 AASHTO GDHS.

The desired roadway and pavement widths for turn movements at an intersection are governed by the level of turn movement traffic volumes, the types of vehicles to be accommodated, and the geometric pattern of the intersection (one-way or two-way operation). Widths determined for turn movements are also applied to the roadway widths within an intersection. In addition, the turning radii and the pavement cross slopes are functions of design speed and types of vehicles to be accommodated.

Pavement widths for turn movements are classified as shown in Table 8-1.



Table 8-1 Design Widths of Pavements for Turn Movements

	Case I One-Lane, One-Way Operation - No Provision for Passing a Stalled Vehicle			Case II One-Lane, One-Way Operation - With Provision for Passing a Stalled Vehicle			Case III Two-Lane Operation - Either One-Way or Two- Way		
--									
--	Pavement Width (ft) for Design Traffic Conditions								
Radius on Inner Edge of Pavement (ft)	A	B	C	A	B	C	A	B	C
50	18	16	15	20	26	30	31	36	45
75	18	17	16	19	23	27	29	33	38
100	23	20	18	18	22	25	28	31	35
150	14	13	13	18	21	23	26	29	32
200	15	15	15	17	20	22	26	28	30
300	17	16	15	17	20	22	25	28	29
400	13	12	12	17	19	21	25	27	28
500	15	15	14	17	19	21	25	27	28
Tangent	15	15	14	17	18	20	24	26	26
Width Modification Regarding Edge Treatment									
No stabilized shoulder	None			None			None		
Sloping Curb	None			None			None		
Vertical curb	Add 1 foot			None			Add 1 foot		
1 Side	Add 1 foot			None			Add 1 foot		
2 Sides	Add 2 feet			Add 1 foot			Add 2 feet		
Stabilized shoulder, one or both sides	Lane width for conditions B and C may be reduced to 12 feet where shoulder is 4 feet or wider.			Deduct shoulder width; minimum pavement width as under Case I.			Deduct 2 feet where shoulder is 4 feet or wider.		

A = Predominantly P vehicles, but some consideration for SU trucks

B = Sufficient SU vehicles to govern design, but some consideration for semi-trailer combination trucks

C = Sufficient bus and combination-trucks to govern design



8.6.1.1 Widths Outside Traveled Way

The roadway width for a turning movement, as distinct from pavement width, includes the shoulders or equivalent lateral clearance outside the edges of pavement.

Table 8-2 is a summary of the range of design values for pavements outside of the traveled way. The widths shown are for usable shoulders. On roadways without curbs or those with sloping curbs, the adjacent shoulder should be of the same type and section as that on the approach roadway. Where there are roadside barriers, the width indicated should be measured to the face of the barrier, and the graded width should be about 2 feet greater.

Wheel tracking for turn movements by large vehicles, buses, or vehicle-trailer combinations should be checked with the appropriate software.

Table 8-2 Range of Useable Shoulder Widths or Equivalent Lateral Clearances Outside Turn Movements, Not on a Structure

Turning Roadway Condition	Shoulder Width or Lateral Clearance Outside of Traveled Way Edge (ft)	
	Left	Right
Short length, usually within channelized intersection	2 to 4	2 to 4
Intermediate to long length, or in cut or on fill	4 to 10	6 to 12

Note: All dimensions should be increased where necessary for sight distance.

8.6.2 Minimum Designs for Sharpest Turns

After the lane width has been determined, site conditions, along with traffic and island requirements, govern the curve selection. Generally, a three-centered curve is used to minimize the paved area and right of way requirements. The curve should be suitable for the anticipated truck traffic; the curve design for a commercial vehicle (SU) is considered the desirable minimum.

Curbs along the edge of pavement of sharp intersection curves restrict vehicles making the turn, and a design vehicle making its minimum turn will need to be maneuvered carefully to avoid scraping or jumping the curb. For this reason, when there are curbs, it is desirable to use somewhat flatter curves than those in minimum edge-of-pavement designs.

In the design of the edge of the pavement for the minimum path of a given design vehicle (refer to Figure 9-23 through 9-30 of the 2018 AASHTO GDHS), it is assumed that the vehicle is properly positioned within the traffic lane at the beginning and end of the turn, i.e., 2 feet from the edge of pavement on the tangents approaching and leaving the intersection curve. Curve designs for edge of pavement conforming to this assumption for passenger vehicles, single-unit trucks and buses, and semitrailer combinations are shown in Chapter 9 of the 2018 AASHTO GDHS. The paths indicated, which are slightly greater than the minimum paths of nearly all design vehicles in each class, are the minimums attainable at speeds less than 10 mph. In each case, these widths must

be increased to address turn movements of vehicles operating at over 10 mph. The wheel path should be 2 feet or more away from the edge of pavement throughout most of the turn, and at no point less than 1 foot.

Although not shown separately in the figures in the 2018 AASHTO GDHS, these edge-of-pavement designs also apply to left-turn layouts, such as a left turn to leave a divided highway at a very low speed. The designer should analyze the likely paths and encroachments that result when a turn is made by a large vehicle, for example a truck swinging wide into adjacent traffic lanes, and provide a design that minimizes traffic disruption.

The design should be modified where alignment conditions provide the assumed positioning, such as curvature prior to or at the end of the turn. Superimposing the appropriate design-vehicle turning template is the most expeditious way to customize a design for special conditions. However, the designer should not rely solely on a turning template for the layout. The traffic engineer and the local maintenance staff can provide insight into whether existing turning movements are difficult or track differently than the template models. This can help the designer solve a specific problem with a solution that the template may not account for.

Figures and data for three-centered curves (symmetrical and asymmetrical) are shown in Figures 8-4A, 8-4B, and 8-4C, and Table 9-16 in the 2018 AASHTO GDHS.

Figure 8-4A Three-Centered Compound Curve (Symmetrical)

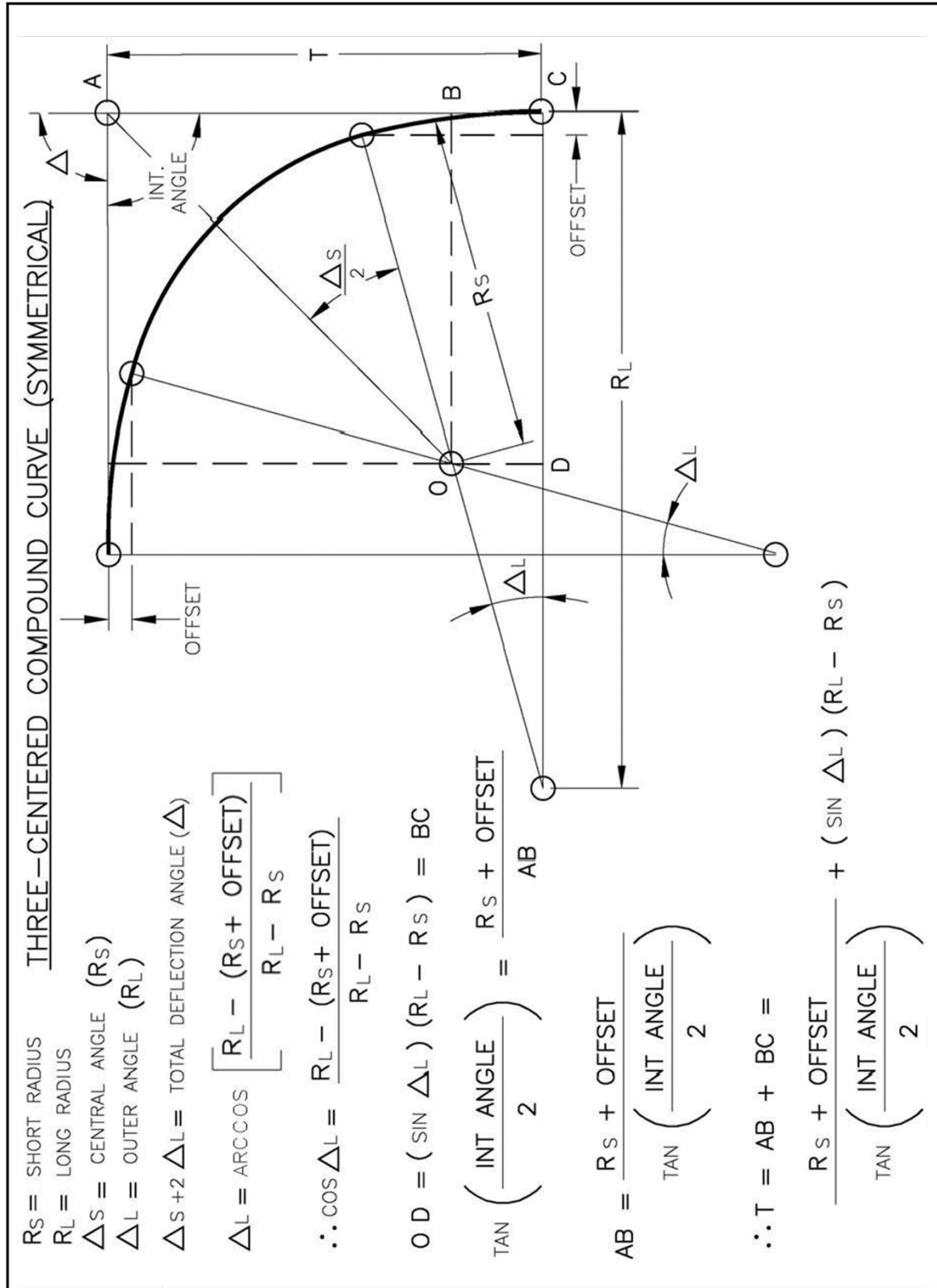

Figure 8-4B Three-Centered Compound Curve (Symmetrical)

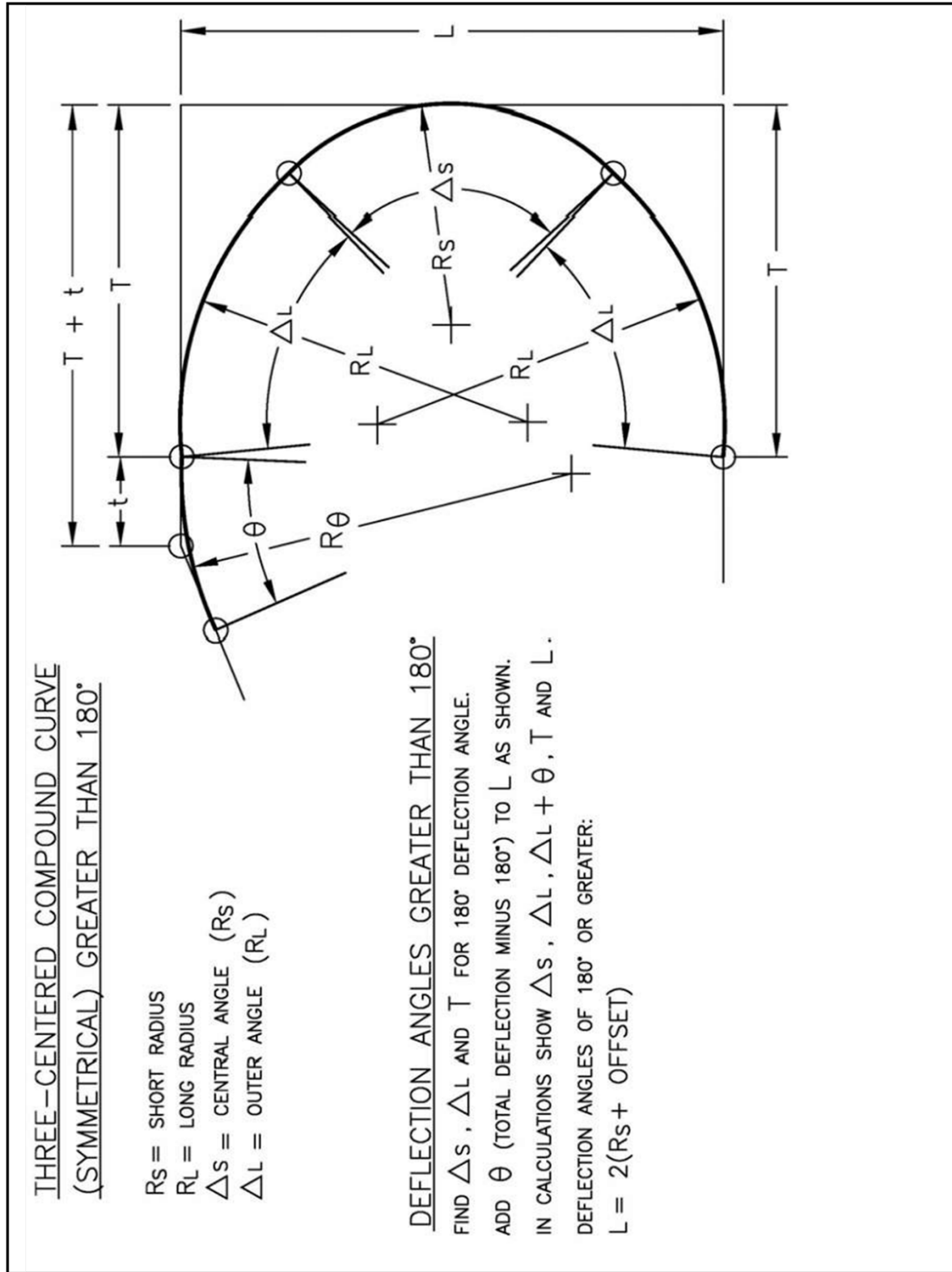
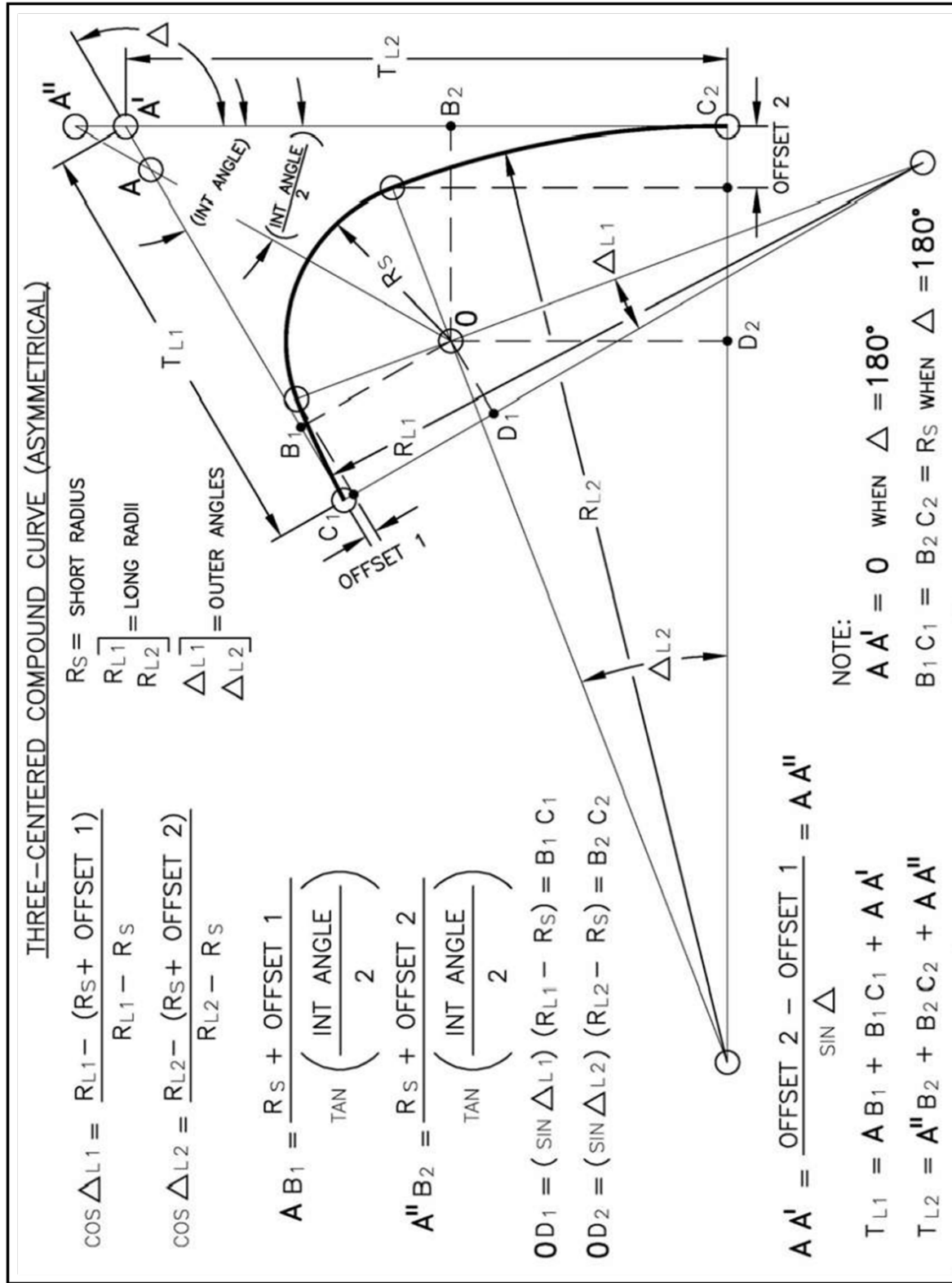

Figure 8-4C Three-Centered Compound Curve (Asymmetrical)



8.6.2.1 Design Vehicles

The classes of design vehicles and their characteristics are provided in Chapter 2 of this Guide. For a thorough discussion and dimensions of the design vehicles, refer to Chapter 2 of the 2018 AASHTO GDHS.

The primary use of the design vehicle in intersection design is to determine the turning radius requirements for each leg of the intersection. A different design vehicle can be used for each leg of the intersection. It is recommended to select a design vehicle that is the largest vehicle that normally uses the intersection or intersection leg. Table 8-3 shows the minimum design vehicle to use for different intersection types. If there are reasons to use a smaller design vehicle (such as in pedestrian priority zones or transit corridors), a traffic analysis showing that the proposed vehicle is appropriate is recommended. The traffic analysis could be as simple as a discussion and concurrence from the traffic engineer and a note to the project file on the decision made.

Table 8-3 Intersection Design Vehicle

Intersection Type	Design Vehicle
Junction of Major Truck Routes	WB-67
Junction of State Highways	WB-67
Ramp Terminals	WB-67
Other Rural	WB-67
Industrial	WB-40
Commercial	SU ^{1, 2}
Residential	SU ^{1, 2}

1. To accommodate pedestrians, the P vehicle may be used as the design vehicle if justification with a traffic analysis is documented.
2. When the intersection is on a transit or school bus route, use the BUS design vehicle as a minimum.

To minimize the disruption to other traffic, the intersection design should allow the design vehicles to make each turning movement without encroaching on curbs, opposing lanes, or same-direction lanes at the entrance leg.

Each intersection curve should be designed so the largest vehicle that is anticipated to use the intersection can make the turn without leaving the paved shoulders or encroaching on a sidewalk. At all state highway to state highway junctions, the largest design vehicle should be determined by the surrounding context that the facility supports, and purpose and need of the project.

8.6.2.2 Effect of Curb Radii on Turning Paths

The widths for various angles of intersecting streets occupied by turning vehicles are shown in Table 9-17 and Figure 9-33 of the 2018 AASHTO GDHS. When the angles increase, the streets must be very wide, or a very large curb radius must be used. For this reason, three-centered curves are preferred for this type of situation.



Corner radii at intersections on arterial streets should satisfy the requirements of the drivers using them to the extent practical. The design should consider the amount of right of way available, the approach angle of the intersection, presence of pedestrians, roadway width and number of lanes on the intersecting streets. Other considerations include the functional classifications and uses of the minor street, such as parking, transit, bicycles, pedestrians, ADA, etc.

8.7 Turning Lanes and Channelization

8.7.1 General

A safe and effective turn lane that does not hinder a driver's expectations and movement through the intersection is designed with the proper curvature, turning widths, and shoulders. Effective channelization can enhance and improve the safety of turn lanes by keeping the driver in the appropriate lane to avoid sideswipe collisions with other vehicles. The channelization can also provide refuge for pedestrians where multiple conflict points and vehicle movements are occurring.

Channelization is the separation or regulation of conflicting traffic movements into delineated paths of travel using physical traffic islands or pavement markings that facilitate the safe and orderly movements of vehicles, bicycles, and pedestrians.

8.7.2 Channelized Right-Turn Lanes

The designs given in Table 9-17 of the 2018 AASHTO GDHS relating to minimum edge-of-pavement designs for turns at intersections are those suggested to fit the sharpest turns of the different design vehicles at oblique-angle intersections. For angles of turn less than 90 degrees, trucks also can turn on an inner edge of pavement designed for passenger vehicles with even less encroachment than that for the 90-degree turns. For turning angles of more than 90 degrees, the minimum design must be adjusted to ensure that all turning trucks remain within two lanes of pavement on each roadway.

8.7.3 Superelevation at Turning Roadway Ramp Terminals

Superelevation commensurate with curvature and speed seldom is practical at ramp terminals where:

- A flat intersection curve results in little more than a widening of the through traffic pavement.
- It is desirable to retain the cross slope of the through pavement.
- There is a practical limit to the difference between the cross slope on the through pavement and that on the intersection curve.

8.7.4 Design Considerations

- Literature review of the safety and operation aspects of intersections
- Survey of design practices of state, cities, and counties
- Collection of example intersection designs
- Field studies of intersections
- Development of design guidelines for channelizing

8.8 Islands

8.8.1 General

An island is a defined area between traffic lanes that controls vehicle movements. Within an intersection, a median or an outer separation is considered an island. An island may range from an area delineated by a curb to a pavement area marked by paint. At some intersections, both curbed and painted islands may be desirable.

Multiple intersections with similar intersection needs may occur in a given project. It is desirable to have a common geometric design for each intersection within the project limits to the extent practicable to enhance driver expectancy. For the various types and shapes of islands, refer to Figure 9-36 of the 2018 AASHTO GDHS.

Islands generally are included in intersection design (channelization) for one or more of the following purposes:

- Separation of conflicts.
- Control of angle of conflict.
- Reduction in excessive pavement areas.
- Regulation of traffic and indication of proper use of intersection.
- Arrangements to favor a predominant turning movement.
- Protection of pedestrians (including ADA requirements).
- Protection and storage of turning and crossing vehicles.
- Location of traffic control devices.
- Access control.

Islands generally are either elongated or triangular in shape and are situated in areas normally unused as vehicle paths. Their sizes and shapes vary materially, and there are variations for multiple and acute-angle intersections. The dimensions depend on the particular intersection design. Islands should be located and designed to offer little hazard to vehicles, be relatively inexpensive to build and maintain, and occupy a minimum of roadway space, yet be commanding enough that motorists will not drive over them.

Painted, flush medians and islands may be preferred to curbed medians under certain conditions, including the following:

- In lightly developed areas.
- At intersections where approach speeds are relatively high.
- Where there is little pedestrian traffic.
- Where fixed-source lighting is not provided.
- Where signals, signs, or lighting standards are not needed on the median or island.

All pavement markings shall be reflectorized.

8.8.2 Channeling Islands



Raised channelizing islands are effective pedestrian accommodations to shorten the crossing distance, improve visibility, and reduce vehicular speed where pedestrians are entering the roadway. Refer to Chapters 12 and 14 of the Guide and the NACTO Urban Bikeway Design Guide (NACTO, 2014).

8.8.3 Divisional Islands

Divisional islands are generally used to separate opposing directions of travel on a roadway. These islands can be narrow or wide, but the minimum width of the island shall be at least 1 foot wider than the largest sign that will be placed in the island to avoid vehicle strikes from large vehicles passing by.

8.8.4 Refuge Islands



Refuge islands are raised medians that are wide enough to meet ADA requirements. They decrease the crossing distance for pedestrians and provide increased comfort at large intersections by delineating opposing traffic. Refer to Chapter 12 and Chapter 14 of the Guide and NACTO Urban Bikeway Design Guide (NACTO, 2014).

8.8.5 Island Size and Designation

Islands should be sufficiently large to command attention. The preferred dimension for a curbed island is 100 square feet or larger. In an urban setting, the smallest curbed island that should be considered is one that is approximately 50 square feet; the smallest curbed island in a rural setting is 75 square feet.

Elongated or divisional islands should be no less than 4 feet wide to accommodate sign installations, and no less than 20 to 25 feet long. Triangular islands should be no less than 12 feet long to a side, and preferably 15 feet or longer on a side after rounding of corners. Details of triangular curbed islands and their size designation are shown in Chapter 9, Section 9.6.3, of the 2018 AASHTO GDHS.

In general, introducing curbed divisional islands at isolated intersections on high-speed highways is undesirable unless special attention is directed to providing high visibility for the islands. Options for high visibility may include the addition of object markers at the leading edge of the curbed divisional island and the installation of vertical reflective delineation along the length of the divisional island.

Curbed divisional islands introduced at isolated intersections on high-speed highways should be at least 4 feet wide and 100 feet long and preferably several hundred feet in length.

8.8.6 Island Delineation

An island can be delineated or outlined by a variety of treatments, depending on its size, location, and function, and whether it is in an urban area or a rural area.

In a physical sense, islands can be divided into three groups:

- Raised islands outlined by curbs or barriers.
- Islands delineated by pavement markings placed on all paved areas. Buttons and raised (jiggle) bars are not used on Colorado facilities because of snow removal operations.
- Non-paved areas formed by the pavement edges, possibly supplemented by delineators on posts or other guideposts, or a mounded earth treatment beyond and adjacent to the pavement edges.

Delineation of a small, curbed island is primarily addressed by curbs. A large, curbed island may be sufficiently delineated by color and texture contrast of vegetative cover, mounded earth, shrubs, guard posts, signs, or any combination of these.

In rural areas, an island curb should nearly always be a sloping type, except where there is a definite need for a vertical curb, for example at structures or pedestrian crossings. In special cases, a vertical curb is suitable, commonly no more than 6 inches high. A vertical or sloping curb could be appropriate in urban areas, depending on the context of the roadway. A high-visibility curb is advantageous at critical locations or on islands and roadway forks approached by high-speed traffic.

A curbed island is sometimes difficult to see at night because of the glare from oncoming headlights or from distant luminaires or roadside businesses. Therefore, where a curbed island is used, the intersection should have fixed-source lighting or appropriate reflectorized delineation.

Delineation and warning devices are especially pertinent at approach ends of a median curbed island, which is usually in a direct line with approaching traffic. In rural areas, the approach should consist of a gradually widening center stripe. Although not as frequently obtainable, this approach should be strived for in urban areas also. Preferably, it should gradually change to a raised marking of color and texture contrasting with that of the traffic lanes. This section should be as long as practicable.

8.8.7 Approach Treatment

The outline of a curbed island is determined by the edge of through traffic lanes and turning roadways, with lateral clearance to the curbed island sides. The points at the intersections of the curbed island are rounded or beveled for visibility and construction simplicity. The amount that a curbed island is offset from the through traffic lane is influenced by the type of edge treatment and other factors, such as island contrast, length of taper or auxiliary pavement preceding the curbed island, and traffic speed. An island curb is introduced rather suddenly and should be offset from the edge of through traffic lanes even if it is sloping. A sloping curb at an island need not be offset from the edge of a turning roadway, except to reduce its vulnerability. A vertical curb should be offset from the edges of through and turning roadway pavements.

Snowplow-friendly curbed island approaches should be installed in areas with frequent snow removal operations. It is desirable to design a vertically tapered island approach on the leading edge of the island. A 3:1 vertical taper to establish a curbed nose allows a snowplow to ride up and over the nose without damaging the curb and plow.

Refer to Figure 9-40 in the 2018 AASHTO GDHS.

8.8.8 Corner Islands for Turning Roadways

The turning roadway pavement should be wide enough to permit the outer and the inner wheel tracks of a selected vehicle to be within the edges of the pavement by about 2 feet on each side. Generally, the turning roadway pavement width should not be less than 14 feet. For designs of turning roadways of 90 degrees with minimum corner islands, refer to Figure 9-38 of the 2018 AASHTO GDHS.

Minimum design dimensions for oblique-angle turns, determined on a basis similar to that for right-angle turns, are given in Table 8-4. Curve design for the inner edge of pavement, turning roadway pavement width, and the approximate island size are indicated for the three chosen design classifications described at the bottom of the table. For a particular intersection, the designer may choose from the designs shown in accordance with the size of vehicles, the volume of traffic anticipated, and the physical controls at the site.

In Table 8-4, design values are not given for angles of turn less than 75 degrees. Turning roadways for flat angle turns involve relatively large radii and are not considered in the minimum class. Such arrangements require a design that fits site controls and traffic conditions. For angles of turn between 75 and 120 degrees, the designs are governed by a minimum island, providing for turns on more than minimum turning radii. For angles of 120 degrees or more, the design is generally controlled by the sharpest turning paths of the selected vehicles, and arrangements of curves on the inner edge of traveled way to fit these paths. The resulting island size is greater than the minimum. The size of the island for the large turning angles in Table 8-4 is indicative of the otherwise unused and uncontrolled areas of traveled way that are eliminated by the use of an island.



Table 8-4 Typical Designs for Turning Roadways

Three-Centered Curve					
Angle of Turn (degrees)	Design Classification	Radii (ft)	Offset (ft)	Width of Lane (ft)	Approximate Island Size (sq ft)
75	A	150-75-150	3.5	14	60
	B	150-75-150	5.0	18	50
	C	220-135-220	5.0	22	360
90	A	150-50-150	3.0	14	50
	B	150-50-150	11.0	21	150
	C	200-70-200	11.0	25	270
105	A	120-40-120	2.0	15	70
	B	150-35-150	11.5	29	65
	C	180-60-180	9.5	32	260
120	A	100-30-100	2.5	16	120
	B	150-30-150	10.5	33	130
	C	140-55-140	7.0	45	215
135	A	100-30-100	2.5	16	460
	B	150-30-150	10.0	38	395
	C	140-45-140	7.0	52	485
150	A	100-30-100	2.5	16	1400
	B	150-30-150	9.0	42	1350
	C	160-40-160	6.0	53	1590

- A Primarily passenger vehicles; permits occasional design single-unit truck to turn with restricted clearances.
- B Provides adequately for SU-9 [SU-30] and SU-12 [SU-40] design vehicles; permits occasional WB-19 [WB-62] design vehicles to turn with slight encroachment on adjacent traffic lanes.
- C Provides fully for WB-19 [WB-62] design vehicle.

Asymmetric three-centered compound curves and straight tapers with a simple curve can also be used without significantly altering the width of roadway or corner island size.

8.9 Design to Discourage Wrong-Way Entry

Intersections of crossroads at major highway interchanges have an inherent problem of the possibility of a wrong way driver entering one of the exit ramps from the crossroad and proceeding along a major highway in the wrong direction in spite of signing. Attention to several details of design at the intersection can discourage this hazardous maneuver.

Details of designs to discourage wrong-way entry are shown in Figures 10-58 and 10-59 of the 2018 AASHTO GDHS.

8.10 Superelevation at Intersections

8.10.1 General Design Guidelines

Poorly designed drainage can create operational issues on low-speed roadways. Cross slopes of the two roadways that are not transitioned properly as they approach the intersection can cause water ponding creating operational and safety issues for drivers. Refer to Tables 9-19 and 9-20, and Figures 9-44 to 9-47 of the 2018 AASHTO GDHS.

8.10.2 Superelevation Runoff

Superelevation runoff and intersection spacing may come into conflict at locations with tight intersection spacing. The designer needs to carefully consider if superelevation is appropriate when multiple intersections are closely spaced together. The first indication of changing or removing superelevation with intersections is if the superelevation runoff cannot be effectively completed due to limited spacing between intersections.

8.10.3 Development of Superelevation at Turning Roadway Ramp Terminals

The designer should establish a superelevation runoff from the end of the intersection ramp terminal before superelevation is fully established. Moving the superelevation too close to the ramp terminal can cause issues with drainage, stopping sight distance, and vehicle handling when starting from a stopped condition on a superelevated roadway.

8.11 Stopping Sight Distance at Intersections for Turning Roadways

8.11.1 General Design Guidelines

The values for stopping sight distance as computed in Chapter 6 for open highway conditions are applicable to roadway intersections of the same design speed.

Refer also to Table 9-21 in the 2018 AASHTO GDHS and Table 3-1 in Chapter 3 of this Guide.

8.12 Auxiliary (Speed Change) Lanes

The primary purpose of an auxiliary lane at an intersection is to provide storage for left- and right-turning vehicles. A secondary purpose is to provide space for turning vehicles to decelerate from the normal speed of traffic to a stopped position in advance of the intersection or to a safe speed for the turn in case a stop is unnecessary. Additionally, an auxiliary lane may be provided for bus stops or for loading and unloading passengers from passenger cars.

A speed change lane is an auxiliary lane with tapered areas, primarily for the acceleration or deceleration of vehicles entering or leaving the through traffic lanes. The terms “speed-change lane,” “deceleration lane,” or “acceleration lane,” as used here, apply broadly to the added pavement joining the traveled way of the highway or street with that of the turning roadway and do not necessarily imply a definite lane of uniform width.

Speed-change lanes may be justified on high-speed and high-volume highways where a change in speed of 10 mph or more is necessary during acceleration and deceleration for vehicles entering or leaving the through traffic lanes.

8.12.1 General Design Considerations

Desirably, the total length of the auxiliary lane should be the sum of the length for three components (storage length, deceleration or acceleration length, and taper length). Where intersections occur as frequently as four per mile and posted speed is less than 45 mph, it is customary to forego most of the deceleration length and to provide only the storage length plus taper. On a roadway with posted speed of 45 mph or higher, the deceleration and acceleration length shall be included in the auxiliary lane length.

Each component of the auxiliary lane length is discussed in the following sections. Where geographically possible, a continuous auxiliary lane shall be established between accesses in instances where speed change lanes overlap or are separated by less than 300 feet or half their length (whichever is shorter). Figure 8-5 illustrates basic auxiliary lane elements.

Figure 8-5 Information Guide to Basic Auxiliary Lane Elements

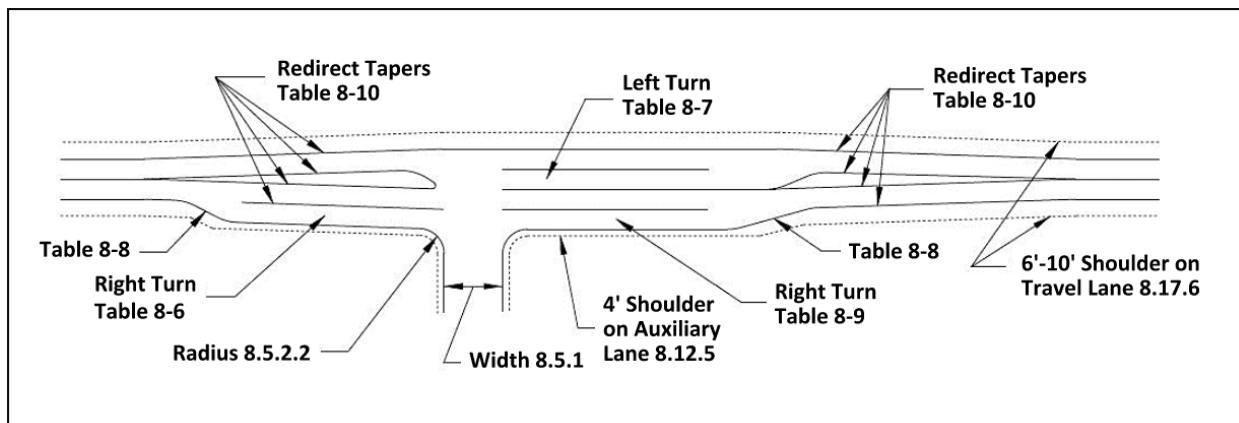

Auxiliary lanes should be at least 10 feet wide and desirably should equal the width of the through lane. Where curbing is to be used adjacent to the auxiliary lane, an appropriate curb offset should be provided. The paved shoulder width adjacent to an auxiliary lane can be narrower than the standard shoulder for the roadway but should allow for a uniform transition to the standard shoulder when the lane transition ends. The length of the auxiliary lanes for turning vehicles consists of three components:

- Deceleration length.
- Storage length.
- Entering taper.

Warrants for the use of auxiliary lanes cannot be stated definitively. If the designer is unsure about when to apply speed change lanes, a traffic engineer can assist. Observations and considerable experience with speed change lanes have led to the following general conclusions:

- Speed-change lanes are warranted on high-speed and high-volume highways where a change in speed is necessary for vehicles entering or leaving the through traffic lanes.
- All drivers do not use speed change lanes in the same manner - some use little of the available facility. As a whole, however, these lanes are used sufficiently to improve the overall safety and operation of the highway.
- Use of speed change lanes varies with volume; the majority of drivers use the lanes during high volumes.
- The directional type of speed-change lane consisting of a long taper fits the behavior of most drivers and does not require maneuvering on a reverse curve path.
- Deceleration lanes on the approaches to intersections that also function as storage lanes for turning traffic are particularly advantageous, and experience with them generally has been favorable. Such lanes reduce hazards and increase capacity.

A deceleration lane is advantageous, particularly on high-speed roads, so a driver of a vehicle leaving the highway can use it to slow down outside of the through traffic lane. The speed differential of a vehicle slowing in the through traffic lane can result in increased potential for rear-end collisions.

Acceleration lanes are not always necessary at stop-controlled intersections where drivers entering the flow of traffic can wait for an opportunity to merge without disrupting traffic flows. Acceleration lanes are advantageous on highways without stop control and on high-volume roads even with stop sign control where openings between vehicles in the peak hour traffic streams are infrequent and short.

On urban streets with high volumes of traffic, acceleration lanes provide little benefit as there may not be sufficient gaps in traffic flow to provide a safe merging operation for the driver. Some drivers even stop in the acceleration lane waiting for an opening in traffic, which can result in rear-end crashes.

The use and design of speed change lanes differ between roadway types. Table 8-5 defines the speed change lane design components for facility types. Consultation with a traffic engineer can help determine the need for auxiliary lanes by calculating the roadway's capacity and determining if the operational capacity could be improved by the addition of acceleration and deceleration lanes.



Table 8-5 Components of Speed Change Lane Length

Facility Type and Context Classification	Left-Turn Deceleration Lane	Right-Turn Deceleration Lane	Acceleration Lane
Freeway C1 - C6	Design must meet federal interstate standards, and no less than expressway standards.		
Expressway C1 - C6	Taper + Decel. Length + Storage	Taper + Decel. Length	Accel. Length + Taper
Street C5 - C6	Taper + Storage	Taper + Storage	*Accel. Length
Street ≤ 40 mph C3 - C4	*Decel. Length	*Decel. Length	*Accel. Length
Street > 40 mph C3 - C4	*Decel. Length	*Decel. Length	*Accel. Length
Road ≤ 40 mph C1 - C3	*Decel. Length + Storage	*Decel. Length	*Accel. Length
Road > 40 mph C1 - C3	*Decel. Length + Storage	*Decel. Length	*Accel. Length

*Taper length is included within stated Acceleration or Deceleration Length.

8.12.2 Deceleration Lanes

The functional area of an intersection with relation to the deceleration lane length is shown in Figure 8-6. This graphic illustrates the upstream functional area of an intersection with three components: perception-reaction distance, deceleration length, and storage length. The physical length of the deceleration lane includes the taper length, the deceleration length, and the storage length.

Figure 8-6 Functional Area Upstream of an Intersection Illustrating Components of Deceleration Lane Length

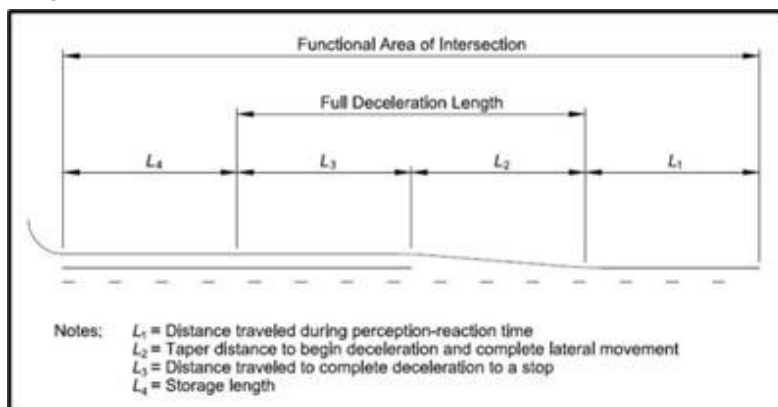

Source: Figure 9-48 of the 2018 AASHTO GDHS.



Table 8-6 represents the estimated distances to maneuver from the through lane into a turn bay and brake to a stop. It is not always practical to provide the full deceleration length of the auxiliary lane for deceleration because of constrained right of way or the available distance between intersections. In these cases, the driver should begin deceleration prior to entering the auxiliary lane.

Table 8-6 Desirable Full Deceleration Length

Speed (mph)	20	30	40	50	60	70
Distance ^a (feet)	70	160	275	425	605	820

^a Rounded to the nearest 5 feet.

8.12.2.1 Perception-Reaction Time

Perception-reaction time is the amount of time it takes for a driver to perceive and recognize the upcoming turn lane and prepare to use the turn lane. For more information on perception-reaction time refer to Chapter 9, Section 9.7.2.1, of the 2018 AASHTO GDHS.

8.12.2.2 Storage Length

The auxiliary lane should be sufficiently long:

- To store the number of vehicles likely to accumulate during a critical period.
- To avoid the possibility of left-turning vehicles stopping in the through lane waiting for a signal change or for a gap in the opposing traffic flow.

At unsignalized intersections, the storage length, exclusive of taper, may be based on the number of turning vehicles likely to arrive in an average two-minute period within the peak hour. The two-minute waiting time may need to be changed to some other interval that depends largely on the opportunities for completing the left-turn maneuver. These intervals, in turn, depend on the volume of opposing traffic. Where the volume of turning traffic is high, traffic signal warrants should be performed. It would be advisable to engage a traffic engineer to perform the signal warrant analysis.

There are several techniques to determine the necessary storage length. Desirable auxiliary lane lengths for vehicles to come to a stop at an unsignalized intersection are provided in Table 8-7.

Table 8-7 Storage Lengths for Auxiliary Lanes at Unsignalized Intersections

Turning Vehicles Per Peak Hour	Below 30	30	60	100	200	300
Required Storage Length (ft)	25	40*	50*	100	200	300

*Minimum storage length is 100 ft when trucks equal or exceed 10% of turning vehicles.

A left-turning volume of 200 vehicles per hour, or more, cannot complete the turn without difficulty unless the volume of opposing through traffic during the same hour is about 88 or less.

Turning volumes in this range usually require special design or traffic signal control. Storage lengths for signalized intersections may be determined from highway capacity nomographs in the *Highway Capacity Manual* (TRB, 2022).

The designer should check with the local agency to ascertain their established minimum lengths for auxiliary lanes with low turn volumes for secondary roadways.

The important factors that determine the storage length needed are:

- The design year volume for the peak hour.
- An estimate for the number of cycles per hour if the location is signalized.
- The type of signal phasing and timing that will control the left-turn movement. The designer should seek guidance through coordination with the Traffic Engineer.
- To reduce the total length of queues formed in the left-turn lane, it is an allowable practice to allow “permissive” turns following “protected” turn phases. Permissive turns are made when gaps in opposing traffic occur and can increase the capacity of a turn lane from 20 to 50%.
- Another alternative is to identify if a flashing yellow arrow would be allowed by the traffic engineer for left-turning traffic movements. A flashing yellow left-turn arrow allows permissive lefts to occur and possibly clear the queue during the green phase. If the queue does not clear, the signal can provide an end of green left-turn phase to clear the remaining vehicles.

Median bay tapers (asymmetrical reverse curves) may be used for deceleration transition tapers. Use of a bay taper and auxiliary lane striping will reduce drifting of the through vehicles into the deceleration lane. Where there are horizontal or crest vertical curves, consider using a bay taper for more visible definition. Figure 8-7 illustrates asymmetrical reverse curves for a median bay taper.



8.12.2.3 Elements of Left-Turn Design (Lane Drop and Redirect Tapers)

Lane drop and lane transition (redirect) tapers should be designed to encourage efficient operation and reduce crashes. The lane-drop and lane transition (redirect) taper length where the posted or statutory speed limit is 45 mph or greater should be computed with Equation 8-1, based on the MUTCD. Where the posted or statutory speed limit is less than 45 mph, the lane-drop or redirect taper length should be computed with Equation 8-2.

For speeds equal to or greater than 45 mph: $L = WS$

Where,

L = length of taper (ft)

S = posted or statutory speed (mph)

W = offset (ft)

$$L = \frac{WS^2}{60}$$

For speeds less than 45 mph:

8.12.2.4 Taper Length

To develop the width needed for auxiliary lanes, a transition (or taper) must be established in advance of the auxiliary lane. This taper allows a driver to recognize that an exclusive lane is becoming available and allows some deceleration to occur prior to entering the storage lane itself.

Design configurations for straight-line and curved tapers are shown in Chapter 9 of the 2018 AASHTO GDHS. Recommended taper ratios for speed-change lanes are given in Table 8-8.

Table 8-8 Taper Length and Ratio for Parallel-Type Entrance

Posted Speed (mph)	25	30	35	40	45	50	55	60 ^a	65 ^a	70 ^a
Taper Ratio ^b	7.5:1	8:1	10:1	12:1	13.5:1	15:1	18.5:1	25:1	25:1	25:1

^aUniform 50:1 to 70:1 tapers are recommended where lengths of acceleration lanes exceed 1300 feet.

^bTaper Length equals taper ratio times lane width.

8.12.3 Acceleration Length

Acceleration lanes are used when there is a free-flow right and the *Highway Capacity Manual* (TRB, 2022) dictates. For traffic signal warrants, refer to Chapter 15 of this Guide. For design, refer to Table 8-9.

Table 8-9 Desirable Acceleration Length from Stop Condition

Design Speed (mph)	30	35	40	45	50	55	60	65	70	75
Acceleration Length (feet)	180	280	360	560	720	960	1200	1410	1620	1790

*These approximate lengths are based on grades less than 3%.

Provision for acceleration clear of the through traffic lanes is a desirable objective on arterial roads and streets and should be incorporated into design whenever feasible and practicable (refer to the State Highway Access Code [State of Colorado, 2002] for guidance on warrants). The total length required is that needed to reach a safe and comfortable speed to enter the through lane. Acceleration requirements are as shown in Figure 10-69 and Tables 10-3 to 10-4 of the 2018 AASHTO GDHS.



When the roadway is operating in context classifications C4, C5, and C6, the addition of acceleration lanes may not be appropriate. Acceleration lanes are to help a vehicle reach operating speed before entering the through lane. In urban areas this is not as critical, and the acceleration lane can pose greater risks to pedestrians by lengthening the crossing distances across the roadway and creating conflict areas with bicycle activity. The designer should weigh the benefit and need for the acceleration lane versus the potential safety impacts of this on other travel modes.

8.12.4 Speed Change Lane Width

Speed change lane widths must be a minimum of 11 feet, not including the gutter pan or shoulder, whenever posted speeds are greater than 40 mph, or when truck volumes exceed 9%. Ten-foot lanes may be used in instances where the posted speed limit is less than 45 mph, and truck volumes are less than 10%, so long as the local agency design standards allow. In instances where adjacent travel lanes are 12 feet wide, the speed change lane should be designed at 12 feet wide. Figure 8-8 illustrates speed-change lane taper for continuously curbed medians.

8.12.5 Shoulder Width Along Speed Change Lanes Where Curbs Are Not Present

Shoulders must be present in all locations where there is no curb and gutter. Shoulders adjacent to through travel lanes should be six feet wide, but no less than the existing shoulder width. Shoulders along speed change lanes shall be a minimum of 4 feet wide.

8.12.6 Design Treatments for Left-Turn Maneuvers

If there is sufficient median width, the ideal design treatment is to have the left-turn lane offset to the left of the opposing turn lane at the intersection. The offset to the left of the opposing lane increases the driver's sight distance to better see and anticipate gaps in approaching traffic. This is also a benefit where large trucks are regularly making left-turns.

8.12.6.1 Guidelines for Provision and Design of Left-Turn Bypass Lanes

A left-turn bypass lane is often associated with alternative intersection designs. One example is an advanced left lane at a continuous flow intersection (CFI) where the left-turn bypass occurs in advance of the intersection. This allows the left-turn movement on the major movement to occur simultaneously with the minor street through movement. There are other examples of this, and current modeling software should be used to help evaluate the viability and benefits of alternative intersections such as this example.

Figure 8-8 Speed-Change Lane Taper for Continuously Curbed Medians

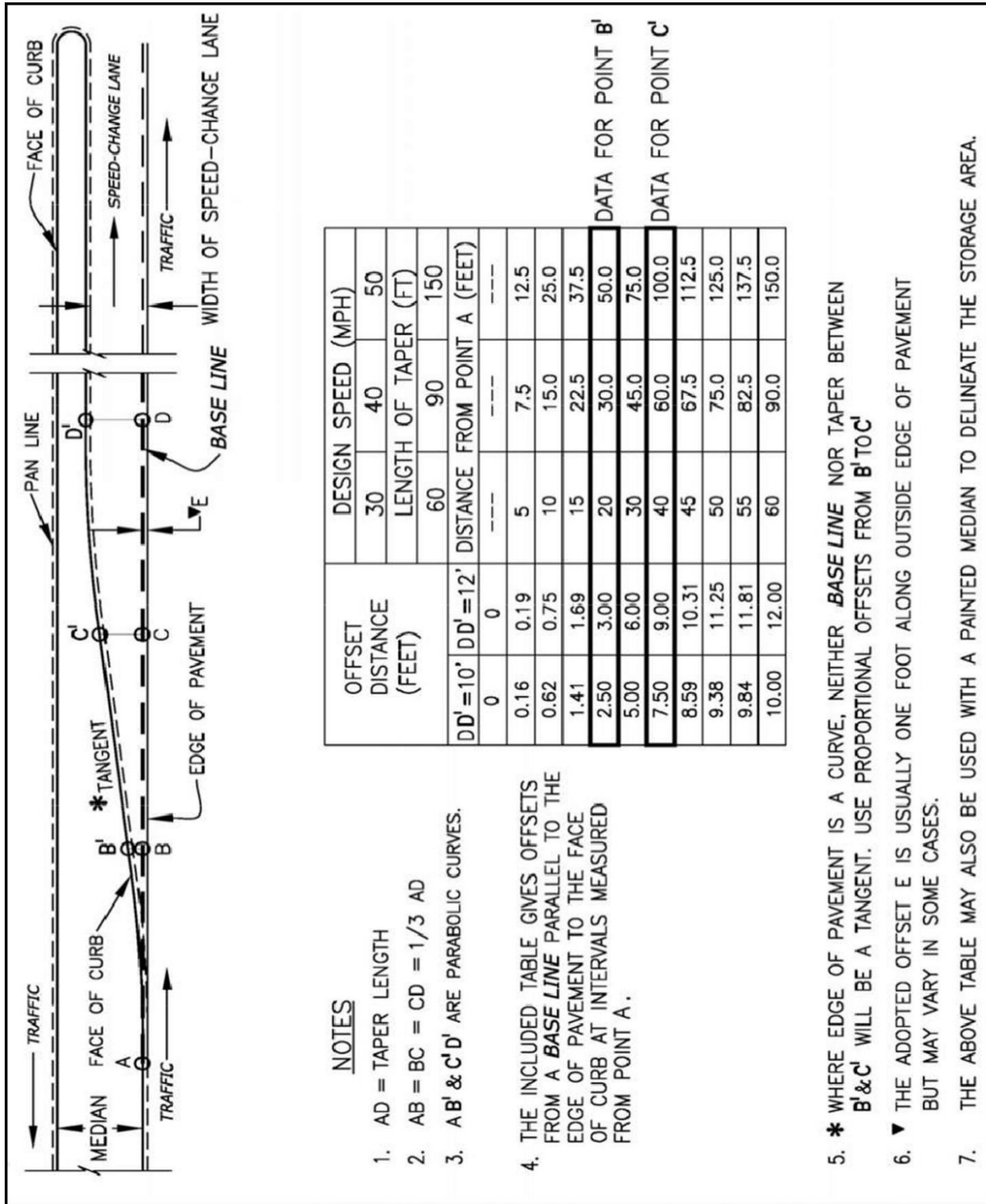

8.12.6.2 Median Left-Turn Lanes

Accommodation of left-turns in many cases is the critical factor in design of intersections. Provisions for left-turn lanes greatly influence both level of service and intersection safety.

A median lane provides refuge for vehicles awaiting an opportunity to turn, and thereby keeps the highway traveled way clear for through traffic. The width, length, and general design of median lanes are similar to those of any other deceleration lane, but their design includes some additional features. Examples of median left-turn channelization are shown in Figures 8-9A and 8-9B.

Analysis of conflicts involving left turns shows why their treatment is so critical. Left-turning vehicles conflict with:

- Opposing through traffic.
- Crossing traffic.
- Through traffic in the same direction.

Median widths of 20 feet or more are desirable at intersections with single-median lanes, but widths of 16 to 18 feet permit reasonably adequate arrangements. Where two median lanes are used, a median width of at least 28 feet is desirable to permit the installation of two 12-foot lanes and a 4-foot separator. Although not equal in width to a normal traveled lane, a 10-foot lane with a 2-foot curbed separator or paint lines separating the median lane from the opposing through lane may be acceptable where speeds are low, and the intersection is controlled by traffic signals.



Figure 8-9A Minimum Median Left-Turn Channelization, Four-Leg Intersection

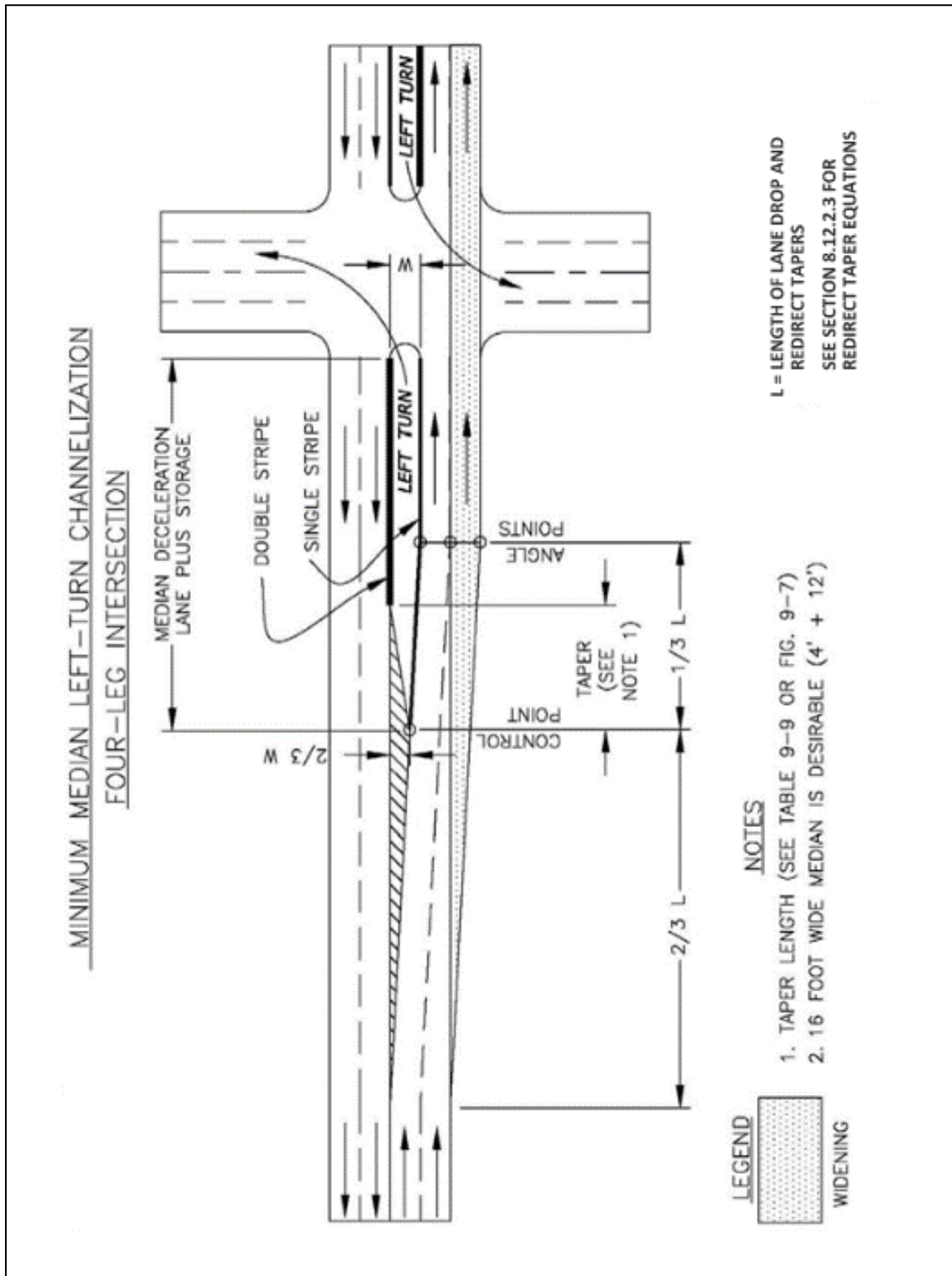
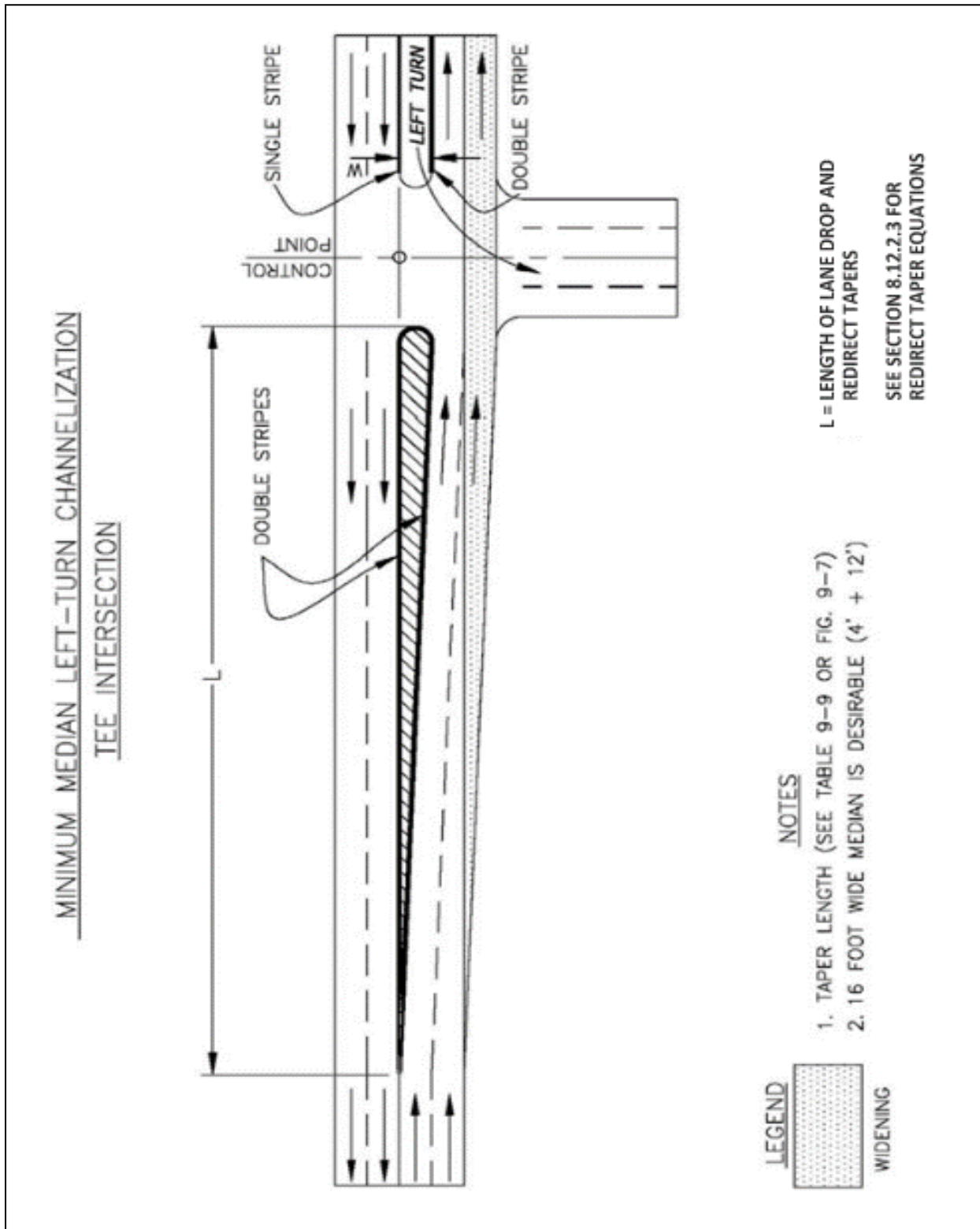



Figure 8-9B Minimum Median Left-Turn Channelization, Tee Intersection



8.12.6.3 Median Left-Turn Lane Warrants

Because of the many variables involved, it is not feasible to develop guidelines for all conditions at signalized intersections. However, the following information should be considered in evaluating left-turn needs at specific locations.

At high-speed, rural-signalized intersections, separate left-turn lanes are considered necessary for safe operations. While capacity is not generally a problem, protection of queued left-turning vehicles from through vehicles is critical. Because the availability and cost of right of way can be expensive, it is important to objectively evaluate and calculate traffic queueing for the turning movement to determine the necessity for a separate left-turn lane.

To facilitate flow where the intersection is unsignalized, the following guidelines are suggested:

- Left-turn lanes should be considered at all median crossovers on divided, high-speed highways.
- Left-turn lanes should be provided at all uncontrolled approaches of primary, high-speed rural highway intersections with other arterials and collectors.
- Left-turn lanes should be provided on stopped or secondary approaches based on analysis of the capacity and operations of the unsignalized intersection.

8.12.6.4 Median End Treatment

The form of treatment at the end of the narrowed median adjacent to lanes of opposing traffic depends largely on the available width. The narrowed median may be curbed to delineate the lane edge, to separate opposing movements, to provide space for necessary signs, markers, and lighting standards, and to protect pedestrians.

For medians wider than about 18 feet, as shown in Figure 9-10C and in Figure 9-51 in the 2018 AASHTO GDHS, it is usually preferable to align the left lane in a manner that will reduce the width of the divider to 6 to 8 feet immediately in advance of the intersection, rather than to align it exactly parallel with and adjacent to the through lane. This alignment places the vehicle waiting to make the turn as far to the left as practical and improves visibility of opposing through traffic. The advantages of offsetting the left-turn lanes are:

- Better visibility of opposing through traffic.
- Decreased possibility of conflict between opposing left-turn movements within the intersection.
- More left-turn vehicles served in a given period of time, particularly at a signalized intersection.

For curbed dividers 4 feet or more in width at the narrowest end, the curbed nose can be offset from the opposing through traffic lane 2 feet or more, with gradual taper beyond to make it less vulnerable to contact by through traffic. The shape of the nose for curbed dividers 4 feet wide usually is semicircular, but for wider widths the ends are normally shaped to a bullet nose pattern to conform better to the paths of turning vehicles.

8.12.6.5 Offset Left-Turn Lanes

Refer to Chapter 9, Section 9.7.3.4, of the 2018 AASHTO GDHS for information on offset left-turn lanes.

8.12.6.6 Simultaneous Left-Turns

Refer to Chapter 9, Section 9.7.3.5, of the 2018 AASHTO GDHS for information on simultaneous turn lanes.

8.12.6.7 Double or Triple Left-Turn Lanes

Double left-turn lanes have been applied successfully nationwide at locations with severe capacity or operational problems. Their applicability is generally greatest at high volume intersections with significant left-turning volumes in one or more direction. Double left-turn lanes should be considered at any signalized intersection with high design hour demand for left-turns. As a general rule, left-turn volumes of 300 vehicles per hour or more are appropriate for consideration for double left-turn lanes.

Left-turning vehicles leave the through pavement to enter the median lanes in single file, but once within it, store in two lanes and, on receiving the green indication, turn simultaneously from both lanes. With three-phase signal control, such an arrangement results in an increase in capacity of approximately 180% of that of a single median lane. Because of the high turning volumes, double left-turn lanes should only be used with fully protected signal phasing.

Where there are two left-turn lanes, the storage length can be reduced to approximately 0.6 of that required for single-lane operation. Ideally a traffic modeling analysis should be completed to determine the storage area that is necessary for two left-turn lanes.

The widening on the curve for the two lanes of turning traffic is an important design element. Drivers are most comfortable with extra space between the turning queues of traffic. Because of off-tracking characteristics of vehicles and the relative difficulty of two abreast turns, a 36-foot width for the two lanes on the curve is desirable. In constrained situations, a 30-foot width on the curve is an acceptable minimum. Vehicle tracking patterns from both directions need to be evaluated for turning movement conflicts. If opposing movements conflict, the intersection may need to be modified to alleviate the turning conflicts, or the opposing turning movements need to be phased separately.

A summary of the current use of triple left-turn lanes can be found in the Florida DOT report *Triple Left Turn Lanes at Signalized Intersections* (FDOT, 2002).

8.12.6.8 Median Lane Width

A median width of 20 feet or more is desirable at intersections with single-median lanes, but widths of 16 to 18 feet permit reasonably adequate arrangements. The minimum narrowed median width of no less than 4 feet is recommended, but 6 to 8 feet wide is preferred. These dimensions can be provided within a median 16 to 18 feet wide and a turning lane width of 10 to 12 feet.



Widening of the highway equally on both sides of the centerline may be required to accommodate the median area.

Figures 8-10A and 8-10B show a minimum design for a median left-turn lane within a 14- to 18-foot median. The left-turn lane is 10 to 12 feet wide with a 4-foot wide median. Figure 8-10C shows a design for a median left-turn lane with a median greater than 18 feet.



Figure 8-10A 14 to 16-Foot Median Left-Turn Design

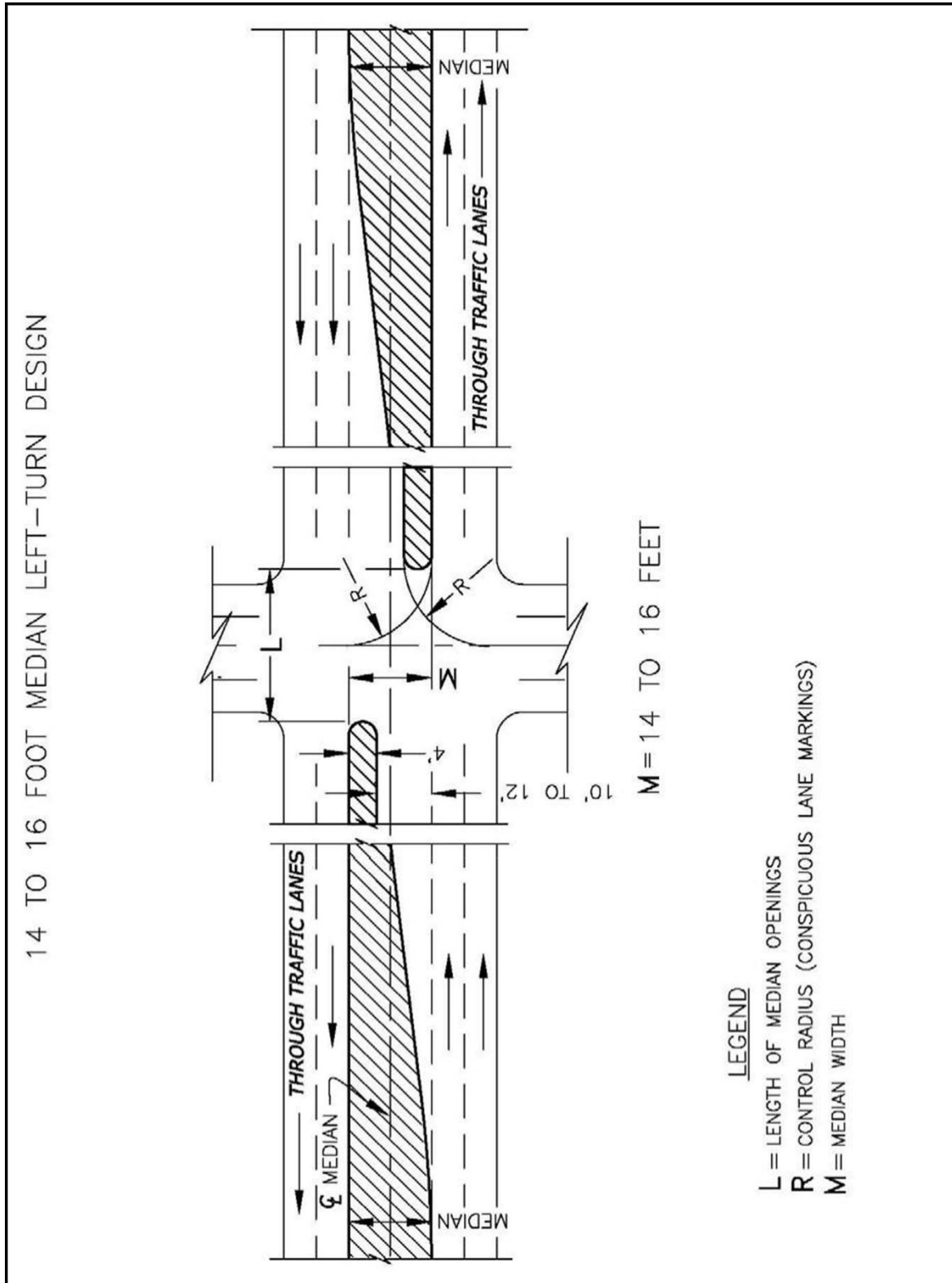



Figure 8-10B 16 to 18-Foot Median Left-Turn Design

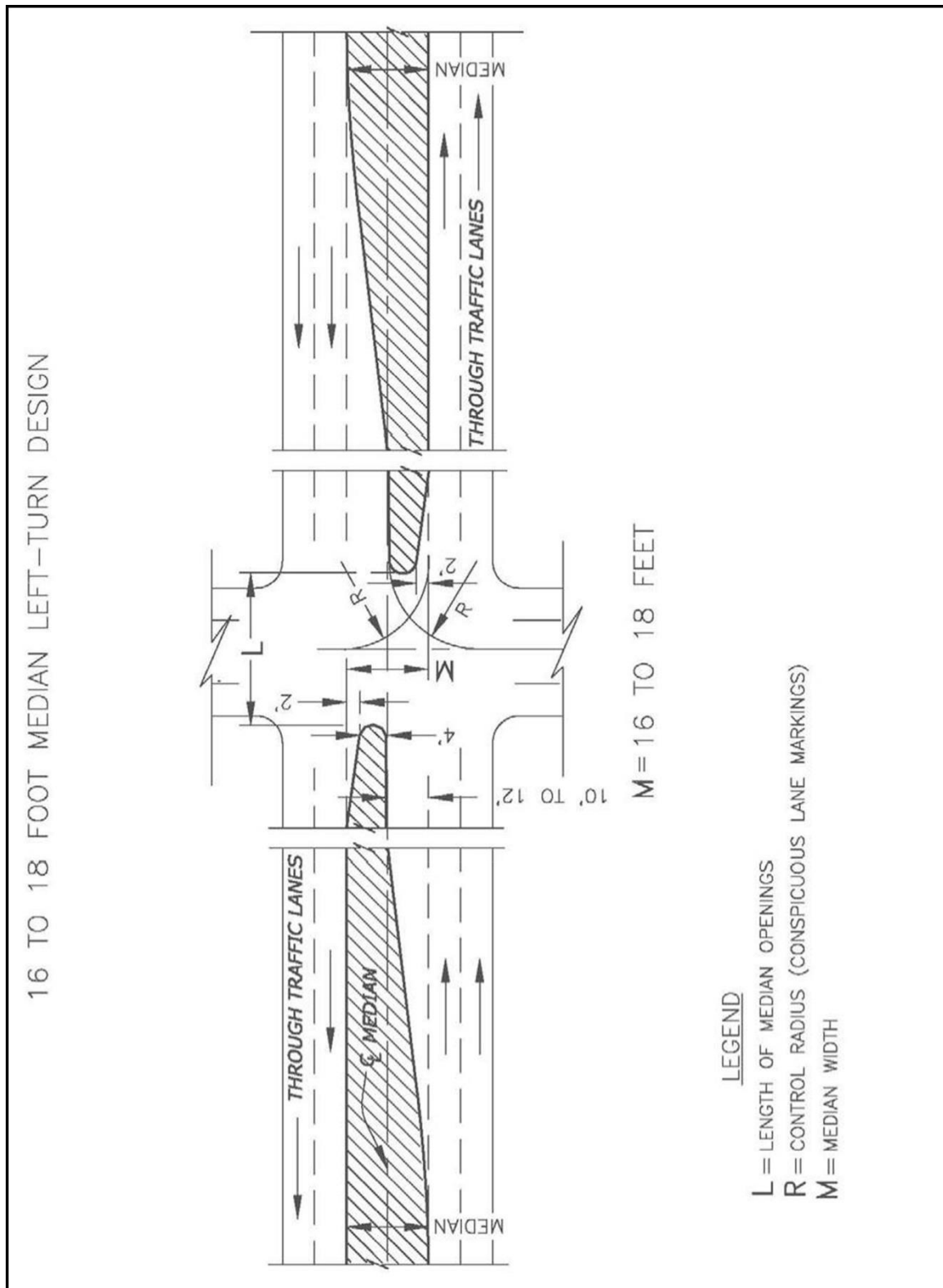
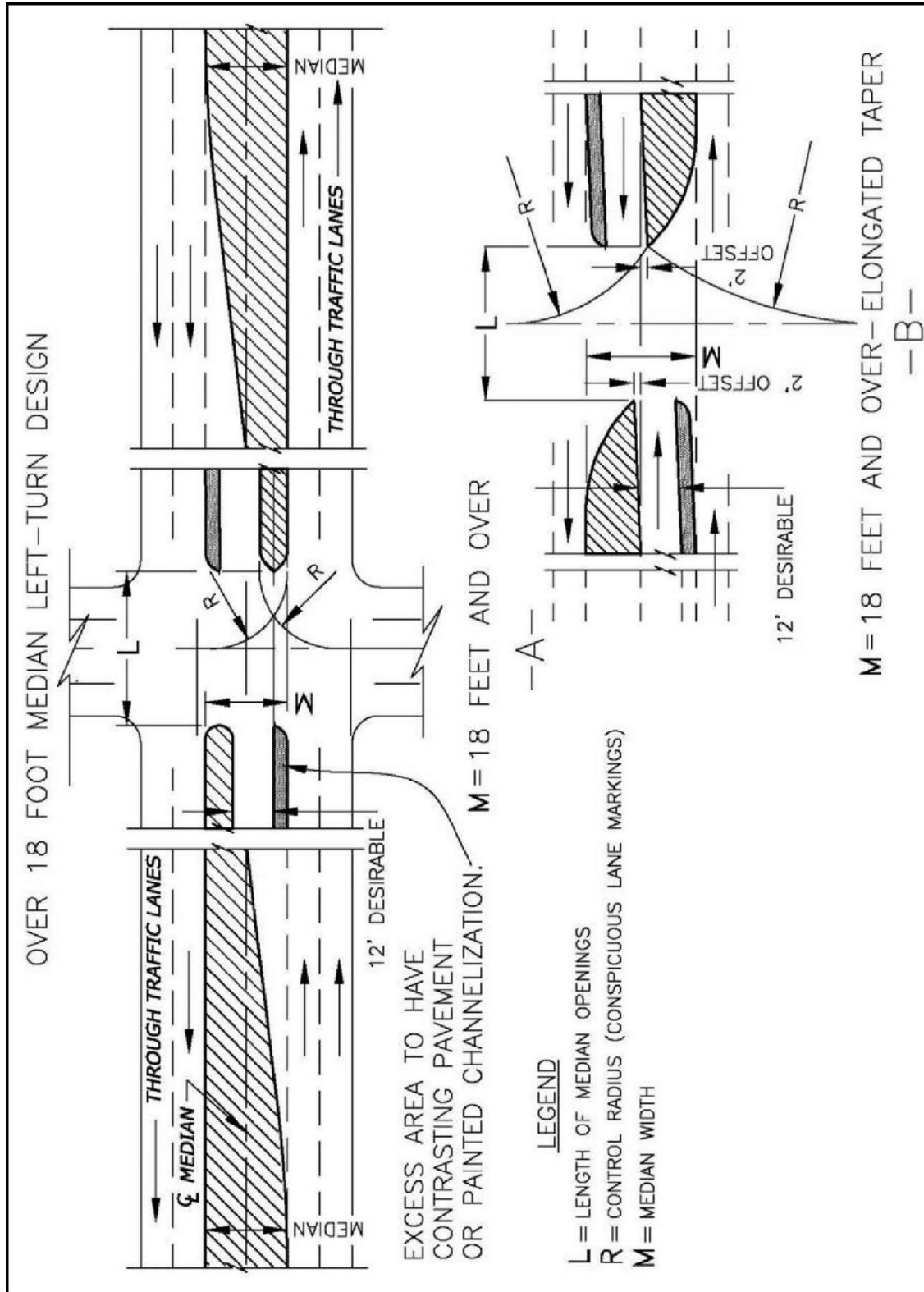



Figure 8-10C Median Left-Turn Design for Median Width Greater Than 18 Feet





8.13 Median Openings

8.13.1 General Design Considerations

Refer to Tables 9-25 through 9-27 and Figures 9-55 through 9-58 in the 2018 AASHTO GDHS.

Medians are discussed in Chapter 4 of this Guide chiefly as an element of the cross section. In Chapter 4, general ranges in width are given, and the width of the median at intersections is treated briefly.

For intersections, the median width, the length of the opening, and the design of a median opening and median ends should be based on traffic volumes and type of turning vehicles. Cross and turning traffic must operate in conjunction with the through traffic on the divided highway. This requirement makes it necessary to know the volume and composition of all movements occurring simultaneously during the design peak hours.

The design of a median opening becomes a matter of considering what traffic is to be accommodated, choosing the design vehicle to use for layout controls for each cross and turning movement, investigating whether larger vehicles can turn without undue encroachment on adjacent lanes, and finally checking the intersection for capacity. If the capacity is exceeded by the traffic load, the design must be expanded, possibly by widening or otherwise adjusting widths for certain movements.



If a median is primarily used by pedestrians, it should be raised and at minimum match the width of the continuing path. If the median is wide enough, an angled cut-through should be provided to position pedestrians and bicyclists to face oncoming traffic. If a median is primarily used by bicycles, designers should consider keeping the median crossing flat to avoid pedal strikes. Median refuge areas for pedestrians should be at least 6 feet wide to provide sufficient refuge to protect a bicyclist or a person pushing a stroller, but any refuge is better than none.

8.13.2 Control Radii for Minimum Turning Paths

An important factor in designing median openings is the path of each design vehicle making a minimum left-turn at 10 to 15 mph. Where the volumes and types of vehicles making the left-turn movements call for higher than minimum speed, the design may be made by using a radius of turn corresponding to the speed deemed appropriate. However, the minimum turning path at low speed is needed for minimum design and for testing layouts developed for one vehicle with an occasional larger vehicle.

The paths of design vehicles making right-turns are shown in Chapter 2 of the 2018 AASHTO GDHS. Any differences between the minimum turning radii for left-turns and those for right-turns are small and are insignificant in highway design. Minimum 90-degree left-turn paths for design vehicles are shown in Figure 9-54 of the 2018 AASHTO GDHS. Turning templates, whether electronic or transparent, for various design vehicles should be utilized.

By considering the range of radii for minimum right-turns and the need to accommodate more than one type of vehicle at intersections, the following control radii can be used for minimum practical design of median ends:

- A control radius of 40 feet accommodates P vehicles suitably and occasional SU-30 vehicles with some swinging wide.
- A control radius of 50 feet accommodates SU-30 vehicles and occasional WB-40 vehicles with some swinging wide.
- A control radius of 75 feet accommodates WB-40 vehicles.
- A control radius of 130 feet accommodates WB-62 and occasionally WB-67 vehicles.

Refer to Figures 9-55 to 9-58 of the 2018 AASHTO GDHS.

8.13.3 Shape of Median End

One shape of a median end at an opening is a semicircle as shown in Figure 8-11. This simple design is satisfactory for narrow medians. For medians greater than about 10 feet in width, the bullet nose is superior to the semicircular end. Consider plowable end treatments with a minimum 3:1 slope from the pan to top of curb.

Alternate minimum designs for median ends to fit the design control radii of 40, 50, 75 and 130 feet are shown in Chapter 9 of the 2018 AASHTO GDHS. Refer to Figures 9-55 to 9-58 of the 2018 AASHTO GDHS.

8.13.4 Effect of Skew

Using a control radius for design vehicles as the basis for minimum design of median openings results in opening lengths that increase with the skew angle of the intersection. Refer to Tables 9-28 and 9-29 of the 2018 AASHTO GDHS for details of the effect of skewed crossings on the length of median openings.

8.13.5 Design Considerations for Higher Speed Left-Turns

Refer to Figure 9-59 of the 2018 AASHTO GDHS.



8.14 Flush or Traversable Medians

The discussion in Section 8.15 of this chapter on design for indirect left-turns and U-turns with raised curb medians brings into focus the difficulties involved in providing access to abutting properties, especially where such access is by commercial vehicles. These conditions are common in commercial and industrial areas where property values are high and right of way for wide medians is difficult to acquire. A flush or traversable median by design does not have any physical obstruction that would prohibit it from being crossed with ease and comfort. However, the intent of the flush or traversable median is to create a contrast in the pavement section for motorists to avoid crossing.

One method for solving this left-turn conflict problem while maintaining access to roadside activities is the use of continuous two-way left-turn lanes. Two-way left-turn lanes (TWLTL) should be considered where there is a history of midblock crashes involving left-turning vehicles, multiple driveways are closely spaced, or where there are strip development or multiple-unit residential land use along the corridor.

A number of studies have evaluated the cost-effectiveness of TWLTLs. Based on these studies, the following warrants and guidelines are suggested for their application:

- Annual Average Daily Traffic (AADT) - four lanes - between 10,000 and 20,000 vehicles, or two lanes - between 5,000 and 12,000 vehicles.
- Left-turn volumes - 70 midblock turns per 1,000 feet, or at least 20% of total volume making left-turns in the peak hour.
- Minimum length - 1,000 feet, or 2 to 3 blocks.

In general, TWLTLs can be considered when operating speeds are 50 mph or less and AADT is below 24,000 ADT for the roadway segment. TWLTL widths in use range from 10 to 16 feet. Table 8-10 provides suggested lane widths for various types of highways. Designs for new facilities should strive for median lane widths of 12 to 14 feet.

Table 8-10 Lane Widths for Continuous Two-Way Left-Turn Lanes

Lane Widths for Continuous Two-Way Left-Turn Lanes		
Prevailing Speed (mph)	Lane Use (Vehicle Type)	Appropriate Width of Lane (ft)
25 to 30	Residential, business (passenger cars)	9 ft absolute minimum, 12 ft desirable
30 to 40	Business (passenger cars, some trucks)	12 ft minimum, 14 ft desirable
	Industrial (many large trucks)	14 ft to 16 ft
40 to 50	Business	12 ft minimum, 14 ft desirable

Conversion of existing cross sections typically has more constraints. Narrow widths should be avoided except for on low-speed streets. Lane widths should not be so great, however, that shared use of the lane (i.e., side-by-side) by opposing drivers is created.

The TWLTL is generally continued through minor or unsignalized intersections. For signalized intersections or those controlled by four-way stops, it is generally advisable to restrict entry into the lane for a reasonable distance from the intersection using pavement markings.

8.15 Indirect Left-Turns and U-Turns

8.15.1 General Design Considerations

Indirect left-turns and U-turns can be used to achieve safe and efficient left-turn operations near intersections in the following situations:

- Where the median is too narrow to accommodate a lane for left-turning vehicles and the traffic volumes and/or speeds are relatively high.
- Where vehicles are using a through traffic lane to turn left and slow down or stop, increasing the potential for rear-end collisions.
- In urban or heavily developed residential or commercial areas where vehicles turn left at an uncontrolled access point.
- In residential and commercial areas where a left-turn at the desired access point is not feasible.

Chapter 9 of the 2018 AASHTO GDHS shows several options that may be considered for indirect left-turns on high-speed/high-volume highways.

A U-turn design should look closely at intersection spacing, access conflicts, and the amount of room available to accommodate the largest design vehicle expected to make the U-turn. U-turns should not be permitted from the through lanes. The width of the highway, including the median, should be sufficient to permit the design vehicle to turn from an auxiliary left-turn lane in the median into the lane next to the outside shoulder or outside curb and gutter on the opposing traffic lanes.

8.15.2 Intersections with Jug Handle or Loop Roadways

Refer to the 2018 AASHTO GDHS Chapter 9, Section 9.2.

8.15.3 Displaced Left-Turn Intersections

Refer to the 2018 AASHTO GDHS Chapter 9, Section 9.3.

8.15.4 Wide Medians with U-Turn Crossover Roadways

Refer to the 2018 AASHTO GDHS Chapter 9, Section 9.4.

8.15.5 Location and Design of U-Turn Median Openings

Refer to the 2018 AASHTO GDHS Chapter 9, Section 9.5.

8.16 Right-Turn Lanes

8.16.1 General Design Considerations

Minor intersections that are skewed and all major intersections require separate right-turn lanes. Design of right-turn lanes is similar to that of left-turn lanes.

A right-turn lane can fulfill one or more of the following functions:

- A means of safe deceleration outside the high-speed through lanes for right-turning traffic.
- A storage area for right-turning vehicles to assist in optimization of traffic signal phasing.
- A means of separating right-turning vehicles from other traffic at stop-controlled intersection approaches.



Bicycle facilities sometimes share the right-turn lane with vehicles. A common crash type results from vehicles making right-turns cutting off bicyclists. Dashed green bike markings approaching an intersection can improve driver awareness that there may be bicycles in the right-turn lane. At signalized intersections in urban areas, a “no right-turn on red” phase could help to prevent this type of bicycle crash.

Refer to Chapter 13 and the NACTO Urban Bikeway Design Guide (NACTO, 2014).

8.16.2 Tapers

Auxiliary lane tapers help to build a transition to right- and left-turn lanes at intersecting roadways. The length and type of taper is dependent upon the facility type it is serving (Road, Street, or Freeway), and if the turn lane will be a stop condition, merge condition, or free-flow condition to the adjacent facility. The designer needs to consider the traffic volumes this lane serves and provide sufficient storage length after the taper depending on the stop condition at the intersection to avoid traffic queuing back into the travel lanes.

8.16.2.1 Taper Length

Refer to the 2018 AASHTO GDHS Chapter 9, Section 7.2.3.

8.16.3 Storage

Design for storage at signalized intersections is based on arrival rates for right-turn volumes and departure conditions (i.e., available green time, cycle length). In designing for storage, the adjacent through lane volume will often control the desirable length because:

- Right-turn lanes have greater capacity due to greater signal timing flexibility.
- There is potential for right-turn on red movements.



For further information, refer to the *Highway Capacity Manual* (TRB, 2022).

8.16.4 Length

Right-turn lanes at stopped approaches should be of sufficient length to enable right-turning vehicles to bypass queued through lane or left-turning vehicles. This allows the higher capacity right-turn movement to operate independently of other stopped movements.

The required length for a right-turn lane is calculated in the same manner as described in Section 8.12.2 of this Guide. Signal timing, pedestrian activity, and vehicle arrival patterns are the most important aspects to consider when designing the length. Normally, a minimum storage length of 100 feet should be provided in addition to the taper.

8.16.5 Width

Lane width requirements for right-turn lanes are similar to those for other lanes. In general, 12-foot lanes are desirable, although widths as low as 10 feet have been used in severely constrained situations unless large trucks and buses are using the lane.

The width of a separate right-turning lane shall normally provide at least one-way one-lane operation with passing permitted. In some cases, it may be necessary to provide one-way two-lane operation; additional shoulder width for emergency parking under this condition is usually not required. When two-lane operation is required, the maximum desirable turning radius should be 200 feet.

Right-turn lanes adjacent to barrier curbs should be designed to full widths to negate the constricting effects of a curb. This is particularly important if the gutter width dimension is nominal.

It may be necessary, for example, to relocate a bus stop to midblock or to the far side if a right-turn lane is introduced.

8.16.6 Shoulders

Refer to Section 8.5.1.1 of this chapter.

8.17 Intersection Design Elements with Frontage Roads

Frontage roads are generally required contiguous to arterials or freeways where adjacent property owners are not permitted direct access to their property. Short lengths of frontage roads may be used along urban arterials to preserve the capacity and safety of the arterial through access control.

Where an arterial is flanked by two frontage roads, the roadway design and traffic control at intersections become more complex. There are actually three intersections at each cross street (two, if there is only one frontage road). A hazard is introduced with the increase in the number of conflicting movements at the intersection of the frontage road(s) and the arterial and from the confusing pattern of roadways and separations, which can lead to wrong-way entry.



For satisfactory operation with moderate-to-heavy traffic volumes on the frontage roads, the outer separation should preferably be 150 feet or more in width at the intersection. A thorough discussion of the separation of main line and frontage road is discussed in Chapter 9 of the 2018 AASHTO GDHS.

8.18 Traffic Control Devices

Determination of the type and use of traffic control devices for intersections of various types is defined by the Manual on Uniform Traffic Control Devices. This includes markings, signing, traffic signals, and delineation to name a few.



Use the following link to access FHWA's Manual on Uniform Traffic Control Devices (MUTCD): <https://mutcd.fhwa.dot.gov/>

8.19 Bicycles at Intersections

When on-street bicycle lanes and/or off-street bicycle paths enter an intersection, the intersection design should be modified accordingly. Further guidance in accommodating bicycles at intersections can be found in Chapter 13 of this Guide, the AASHTO *Guide for Development of Bicycle Facilities* (AASHTO, 2012), and the NACTO *Urban Bikeway Design Guide* (NACTO, 2014).

8.20 Lighting at Intersections

Lighting can enhance the safety at intersections, as well as efficiency of intersection traffic operations. Statistics indicate that the non-daylight crash rate is higher than that during daylight hours. This fact, to a large degree, may be attributed to impaired visibility.

In urban and suburban areas where there are concentrations of pedestrians and roadside and intersectional interferences, fixed-source lighting tends to reduce crashes. The need for lighting of rural at grade intersections depends on the planned geometrics and the turning volumes. Intersections that generally do not require channelization are seldom lighted. However, for the benefit of non-local highway users, lighting at rural intersections is desirable to aid the driver in ascertaining sign messages during non-daylight hours. Refer to Section 3.7 of this Guide.

Intersections with channelization, particularly multiple road geometrics, should include lighting. Large, channelized intersections especially need illumination because of the higher range of turning radii that are not within the lateral range of vehicular headlight beams. Vehicles approaching the intersection also must reduce speed. The indication of this need should be definite and visible at a distance from the intersection that may be beyond the range of headlights. Illumination of at-grade intersections with fixed-source lighting fulfills this need.

The location of intersection luminaire supports should be where it presents the least possible hazard to out-of-control vehicles. Refer to the AASHTO *Roadside Design Guide* (AASHTO, 2011) for further design guidance.



Use this link for research on luminaire recommendations for pedestrians:
<https://apps.ict.illinois.edu/projects/getfile.asp?id=9812>

8.21 Driveways

A driveway is, in effect, an at-grade intersection and should be designed consistent with its intended use. Depending upon the traffic generation of access, auxiliary turn lanes or a TWLTL maybe needed to safely serve the traffic demand. Refer to Section 9.11.6 in the 2018 AASHTO GDHS.

The regulation and design of driveways are intimately linked with the right of way and zoning of the roadside. On new facilities, during right of way acquisition, access control can be negotiated and secured, to provide the desired degree of driveway regulation and control. Additional right of way and access control can be acquired on existing highways, or access agreements can be completed with local agencies to improve existing undesirable access conditions. Often, the desired degree of access control may be subject to the police powers for state highway purposes as stated in the State Highway Access Code (State of Colorado, 2002), to require permits for all new driveways or change in land use of properties.

A designer should coordinate with the following people: Region Right of Way Manager, Region Access Program Manager, Region Traffic Engineer or local agency traffic engineer if access changes are being considered on a project. Refer to CDOT Standard Plans - M & S Standards (CDOT, 2019) and the State Highway Access Code (State of Colorado, 2002) for design information on driveways.

8.22 Railroad-Highway Grade Crossings

A railroad-highway crossing is typically at grade. The horizontal and vertical geometrics of a highway approaching an at-grade railroad crossing should be designed so that they do not divert a driver's attention from roadway conditions. It is advisable to coordinate early and often with the CDOT Region utilities engineer, Public Utilities Commission (PUC) Chief of Rail/Transit Safety, and the railroad companies to accommodate their specific regulations.

Ideally highway rail grade crossings should be aligned as close to a 90-degree skew to improve driver visibility to see oncoming trains, to facilitate safer crossings for bicyclists, and to provide sufficient advance stopping sight distance for the driver to see rail signal crossing activations if present. For further information on railroad crossings, refer to the 2018 AASHTO GDHS.