

# LAB 9 - Modifying Templates

This lab demonstrates how to modify existing templates by changing point constraints, deleting existing components and adding new ones.

## Chapter Objectives:

- Modify pavement lift thickness.
- Add a sub-base component to the template.
- Add an additional lane to one side of a template.
- Add a median barrier to a divided highway template.

Before beginning this lab, verify that the following files are loaded:

- C:\Projects\12345\Design\Drawings\Reference\_Files\12345DES\_Model.dgn
- C:\Workspace\Workspace-CDOT\_V8i\Standards-Global\InRoads\Preferences\CDOT\_Civil.xin
- C:\Projects\12345\Design\InRoads\DES12345\_Templates.itl (This file was modified in Lab 1)

## Lab 9.1 - Modify pavement lift thickness

This exercise demonstrates how to modify point constraints in order to change the lift thickness on an existing template. The HMA\_Crowned\_B10 template from the template library will be modified so that the bottom lift of asphalt will be 4 inches thick.

1. Open the **Create Template** dialog box.
2. <D> <D> on the root folder and expand the **1- Templates** folder.
3. <D> <D> on the **HMA\_Crowned\_B10** template.
4. <D> <D> on the **ABC\_Centerline-Top** point to display the Point Properties dialog box.

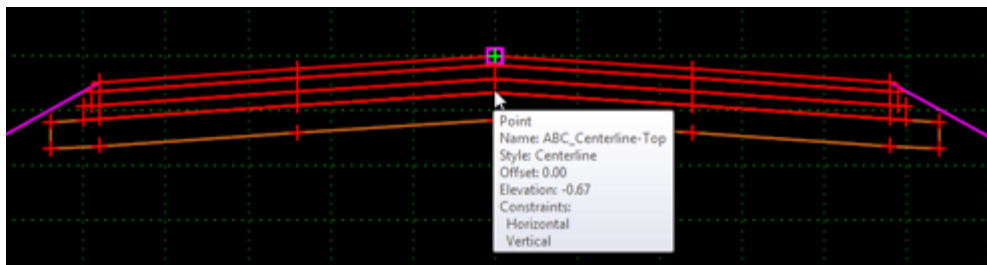

5. Key in **-0.33** for the **Value** of the **Vertical** constraint.
6. <D> **Apply**.

7. <D> Close.

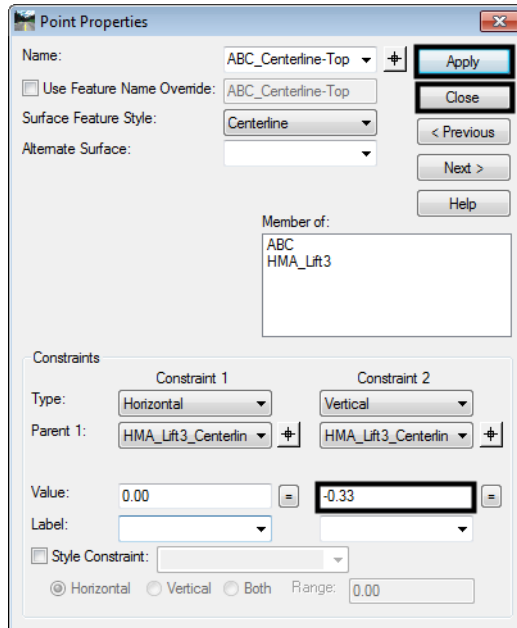

8. Repeat steps 4 through 7 for the following points:

- ◆ RT\_ABC\_Laneline-Top
- ◆ RT\_ABC\_Hinge-Top
- ◆ LT\_ABC\_Laneline-Top
- ◆ LT\_ABC\_Hinge-Top

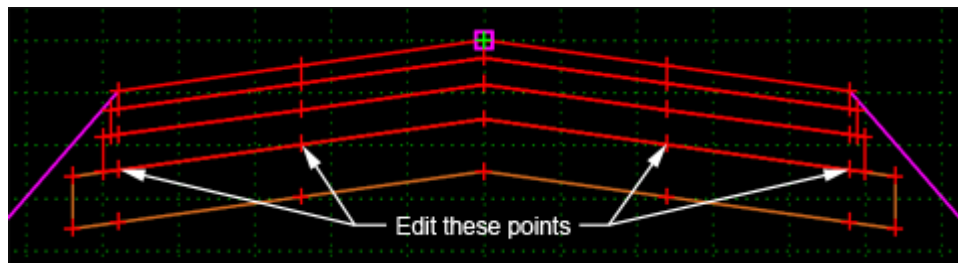

**Note:** The two outside points (HMA\_Lift3\_EOP-Bottom and ABC\_EOP-Top) do not need to be modified. This is because they are built with Vector/Offset constraints which keeps them in line with the other points on that row.

## Lab 9.2 - Add a sub-base component to the template

This exercise show how to add and modify a component to an existing template in order to add a sub-base component to the bottom of the HMA\_Crowned\_B10 template used above. The sub-base will be added as a new component instead of using one from the library in order to minimize the amount of editing.

1. <D> <D> on the **HMA\_Crowned\_B10** template (if it is not already displayed).

2. <R> in the template view and select **New Component > Constrained** from the menu.

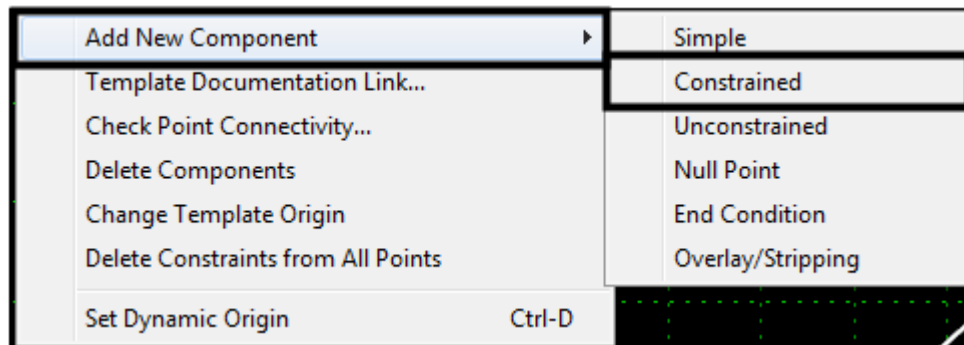

3. Key in **SubBase\_2 ft** in the **Name** field.
4. Set the **Style** to **D\_SUBBASE**.

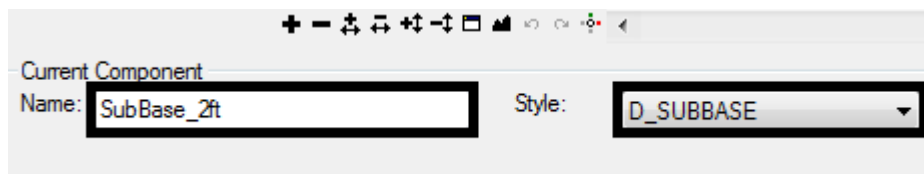

5. Starting at the left, <D> on the points across the bottom of the ABC component.
6. After placing the first point, <R> and verify that **Closed Shape** is checked on.

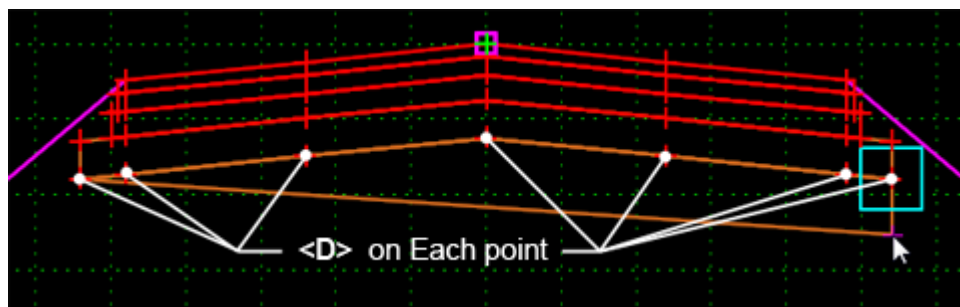

The next steps build the bottom of the subbase. The points are placed in the approximate location. Their final position is set by editing the point constraints.

7. Place a point approximately below each of the points just entered, working back from right to left.
8. <R> in the template view and select **Finish** from the menu.
9. <D> <D> on the lower left corner of the new sub-base component.
10. In the **Point Properties** dialog box, change the **Name** to **LT\_SubBase\_EOP-Bottom**.

**Note:** The name is the same as the point above it, except that the word Top is replaced with the word Bottom.

11. Set the **Parent 1** for both constraints to the point directly above (in this case **LT\_SubBase\_EOP-Top**).
12. Key in **0** for the **Horizontal** constraint value.
13. Key in **-2** for the **Vertical** constraint value.
14. **<D> Apply**.
15. **<D> Close**.

The screenshot shows the 'Point Properties' dialog box. The 'Name' field is 'LT\_SubBase\_EOP-E'. The 'Use Feature Name Override' checkbox is unchecked, with a value of '6'. The 'Surface Feature Style' is 'D\_EOP'. The 'Alternate Surface' is empty. The 'Member of' field is 'SubBase\_2 ft'. The 'Constraints' section is expanded, showing two constraints: 'Constraint 1' (Horizontal) with a value of '0.00' and 'Constraint 2' (Vertical) with a value of '-2.00'. Both constraints have their 'Parent 1' set to 'LT\_SubBase\_EOP-1'. The 'Style Constraint' checkbox is unchecked. The 'Range' is '0.00'. Buttons for 'Apply', 'Close', '< Previous', 'Next >', and 'Help' are visible.

16. Repeat steps 8 through 14 for the remaining points across the bottom of the sub-base component.

The finished template is illustrated below:

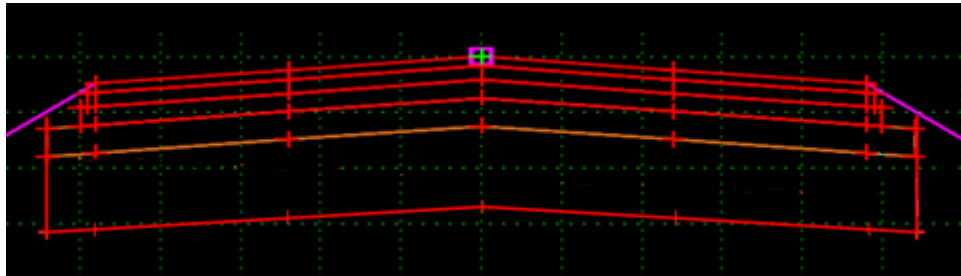

## Lab 9.3 - Add an Additional Lane to One Side of a Template

This exercise demonstrates how to add new components to an existing template in order to add an additional travel lane. Using the template `HMA_Urban_4Lane` from the template library, the right curb, ABC, and End Conditions will be deleted and a new lane with curb and gutter will be added.

1. <D> <D> on the `HMA_Urban_4Lane` template.
2. Toggle on **Display All Components**.

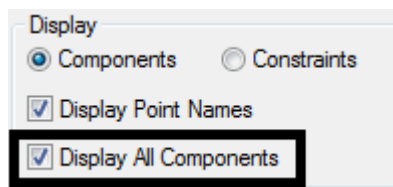

Affixes are used so that point names added to the template are updated to reflect their location with respect to the control line.

3. Select **Tools > Options** from the *Create Template* menu bar.
4. Toggle on **Apply Affixes**.

5. <D> OK.

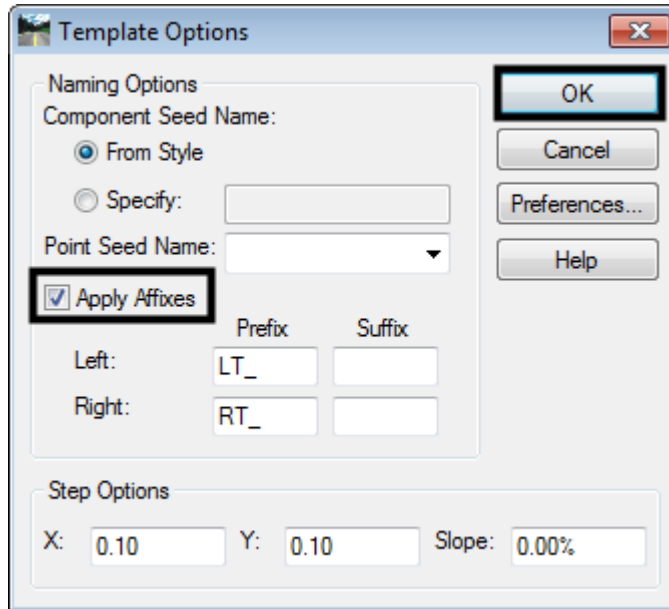

The existing curb and gutter on the right side of the template and its ABC component must be removed from the template to make room for the new lane.

6. <R> in the template view and select **Delete Components** from the menu.

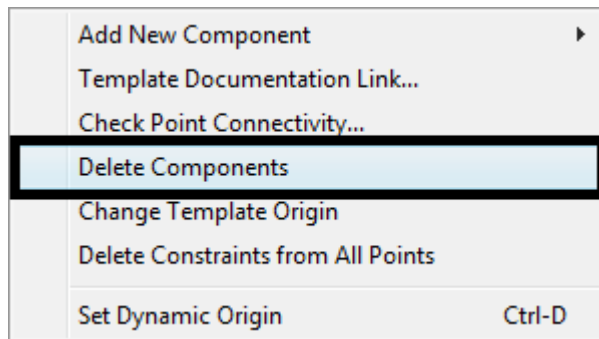

7. **<D> and hold**, then draw a line through the curb, sub-base, and end conditions components on the right side of the template as shown below. Release the mouse button to complete the delete.

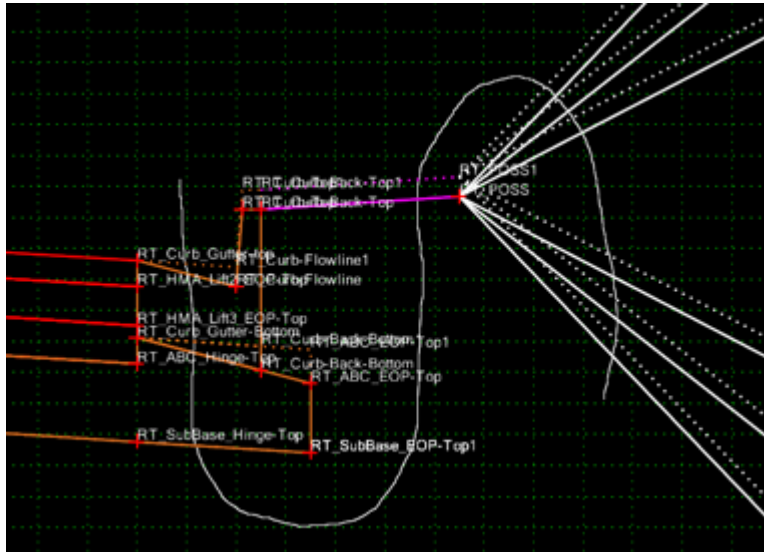

The exposed points still have names used by the curb and gutter component. These must be changed to reflect the new role of the point.

8. Rename the points at the right end of the template as follows:
- ***RT\_HMA\_Lift1\_Laneline-Top1***
  - ***RT\_HMA\_Lift2\_Laneline-Top1***
  - ***RT\_HMA\_Lift3\_Laneline-Top1***
  - ***RT\_ABC\_Laneline-Top1***

The template library contains a three lift asphalt driving lane section with curb and gutter attached. Use this section to complete the backbone of the template.

9. Expand the **2 – Sections - Pavement > Curb & Gutter Sections** folder in the template library explorer.
10. **<D>** on the **C/G\_Type2-IIB** section.
11. **<D> and Hold** on the section's origin in the **Preview** window.

12. Drag and Drop the section onto the **RT\_HMA\_Lift1\_Laneline-Top1** point.

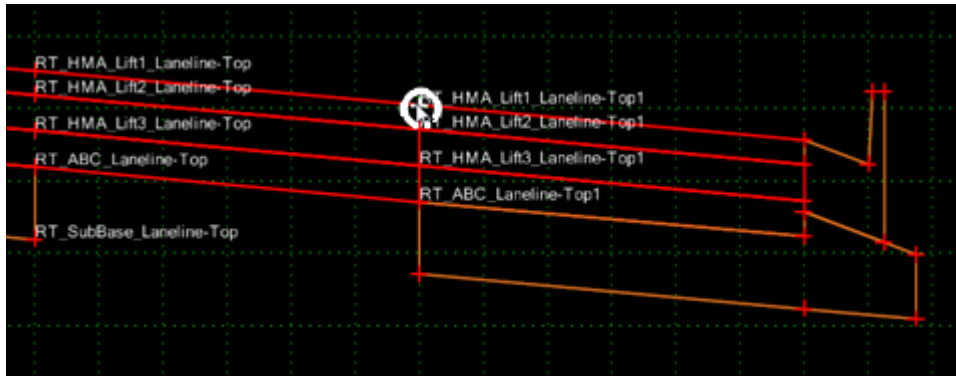

The new section that was added accommodates a design decision on when to generate a gutter with a normal slope and when to generate the gutter with a slope to match the driving lanes. This section has two curb components. Therefore, two end condition sections are required, one attached to each curb. These next steps show how to modify the criteria for the design decision.

13. Zoom in on the right curb components, there are two (one is shown with dotted lines).
14. **<D>** **<D>** on the **RT\_Curb\_Gutter-top** point.
15. Change the **Slope** constraint **Value** to **5.00%**. This is done so that hidden (dotted) curb component is displayed. It will also allow the points to merge as desired in the following steps.

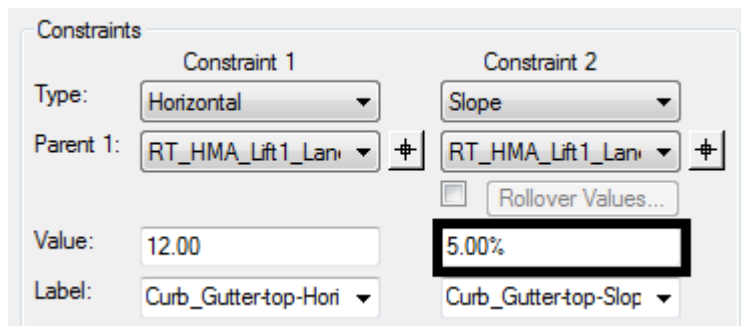

16. **<D>** **Apply**.



17. <D> Close.

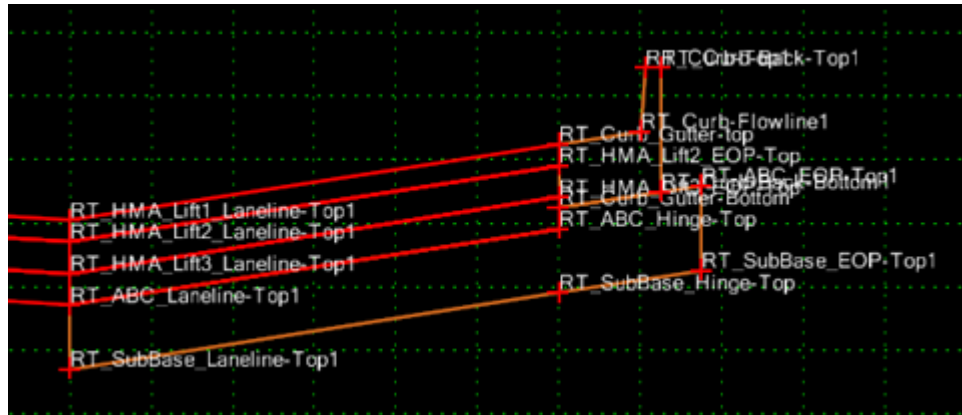

18. Expand the **3 – Sections End Conditions > Curb & Gutter Sections** folder in the template library explorer.
19. <D> on the **Bench\_4\_6\_to\_1** section to display it in the Preview window.
20. <D> and Hold on the section's origin in the **Preview** window.
21. Drag and Drop the section on to the **RT\_Curb\_Back-Top1** point.

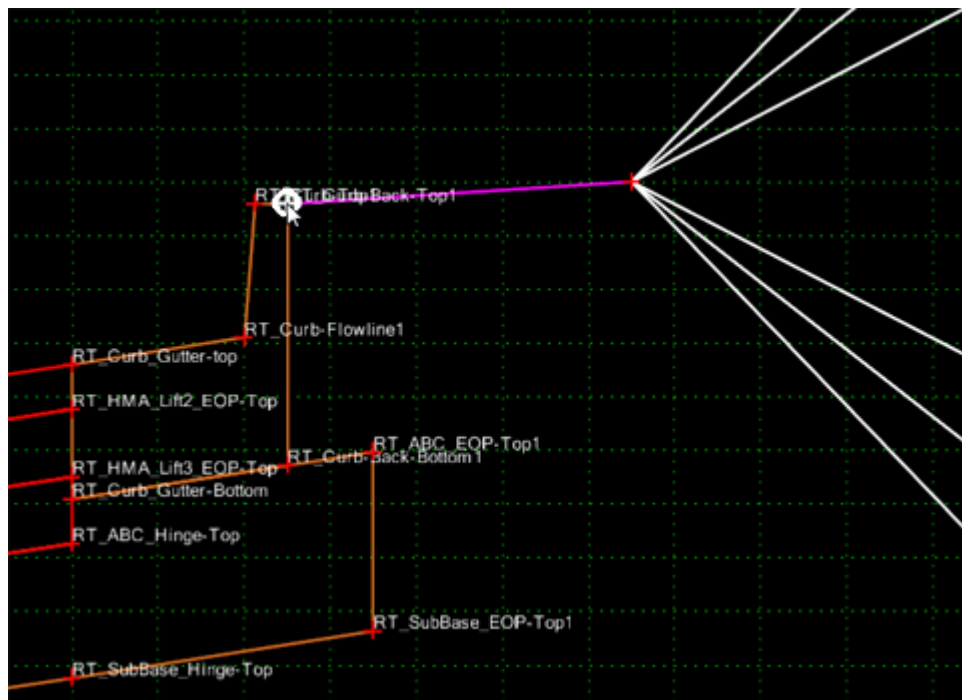

22. <D> <D> on the **RT\_Benching** component that was just placed.
23. Set the **Parent Component** to **RT\_C/G\_Type2-IIB1**.
24. <D> Apply.

25. <D> Close.

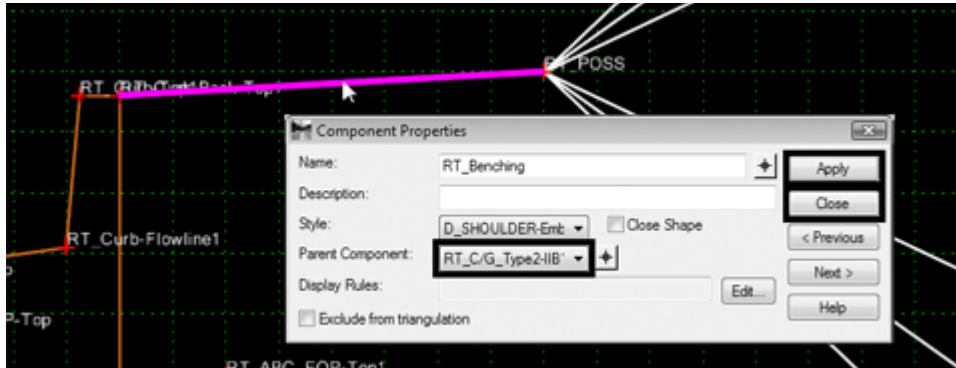

26. <D> <D> on the **RT\_Curb\_Gutter-top** point.
27. Change the **Slope** constraint **Value** to **-2.00%**. This is done so that the hidden (dotted) curb component is displayed. It will also allow the points to merge as desired in the following steps.
28. <D> Apply.
29. <D> Close.
30. <D> and Hold on the **Bench\_4\_6\_to\_1** section's origin in the **Preview** window.
31. **Drag and Drop** the section on to the **RT\_Curb\_Back-Top** point.

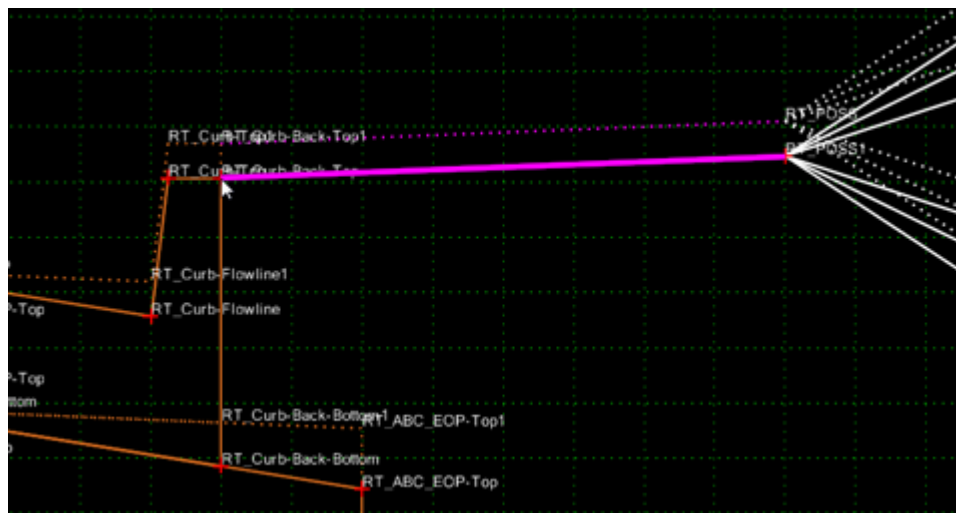

32. <D> <D> on the **RT\_Benching1** component that was just placed.
33. Set the **Parent Component** to **RT\_C/G\_Type2-IIB**.
34. <D> Apply.
35. <D> Close.

**Note:** Applying the Parent Component settings to the Benching components will make the proper end condition display based on the pavement cross slope.

Finally, the missing ABC component is added under the new driving lane.

36. Expand the **4 - Components > Aggregate Bases > Driving Lanes** folder in the template library explorer.
37. **<D>** on the **ABC\_Lane** component to display it in the Preview window.
38. **<D> and Hold** on the section's origin in the **Preview** window.
39. **Drag and Drop** the section on to the **RT\_ABC\_Laneline-Top** point.

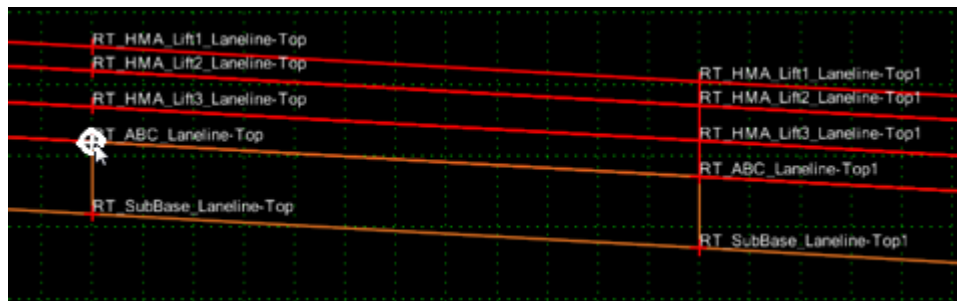

40. **<R>** on the vertical line between **RT\_ABC\_Laneline-Top** and **RT\_SubBase\_Laneline-Top** and select **Merge Components** from the menu.

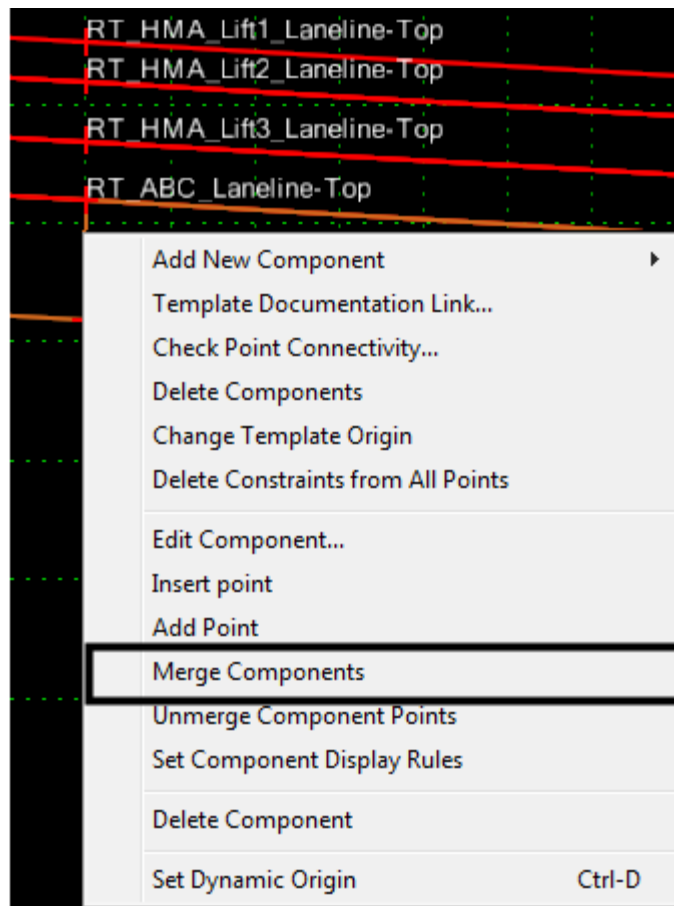

The finished template is illustrated below:

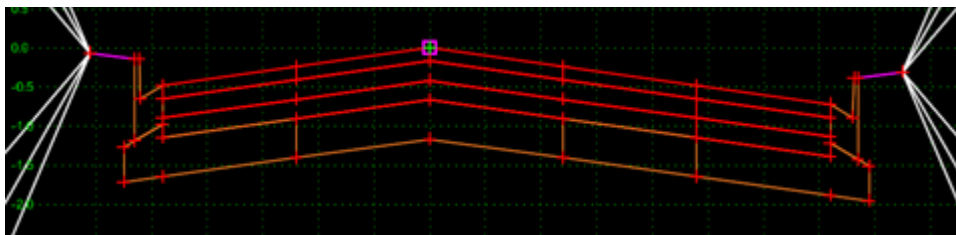

## Lab 9.4 - Add a Median Barrier to a Divided Highway Template

In order to add a median barrier to the **CONC\_Divided\_TypeA\_4Lane** template, the slope components will be deleted, the ABC components will be modified, a **Guardrail\_Type 7-CE** component will be added, and the pavements will be tied to the barrier.

To start the process, the points that define the median ditch are deleted, removing the ditch from the template.

1. **<D> <D>** on the **CONC\_Divided\_TypeA\_4Lane** template.

2. <R> on the **RT\_Median\_POSS** point and select **Delete Point**.

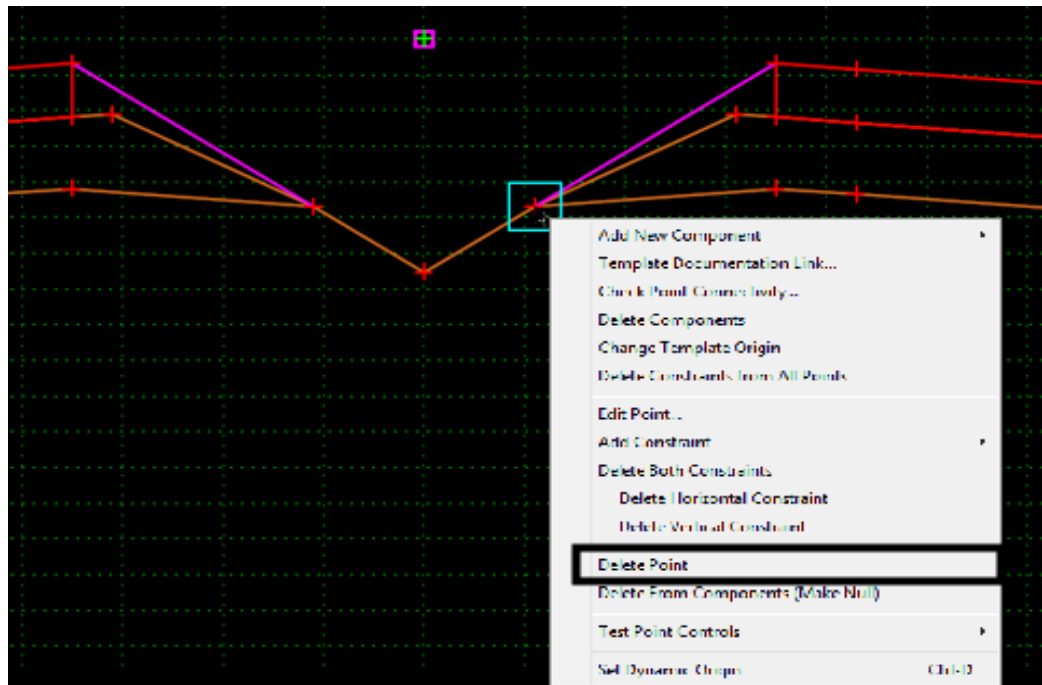

3. In the **Delete Point** dialog box, <D> **All**.
4. <D> **OK**. This deletes the point from **RT\_SubBase\_Shoulder** and deletes the **Z-Slope\_12\_6\_to\_12** and **RT\_Median** components.
5. <R> on the **RT\_Inside\_SubBase\_EOP-Top2** point and select **Delete Point**.
6. Using the same method as the steps above, delete the following points:
  - ◆ LT\_Median\_POSS
  - ◆ LT\_SubBase\_EOP-Top
  - ◆ Median\_Flowline

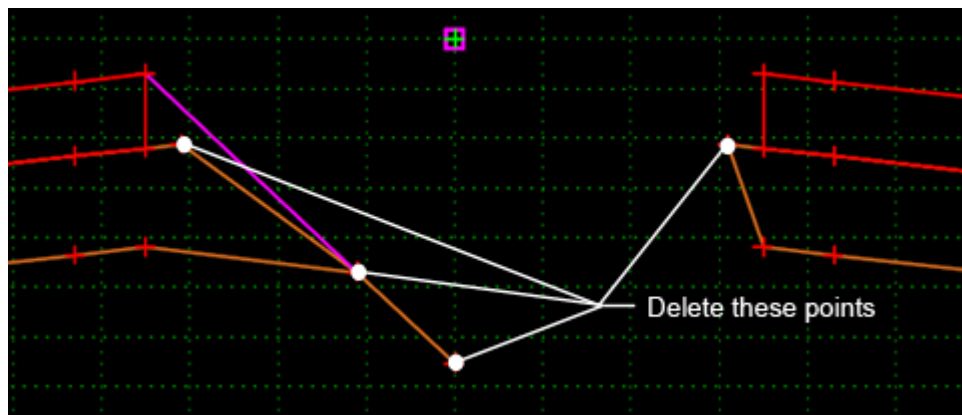

Place a Type-7 barrier in the template. In this case, the center bottom of the barrier is placed on the template origin.

7. Toggle off **Apply Affixes** (either on the *Dynamic Settings* dialog or from *Tools > Options*).
8. Expand the **4 – Components > Barriers & Misc Components > Guardrail Type 7** folder in the template library explorer.
9. **<D>** on the **Guardrail\_Type 7-CE** component to highlight it; do not make it active.
10. In the *Preview* window, **<D> and Hold** on the component's **Insertion Point** (The green + sign in the middle of the barrier).
11. **Drag and Drop** the component to the template's origin.

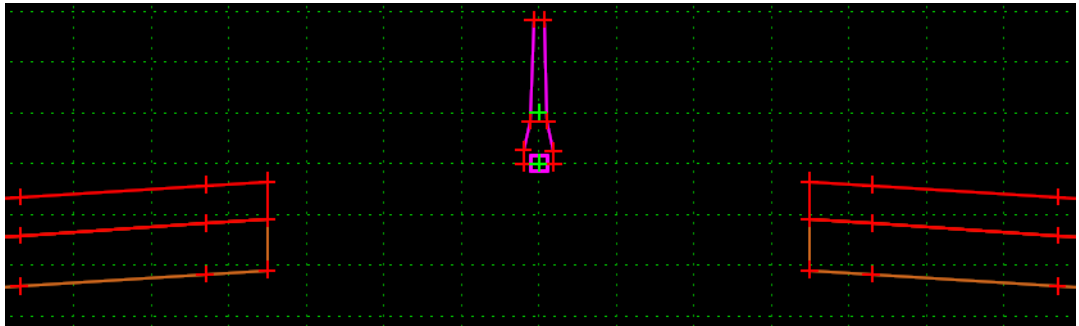

Now the pavement edges need to be attached to the barrier. This is done by modifying the constraints for the those points.

12. **<D> <D>** on the point **RT\_Inside\_Conc\_EOP-Top**.
13. Set the **Parent 1** for both constraints to **RT\_Connect**.
14. Key in **0** for the **Value** of both constraints.
15. **<D> Apply**.

## 16. &lt;D&gt; Close.

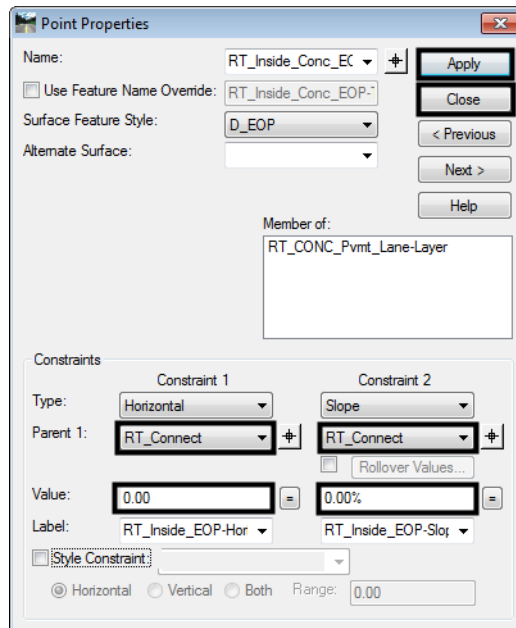
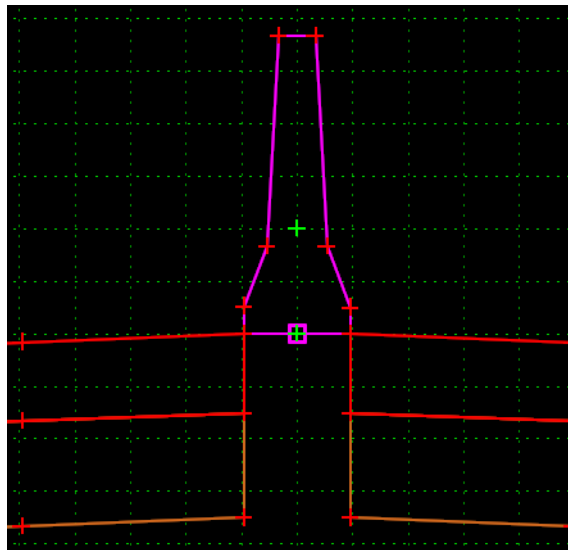
17. Repeat steps 12 through 15 for point **LT\_Inside\_Conc\_EOP-Top** using **LT\_Connect** as the **Parent 1** point.

## 18. Zoom in to the area under the barrier.

The next series of steps places a concrete component under the barrier. This component is placed independent of other points in the template. It is then constrained so that it will move with the barrier.

19. <R> and select **Add New Component > Unconstrained**.20. Key in **CONC\_Under\_Barrier** for the component **Name**.

21. Select **D\_CONC\_Pvmt** for the **Style**.

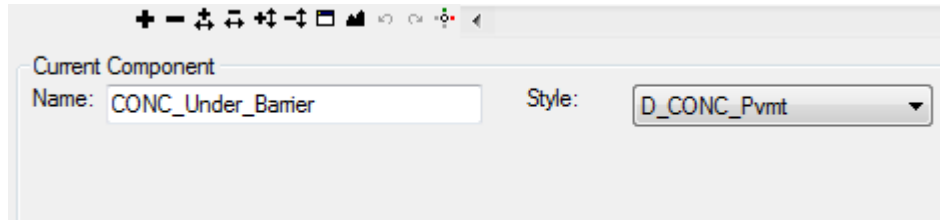

22. In the Dynamic Settings dialog box, key in **RT\_CONC\_Under\_Barrier-Top** for the **Point Name**.
23. **<D>** under the right edge of the barrier but not on any existing point or component.
24. In the Dynamic Settings dialog box, key in **RT\_ABC\_Under\_Barrier-Top** for the **Point Name**.
25. **<D>** below the **RT\_CONC\_Under\_Barrier-Top** point that was just placed.
26. In the Dynamic Settings dialog box, key in **LT\_ABC\_Under\_Barrier-Top** for the **Point Name**.
27. **<D>** to the left of the point that was just placed.
28. In the Dynamic Settings dialog box, key in **LT\_CONC\_Under\_Barrier-Top** for the **Point Name**.
29. **<D>** above the point that was just placed.
30. **<R>** and select **Finish**.

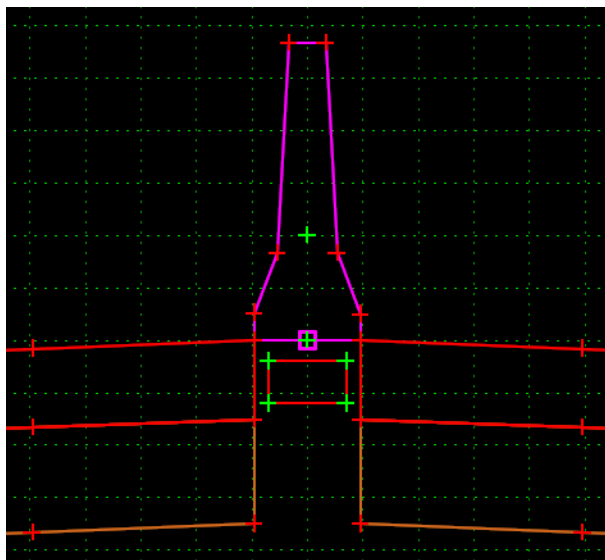

31. **<D> <D>** on the **RT\_CONC\_Under\_Barrier-Top** point.
32. Set the **Constraint 1 Type** to **Horizontal**.
33. Set the **Constraint 2 Type** to **Vertical**.



34. Set the **Constraint 1 Parent 1** to **RT\_Barrier-Bottom**.
35. Set the **Constraint 2 Parent 1** to **RT\_Barrier-Bottom**.
36. Key in **0** for the **Value** of both constraints.
37. **<D> Apply**.
38. **<D> Close**.

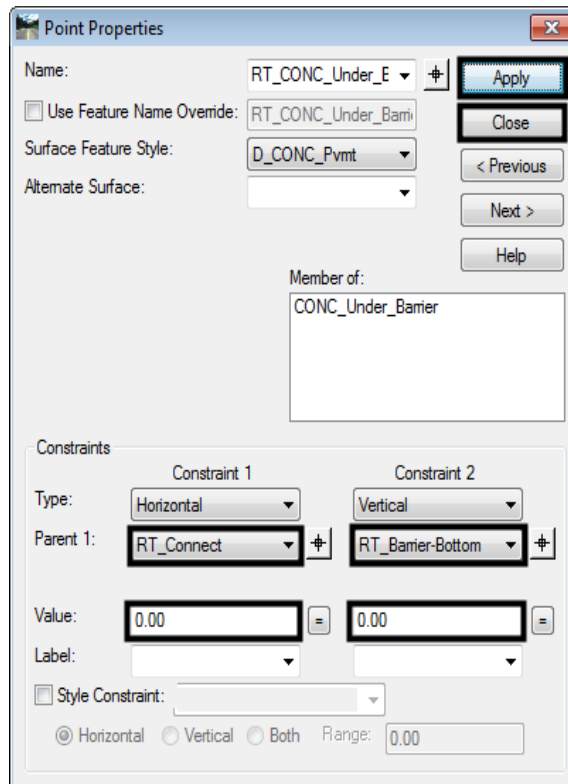

39. **<D> <D>** on the **LT\_CONC\_Under\_Barrier-Top** point.
40. Set the **Constraint 1 Type** to **Horizontal**.
41. Set the **Constraint 2 Type** to **Vertical**.
42. Set the **Constraint 1 Parent 1** to **LT\_Barrier-Bottom**.
43. Set the **Constraint 2 Parent 1** to **LT\_Barrier-Bottom**.
44. Key in **0** for the **Value** of both constraints.
45. **<D> Apply**.
46. **<D> Close**.
47. **<D> <D>** on the **RT\_ABC\_Under\_Barrier-Top** point.
48. Set the **Constraint 1 Type** to **Horizontal**.

49. Set the **Constraint 2 Type** to **Vertical**.
50. Set the **Parent 1** to **RT\_CONC\_Under\_Barrier-Top** for both constraints.
51. Key in **0** for the **Value** of the **Horizontal** constraint.
52. Key in **-0.75** for the **Value** of the **Vertical** constraint.
53. **<D> Apply**.
54. **<D> Close**.
55. **<D> <D>** on the **LT\_ABC\_Under\_Barrier-Top** point.
56. Set the **Constraint 1 Type** to **Horizontal**.
57. Set the **Constraint 2 Type** to **Vertical**.
58. Set the **Parent 1** to **LT\_CONC\_Under\_Barrier-Top** for both constraints.
59. Key in **0** for the **Value** of the **Horizontal** constraint.
60. Key in **-0.75** for the **Value** of the **Vertical** constraint.
61. **<D> Apply**.
62. **<D> Close**.

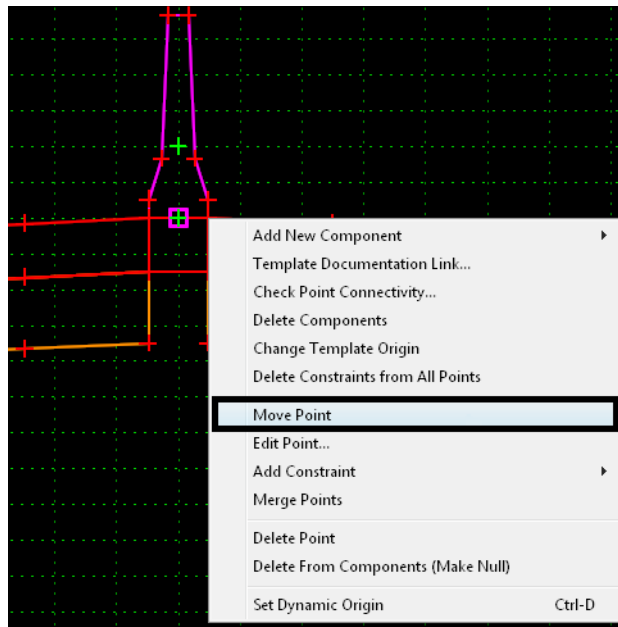

63. **<R>** on the **RT\_Connect** point and select **Move Point**.

64. **<D>** on **RT\_V\_Control** in the box that pops up listing all available points at this location.

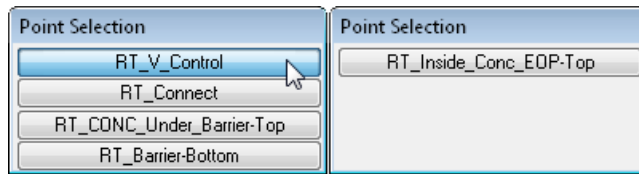

**Note:** If more than four points are available, **<ESC>** on your keyboard pages down in the list.

65. Move the pointer up and down and notice how the components behave.  
66. **<R>** to end the Move command

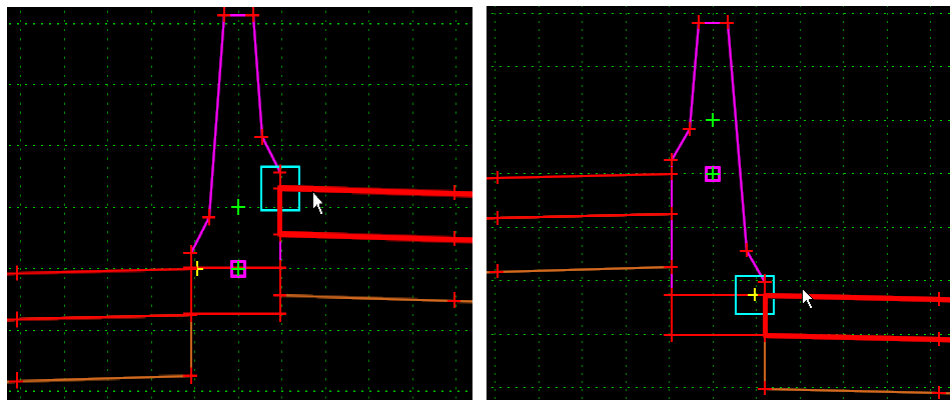

**Note:** This barrier has both a variable height *and* a variable width. If the height is 34" or less, the base is 23" wide. As the height increases above 34" the base varies from 23" to a maximum of 26.75". The maximum height is 40".

**Important!** Since the barrier width is variable, the adjacent shoulder, lanes, etc. are 'pushed out' as the barrier widens. A decision must be made if this is acceptable, or if you want another solution, such as varying the width of the shoulder to accommodate the widened barrier. If so, change the Parent of the Horizontal Constraint on the inside shoulder point to the V\_Control point. Since it does not widen with the barrier, the shoulder will be variable width. The maximum variation is 3.75".

An ABC component can be added under the barrier in a similar manner to the concrete component described above.

67. **<R>** and select **Add New Component > Unconstrained**.  
68. Key in **ABC\_Under\_Barrier** for the component **Name**.

69. Select **D\_ABC\_Class 6** for the **Style**.

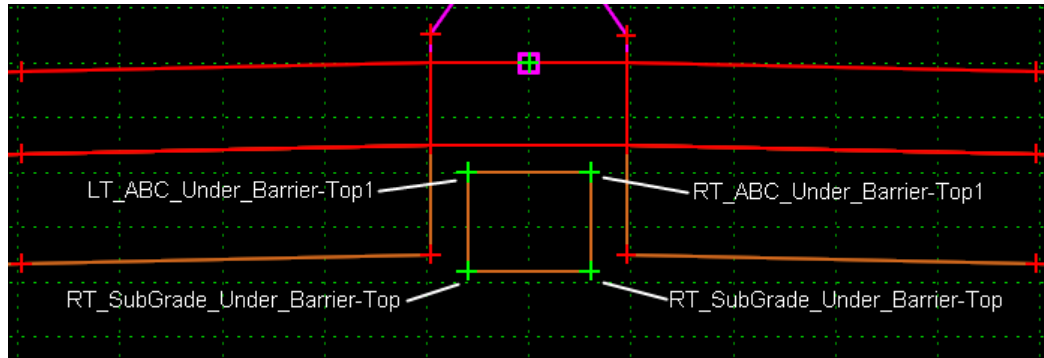

70. In the Dynamic Settings dialog box, key in **RT\_ ABC\_Under\_Barrier-Top1** for the **Point Name**.
71. **<D>** under the right edge of the component just added but not on any existing point or component.
72. Continue adding the other three points (as was done with the concrete component) Naming them:
- ◆ **RT\_ SubGrade\_Under\_Barrier-Top**
  - ◆ **LT\_ SubGrade\_Under\_Barrier-Top**
  - ◆ **LT\_ ABC\_Under\_Barrier-Top1**
73. **<R>** and select **Finish**.
74. **<D> <D>** on **RT\_ SubGrade\_Under\_Barrier-Top**.
75. Set the Parent 1 to **RT\_ ABC\_Under\_Barrier-Top1** on both constraints.
76. Key in **0** for the **Value** of the **Horizontal** constraint.
77. Key in **- 1.00** for the **Value** of the **Vertical** constraint.
78. **<D> Apply**.
79. **<D> Close**.
80. Repeat steps 71 through 76 for **LT\_ SubGrade\_Under\_Barrier-Top**, using **LT\_ ABC\_Under\_Barrier-Top1** as the **Parent 1** point.

81. <R> on the **RT\_ABC\_Under\_Barrier-Top1** point and select **Add Constraint > Full Constraint**.

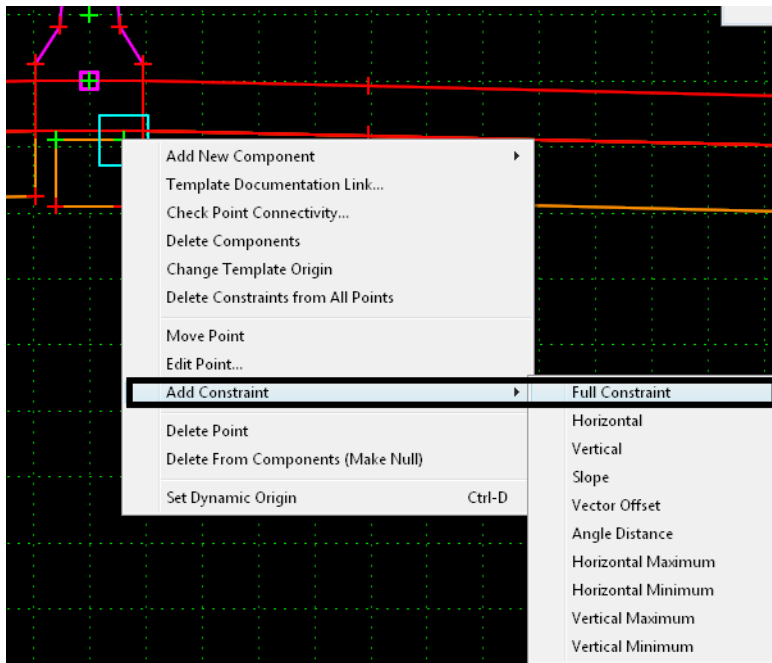

82. <D> on the **RT\_ABC\_Under\_Barrier-Top**.
83. <D> on **RT\_ABC\_Under\_Barrier-Top** on the **Point Selection** dialog box.

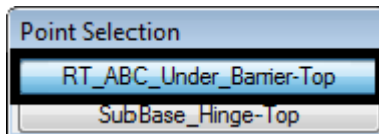

84. In the **Add Full Constraint** dialog box, key in **O** for both offsets.

85. <D> OK.

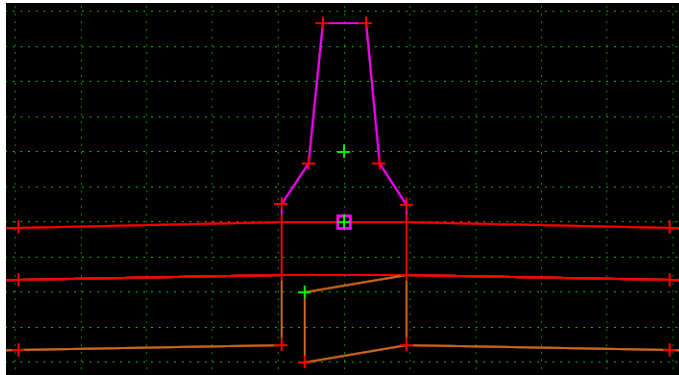
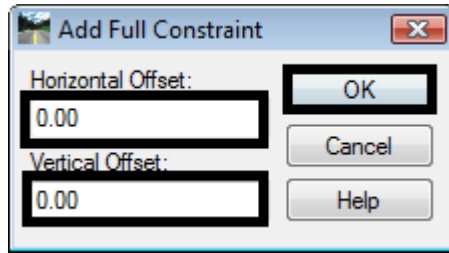

86. Repeat steps 79 through 82 for the point **LT\_ABC\_Under\_Barrier-Top1**, selecting point **LT\_ABC\_Under\_Barrier-Top** in the *Point Selection* dialog box.

The template is now completed.

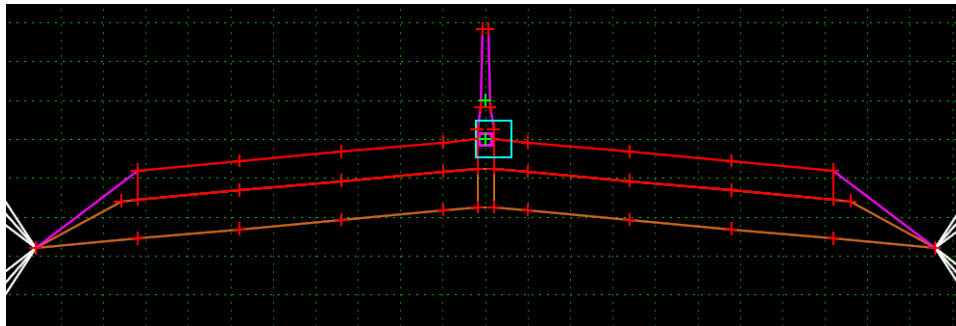

## Chapter Summary:

- In some cases, only minor alterations can change a standard template into a project specific one. In [Lab 9.1 -Modify pavement lift thickness](#) point constraints were changed to modify the thickness of a pavement lift.
- Other minor modifications include the addition of components. In [Lab 9.2 -Add a sub-base component to the template](#) a new component was created to add a sub-base component to the template.
- There are some case when major modifications can be made to an existing template. In [Lab 9.3 -Add an Additional Lane to One Side of a Template](#) components were deleted from an existing template and new components were added from the template library to add an additional lane to one side of a template.
- Editing a template does not always require deleting and/or adding whole components. Sometimes the desired results can be achieved working with the points on components. In [Lab 9.4 -Add a Median Barrier to a Divided Highway Template](#) components and specific component points were deleted, new components from the library and ones built from scratch were added and point constraints were modified to add a median barrier to a divided highway template.

