

**GENERAL NOTES**

- RUMBLE STRIPS SHALL BE OMITTED AT TURN AND AUXILIARY LANES, ROAD APPROACHES, RESIDENCES, 250 FT. BEFORE ROAD INTERSECTIONS, AND OTHER INTERRUPTIONS AS DIRECTED BY THE ENGINEER.
- RUMBLE STRIPS MAY BE INSTALLED BY GRINDING, ROLLING, OR FORMING ON CONCRETE PAVEMENT, AND BY GRINDING ONLY ON HMA PAVEMENT. RUMBLE STRIP WIDTH SHALL BE 12 IN. FOR GRIND-IN AND 18 IN. FOR FORMED OR ROLLED.
- MINIMIZE THE DISTANCE BETWEEN RUMBLE STRIP AND EDGE LINE ON CONCRETE PAVEMENTS WITH 14 FT. WIDE SLABS.
- BEGIN RUMBLE STRIPS ON THE OUTSIDE EDGE OF THE TRAVEL LANE EDGE LINE.
- DO NOT INSTALL RUMBLE STRIPS ON SHOULDERS LESS THAN 6 FT. WIDE WHEN GUARDRAIL IS PLACED ALONG THE EDGE OF THE SHOULDER.
- APPLY THE 60 FT. GAP PATTERN WHEN RUMBLE STRIPS (GRIND-IN) ARE INSTALLED IN CONCRETE PAVEMENT.

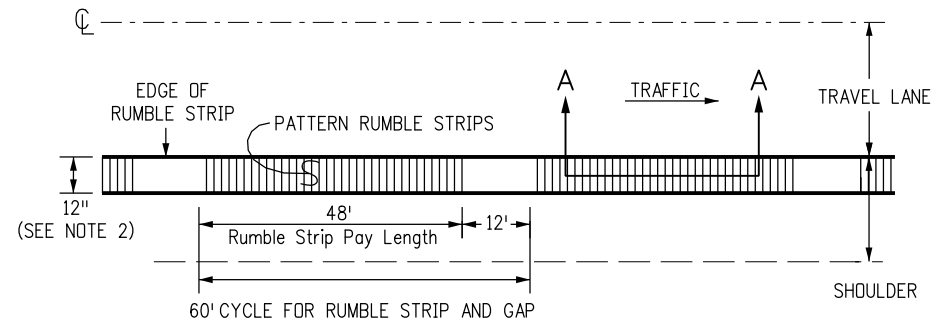

**INTERMITTENT RUMBLE STRIP  
TWO-LANE ROADWAY (HMA)**

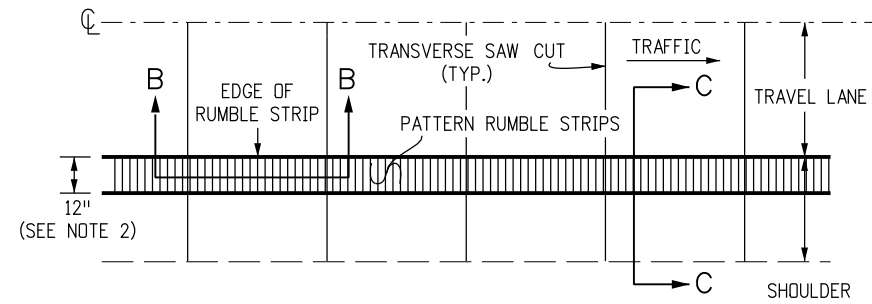

**CONTINUOUS RUMBLE STRIP  
TWO-LANE ROADWAY (CONCRETE)**

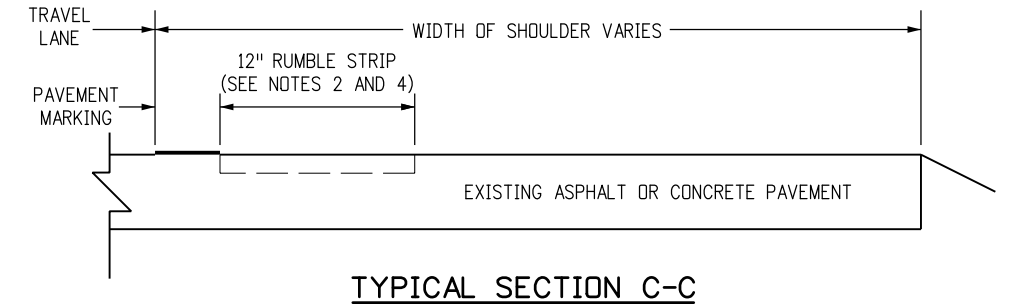

**TYPICAL SECTION C-C**

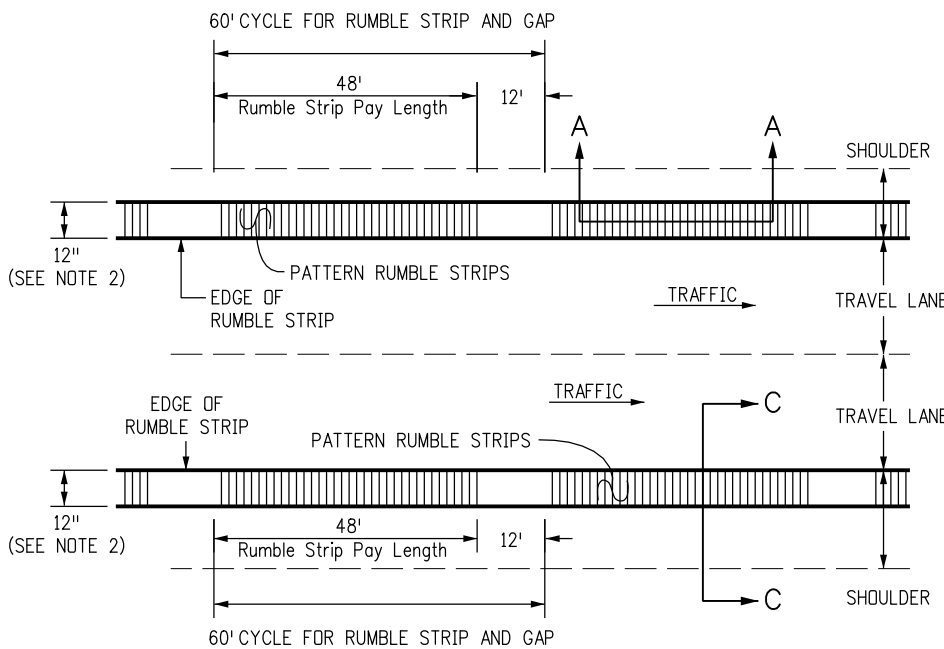

**INTERMITTENT RUMBLE STRIP  
FOUR-LANE DIVIDED ROADWAY (HMA)**

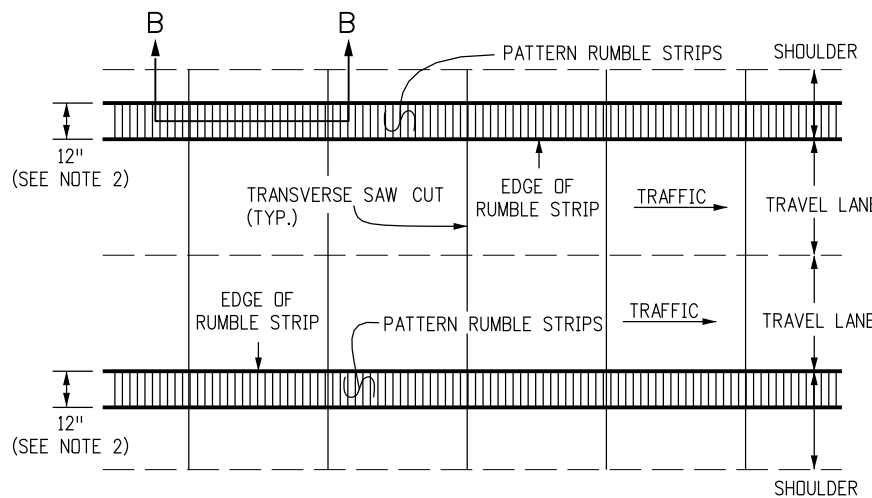

**CONTINUOUS RUMBLE STRIP  
FOUR-LANE DIVIDED ROADWAY (CONCRETE)**

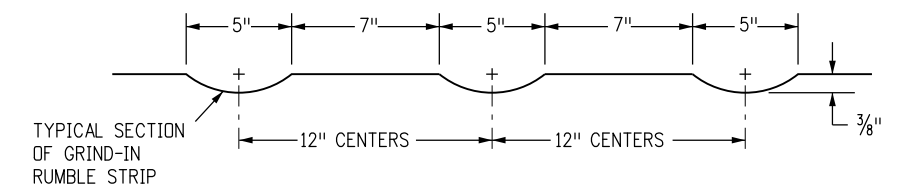

**TYPICAL SECTIONS A-A AND B-B  
FOR GRIND-IN RUMBLE STRIP  
ON EXISTING HMA OR CONCRETE PAVEMENT**

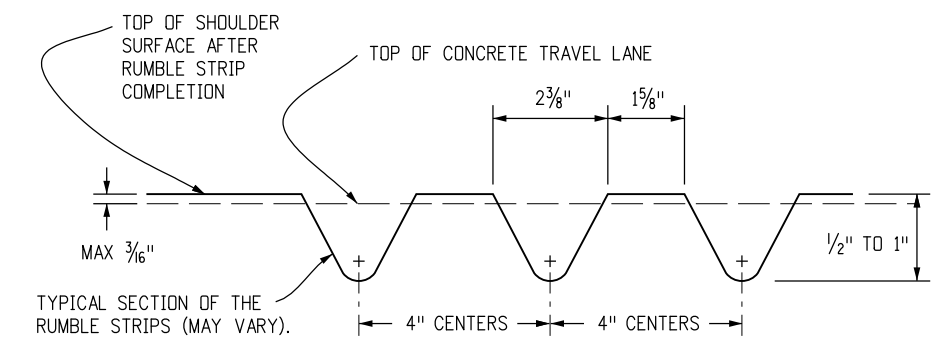

**TYPICAL SECTION B-B  
FOR FORMED OR ROLLED ON CONCRETE PAVEMENTS ONLY**

Computer File Information	
Creation Date: 07/04/12	Initials: JBK
Last Modification Date: 07/04/12	Initials: LTA
Full Path: www.codot.gov/business/designsupport	
Drawing File Name: 614010103.dgn	
CAD Ver.: MicroStation V8	Scale: Not to Scale Units: English

Sheet Revisions	
Date:	Comments
(R-X)	
(R-X)	
(R-X)	
(R-X)	

Colorado Department of Transportation

2829 West Howard Place  
 CDOT HQ, 3rd Floor  
 Denver, CO 80204  
 Phone: 303-757-9021 FAX: 303-757-9868

Division of Project Support      JBK/LTA

**RUMBLE STRIPS**

Issued By: Project Development Branch July 4, 2012

STANDARD PLAN NO.
M-614-1
Sheet No. 1 of 3

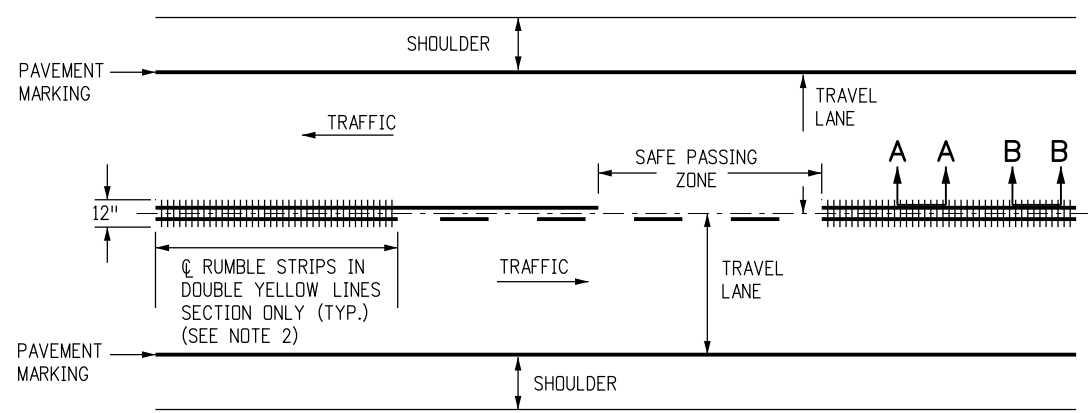

**TWO LANE HIGHWAY (HMA AND CONCRETE)  
CONTINUOUS CENTER LINE RUMBLE STRIPS**

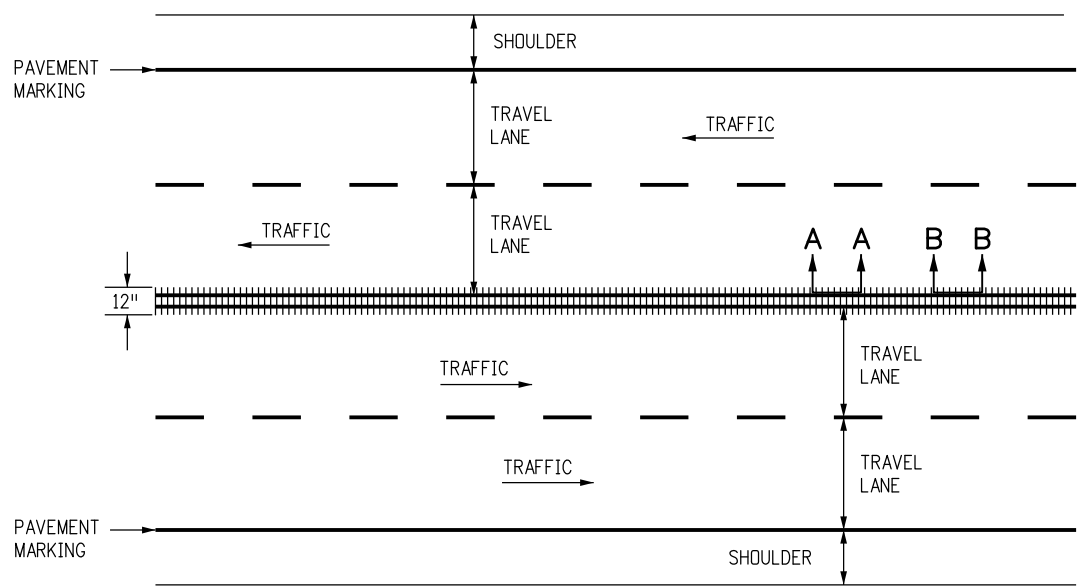

**FOUR LANE UNDIVIDED HIGHWAY (HMA AND CONCRETE)  
CONTINUOUS CENTER LINE RUMBLE STRIPS**

**NOTES**

1. RUMBLE STRIP WIDTH SHALL BE 12 IN. FOR GRIND-IN, FORMED, OR ROLLED.
2. CENTERLINE RUMBLE STRIPS MAY BE CONTINUOUS THROUGH PASSING ZONES AS DETERMINED BY THE ENGINEER AND SHOWN ON THE PLANS.

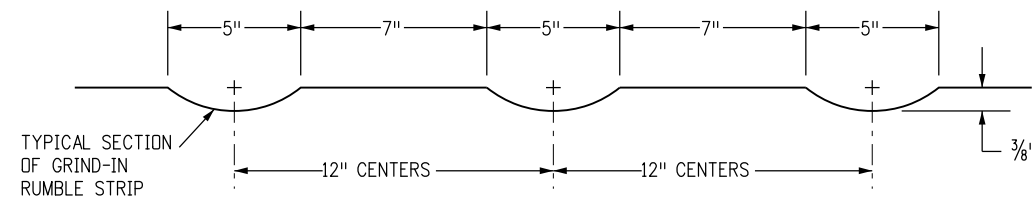

**TYPICAL SECTIONS A-A AND B-B**

FOR GRIND-IN RUMBLE STRIP  
ON EXISTING ASPHALT OR CONCRETE PAVEMENT

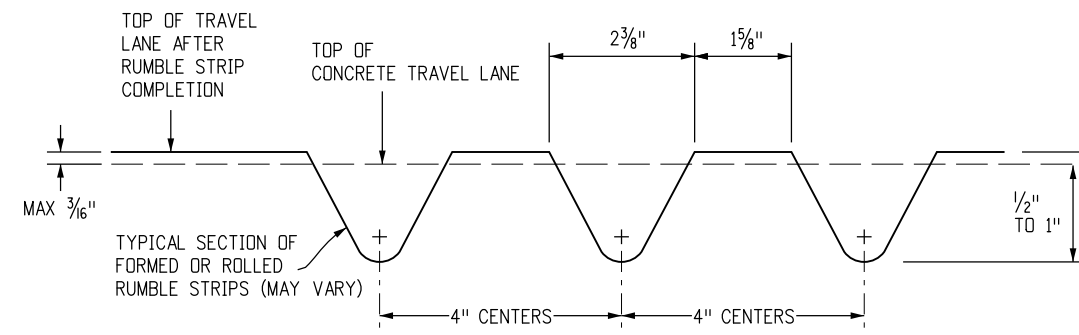

**TYPICAL SECTION B-B**

FOR FORMED OR ROLLED ON CONCRETE PAVEMENTS ONLY

**DETAILS FOR CENTER LINE RUMBLE STRIPS**

Computer File Information	
Creation Date: 07/04/12	Initials: JBK
Last Modification Date: 07/04/12	Initials: LTA
Full Path: www.codot.gov/business/designsupport	
Drawing File Name: 614010203.dgn	
CAD Ver.: MicroStation V8	Scale: Not to Scale Units: English

Sheet Revisions	
Date:	Comments
(R-X)	
(R-X)	
(R-X)	
(R-X)	

Colorado Department of Transportation



2829 West Howard Place  
CDOT HQ, 3rd Floor  
Denver, CO 80204  
Phone: 303-757-9021 FAX: 303-757-9868

Division of Project Support **JBK/LTA**

**RUMBLE STRIPS**

Issued By: Project Development Branch July 4, 2012

STANDARD PLAN NO.
M-614-1
Sheet No. 2 of 3

**NOTES**

1. GROOVED RUMBLE STRIP SKEW OR CLUSTER SPACING SHALL BE MODIFIED TO AVOID LOCATING A GROOVE ON A CONCRETE PAVEMENT TRANSVERSE JOINT.
2. PERMANENT TRAVEL LANE RUMBLE STRIPS SHALL BE THE GROOVE DESIGN, AND MAY BE CUT IN EXISTING, NEW HMA, OR CONCRETE PAVEMENT. THE GROOVES MAY BE CUT BY SAWING, GRINDING, OR OTHER METHOD AS APPROVED.
3. TEMPORARY RUMBLE STRIPS SHOULD NORMALLY BE THE RAISED DESIGN. THEY MAY BE GROOVES IF LOCATED IN A PAVEMENT THAT WILL BE REMOVED OR COVERED WITH A PAVEMENT COURSE BEFORE COMPLETION OF THE PROJECT. TYPICAL USES OF TEMPORARY RUMBLE STRIPS ARE FOR LANE CLOSURES OR ALIGNMENT CHANGES IN CONSTRUCTION ZONES.
4. THE HMA (RAISED RUMBLE STRIPS) SHALL BE PLACED ON A CLEAN, TACK COATED TREATED PAVEMENT IN  $\frac{3}{8}$ " IN. HIGH FORMS. THE FORMS SHALL BE REMOVED AND THE ASPHALT COMPACTED BY ROLLING ALONG THE STRIPS. EPOXY MORTAR SHALL BE FORMED, TROWELED, AND LEVELED WITH A ROLLER AND THE TOP EDGES ROUNDED, THERMOPLASTIC STRIPS SHALL BE APPLIED BY THE EXTRUSION PROCESS. PREFORMED PLASTIC SHALL BE INSTALLED IN CONFORMANCE WITH THE INSTRUCTIONS OF THE MANUFACTURER.

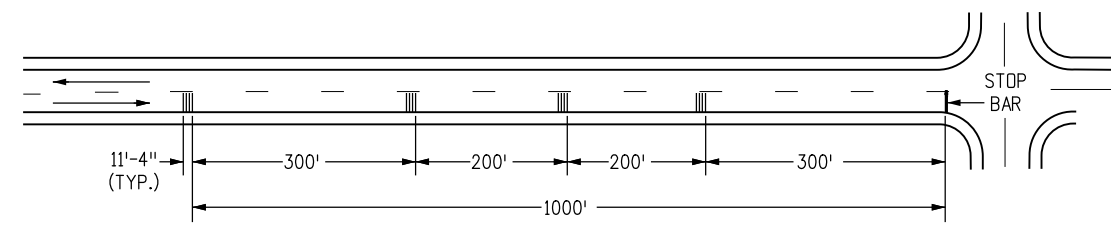

**STOP SIGN APPROACH**

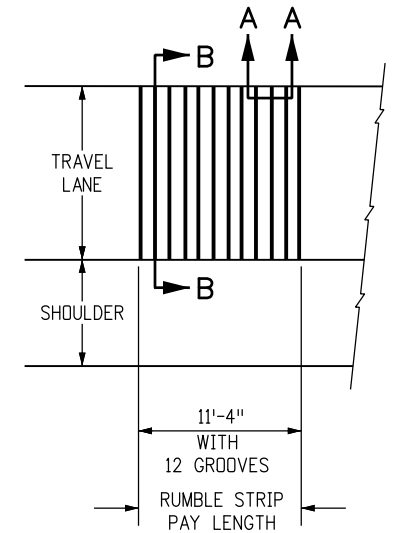

**TYPICAL RUMBLE STRIP CLUSTER**

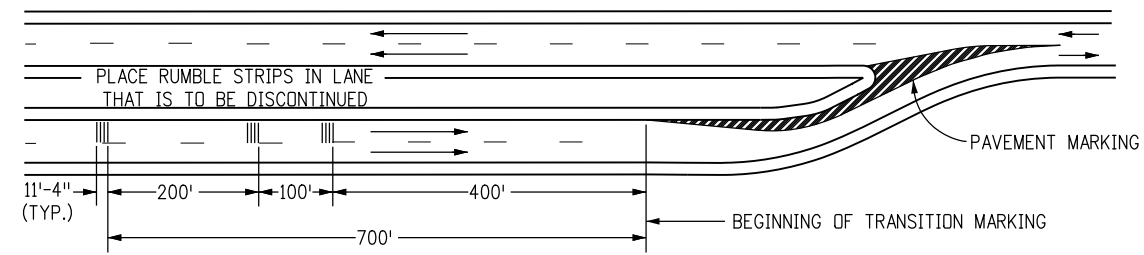

**LANE REDUCTION TRANSITION**

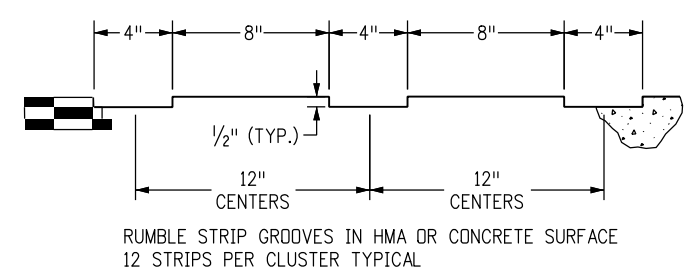

RUMBLE STRIP GROOVES IN HMA OR CONCRETE SURFACE  
12 STRIPS PER CLUSTER TYPICAL

**SECTION A-A (GROOVED)**

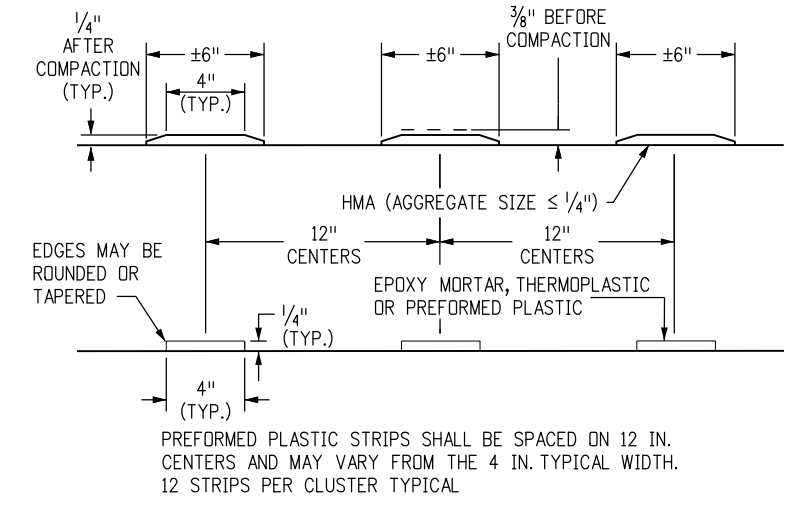

PREFORMED PLASTIC STRIPS SHALL BE SPACED ON 12 IN. CENTERS AND MAY VARY FROM THE 4 IN. TYPICAL WIDTH. 12 STRIPS PER CLUSTER TYPICAL

**SECTION A-A (RAISED)**

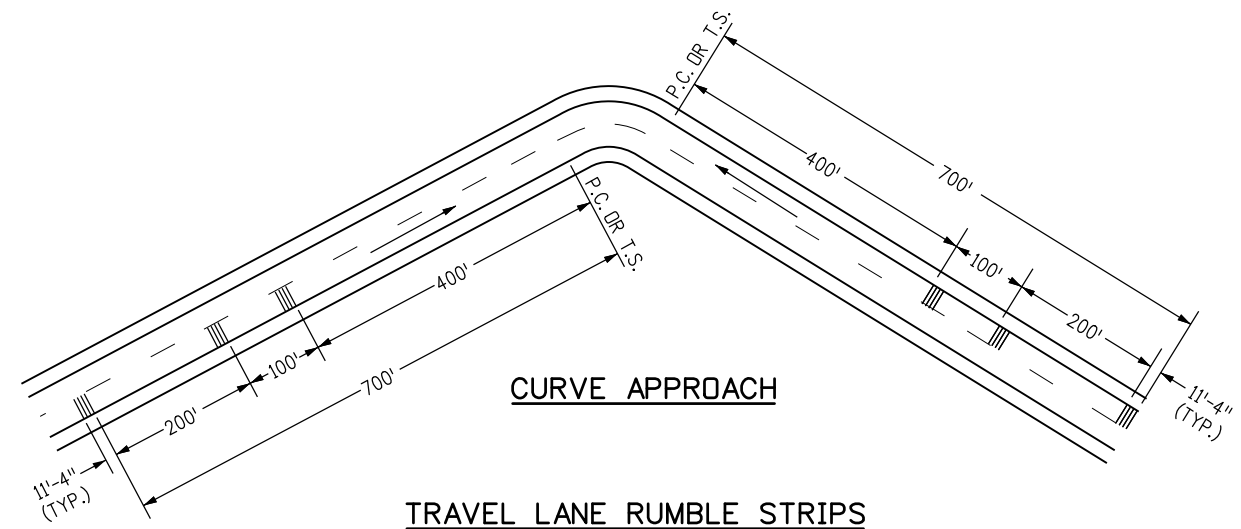

**TRAVEL LANE RUMBLE STRIPS**

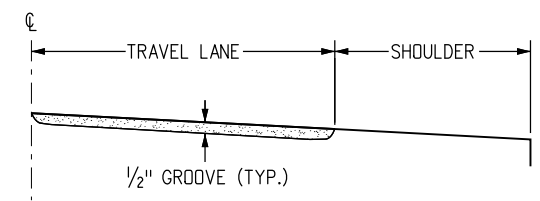

**SECTION B-B (GROOVED)**  
**PERMANENT GROOVED RUMBLE STRIPS**

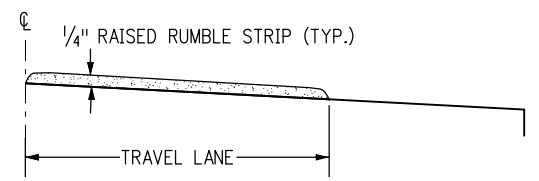

**SECTION B-B (RAISED)**  
**TEMPORARY RAISED RUMBLE STRIPS**

**Computer File Information**

Creation Date: 07/04/12	Initials: JBK
Last Modification Date: 07/04/12	Initials: LTA
Full Path: www.codot.gov/business/designsupport	(R-X)
Drawing File Name: 614010303.dgn	(R-X)
CAD Ver.: MicroStation V8	(R-X)
Scale: Not to Scale	Units: English

**Sheet Revisions**

Date:	Comments

Colorado Department of Transportation  
 2829 West Howard Place  
 CDDT HQ, 3rd Floor  
 Denver, CO 80204  
 Phone: 303-757-9021 FAX: 303-757-9868  
 Division of Project Support **JBK/LTA**

**RUMBLE STRIPS**

Issued By: Project Development Branch July 4, 2012

**STANDARD PLAN NO.**

M-614-1

Sheet No. 3 of 3