

Report No. CDOT-DTD-R-95-1

# **Demonstration of the Placement of Stone Matrix Asphalt in Colorado**

**Donna Harmelink, Research and Development**

**Tim Aschenbrener, Staff Materials**

**Ken Wood, Region 4 Materials**

**Colorado Department of Transportation**

**4201 East Arkansas Avenue**

**Denver, Colorado 80222**

**Interim Report**

**March, 1995**

**Prepared in cooperation with the  
U.S. Department of Transportation  
Federal Highway Administration**

The contents of this report reflect the views of the authors who are responsible for the facts and the accuracy of the data presented herein. The contents do not necessarily reflect the official views of the Colorado Transportation Institute, the Colorado Department of Transportation, or the Federal Highway Administration. This report does not constitute a standard, specification, or regulation.

## Acknowledgements

The project included a number of evaluation sections and a technical workshop including a field demonstration. The cooperation and efforts of Bituminous Roadways of Colorado (BROC) and Colorado Department of Transportation (CDOT) personnel made the success of this project possible. The authors would like to express appreciation to all the people involved in the design and construction of this project. It is impossible to include all of the people involved, but several are listed below.

Thanks to all of the members of the New Materials and Technology Oversight Group. They were instrumental in preparing the specification and finding a demonstration project.

Special thanks goes to Owen Leonard (CDOT Resident Engineer) and Doug Pearson (CDOT Project Engineer), his crew and Region 4 materials personnel for the added efforts they put forth to obtain and provide the required data for evaluation. Dave Casteel (Region 4 project tester) performed the testing and provided valuable information about the test results.

Bill Lauer, Bill Brown, Skip Bettis, Skip McRae, Roger Sterling, and John Cheever (BROC) assisted in gathering data used in this report and provided much support throughout the project. C.J. Stuka, Mike Farrar, and Robert Little (BROC) did the testing for the contractor. Jim Fife (Western Colorado Testing, Inc.) performed the mix designs shown in the report.

Nava Far and Benja Bemelen (CDOT Staff Materials) performed the mix testing with the European laboratory equipment and binder testing with the SHRP binder equipment.

The authors would also like to thank the workshop speakers: Doug Rames (Region 4), John Bukowski (FHWA), Jim Anagnos (Scanroad), Mickey Hines (Koch Materials, Inc.), Jim Scherocman (Consulting Engineer), and Scott Shuler (CAPA). Their presentations provided an excellent overview of the Stone Matrix Asphalt (SMA) process, and their assistance during the specification development and construction were invaluable.

The authors would also like to thank the research study panel: Bob LaForce and Steve Horton (CDOT Staff Materials), and Richard Zamora (FHWA, Colorado Division).

1. Report No. CDOT-DTD-R-95-1		2. Government Accession No.		3. Recipient's Catalog No.	
4. Title and Subtitle  Demonstration of the Placement of Stone Matrix Asphalt in Colorado				5. Report Date March 1995	
				6. Performing Organization Code File No. 16.04	
7. Author(s) Donna Harmelink, Tim Aschenbrener & Ken Wood				8. Performing Organization Rpt. No. CDOT-DTD-R-95-1	
9. Performing Organization Name and Address Colorado Department of Transportation 4201 East Arkansas Avenue Denver, Colorado 80222				10. Work Unit No. (TRAIS)	
				11. Contract or Grant No.	
12. Sponsoring Agency Name and Address Colorado Department of Transportation 4201 E. Arkansas Avenue Denver, Colorado 80222				13. Type of Rpt. and Period Covered Interim Report	
				14. Sponsoring Agency Code	
15. Supplementary Notes Prepared in Cooperation with the U.S. Department of Transportation Federal Highway Administration					
16. Abstract <p>The Stone Matrix Asphalt (SMA) experimental feature on SH-119, from SH-52 East to Longmont, is the Colorado Department of Transportation's (CDOT's) first attempt under contract to construct test sections for evaluation. The project successfully demonstrated the design, production, and placement of the European SMA.</p> <p>The research experiment on the project consisted of placing 11,000 tonnes of SMA using three different mix designs (two polymer stabilized mixtures and one fiber mixture). The two polymers were 1) Vestoplast S from Huls America and 2) PM-ID from Koch Materials Co. The fiber mixture used a cellulose fiber in pellet form from Arbocel.</p> <p>The material specifications used for the design of the SMA were adequate with a few exceptions. Several plant modifications were required to add the mineral filler and additives. Production through the plant was reduced significantly because of the addition of mineral filler. The rate of production was virtually cut in half from the normally expected 250 tonnes per hour to 150 tonnes per hour.</p> <p>Field performance data will be evaluated on an annual basis. Results will be available in approximately 3 years. Based on the European torture tests, it is expected that the SMAs will have very good field performance with respect to rutting and moisture damage.</p>					
17. Key Words Stone Matrix Asphalt, Stone Mastic Asphalt, polymers, fibers, SMA,			18. Distribution Statement No Restrictions: This report is available to the public through the National Information Service, Springfield, Virginia 22161		
19. Security Classif. (of this report) Unclassified		20. Security Classif. (of this page) Unclassified		21. No. of Pages 90	22. Price

## Table of Contents

1.0 Introduction .....	1
2.0 Project .....	3
2.1 Project Location .....	3
2.2 Test Sections .....	3
2.2.1 Types of Sections .....	3
2.2.2 Existing Distresses .....	4
2.3 Bids .....	8
2.4 Partnering .....	8
2.5 Texas Demonstration .....	9
2.6 Open House .....	9
3.0 SMA Mix Designs .....	11
3.1 Aggregate Tests .....	11
3.1.1 Gradation .....	11
3.1.2 Physical Properties .....	12
3.2 Additives .....	14
3.2.1 Fiber Pellets .....	14
3.2.2 Vestoplast S .....	14
3.2.3 Polymer Modified Asphalt Cement .....	14
3.3 Asphalt Cement Tests .....	14
3.4 Mixture Tests .....	16
3.4.1 Marshall Results .....	16
3.4.2 Specification Comments .....	16
3.4.3 AASHTO T 283 .....	17
3.4.4 Draindown Tests .....	17
3.5 Mineral Filler Tests .....	18
4.0 Construction .....	20
4.1 Plant Description .....	20
4.2 Plant Modifications for SMA .....	20
4.3 Haul Trucks .....	21
4.4 Laydown Operation .....	21
4.5 Trial Placement .....	26
4.6 Post-Construction Observations .....	26
4.6.1 Flushing .....	26
4.6.2 Smoothness .....	26
4.6.3 Skid Resistance .....	28
4.7 Future Post-Construction Evaluations .....	29
5.0 Field Verification Test Results .....	31
5.1 Asphalt Content, Field Compaction and Gradation .....	31
5.1.1 Test Results .....	31
5.1.2 Testing Problems .....	33
5.2 Volumetrics .....	34
5.3 Comparison of Texas Gyrotory and Marshall Compaction .....	36

6.0 European Torture Test Results . . . . .	38
6.1 Hamburg Wheel-Tracking Device . . . . .	38
6.1.1 Description of Test Equipment . . . . .	38
6.1.2 Test Results and Discussion . . . . .	41
6.2 French Rutting Tester . . . . .	42
6.2.1 Description of Test Equipment . . . . .	42
6.2.2 Test Results and Discussion . . . . .	44
6.3 Thermal-Stress, Restrained-Specimen Test . . . . .	44
6.3.1 Description of Test Equipment . . . . .	44
6.3.2 Test Results and Discussion . . . . .	48
6.4 Comparison of Mixtures . . . . .	48
7.0 Comparison of SMAs with Different Additives . . . . .	49
8.0 Summary and Recommendations . . . . .	51
8.1 Design . . . . .	51
8.2 Construction . . . . .	52
8.3 Performance . . . . .	53
9.0 Future Research . . . . .	54
10.0 References . . . . .	55

## Appendices

- Appendix A: SMA Specifications
- Appendix B: Locations of Various SMA Mixtures
- Appendix C: Hamburg Wheel-Tracking Device Test Results
- Appendix D: French Rutting Tester Results

## List of Tables

Table 1. Estimated and Bid Costs of the SMA and HMA. . . . .	8
Table 2. SMA Trial Blending Percentages. . . . .	11
Table 4. Aggregate Test Results. . . . .	12
Table 5. Asphalt Cement Test Results. . . . .	15
Table 6. Marshall Test Results. . . . .	16
Table 7. AASHTO T 283 Test Results. . . . .	17
Table 8. Draindown Test Results. . . . .	18
Table 9. Test Results on the Mineral Filler. . . . .	19
Table 10. Hydrometer Analysis (AASHTO T 88) Results on the Mineral Filler. . . . .	19
Table 11. Smoothness Results . . . . .	28
Table 12. Skid-Resistance Results . . . . .	30
Table 13. Asphalt Content and Field Compaction Test Results . . . . .	31
Table 14. Quality Level of Gradation Test Results . . . . .	32
Table 15. Gradation Test Results . . . . .	33
Table 16. Volumetric Test Results of Field Produced SMA. . . . .	35
Table 17. Test Results (mm of Deformation After 20,000 Passes) from the Hamburg Wheel-Tracking Device. . . . .	41
Table 18. Test Results (% Rut Depth After 30,000 Cycles) from the French Rutting Tester. . . . .	44
Table 19. TSRST Test Results. . . . .	48
Table 20. Comparison of the Different Additives Used in SMA. . . . .	50

## List of Figures

Figure 1. Location Map of Project No. NH 1191-005. . . . .	5
Figure 2. Location Map of the Evaluation Sections . . . . .	6
Figure 3. Overview of Existing Pavement Condition Prior to Construction. . . . .	7
Figure 4. Close-Up of Cracking Found on Project. . . . .	7
Figure 5. Plant Layout. . . . .	10
Figure 6. Field Inspection During Workshop. . . . .	10
Figure 7. Gradation of Trial Blend #2. . . . .	13
Figure 8. Auger System Initially Used for Vestoplast S. . . . .	22
Figure 9. Conveyor System Used to Add Vestoplast S and Fiber Pellets at the RAP Collar. . . . .	22
Figure 10. The Vestoplast S Was Supplied in 20 kg (45 lb) Bags. . . . .	23
Figure 11. The Fiber Pellets Were Supplied in 1000 kg (2200 lb) Bags. . . . .	23
Figure 12. Typical Laydown Operation. . . . .	24
Figure 13. The Breakdown Roller Was Kept Close to the Laydown Machine. . . . .	24
Figure 14. SMAs Allow for Neat Line Joints. . . . .	25
Figure 15. Surface Texture of the Finished Mat. . . . .	25
Figure 16. Limited Problems With Draindown Were Encountered. . . . .	27
Figure 17. Close-Up of Flushing Area. . . . .	27
Figure 18. Comparison of Air Voids from Texas Gyrotory and Marshall Compaction. . . . .	37
Figure 19. The Hamburg Wheel-Tracking Device. . . . .	39
Figure 20. Close-Up of the Hamburg Wheel-Tracking Device. . . . .	39
Figure 21. Typical Results from the Hamburg Wheel-Tracking Device. . . . .	40
Figure 22. French Rutting Tester. . . . .	43
Figure 23. Close-Up of the French Rutting Tester. . . . .	43
Figure 24. The TSRST Device. . . . .	46
Figure 25. Schematic of the TSRST Device. . . . .	46
Figure 26. Schematic of the Test Sample. . . . .	47
Figure 27. Typical TSRST Test Results. . . . .	47



# Demonstration of the Placement of Stone Matrix Asphalt In Colorado

Donna Harmelink, Tim Aschenbrener and Ken Wood

## **1.0 Introduction**

---

The European Asphalt Study Tour (1) which took place in the fall of 1990, found some technologies which had the potential to be transferred the United States. One of the more promising was a surface mix, Stone Matrix Asphalt (SMA). SMA is relatively new in the United States and shows promise as a tough, stable, rut-resistant surface mixture.

In 1992, the Colorado Department of Transportation (CDOT) and the asphalt contracting industry created oversight groups to study problems that faced the asphalt industry. The groups consisted of CDOT, FHWA, contractor and consulting firm personnel. One of the committees was the New Materials and Technology Oversight Group. This committee focused on SMA, wrote a specification, prepared a research proposal, and found a project to place the SMA.

The CDOT initially intended to construct a trial section of SMA on US-85 near Ault in 1992. Because of problems obtaining right-of-way, the project was delayed for one year. In 1993 the project was advertised, and the low bid exceeded the engineer's estimate by 28%. In order to start the already delayed project, the project was re-advertised and awarded without the SMA. In 1994, the SMA trial mixture was placed in the plans for a project on SH-119 near Niwot. Once again, the bids were significantly over the engineer's estimate. Adjustments were made to the plans and project budget, and the project was then re-advertised. In May of 1994, the \$2.45 million contract was awarded to Bituminous Roadways of Colorado.

There were only two bidders both times the project was advertised. During the past two construction seasons, there has been a significant increase in the amount of work advertised by the State. Not many contractors had the time to do the research required on the new and experimental SMA mixtures and keep up with the heavy volume of work being advertised.

The CDOT placed the SMA trial mixture in August and September of 1994. The purpose of this report is to document the process used to construct the trial mixture; including the mix designs, field construction, and field verification. At a later date, a follow-up study will be prepared to evaluate the long-term performance.

When SMA first came to the United States and Canada in 1991, Scherocman (2) documented the construction of the first five projects. More recently, Scherocman (3, 4) has documented some of the problems that have occurred on more than 50 additional SMA projects that have been constructed through 1994.

## 2.0 Project

---

### 2.1 Project Location

Project No. NH 1191-005 is located in Boulder County on State Highway 119 (Figure 1). The project extends approximately 5 miles between State Highway 52 on the southwest end to Hover Road in Longmont on the northeast end. The 1993 ADT was 23,500. The 10 year design ADT is 44,200 with 3% trucks. The designed traffic loading for 10 years was 807,000 18-kip ESALs.

### 2.2 Test Sections

#### 2.2.1 Types of Sections

The project contains five different mix designs:

- 1) standard dense graded HBP (Grading C),
- 2) Stone Matrix Asphalt (SMA) with Vestoplast S,
- 3) SMA with polymer modified asphalt, PM-ID, (AASHTO Task Force 31, Type I-D polymer, *Reference 5*),
- 4) SMA with cellulose fiber pellets, and
- 5) Grading C with AC-20R (AASHTO Task Force 31, Type II-B polymer).

The evaluation sections are located in both the north and southbound driving lanes on the north end of the project.

Nine evaluation sections were established on the project. The evaluation sections are as follows:

#### NORTHBOUND LANES

Grading C	one 2" (50 mm) lift
SMA with Vestoplast S	one 2" (50 mm) lift
SMA with PM-ID	one 2" (50 mm) lift
SMA with PM-ID	Bottom 2" (50 mm) lift (Grading C) Top 2" (50 mm) SMA with PM-ID
SMA with Fiber Pellets	Bottom 2" (50 mm) lift (Grading C) Top 2" (50 mm) SMA with Fiber Pellets
Grading C	Bottom 2" (50 mm) lift (Grading C) Top 2" (50 mm) Grading C with AC-20R

## SOUTHBOUND LANE

Grading C	Bottom 2-1/2" (64 mm) lift (Grading C) Top 2" (50 mm) lift Grading C with AC-20R
SMA with PM-ID	Bottom 2-1/2" (64 mm) lift (Grading C) Top 2" (50 mm) lift SMA with PM-ID
SMA with Vestoplast S	Bottom 2-1/2" (64 mm) lift (Grading C) Top 2" lift SMA with Vestoplast S

Each evaluation section is approximately 1000 feet long. A location map of the evaluation sections is shown in Figure 2.

### *2.2.2 Existing Distresses*

A preconstruction evaluation was performed on the project which consisted of measuring the ruts and cracks.

Rut depths were measured every 15 meters (50 feet) throughout the test sections in both the right and left wheel paths of the driving lane. The ruts were measured with a two-meter (six-foot) straight edge and were measured to the nearest 2 mm (0.1 in). Rutting in the evaluation sections was fairly low. The average of the sections ranged from 15 mm (0.6 in) in the northbound Grading C section to approximately 3 mm (0.1 in) in the southbound Vestoplast S section. The magnitude of the majority of the rut measured around 8 mm (0.3 in). According to CDOT's standard this measurement is considered low.

Crack maps were prepared for each of the evaluation sections. Cracking in the sections was fairly uniform. On the average, transverse cracks could be found every 5-m (15 ft) throughout the sections. Load associated longitudinal cracking was found in the wheel paths of the driving lane. In some areas the longitudinal cracking had deteriorated into block cracking and in other areas alligator cracking. The cracks were wide (up to 25 mm) and many had begun to deteriorate on the edges. Although the pavement in the southbound lanes on the north end of the project had been covered by a thin maintenance blade patch the severity and amount of distress in all the evaluation sections prior to construction were considered to be equal for evaluation purposes. Typical distress found in the existing pavement is shown in Figures 3 and 4.

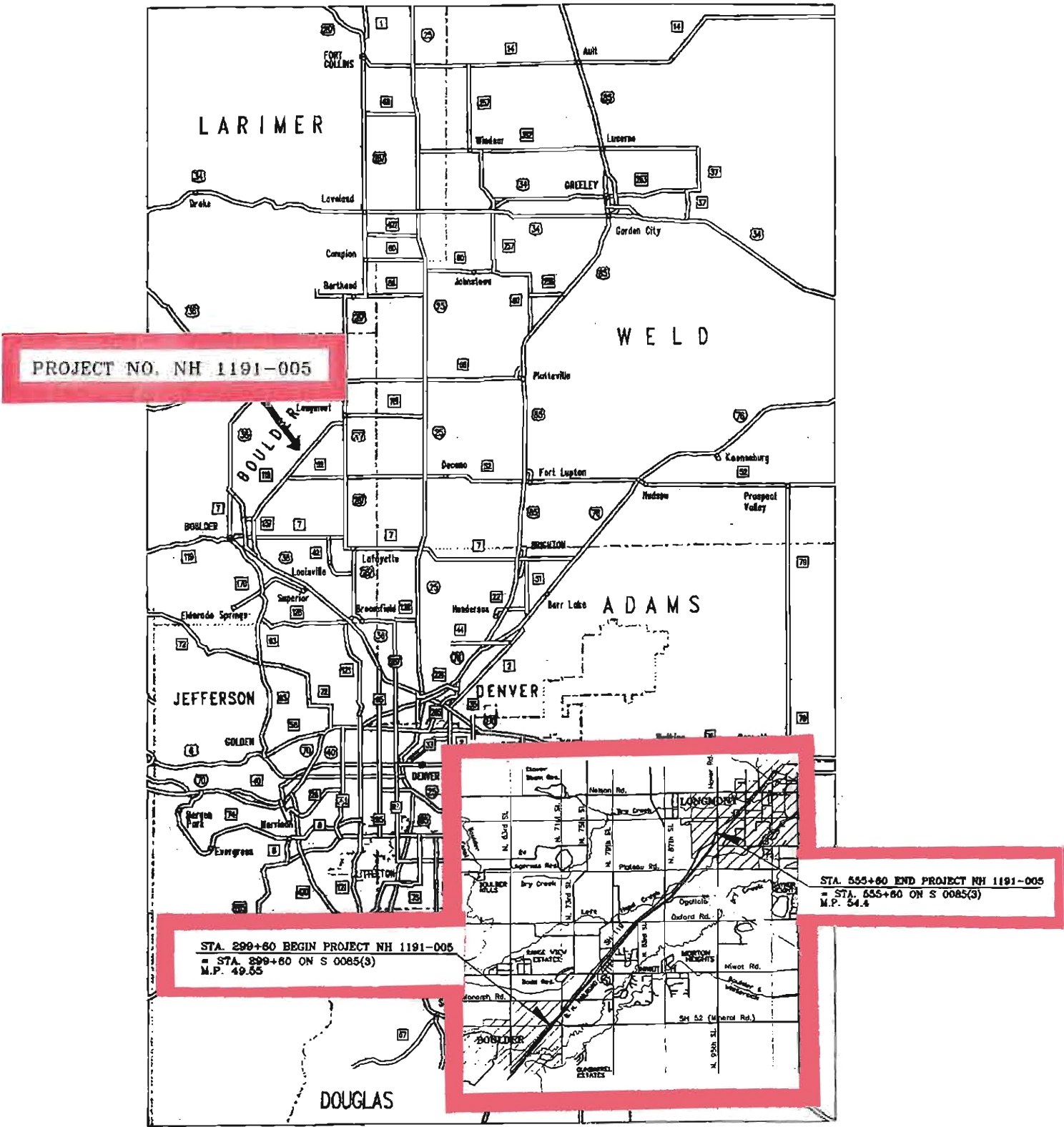
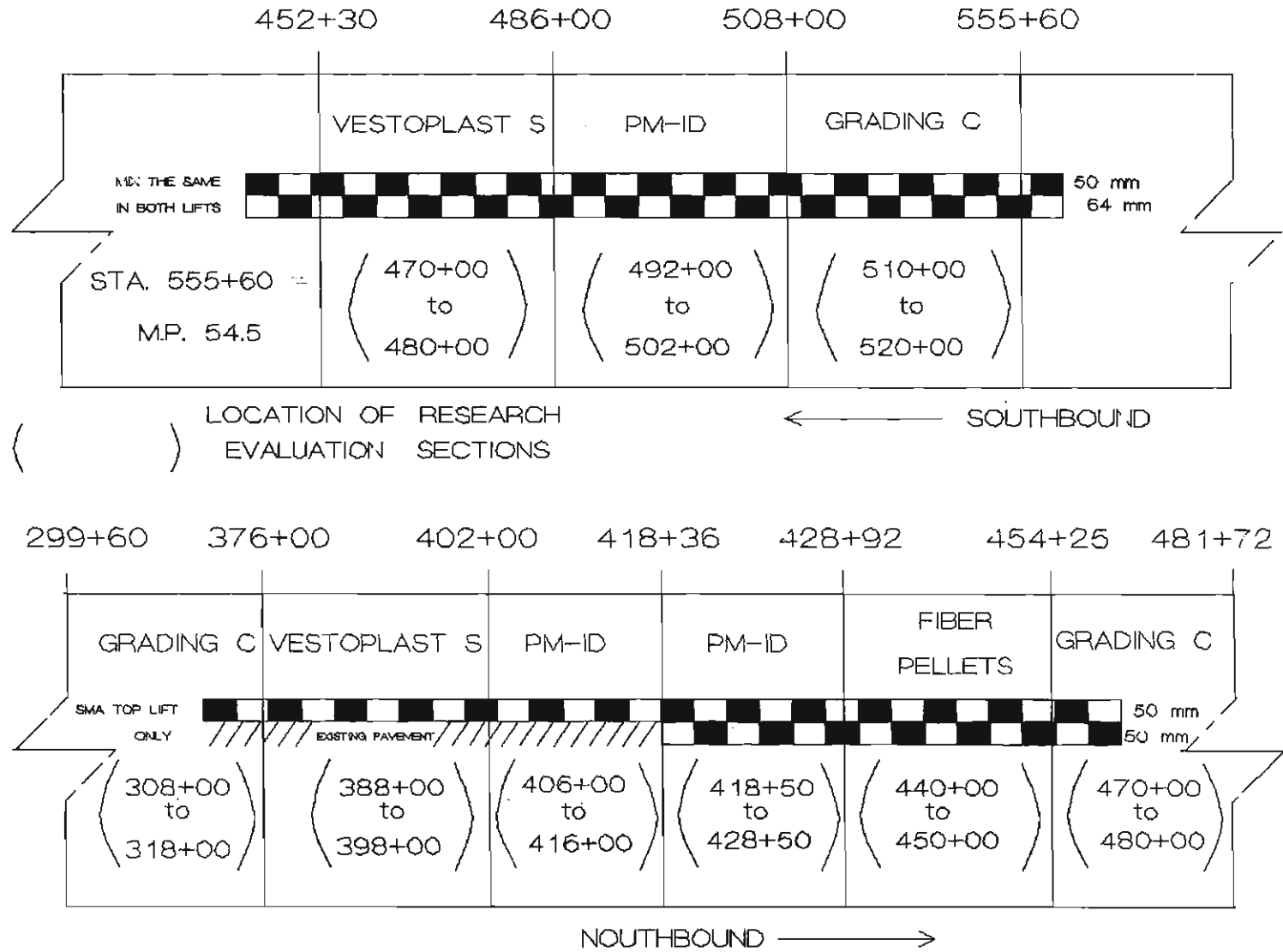

Figure 1. Location Map of Project No. NH 1191-005.

Figure 2. Location Map of the Evaluation Sections.





**Figure 3. Overview of Existing Pavement Condition Prior to Construction.**

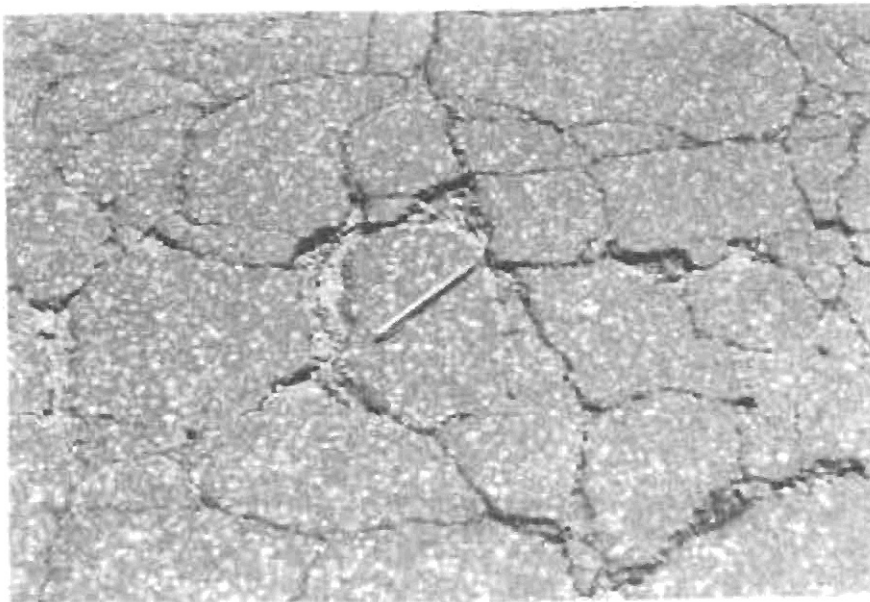

**Figure 4. Close-Up of Cracking Found on Project.**

## 2.3 Bids

A pre-bid conference was held prior to the advertisement of this project. All contractors bidding on this project were required to attend the pre-bid conference to review requirements for the various test sections including the SMA requirements. The break down of the final bids for each of the different designs is shown in Table 1. The contractor's bid exceeded the engineer's estimate for the SMAs.

Table 1. Estimated and Bid Costs of the SMA and HMA.

	Engineer's Estimate (cost/ton)	Contractor's Bid (cost/ton)	Difference (%)
SMA Vestoplast S	\$47.00	\$54.00	+ 15
SMA Fiber Pellets	\$43.00	\$59.00	+ 37
SMA PM-ID	\$47.00	\$63.00	+ 34
Grading C	\$28.00	\$24.50	- 13
Grading C (AC-20R)	\$33.00	\$30.00	- 9

The costs for each ton of HMA includes the asphalt cement, the modifier, haul and placement.

## 2.4 Partnering

A partnering workshop was held on June 28, 1994. In attendance were Colorado project personnel which included the project engineer, the resident engineer, the materials engineer, the construction engineer, and the asphalt research engineer. Personnel from the contractor included the project superintendent, the project estimator and the quality control engineer. Since SMA was new to both the CDOT and the contractor, it was very critical that this partnering workshop was productive. This workshop helped to point out the conflicts which could arise during construction and offered methods to resolve them. With the complexity of this project, both the contractor and CDOT personnel considered this partnering session was very beneficial.

Project requirements also included hosting a technical workshop and on-site demonstration which required cooperation and coordination of both the CDOT and contractor.



## **2.5 Texas Demonstration**

Prior to construction, CDOT and contractor personnel had the opportunity to attend a one day technical session and demonstration of a SMA project in Amarillo, Texas. This demonstration provided CDOT and the contractor an insight into what to expect during the construction of Colorado's project: for example, plant operations, plant modifications, final appearance of the mat, and others.

## **2.6 Open House**

During construction of the Colorado project a demonstration workshop to view the production and placement of the SMA pavement located on SH 119, from SH 52 to Hover Road was held. Included in the demonstration was a four-hour seminar. The seminar covered the FHWA, state and contractor/industry perspective. In addition the perspective of suppliers of the specialty items were addressed. The variety of presentations provided a wide range of perspectives.

The technical seminar was held on August 29, 1994. On August 30, 1994, participants were transported to the plant and construction sites. Project and construction personnel were on hand to answer questions during the tours. Approximately 50 people attended the workshop and on-site demonstration. The workshop participants represented FHWA, state, city, county, and industry personnel.

Because of complications with plant set-up and problems associated with the aggregate supply for the SMA, the contractor did not have the opportunity to place a large quantity of the SMA mix prior to the demonstration. However, approximately 500 tonnes were placed on a section of the shoulder prior to the demonstration. This small section provided the contractor with enough information that the demonstration went very smoothly.

Photographs from plant and laydown operation taken during the open house are shown in Figures 5 and 6.



**Figure 5. Plant Layout.**



**Figure 6. Field Inspection During Workshop.**

### 3.0 SMA Mix Designs

---

The specifications used for the project are shown in Appendix A.

#### 3.1 Aggregate Tests

All of the aggregates were granite and came from the Cooley Morrison Quarry. The stockpiles used for the SMA included a 19-mm (3/4-in) rock, a 12.5-mm (1/2-in) rock, a granite sand, and a washed granite sand.

##### 3.1.1 Gradation

For the mix design, there were two trial blends that were investigated. Trial Blend #2 was used for most of the project. The percentage of each stockpile and the composite gradations are shown in Tables 2 and 3.

Table 2. SMA Trial Blending Percentages.

Stockpile	Trial Blend #1	Trial Blend #2
19.0-mm Rock	37%	37%
12.5-mm Rock	30%	34%
Granite Sand	13%	13%
Washed Granite Sand	12%	10%
Limestone Dust	7%	5%
Hydrated Lime	1%	1%

The gradation for Trial Blend #2 was slightly out of the Master Range on the 4.75 mm, 2.36 mm, and 75  $\mu$ m sieve sizes. This was considered acceptable for two reasons. First, the Master Range specification for this project was developed based upon recommendations by the FHWA in 1992. Since that time, the FHWA recommendations have been modified with the experience of many projects throughout the country. The gradation of Trial Blend #2 is within the Master Range currently recommended by the FHWA (6). Second, the VMA of Trial Blend #2 was higher than Trial Blend #1. The project specifications were modified on the job. The gradation of Trial Blend #2 is shown in Figure 7.

**Table 3. SMA Composite Gradations.**

Sieve Size	Trial Blend #1	Trial Blend #2	CDOT Specification	FHWA Rec.(6)
19.0 mm (3/4")	100	100	100	100
12.5 mm (1/2")	84	84	82 - 88	85 - 95
9.5 mm (3/8")	62	61		75 max
4.75 mm (No. 4)	30	27	28 - 32	20 - 28
2.36 mm (No. 8)	19	17	18 - 22	16 - 24
600 µm (No. 30)	14	12		
300 µm (No. 50)	13	11		
75 µm (No. 200)	9.1	7.4	9 - 11	8 - 10

**3.1.2 Physical Properties**

The tests results on the fine and coarse aggregates are shown in Table 4.

**Table 4. Aggregate Test Results.**

Test	Procedure	Result	Specification
AASHTO T 96	LA Abrasion	24	30% max
ASTM D 4791*	Flat and Elongated 3 to 1 5 to 1	6% 1%	20% max 5% max
AASHTO T 104	Sodium Sulfate Soundness	1.2%	15% max
CP-45	Fractured Faces, One or more Two or more	100% 100%	100% min 90 % min
AASHTO T 89	Liquid Limit	No value	25 max
AASHTO TP 33*	Fine aggregate angularity	48.9	45 min

\* - Tests in addition to the CDOT specification (SHRP Recommendation).

**COLORADO DEPARTMENT OF HIGHWAYS  
GRADATION CHART**

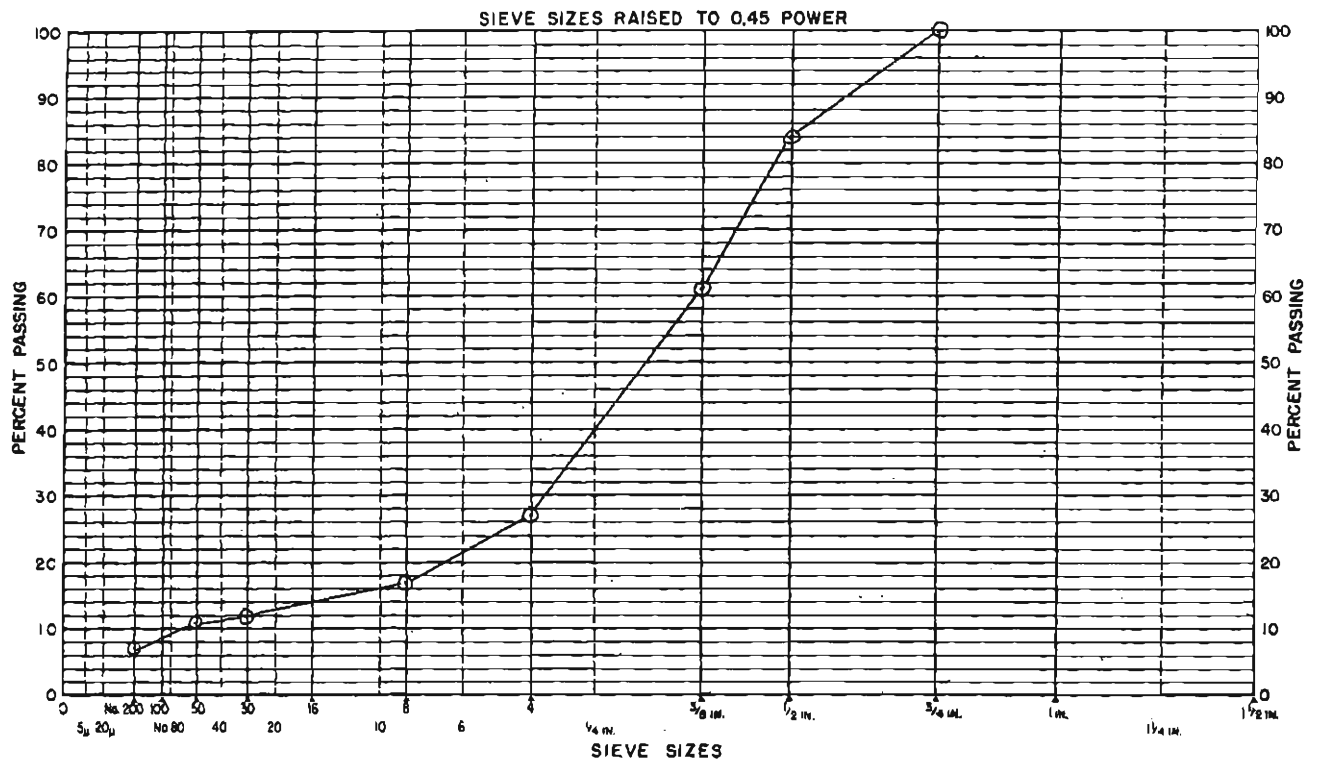

Figure 7. Gradation of Trial Blend #2.

All of the tests were acceptable. Some of the tests were not specified on the project; however, all of the tests in Table 4 are recommended by the FHWA (6).

## **3.2 Additives**

Additives were used in order to prevent the asphalt cement from draining out of the SMA during hauling and placement. Three different additives were used on the project.

### *3.2.1 Fiber Pellets*

Fiber pellets consisting of 66% fibers and 34% asphalt cement were used in one of the SMA mixtures. They were added through the RAP collar in order to stiffen the asphalt cement to prevent draindown. The pellets were manufactured by Arbocel using cellulose fibers. The fibers were added at a rate of 0.3% by weight of the mixture; so the fiber pellets were added at a rate of approximately 0.5%.

### *3.2.2 Vestoplast S*

Vestoplast S is a polyolefin manufactured by Huls of America. Vestoplast S is added through the RAP collar of the mixing plant. It coats the aggregate before the asphalt cement is added. The Vestoplast S stiffens the asphalt cement to prevent draindown. The Vestoplast S was added at a rate of 7% by weight of asphalt cement.

### *3.2.3 Polymer Modified Asphalt Cement*

The polymer modified asphalt cement was supplied directly to the project site from an independent polymer modifying company (Koch Materials Co.). The polymerized asphalt cement was delivered to the mixing plant and placed directly in the asphalt storage tanks used at the plant. The polymer was an SB block copolymer and was added at a rate of 4.5% by weight of asphalt cement. The polymer met the AASHTO Task Force 31, Type I-D specifications (5). It will be referred to as PM-ID. The polymer is supposed to stiffen the asphalt cement and prevent draindown.

## **3.3 Asphalt Cement Tests**

The asphalt cement conformed to AASHTO M 226, Table 2. The base asphalt cement and the

asphalt cement and additive blends were tested with the standard and SHRP binder equipment. Only the dynamic shear rheometer (DSR) was used for the SHRP binder equipment. The DSR is used to characterize the high temperature performance of the asphalt cement. Test results are summarized in Table 5. The Sinclair AC-20 was blended with the Vestoplast S and fiber pellets in the laboratory. It is not clear if the test results on the DSR with the fibers are a true representation of the Performance Grade. The fibers are probably not chemically bonded with the asphalt cement.

**Table 5. Asphalt Cement Test Results.**

Refinery	Grade	Viscosity poise @ 60°C	Penetration dmm @ 25°C	DSR Temp. (°C) @ 2.2 kPa	SHRP PG (High Temp.)
Sinclair	AC-20	1800	67	66	64
Sinclair	AC-20 (fibers)	NT	NT	>82	76
Sinclair	AC-20 (VS)	NT	NT	71	70
Conoco	PM-ID	NT	72	73	70
Conoco	AC-20R	2050	108	65	64

NT - Not Tested  
 VS - Vestoplast S  
 PM-ID - Polymer modified, Type I-D

The PM-ID was manufactured by Koch Materials Co. using Conoco asphalt and SB copolymers. The Grading C test section was constructed with AC-20R asphalt supplied by Conoco.

As shown in Table 5, the Vestoplast S and PM-ID increased the high temperature stiffness by one grade. Although the fibers increased the asphalt cement two grades, it is not certain the fibers and asphalt cement are chemically bonded. The AC-20R had the same high temperature grade as the AC-20.

### 3.4 Mixture Tests

#### 3.4.1 Marshall Results

The tests for the mix design were performed by the contractor. The test results for the two trial blends with each of the additives are shown in Table 6. Trial Blend #2 was chosen for use on the project. The Marshall mix design used 50 compaction blows on each side of the specimen.

**Table 6. Marshall Test Results.**

Property	Specification	Trial Blend #1			Trall Blend #2		
		Fiber	VS	PM-ID	Fiber	VS	PM-ID
VTM (%)	3-4	3.9	3.5	3.5	3.4	3.2	3.4
Asphalt Content (%)		5.4	5.5	5.3	6.2	6.0	6.0
VMA (%)	15.0 min	15.0	15.5	15.0	16.7	16.4	16.6
Stability, N (lb)	5300 min (1200)	11020 (2480)	10040 (2260)	12530 (2820)	8220 (1850)	9910 (2230)	11420 (2570)
Flow, 0.25 mm (0.01 in)	10-18	15	17	16	18	16	18

VTM - Voids In the Total Mix (Air Voids)

VMA - Voids in the Mineral Aggregate

VS - Vestoplast S

PM-ID - Polymer Modified, Type I-D

#### 3.4.2 Specification Comments

The specifications for this project were developed in 1992 and were adequate with a few exceptions. Since that time, the FHWA has recommended new specifications (6). There have been some significant specification changes. The FHWA recommends the VMA be a minimum of 17.0% instead of the previously recommended 15.0%. Based on the results from this project, the use of the higher VMA should be used on future CDOT projects.

Additionally, there is a minimum asphalt content requirement of 6.0%; previously there was no



minimum recommendation. There is no need for both a VMA and minimum asphalt content requirement. Only the VMA requirement should be used.

### 3.4.3 AASHTO T 283

Moisture resistance testing was performed using AASHTO T 283. The freeze cycle was used. The test results are shown in Table 7. The PM-ID had the best results and passed the minimum tensile strength ratio (TSR) specification of 0.80. The Vestoplast S did not pass, but was marginally unacceptable. The SMA with fiber pellets did very poorly.

Table 7. AASHTO T 283 Test Results.

Additive	TSR	Air Voids (%)	Saturation (%)
Fiber	0.59	6.3	59
Vestoplast S	0.70	6.3	68
PM-ID	0.81	6.8	59

Because the test results were marginally passing at best, concerns developed. The SMA should be moisture resistant because it has a very high asphalt content and thick coatings of asphalt on the aggregates. Therefore, the Hamburg wheel-tracking device was used to test the SMA for moisture resistance, and results (shown in Chapter 6) were much more favorable. It is possible that AASHTO T 283 tests may not accurately represent the moisture susceptibility of the SMA. The future field performance will be the ultimate test.

### 3.4.4 Draindown Tests

Two different draindown tests were performed for this study. The National Center for Asphalt Technology (NCAT) developed a procedure (6) that uses a wire basket. Approximately 1200 grams of SMA are held at 153°C (307°F) for 1 hour. During this time, asphalt cement may drain off the SMA, through the wire basket, and onto a paper plate. The weight of a plate that supports the wire basket is measured before the test starts and after the 1 hour; and the difference is the asphalt draindown. The result is the draindown calculated as a percent of the total weight of the mix.

The Schellenberg procedure is virtually identical to the NCAT method with two exceptions; 1) glass beakers are used instead of the wire basket, and 2) the temperature is 170°C (338°F). The draindown is measured as the amount of asphalt that stays coated onto the glass beaker.

All of the tests were performed at the optimum asphalt content (see Table 6) of Trial Blend #2. The test results are shown in Table 8. The ranking of the different materials to stop draindown was the same for both tests. The fiber pellets did the best and the polymer (PM-ID) did the worst. It should be noted that no problems with draindown were observed with any of the additive stabilizers on the project.

**Table 8. Draindown Test Results.**

Additive	NCAT	Schellenberg	Specification
Fiber	0.0%	0.0%	< 0.3%
Vestoplast S	0.7%	0.2%	
PM-ID	2.8%	0.7%	

**3.5 Mineral Filler Tests**

The mineral filler used for this project was a crushed grey limestone (CAL 200) dust that was purchased from Pete Lien Lime and shipped to the project from north of Ft. Collins. The limestone dust was tested for the properties recommended by the FHWA (6): particle size (AASHTO T 88) and plasticity index (AASHTO T 90); and for the properties used in Europe: Rigden voids index (7) and methylene blue (ISSA Technical Bulletin No. 145). The test results are shown in Table 9.

The particle size was measured from the hydrometer analysis (AASHTO T 88) and the results are shown in Table 10. The filler was finer than recommended, but since it was not specified, the results are presented for research purposes. Additionally, the Rigden voids did not meet the minimum specification. It should be mentioned that these tests were on the mineral filler only, and the recommendation likely applies to the entire material passing the 75 µm (No. 200) sieve size.

**Table 9. Test Results on the Mineral Filler.**

Test	Result	Recommendation
Particle size smaller than 20 $\mu$ m	42%	< 20%
PI	Non-plastic	< 4%
Methylene blue	4.5 mg/g	< 10 mg/g
Rigden voids index	44.1%	< 40%

**Table 10. Hydrometer Analysis (AASHTO T 88) Results on the Mineral Filler.**

Size ( $\mu$ m)	Percent Passing
75	83
20	42
2	2

## **4.0 Construction**

---

### **4.1 Plant Description**

A CMI 1700 parallel-flow, drum mixer with a production capacity of 250 tonnes per hour was used on this project. The fuel source was No. 2 Diesel. The SMA mixes required four cold feed bins with a retrofit for the addition of mineral filler (limestone). A silo to store the mineral filler was required. The silo used for the mineral filler had a 45 tonne capacity. Lime was added with a weigh pod and vane feeder and mixed with damp aggregate in an approved pugmill. A baghouse was used for emission control. The storage silo for the HMA had a 100 tonne capacity.

### **4.2 Plant Modifications for SMA**

The production of the SMA required several modifications to the plant to properly add the different additives. It should be noted that no modifications to the plant were necessary to add the PM-ID.

A cement silo was set up with a metering device to add the mineral filler. The specifications required the mineral filler be added at the same point as the asphalt cement. Both the mineral filler line and the asphalt cement line entered the rear of the mixing drum and were discharged into a mixing head. This allowed the asphalt cement to coat and capture the mineral filler, which helped to prevent blowing the mineral filler out of the drum and into the baghouse. Although mineral filler was found in the baghouse, extraction tests run on the produced mixes indicate the minus 75  $\mu\text{m}$  (No. 200) sieve size material was reasonably close to the job mix proportions specified.

The rate of production was virtually cut in half from the normally expected 250 tonnes per hour to 150 tonnes per hour. This does not always occur depending on how the plant is modified to add the mineral filler. The rate was cut in half for this project because the mineral filler feed-line was not large enough.

The fiber pellets and Vestoplast S were each added at the RAP collar. The Vestoplast S was conveyed up through a 125 mm (5 in) fixed-diameter auger. Due to the gummy consistency and

caking of the Vestoplast S, the blades of the auger were sheared from the shaft. The auger that fed the Vestoplast S was then modified to be an open-troughed auger with a plate on top. This auger was also unsuccessful. Finally, a shingle conveyor was used to transport the Vestoplast S to the RAP collar. The shingle conveyor had slats on the belt to prevent the Vestoplast S from sliding down the conveyor. This method worked well (except in high wind conditions) and was used for the remainder of the project. The fiber pellets were added only with the shingle conveyor.

The quantity of SMA produced on this project was small; however, if a larger quantity was produced the contractor indicated a more sophisticated operation for incorporating the additives would be utilized. The plant operation is shown in Figures 8 through 11.

### **4.3 Haul Trucks**

The HMA was delivered to the project with end-dumps and live-bottom trucks. The round-trip haul time was approximately 60 minutes. The haul trucks were required to be covered with a full tarp. The PM-ID mixture was delivered to the project at 143°C to 154°C (290°F to 310°F); the Vestoplast S and fiber mixtures were delivered at 138°C to 143°C (280°F to 290°F).

### **4.4 Laydown Operation**

One Blaw-Knox 510 paver with a variable width screed and extended augers was used. Paving widths ranged from 3 to 5 m (10 to 16 ft). Three rollers were used to compact the SMA. Because SMAs perform differently during the compaction process, a roller pattern were difficult to establish. The final roller pattern that was established used two steel-wheeled rollers for breakdown (Caterpillar 534B) and one steel-wheeled roller for finishing (Hyster 766). The first roller used for breakdown was a 10 tonne roller which made one pass in the vibratory mode and one in the static mode. The next roller (10 tonne) made two passes in the vibratory mode and two passes in the static mode. A 7 tonne steel-wheeled roller operated in the static mode as the finish roller. A pneumatic roller was not used on the SMA pavement. It is very critical that rollers are kept close to the laydown operation. Photographs of construction are shown in Figures 12 through 15.



**Figure 8. Auger System Initially Used for Vestoplast S.**



**Figure 9. Conveyor System Used to Add Vestoplast S and Fiber Pellets at the RAP Collar.**



**Figure 10. The Vestoplast S Was Supplied in 20 kg (45 lb) Bags.**



**Figure 11. The Fiber Pellets Were Supplied In 1000 kg (2200 lb) Bags.**



**Figure 12. Typical Laydown Operation.**



**Figure 13. The Breakdown Roller Was Kept Close to the Laydown Machine.**





**Figure 14. SMAs Allow for Neat Line Joints.**



**Figure 15. Surface Texture of the Finished Mat.**

## **4.5 Trial Placement**

The project plans required the contractor to place a test section prior to construction to evaluate the contractor's ability to both produce and place the SMA. To satisfy this requirement the contractor placed 500 tonnes of the polymer modified SMA (PM-ID) on the shoulder. During this placement, no problems were encountered.

## **4.6 Post-Construction Observations**

### *4.6.1 Flushing*

In the entire project there was only one small area that flushed. This was not a concern and could possibly be traced back to an isolated problem at the plant during production. The plant had an emergency shut-down at the same time the area that flushed was paved. There may be a correlation between the flushing and the emergency shut-down, but it is not certain. The flushing occurred in the PM-ID.

Photographs of this isolated area are shown in Figures 16 and 17.

### *4.6.2 Smoothness*

Smoothness measurements were required for standard HBP on this project. Although smoothness was not a specification for the SMA construction areas, the contractor elected to run the profilograph on the nine evaluation sections for information.

Smoothness testing was done by the contractor using a computerized profilograph (CS 8200) manufactured by James Cox and Sons.

Smoothness was measured in the right and left wheel path of both the driving and passing lanes. The right and left wheel path measurements were averaged for each lane and converted into a profile index value of mm/km (inches per mile). Smoothness was recorded for each of the nine evaluation sections and the profile index values are shown in Table 11.

The 1994 CDOT specification uses a 2.5 mm (0.1 inch) blanking band. Any profile index over 110 mm/km (7 inches/mile) falls into the disincentive section of the specification, and any profile



**Figure 16. Limited Problems With Dralndown Were Encountered.**

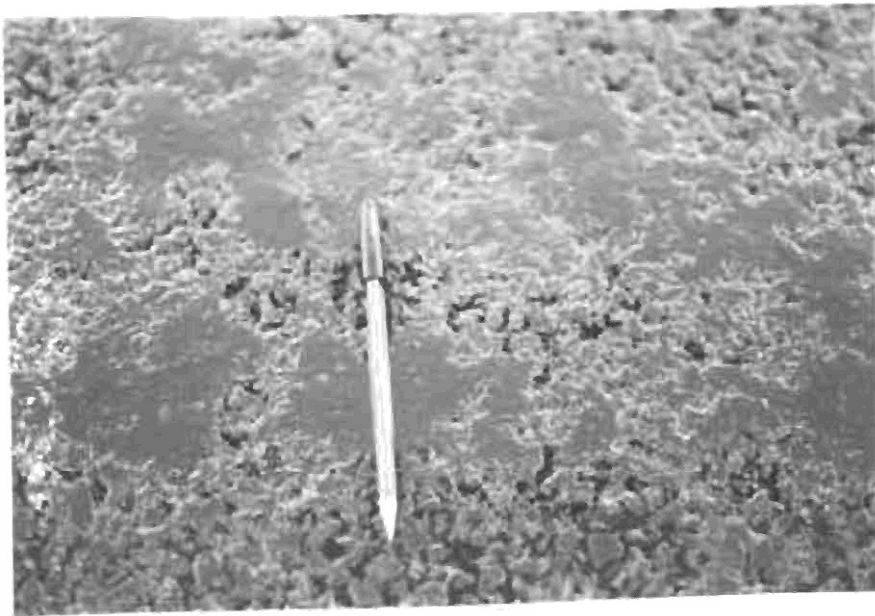

**Figure 17. Close-Up of Flushing Area.**

index over 189 mm/km (12 inches/mile) requires corrective work. In 1995 the CDOT will have a new smoothness specification.

Under the 1994 CDOT smoothness specification, all but two of the evaluation sections measured required corrective work. (Since smoothness of the SMA sections was not in the specification, the contractor was not required to correct these sections.) Based on the smoothness index values of the standard HBP on this project, it does not appear that SMA in itself is the cause of the high roughness values.

Smoothness values will be taken during each yearly evaluation to determine any changes in ride quality of the SMA pavements.

**Table 11. Smoothness Results**

	PROFILE INDEX INCHES/MILE	
	Passing Lane	Driving Lane
Grading "C" (Southbound)	29.41	19.69
PM-ID (Southbound)	23.66	19.97
Vestoplast S (Southbound)	25.24	23.24
Grading "C" (Northbound)	21.10	9.17
Vestoplast S (Northbound)	21.32	17.26
PM-ID (Northbound) *	21.60	9.61
Fibers (Northbound)	18.64	19.27
Grading "C" (Southbound)	26.48	16.87

\* The smoothness index value for both PM-ID sections in the northbound direction was reported as one section.

#### **4.6.3 Skid Resistance**

Skid testing was performed on the entire project in November following construction. Minimum skid-resistant guidelines reported by other states range from 30 to 40 for interstate highways and all highways with legal speeds in excess of 65 km/h (40 mph) (8). Although CDOT does not

have a defined policy for skid resistance, skid resistance values of less than 35 should be addressed.

Skid resistance on this project was measured using the equipment and procedure described in ASTM E 274. The measuring was done with a rib tire (ASTM E 501) at 65 km/h (40 mph) in the left wheel path of the outside driving lane.

The values recorded on all the sections were similar. The values are shown in Table 12. The average values ranged between 52 and 55.9. There was no distinct difference in the values between the SMA pavement and the standard Grading C pavement. However, because of the smoothness specification on the Grading C portion of the project, there were a few areas which required grinding. Skid numbers measured on the ground areas measured about 10 points lower than the unground areas (41.6 - 44.5).

Skid numbers will be taken in the fall of each year over the three year evaluation period of this study. It is anticipated that the skid-resistance values on the SMA portion of this project will increase. This is based on the evaluation of the SMA Technical Working Group (TWG) (9).

#### **4.7 Future Post-Construction Evaluations**

The evaluation sections will be evaluated each year for three years. The evaluation will include measuring ruts, crack mapping, skid testing, and an overall visual inspection. Cores will be taken to monitor air voids.

Upon completion of each yearly evaluation, notes will be prepared documenting the performance to date of each evaluation section.

At the conclusion of the study a final report will be prepared documenting, evaluating and making recommendations as to the future of SMA mixes in Colorado.

**Table 12. Skid-Resistance Results**

Evaluation Sections **	Skid-Resistance		
	Avg	S.D.	n
Grading "C" (Northbound)	54.6	2.57	10
Vestoplast S (Northbound)	55.9	1.96	10
PM-ID (Northbound)	53.5	1.18	9
PM-ID (Northbound)	55.0	1.25	6
Fiber Pellets (Northbound)	52.0	1.49	8
Grading "C" Ground (Northbound)	44.5	3.25	7
Grading "C" (Northbound)	53.3	1.46	8
Grading "C" Ground (Southbound)	41.6	2.08	6
Grading "C" (Southbound)	53.7	1.85	4
PM-ID (Southbound)	55.2	1.75	10
Vestoplast S (Southbound)	55.5	2.32	12

\*\* Location of evaluation section numbers can be found in Figure 2.

Avg - Average

S.D. - Standard Deviation

n - number of readings

## 5.0 Field Verification Test Results

### 5.1 Asphalt Content, Field Compaction and Gradation

#### 5.1.1 Test Results

The SMA sections were placed with varying asphalt content (AC) percentages. The AC percentages for the Vestoplast S sections ranged from 5.4 to 5.8%, the AC percentages in PM-ID sections ranged from 5.8 to 6.0%, and the fiber section was placed with 6.0% AC. A summary of the percent AC and the location for all the SMA sections can be found in Appendix B. The Quality Level for the AC percentage of all the SMA mixes were all accepted based on the limited data available. The results for the various SMA mixes at the designated AC percentage are summarized in Table 13.

**Table 13. Asphalt Content and Field Compaction Test Results**

Additive	Asphalt Content (%)				% of Maximum Density			
	Avg	S.D.	n	Q.L.	Avg	S.D.	n	Q.L.
Vestoplast S (5.5% AC)	5.4	.11	6	100	92.2	1.58	4	12
Vestoplast S (5.6% AC)	5.7	.08	6	100	92.9	1.14	5	18
Fibers (6.0% AC)	5.8	.22	3	66	94.0	2.26	3	28
PM-ID (6.0% AC)	6.0	.11	9	100	93.0	1.58	9	25

Avg - Average

S.D. - Standard Deviation

n - number

Q.L. - Quality Level (percent within specification)

During construction the nuclear gauge was used to determine densities. It was soon concluded that there did not appear to be any correlation between the densities obtained with the nuclear gauge and the cores. The densities obtained using the nuclear gauge were always lower than the densities for the cores, but the correlation was very inconsistent. Therefore, densities of the SMA were controlled using cores.

The minimum compaction specification for this project was set at 94% of the Rice (AASHTO T 209) value. The average compactions obtained for the SMA mixes, as shown in Table 13, ranged from 92% (Vestoplast S section) to 94% (fiber section). Despite a joint effort between the contractor and CDOT to optimize various compaction techniques, obtaining the minimum compaction of 94% was difficult. It is believed that 94% is required, but it could not be obtained on this project. Therefore, rollers should have been used more effectively, or better SMA mixture specifications could have resulted in a more compactable mix.

Gradation test results are shown in Tables 14 and 15. When compared to the specification gradation, the Quality Level of the materials are low. Although the gradations were not within specification limits; the percent passing for the 12.5 mm (1/2"), 4.75 mm (No. 4), 2.36 mm (No. 8), and 75 µm (No. 200) sieves were fairly uniform, and the volumetric properties of the mixes were considered acceptable.

**Table 14. Quality Level of Gradation Test Results**

Additive	Gradations					
	Quality Level					n
	19.0 mm	12.5 mm	4.75 mm	2.36 mm	75 µm	
Vestoplast S (5.5% AC)	100	55.6	73.6	100	100	4
PM-ID (6.0% AC)	100	71.4	86.4	81.3	91.7	5



**Table 15. Gradation Test Results**

Additive	Gradation Specification				
	Sieve Size (mm) (% Passing)				
	19.0 (100)	12.5 (82-88)	4.75 (28-32)	2.36 (18-22)	.075 (9-11)
** Fibers (6.0% AC)	100	88	32	19	8.0
	100	87	32	20	8.3
** Vestoplast S (5.6% AC)	100	88	30	18	8.3
	100	82	30	19	8.4

\*\* Because of the small quantity of this mixture, only two gradations were taken. Quality Level calculations with less than three tests are not valid.

### 5.1.2 Testing Problems

It was observed by both Staff Materials and the Region Materials testing personnel that testing time for SMA mixes increased over the testing time of CDOT's standard dense graded mixes. In virtually every case, the polymers required more time than the fibers.

The time required to separate the particles for the theoretical maximum specific gravity (AASHTO T 209) increased from 10 minutes for the standard dense graded mixes to 30 minutes for the SMA mixes. The higher asphalt content in the SMA mix resulted in additional time to breakdown the sample to the proper particle size.

Additional time is also required to prepare the sample for AASHTO T 283. Because of the different gradation requirement for the SMA mix, the sample size needs to be adjusted to obtain the proper void content for AASHTO T 283.

Additional time should also be considered to clean up laboratory equipment after SMA testing because of the higher AC percentage. The SMA mixes tend to stick to the equipment more than the standard dense graded mixes.

## 5.2 Volumetrics

Four replicate sample were compacted by the contractor for field quality control. The volumetric test results are shown in Table 16. The most interesting information is the field verification air voids. The SMA was designed between 3.0 and 4.0% air voids and the target was typically 3.5% air voids. As shown in Table 16, the field verification air voids were between 2.0% and 3.0%. Approximately 0.5% to 1.5% air voids were lost during production. It should be noted that field adjustments were made to the SMA with Vestoplast S. The asphalt content was lowered from 5.8% to 5.5% and the air voids increased from 3.0% to 4.0% (Table 16).

There was concern that the low field verification air voids could cause performance problems. So, the SMA was tested in the European torture tests (French rutting tester and Hamburg wheel-tracking device). Test results from the torture tests (see Chapter 6) indicated the SMA was still rut resistant, even with such low field verification air voids. Asphalt content adjustments were not made because the shear strength parameters measured by the European torture tests indicated the SMA was sufficiently strong. It is likely that the high quantity of coarse aggregate can create a stone-on-stone matrix that is rut resistant even at low air voids. The SMA may not follow the same volumetric principles that the standard dense graded mixtures follow.

The CDOT and contractor personnel routinely observed the VMA and Marshall flow throughout the project to monitor the quality of the SMA.

It should be noted that the low air voids may have created a tender mix that was difficult to compact. The reason there were compaction problems in the field may have been associated with the low field verification air voids.

**Table 16. Volumetric Test Results of Field Produced SMA.**

Additive	Air Voids (%)			VMA (%)			Marshall Stability			Marshall Flow		
	Avg	S.D.	n	Avg	S.D.	n	Avg	S.D.	n	Avg	S.D.	n
Fiber 5% Mineral Filler 6% AC	2.2	.34	4	15.4	.33	4	2931	133	4	14	.5	4
Vestoplast S 5% Mineral Filler 5.5% AC	4.0	.59	4	16.2	.47	4	2833	141	4	14	1.3	4
Vestoplast S 5% Mineral Filler 5.8% AC	3.0	*	2	15.8	*	2	3130	*	2	14	*	2
Vestoplast S 7% Mineral Filler 5.5% AC	2.6	.54	7	15.0	.51	7	3129	151	7	13	.8	7
Type I-D Polymer 5% Mineral Filler 5.9% AC	2.0	.97	12	15.0	.84	12	3228	248	12	16	2.0	12

\* Too few samples were tested to calculate the standard deviation.

### 5.3 Comparison of Texas Gyrotory and Marshall Compaction

The CDOT uses the Texas gyratory to design and field verify HMA on a statewide basis. SMA mixes are designed with a 50-blow Marshall. It was desired to determine if the Texas gyratory could be used in lieu of the Marshall hammer.

Twelve samples were compacted with both the Texas gyratory compactor (ASTM D 4013) using a 340 kPa (50 psi) end point stress and the 50-blow Marshall (AASHTO T 245). Regression of the results indicated:

$$y = 0.52x + 1.31$$

where:

y = air voids (%) from the Texas gyratory 340 kPa (50 psi) end point stress, and  
x = air voids (%) from the 50-blow Marshall.

The coefficient of determination,  $r^2$ , was 0.42. The results are shown in Figure 18. The correlation between the two compactors is not very good. If the one outlier is removed, the  $r^2$  is 0.79, and the correlation is quite good. Regression results with the outlier removed indicated:

$$y = 0.93 x + 0.51$$

It should be recognized that any attempt to replace the Marshall hammer with the gyratory compactor will not yield an ideal conversion. If the gyratory is used as a matter of convenience to replace the Marshall hammer, the 340 kPa (50 psi) end point stress appears reasonable. More data should be gathered before making this a specification change for SMA mixtures.

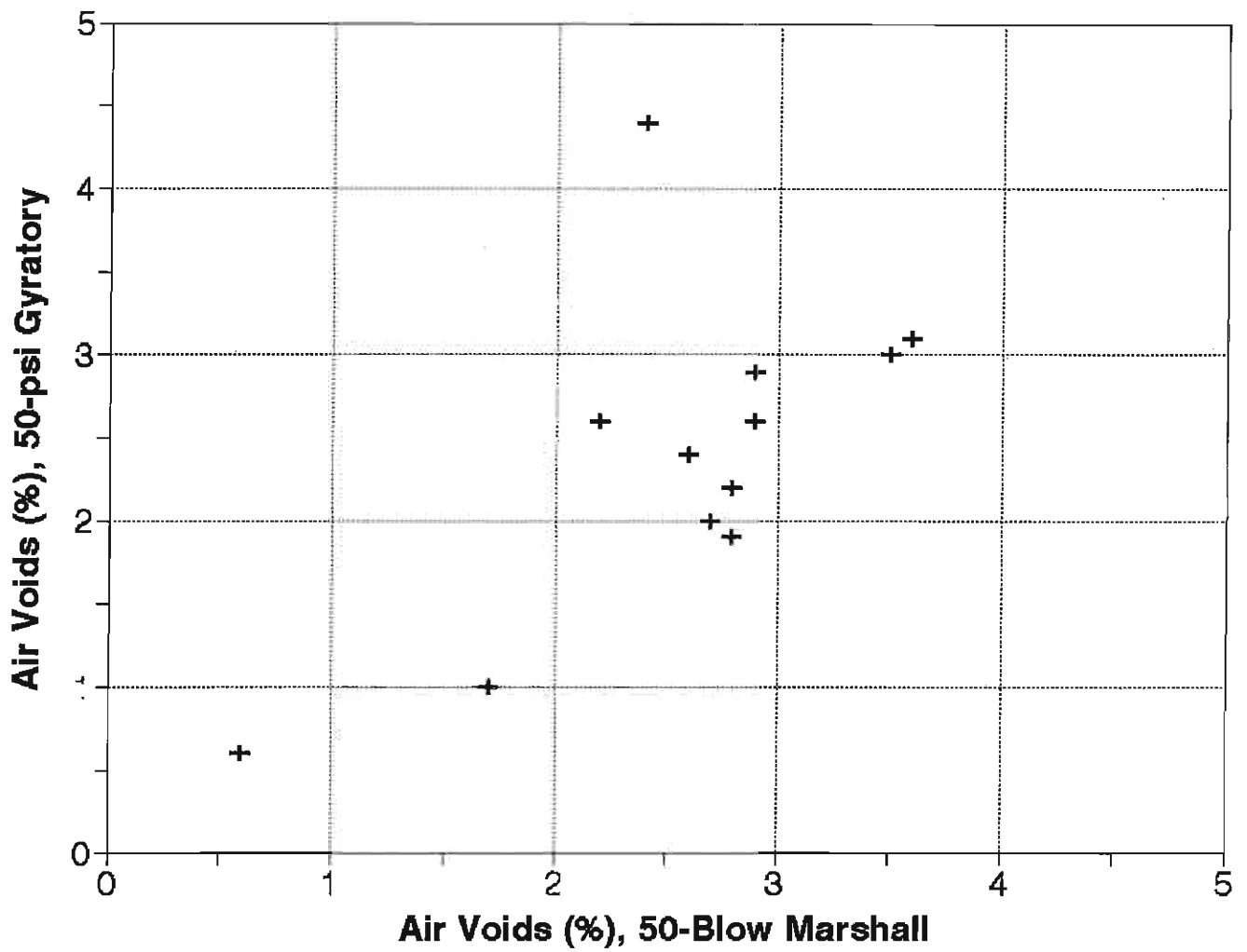

Figure 18. Comparison of Air Voids from Texas Gyrotory and Marshall Compaction.

## 6.0 European Torture Test Results

---

Laboratory tests were performed to identify rutting, moisture damage, and thermal cracking. Fatigue cracking was not investigated in the laboratory as part of this study. It was not part of this study because the test equipment to perform the evaluation was not available. Additionally, cracking of HMA pavements in Colorado is primarily caused by reflective cracks and subgrade failure. Fatigue cracking caused by the HMA material is not very common.

All tests were performed on material that was produced and sampled from the plant. The material tested was placed in the appropriate test section that will be evaluated for long-term performance. Replicate samples were tested and the averages were reported.

### 6.1 Hamburg Wheel-Tracking Device

#### 6.1.1 Description of Test Equipment

The Hamburg wheel-tracking device is used to evaluate the resistance of the HMA to moisture damage. It is manufactured by Helmut-Wind Inc. in Hamburg, Germany as shown in Figures 19 and 20.

A pair of samples are tested simultaneously. A sample is typically 260 mm (10.2 in.) wide, 320 mm (12.6 in.) long, and 40 mm (1.6 in.) deep. A sample's mass is approximately 7.5 kg (16.5 lbs.), and it is compacted to  $6\% \pm 1\%$  air voids. For this study, samples were compacted with the linear kneading compactor. The samples are submerged under water at 50°C (122°F), although the temperature can vary from 25°C to 70°C (77°F to 158°F). A steel wheel, 47 mm (1.85 in.) wide, loads the samples with 705 N (158 lbs.) The wheel makes 50 passes per minute over each sample. The maximum velocity of the wheel is 34 cm/sec (1.1 ft/sec) in the center of the sample. Each sample is loaded for 20,000 passes or until 20 mm of deformation occurs. Approximately 6-1/2 hours are required for a test.

The results from the Hamburg wheel-tracking device include the creep slope, stripping slope and stripping inflection point as shown in Figure 21. These results have been defined by Hines (10). The creep slope relates to rutting from plastic flow. It is the inverse of the rate of deformation

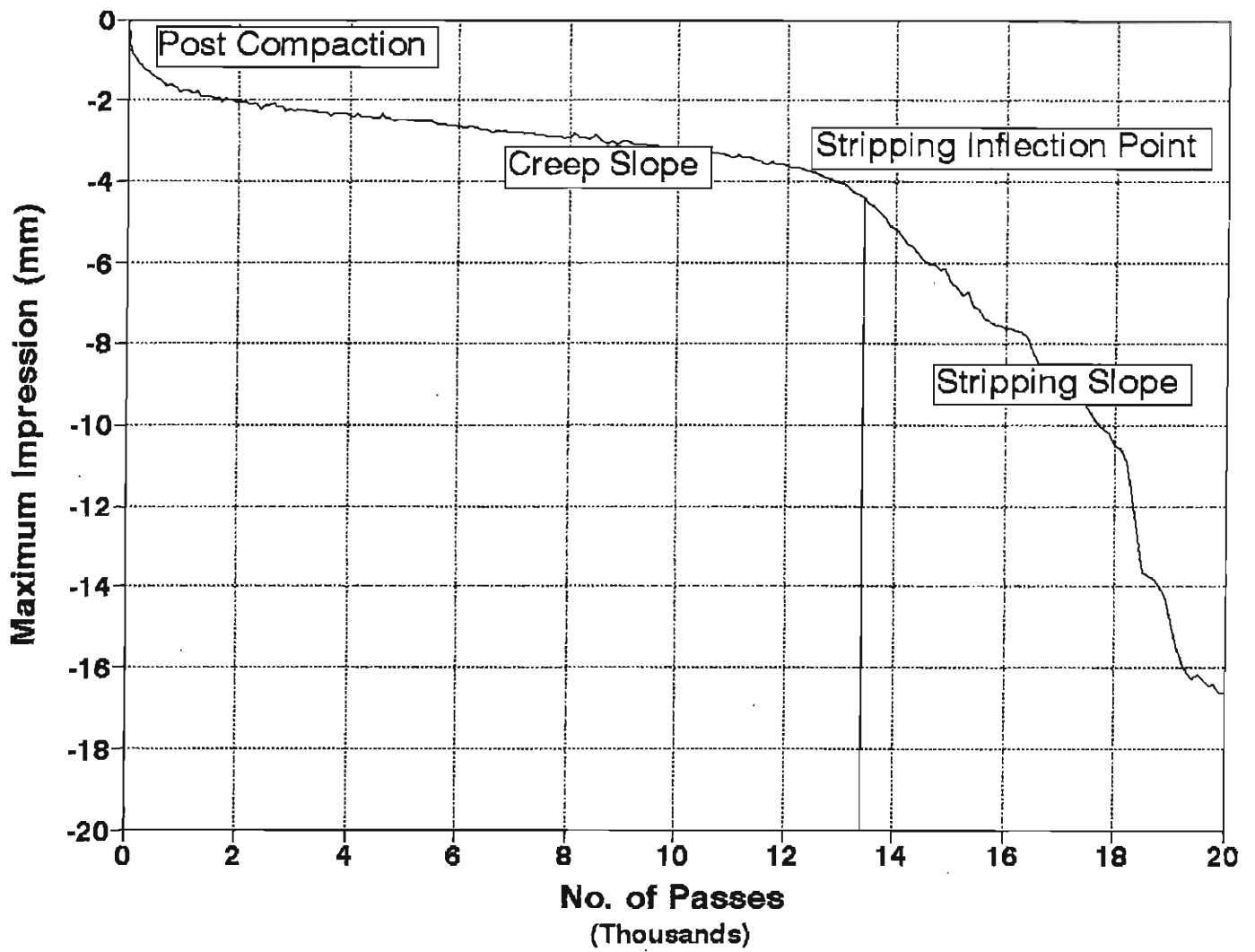

Figure 21. Typical Results from the Hamburg Wheel-Tracking Device.

in the linear region of the deformation curve, after post compaction effects have ended and before the onset of stripping. The stripping slope is the inverse of the rate of deformation in the linear region of the deformation curve, after stripping begins and until the end of the test. It is the number of passes required to create a 1 mm impression from stripping. The stripping slope is related to the severity of moisture damage. The stripping inflection point is the number of passes at the intersection of the creep slope and the stripping slope. It is related to the resistance of the HMA to moisture damage.

**6.1.2 Test Results and Discussion**

A summary of the test results from the Hamburg wheel-tracking device are shown in Table 17. The mm of deformation after 20,000 passes are shown. The results are shown graphically in Appendix C.

**Table 17. Test Results (mm of Deformation After 20,000 Passes) from the Hamburg Wheel-Tracking Device.**

Temperature (°C)	SMA PM-ID	SMA Vestoplast S	SMA Fiber	Grading C AC-20R
45	2.4	2.9	3.2	1.6
50	3.5	10.9	8.2	4.6
55	12.0	>20 (12,000)	>20 (12,000)	>20 (14,000)

(12,000) - number of passes at 20 mm of deformation

Of the SMAs produced for this project, test results indicated the SMA with the PM-ID performed the best. The SMAs modified with Vestoplast S and fiber pellets performed similarly to each other.

The test results from the Grading C were a pleasant surprise. The test results from the Grading C were acceptable and very comparable to the SMA results.

It should be noted that the specification for this project would be a maximum of 10 mm of



deformation at 20,000 passes for samples tested at the 50°C test temperature. All of the material tested from this project would be considered acceptable, even though the Vestoplast S slightly failed the specification.

## 6.2 French Rutting Tester

### 6.2.1 Description of Test Equipment

The French rutting tester is used to evaluate the resistance of the HMA to permanent deformation. It is manufactured by the *Laboratoire Central des Ponts et Chaussées* (LCPC) and is shown in Figure 22; a close-up is shown in Figure 23. The samples tested are 500 x 180 mm (19.7 x 7.1 in.) and can be 50 or 100 mm (2 or 4 in.) thick. Two samples can be tested simultaneously.

The samples are tested by having a tire roll back and forth over the sample at elevated temperatures. The samples are loaded with 5000 N (1124 lbs.) by a pneumatic tire inflated to 0.6 MPa (87 psi). The tires load each sample at 1 cycle per second; one cycle is two passes. The chamber is heated to 60°C (140°F) but can be set to any temperature between 35° and 60°C (95° and 140°F).

When a test is performed on a laboratory compacted sample, it is aged at room temperature for as long as 7 days. It is then placed in the French rutting tester and loaded with 1000 cycles at room temperature. The deformations recorded after the initial loading are the "zero" readings. The sample is then heated to the test temperature for 12 hours before the test begins. Rutting depths are measured after 100, 300, 1000, 3000, 10,000, 30,000 and possibly 100,000 cycles. The rutting depth is reported as a percentage of the sample thickness. After a given number of cycles, the percentage is calculated as the average of 15 measurements (five locations along the length and three along the width) divided by the original slab thickness. A pair of slabs can be tested in about 9 hours.



**Figure 22. French Rutting Tester.**



**Figure 23. Close-Up of the French Rutting Tester.**

A successful test will typically have a rutting depth that is less than or equal to 10% of the slab thickness after 30,000 cycles. The results are plotted on a log-log graph paper. The slope and intercept (at 1000 cycles) are calculated using linear regression. The equation is:

$$Y = A \left( \frac{X}{1000} \right)^B \quad (\text{Equation 1})$$

where:

Y = rutting depth (%),

X = cycles,

A = intercept of the rutting depth at 1000 cycles, and

B = slope of the curve.

### 6.2.2 Test Results and Discussion

A summary of the test results from the French rutting tester are shown in Table 18. The percent rut depth after 30,000 cycles is shown. The results are shown graphically in Appendix D.

Table 18. Test Results (% Rut Depth After 30,000 Cycles) from the French Rutting Tester.

Temperature (°C)	SMA PM-ID	SMA Vestoplast S	SMA Fiber	Grading C AC-20R
60	4.3	3.6	4.2	3.4

Test results indicated all of the SMAs will be rut resistant. The Grading C was also very rut resistant.

## 6.3 Thermal-Stress, Restrained-Specimen Test

### 6.3.1 Description of Test Equipment

The thermal stress restrained specimen test (TSRST) is used to evaluate the resistance of the HMA to low temperature thermal cracking. The TSRST was developed at Oregon State University as part of SHRP. The TSRST is manufactured by OEM, Inc. in Corvallis, Oregon.

The device is shown in Figures 24 and 25. A schematic of the sample is shown in Figure 26. The device is fully automated.

Vinson (11) evaluated numerous tests used to identify the low-temperature thermal cracking characteristics of HMA. Based on the evaluation, the TSRST as modified by Arand (12) was determined to be the best. This test has been evaluated by Jung (13, 14).

The loose HMA was short-term aged for 4 hours at 135°C (270°F) and then compacted. Samples were compacted in the linear kneading compactor for this study. The compacted HMA was then long-term aged for 120 hours (5 days) at 85°C (185°F) in a forced draft oven. Samples tested were 50-mm (2-in.) diameter and 250-mm (10-in.) long.

After a sample is mounted in the TSRST, it is cooled at a rate of 10°C (18°F) per hour. Liquid Nitrogen is used to provide the cooling. The sample is not allowed to contract during the cooling period. The sample length is monitored with LVDTs and the use of Invar steel rods. Since the sample is not allowed to contract as it cools, stresses develop within it. A closed-loop system keeps the sample at a constant length. When the developed stress exceeds the strength of the sample, the sample breaks. The temperature and stress at fracture are recorded. A typical plot of the test results is shown in Figure 27.

The repeatability of the test was studied by Jung (14). The coefficient of variation was 10% for the fracture temperature and 20% for the fracture strength. This was considered to be excellent and reasonable, respectively. One standard deviation, 68%, of replicate samples will have a fracture temperature within  $\pm 2$  or  $3^\circ\text{C}$  ( $\pm 4$  or  $5^\circ\text{F}$ ). Likewise,  $\pm 400$  to  $600$  kPa ( $\pm 60$  to  $90$  psi) would be representative of fracture stresses of 68% of identical samples.



Figure 24. The TSRST Device.

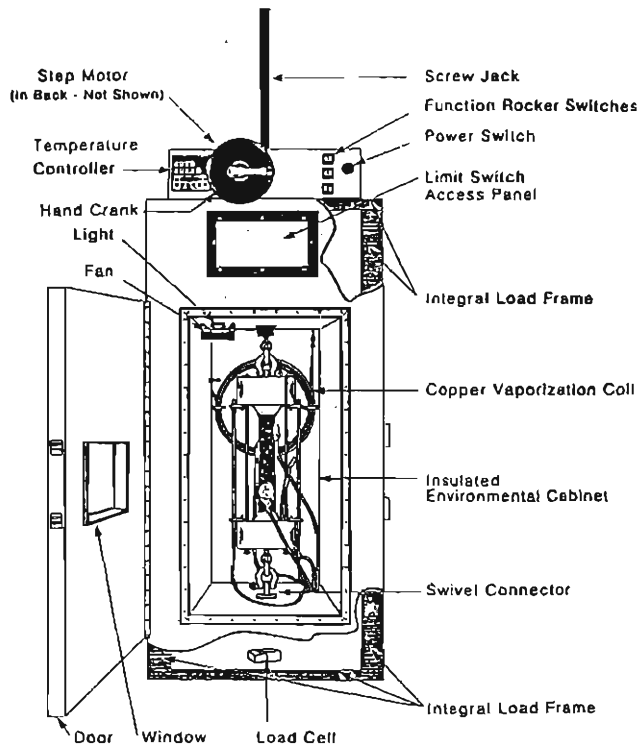

Figure 25. Schematic of the TSRST Device.

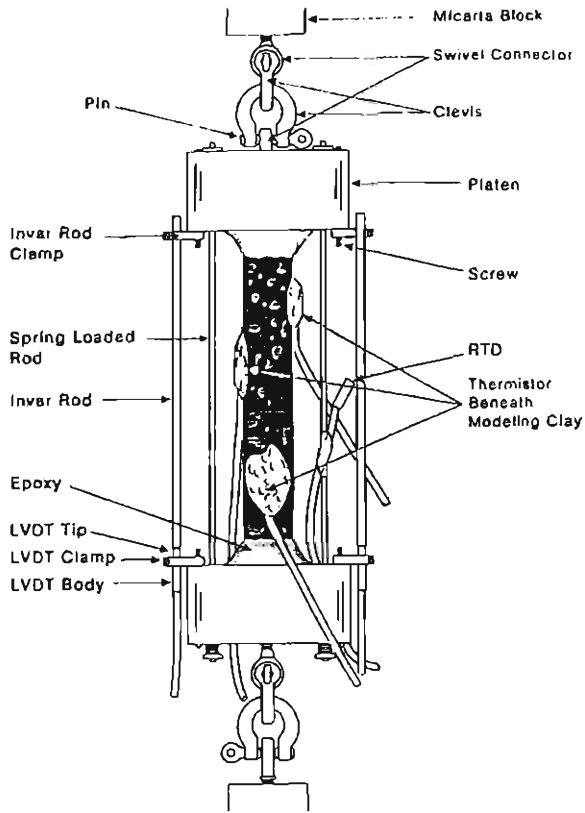

Figure 26. Schematic of the Test Sample.

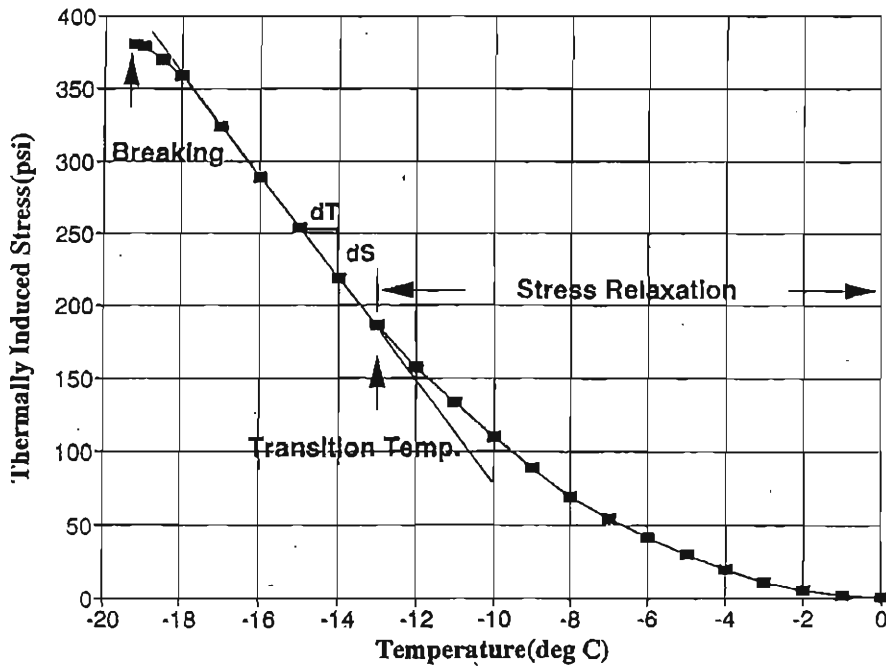

Figure 27. Typical TSRST Test Results.

### 6.3.2 Test Results and Discussion

The fracture temperature and fracture strength of each of the mixtures tested are shown in Table 19. The PM-ID sample did the best. It had the lowest fracture temperature and highest fracture strength than any of the others. Although the Vestoplast S improved the binder as much as the PM-ID based on the DSR results for high temperature, the Vestoplast S did not improve the low temperature thermal cracking performance. Additionally, the fiber stiffened the binder significantly at high temperatures based on the DSR results, but the fibers provided no improvement at low temperatures. Finally, the Grading C with AC-20R did surprisingly well.

Table 19. TSRST Test Results.

	Fracture	
	Temperature (°C)	Strength (kPa)
SMA PM-ID	-33	4360
SMA VS	-23	3020
SMA Fiber	-20	2670
Grading C	-30	2340

VS - Vestoplast S

PM-ID - Polymer Modified, Type I-D

## 6.4 Comparison of Mixtures

Based on test results from the French rutting tester and the Hamburg wheel-tracking device, all three of the SMAs performed excellently. Based on test results from the TSRST, the PM-ID provided significant improvement over the other two additives. The Vestoplast S did slightly better than the fiber pellets in the TSRST, but the fibers did slightly better than the Vestoplast S in the Hamburg wheel-tracking device.

Based on the European tests, the additives should be ranked from first to third as 1) PM-ID, 2) Fibers and Vestoplast S (tie). It should be noted that all additives performed acceptably.

## **7.0 Comparison of SMAs with Different Additives**

Three different additives were used with the SMAs. An evaluation of the additives was made based upon constructability, field testing, laboratory performance testing, and cost. The results are summarized in Table 20, from most desirable in each category (1) to least desirable in each category (3).

Constructability was determined by the contractor. It was defined as the ease of placement and workability, and ease of production at the plant was included. The contractor indicated the fiber pellets additives worked the best. The SMA with fiber pellets was the easiest to work with at the paver, and clean-up in the haul trucks was also easiest. The PM-ID was the next easiest. The advantage of the PM-ID was that the asphalt cement modified with the additive was delivered directly to the plant, and the contractor did not have to modify the plant.

Field testing was determined by the CDOT and contractor quality control and assurance testers. It was defined as the ease of testing and clean-up. The tests included the standard asphalt content and gradation tests as well as the Marshall tests used for volumetric control. The SMA modified with fiber pellets was considered the easiest to work with and clean-up after testing.

The laboratory performance testing was measured with the European testing equipment described in Chapter 6 and the SHRP binder tests in Section 3.2. The laboratory performance of all of the three additives were considered acceptable. The PM-ID did significantly better in the TSRST than the Vestoplast S and fiber pellets.

The cost was defined by the bid cost of the low bidder for this project. The bid costs are shown in Table 1 in Section 2.3.

Three different additives were used on the project (fiber pellets, Vestoplast S, and PM-ID). The use of each of the additives was considered successful. Based on constructability, laboratory performance testing, and cost; the additives were rated from first to third as: 1) fiber pellets, 2) PM-ID, and 3) Vestoplast S.



In future specifications, the traffic level should be considered when specifying the additives. On high volume roadways, SHRP Performance Graded binder specification should be required. This will likely require polymers, or possibly a fiber/polymer blend. The goal will be to meet the SHRP Performance Graded binder specification and prevent draindown. On low volume roadways, all three of the additives should be allowed, so the contractor can select the one additive that the contractor is most comfortable using. This will likely be fibers since they are the least expensive.

**Table 20. Comparison of the Different Additives Used In SMA.**

Rank	Construction	Field Testing	Laboratory Performance	Cost
1	Fiber	Fiber	PM-ID	Vestoplast S
2	PM-ID	PM-ID	Vestoplast S Fiber *	Fiber
3	Vestoplast S	Vestoplast S		PM-ID

\* - Tie

It should be noted that in projects throughout the country, the Vestoplast S was added just as easily as the fiber pellets. However, for this project, the contractor elected to use a grain auger instead of a conveyor belt and encountered significant problems. The problems with adding Vestoplast S on this project may not be the same as those encountered elsewhere if the manufacturer's recommendations are followed.

## **8.0 Summary and Recommendations**

The Stone Matrix Asphalt (SMA) experimental feature on project NH 1191-005, from SH-52 East to Longmont, is CDOT's first attempt under contract to construct test sections for evaluation. The project successfully demonstrated the design, production, and placement of the European SMA.

The research experiment on the project consisted of placing 11,000 tonnes of SMA using three different mix designs (two polymer stabilized mixtures and one fiber mixture). The two polymers were Vestoplast S from Huls America and PM-ID from Koch Materials Co. The fiber mixture used a cellulose fiber in pellet form from Arbocel.

### **8.1 Design**

- 1) The specifications used for the design of the SMA were adequate with a few exceptions.
- 2) Asphalt contents were lower than expected. The specified VMA should be increased to the level recommended by the FHWA (6). This will set a higher minimum asphalt content.
- 3) The Master Range should be widened to that recommended by the FHWA (6). This will allow the contractor more flexibility in blending the aggregates to achieve the required VMA.
- 4) AASHTO T 283 may not be applicable to SMA mixtures. SMAs with two of the additives (Vestoplast S and fiber) failed the CDOT specification, while one of the additives (PM-ID) barely passed. All three of the SMA mixtures did extremely well in the Hamburg wheel-tracking device.
- 5) The use of the Texas gyratory compactor with a 340 kPa (50 psi) end point stress should be reasonably comparable to the 50-blow Marshall. More data should be gathered before making this a specification change for SMA mixtures.
- 6) Three different additives were used on the project (fiber pellets, Vestoplast S, and PM-ID). The use of each of the additives was considered successful. Based on constructability, laboratory performance testing, and cost; the additives were rated from first to third as: 1) fiber pellets, 2) PM-ID, and 3) Vestoplast S.

In future specifications, the traffic level should be considered when specifying the additives. On high volume roadways, SHRP Performance Graded binder specification should be required. This will likely require polymers, or possibly a fiber/polymer blend. The goal will be to meet the SHRP Performance Graded binder specification and prevent draindown. On low volume roadways, all three of the additives should be allowed, so the contractor can select the one additive that the contractor is most comfortable using. This will likely be fibers since they are the least expensive.

## 8.2 Construction

1) During production, the SMA had low field verification air voids. Results from the torture tests (French rutting tester and Hamburg wheel-tracking device) indicated that the low air voids will not cause a problem with field performance due to rutting or moisture damage. It is likely that the high quantity of coarse aggregate can create a stone-on-stone matrix that is rut resistant even at low air voids. The SMA may not follow the same volumetric principles that the standard dense graded mixtures follow.

2) The rollers need to be kept very close to the paver, and a well-established roller pattern needs to be followed. It was still not possible to achieve 94% relative compaction throughout the project. The rollers should have been used more efficiently, or better SMA mixture specifications could have yielded a more compactable mix. Both static and vibratory compactors were demonstrated.

3) Several plant modifications were required to add the mineral filler and additives. Production through the plant was reduced significantly because of the addition of mineral filler; the contractor did not use a large enough feed line. The rate of production was virtually cut in half from the normally expected 250 tonnes per hour to 150 tonnes per hour.

4) Although the PM-ID did not pass the draindown test in the laboratory, there were no draindown problems in the field. The laboratory criteria for draindown needs to be re-evaluated.

### **8.3 Performance**

1) Field performance data will be evaluated on an annual basis. Results will be available in approximately 3 years.

2) Based on the European torture tests, it is expected that the SMAs will have very good field performance with respect to rutting and moisture damage.

## 9.0 Future Research

---

The costs of the three SMAs produced and placed for this study ranged from \$54 to \$63 per ton in place. This high cost reflects the relative small quantities, the uncertainties of the first time production of SMA, the plant retro-fitting described in Chapter 4 and costs associated with the required technical session and open house.

CDOT should continue to evaluate other applications of SMA. SMA mixes are dense graded, impermeable, and can be placed in thin lifts. Even though the SMA structure is dense it provides an open-graded surface allowing water to drain rapidly from the surface and provides a high skid resistant surface. These qualities provide for an excellent wearing surface.

A SMA mix is an alternative method for rehabilitating pavements that are structurally sound but with a deteriorating surface (such as loss of skid or rutting from wear). Future research should include evaluating SMAs for rehabilitation of existing pavements meeting this criteria. An example would be in an urban area where thin lifts could be utilized eliminating the need for extensive milling.

Other applications might include using SMA mixes for bridge overlays. SMAs can be placed in thinner lifts thereby reducing the depth of required milling. This eliminates any potential damage to the deck membrane.

Although the average bid price of a ton of SMA is approximately twice that of a ton of dense-graded HBP, potential savings could be realized using SMAs as a wearing course. It is anticipated that with an increase use of SMA the cost will decrease. For example, on the first experimental project in Maryland, the cost was \$55 to 60 per ton. However, last year, Maryland placed approximately 300,000 tons of SMA and the cost was about \$35 per ton.

## 10.0 References

---

1. Report on the 1990 European Asphalt Study Tour (June 1991), American Association of State Highway and Transportation Officials, Washington, D.C., 115+ pages.
2. Scherocman, J.A. (1992), "Construction of Stone Mastic Asphalt Test Sections in the U.S.," *Journal of the Association of Asphalt Paving Technologists*, Volume 61, pp. 642-664.
3. Scherocman, J.A. (1994), "SMA Learning," *Asphalt Contractor*, September-October, pp. 46-72.
4. Scherocman, J.A. (1994), "The SMA Learning Curve has been Steep in the U.S.," *Asphalt Contractor*, November, pp. 42-75.
5. Shuler, T.S., Chairman (1991), AASHTO-AGC-ARTBA Joint Committee, Subcommittee on New Materials, Task Force 31, "Proposed Specifications for Polymer Modified Asphalt," 18 pages.
6. Guidelines for Materials, Production, and Placement of Stone Matrix Asphalt (SMA) (August 1994), National Asphalt Pavement Association, Information Series 118, 18 pages.
7. Anderson, D.A. (1987), "Guidelines on the Use of Baghouse Fines," National Asphalt Pavement Association, Information Series 101-11/87, 31 pages.
8. Criteria for Use of Asphalt Friction Surfaces 104 (1983), National Cooperative Highway Research Program Synthesis of Highway Practice, Transportation Research Board, 41 pages.
9. Meeting Minutes November 16 and 17, 1993 SMA Technical Working Group, 11 pages.
10. Hines, Mickey (1991), "The Hamburg Wheel-Tracking Device," Proceedings of the Twenty-Eighth Paving and Transportation Conference, Civil Engineering Department, The University of New Mexico, Albuquerque, New Mexico.
11. Vinson, T.S., V.C. Janoo, and R.C.G. Haas (1989), "Low Temperature and Thermal Fatigue Cracking," SHRP Summary Report SR-OSU-A-003A-89-1.
12. Arand, W. (1987), "Influence of Bitumen Hardness on the Fatigue Behavior of Asphalt Pavements of Different Thickness Due to Bearing Capacity of Subbase, Traffic Loading, and Temperature," Proceedings of the 6th International Conference on Structural Behavior of Asphalt Pavements, University of Michigan, Ann Arbor, pp. 65-71.

13. Jung, D. and T.S. Vinson (1993), "Thermal Stress Restrained Specimen Test To Evaluate Low-Temperature Cracking of Asphalt-Aggregate Mixtures," Transportation Research Record 1417, Transportation Research Board, Washington, D.C., pp. 12-20.
14. Jung, D. and T.S. Vinson (1993), "Low Temperature Cracking Resistance of Asphalt Concrete Mixtures," Journal of the Association of Asphalt Paving Technologists, Volume 62, pp. 54-92.

**Appendix A:  
SMA Specifications.**



April 26, 1994

REVISION OF SECTIONS 401, 403, AND 703  
STONE MASTIC ASPHALT PAVEMENT

Sections 401, 403, and 703 of the Standard Specifications and Standard Special Provisions are hereby revised for this project as follows:

Subsection 401.02 shall include the following:

Recycled Asphalt Pavement (RAP) shall not be used in Stone Mastic Asphalt (SMA) mix.

Subsection 401.02, Table 401-1 shall include the following:

\*\*Stone Mastic Asphalt Pavement - Item 403

Passing 1/2" sieve	± 5%
Passing No. 4 and No. 8 sieves	± 4%
Passing No. 200 sieve	± 2%

The temperature requirement at the time of discharge in Table 401-1 shall not apply to stone mastic asphalt pavements.

In subsection 401.02, second paragraph, delete items (1) and (2) and replace with the following:

- (1) A proposed job-mix gradation for each mixture required by the Contract, except stone mastic asphalt (SMA) mix, which shall be wholly within the master range table, Table 703-3 or 703-6, before tolerances shown in Table 401-1 are applied. Also, a proposed job-mix gradation for SMA mixes required by the Contract which shall be wholly within the master range table, 703-3, before the tolerances shown in Table 401-1 for stone mastic asphalt pavement - Item 403 are applied. The weight of lime shall be included in the total weight of the material passing the No. 200 sieve.
- (2) The aggregate source, percentage of each element used in producing the final mix, the gradation of each element, and the proposed job mix formula (JMF) gradation. The gradation used shall be based on the Contractor's JMF. Before the design is performed, adjustments to the gradation of each element as determined by the Division shall be made only on the aggregates retained on the No. 4 sieve or larger.

When approved, laboratory test results submitted by the Contractor may be used to modify the mixing and compaction temperatures for SMA mixtures. Except for the VESTOPLAST-S, the minimum mixing temperature shall be that at which the kinematic viscosity is a maximum of 350 centistokes. The minimum compaction temperature shall be that at which the kinematic viscosity is a maximum of 1000 centistokes.

-3-

REVISION OF SECTIONS 401, 403, AND 703  
STONE MASTIC ASPHALT PAVEMENT

3-Ash Content:	18% (+/- 5%) non-volatiles
4-Ph:	7.5 (+/- 1.0)
5-Oil Absorption:	5.0 (+/- 1.0) (times fiber weight)
6-Moisture Content:	< 5% (by weight)

- 1 **Method A - Alpine Sieve Analysis.** This test is performed using an Alpine Air Jet Sieve (Type 200 LS). A representative five gram sample of fiber is sieved for 14 minutes at a controlled vacuum of 22 inches (+/-3) of water. The portion remaining on the screen is weighed.
- 2 **Method B - Mesh Screen Analysis.** This test is performed using standard Nos. 20, 40, 60, 80, 100, and 140 sieves, nylon brushes and a shaker. A representative 10 gram sample of fiber is sieved, using a shaker and two nylon brushes on each screen. The amount retained on each sieve is weighed and the percentage passing calculated.
- 3 **Ash Content.** A representative 2-3 gram sample of fiber is placed in a tared crucible and heated between 1100 and 1200 F for not less than two hours. The crucible and ash are cooled in a desiccator and reweighed.
- 4 **Ph Test.** Five grams of fiber is added to 100 ml of distilled water, stirred and let sit for 30 minutes. The Ph is determined with a probe calibrated with Ph 7.0 buffer.
- 5 **Oil Absorption Test.** Five grams of fiber is accurately weighed and suspended in an excess of mineral spirits for not less than five minutes to ensure total saturation. It is then placed in a screen mesh strainer (approximately 0.5 square millimeter hole size) and shaken on a wrist action shaker for ten minutes (approximately 1-1/4 inch motion at 240 shakes/minute). The shaken mass is then transferred without touching, to a tared contained and weighed. Results are reported as the amount (number of times its own weight) the fibers are able to absorb.
- 6 **Moisture Content.** Ten grams of fiber is weighed and placed in a 250 F forced air oven for two hours. The sample is then reweighed immediately upon removal from the oven. (Moisture Content = (Original Fiber Weight - Oven Dry Weight)/Oven Dry Weight)

FIBER PROPERTIES

Mineral (Basalt) Fibers

-Size Analysis:	
1 Fiber Length:	0.04 inches +/- 0.01 inches
2 Thickness:	0.0002 inches +/- 0.0001 inches

-4-

REVISION OF SECTIONS 401, 403, AND 703  
STONE MASTIC ASPHALT PAVEMENT

3-Shot Content:	No. 60 sieve	90% passing (+/- 5%)
	No. 230 sieve	70% passing (+/- 10%)

- 1 The fiber length is determined according to the Bauer McNett fractionation.
- 2 The fiber diameter is determined by measuring at least 200 fibers in a phase contrast microscope.
- 3 Shot content is a measure of non-fibrous material. The shot content is determined on vibrating sieves. Two sieves, No. 60 and No. 230 are typically utilized, for additional information see ASTM C612.

Note: For the VESTOPLAST-S the dry mixing time is 5 seconds total. The wet time is same as above. VESTOPLAST-S is added to the pugmill at the start of the dry cycle. Quantity: VESTOPLAST-S shall be 7% by weight of the liquid asphalt cement required for the mix. This 7% replaces an equal amount of asphalt cement.

For drum plant operations, the following alternate can be used:

Cellulose bitumen granulate 66/34 meeting the cellulose fiber properties can be used.

Note: Cellulose bitumen granulate and VESTOPLAST-S shall be added through RAP inlet.

\*The producer shall provide certified test results.

All additive representatives shall be present at the time of start up for technical assistance.

Subsection 401.07 shall include the following:

Placement of SMA shall be permitted only when minimum air and surface temperatures are 50°F. or above.

Subsection 401.09 shall include the following:

The time between plant mixing and placement of SMA shall not exceed one hour. Each load shall be covered with a full tarp extending a minimum of 6 inches over the sides of the truck and securely fastened.

Subsection 401.15 shall include the following:

All SMA pavements, except those containing polymer modified (Type I-D) asphalt cements, shall have a mixture temperature at the time of placement between 275°F. and 310°F.

-5-

REVISION OF SECTIONS 401, 403, AND 703  
STONE MASTIC ASPHALT PAVEMENT

Subsection 401.17 shall include the following:

Compaction of SMA shall be accomplished using a minimum of two steel wheel rollers weighing 10 to 12 tons. Additional steel wheel rollers may be required by the Engineer. The initial breakdown roller shall follow the laydown operation as closely as feasible. All rollers must operate within 500 feet of the paver. The Engineer must approve, and may request changes in this distance. In-place density shall comply with subsection 401.17 except the minimum acceptable level shall be 94 percent of voidless density. Price adjustments shall not apply.

Rollers shall not be used in a vibratory mode unless they are first used successfully in the demonstration control strip. Pneumatic wheel rollers shall not be used on SMAP mix. Roller speed shall be between 1 and 3 mph.

Compaction in test sections using the AC-20P modified asphalt shall be completed before the mix cools down to 275°F. and for VESTOPLAST-S 240°F.

The method of measuring relative compaction for all SMA mixtures will be in accordance with CP-44 Method B (cores).

In-place density shall be expressed as a percentage of the maximum specific gravity determined for each lot of material.

Subsection 403.02 shall include the following:

Mixture design and field control testing of SMA shall be performed using the Marshall Method (AASHTO T-245-90).

A minimum of two weeks prior to the proposed use of any stone mastic asphalt pavement on the project, the Contractor shall submit to the Engineer a mix design meeting the appropriate specification requirements, including the following:

Stability, Marshall Compactor (50 blow)	1200 lbs. minimum
% Voids in total mix	3-4%
VMA (% voids in aggregate)	15
Flow	0.10 inches to 0.18 inches
Lottman, CPL 5109	80
Dry Tensile Strength, PSI, Min. CPL 5109	30

The three SMA designs must be approved by the Engineer before any pavement is placed on the project. In addition the Contractor will provide field control testing during production of all mixtures used in the test sections. The following tests will be required for each design mix and their results provided to the Project Engineer during production:

REVISION OF SECTIONS 401, 403, AND 703  
STONE MASTIC ASPHALT PAVEMENT

TEST	FREQUENCY
Stability	1/400 ton or fraction there of
Flow	1/400 ton or fraction there of
% Voids in total mix	1/400 ton or fraction there of
VMA, (% voids in mineral aggregate)	1/400 ton or fraction there of
Lottman, CPL 5109	1/mix design
Dry Tensile Strength, PSI, CPL 5109	1/mix design

The person responsible for the SMA mixture designs and field control tests and the technicians performing them shall be identified at the preconstruction conference. The person responsible must possess one or more of the following qualifications:

1. Registration as a Professional Engineer in the State of Colorado
2. NICET certification at Level II or higher in the subfield of Highway Materials or Asphalt, Concrete and Soils.
3. A minimum of five years testing experience with soils, asphalt pavement and concrete.

Technicians performing the tests shall have previous design experience with the Marshall Method and must possess one or more of the following:

1. A minimum of two years testing in the specialty field.
2. Certification by a nationally recognized organization such as NICET.
3. For the appropriate specialty field, Certification by the American Concrete Institute (ACI), or by the Colorado Asphalt Producers Association (CAPA).

Subsection 403.03 shall include the following:

This work includes placing a Stone Mastic Asphalt (SMA) pavement in test sections as shown on the plans. Before proceeding with the actual work, the Contractor shall demonstrate the ability to produce and place a satisfactory mix. The actual work may proceed when a full lane width demonstration control strip, having a minimum length of 400 feet, has been successfully placed. The control strip will be used by the Engineer to determine the compactive effort required for density. No other SMA production and placement will be allowed until densities are determined. The SMA used in the demo control strip will be produced and placed using AC-20P. The control strip will be placed in a bottom lift of pavement. The Contractor will designate the location when he submits to the Engineer his paving schedule for the test strip and the Stone Mastic Asphalt Pavement demonstration.

-7-

REVISION OF SECTIONS 401, 403, AND 703  
STONE MASTIC ASPHALT PAVEMENT

Tack coat between the existing pavement and SMA shall be placed at a rate between 0.03 and 0.05 gallons per square yard.

Subsection 403.04 shall include the following:

Stone mastic asphalt pavement will be measured by the ton.

Subsection 403.05 shall include the following:

<u>Pay Item</u>	<u>Pay Unit</u>
403 - Stone Mastic Asphalt (Vesto Plast) (Asphalt)	Ton
403 - Stone Mastic Asphalt (Fibers) (Asphalt)	Ton
403 - Stone Mastic Asphalt (Asphalt) (Polymer Modified)	Ton

Payment for Stone Mastic Asphalt Pavement will be full compensation for demonstrating, furnishing, hauling, preparing, and placing all materials, hydrated lime, tack coat, and approved control strip; for labor, equipment, tools, setting of lines and guides where specified, and incidentals necessary to complete the item.

Subsection 703.04 shall include the following: Coarse Aggregate:

Aggregate for Stone Mastic Asphalt Pavement shall conform to the following:

Coarse aggregate for SMA shall meet the requirements of this subsection with the following additions:

- 1) L.A. Abrasion Loss (AASHTO T96) 30% max
- 2) Sodium Sulphate Soundness Loss (AASHTO T104) 12% max

100% crushed gravel shall be used in SMA mix. A minimum of 90% of the materials retained on the #4 screen shall have two or more fractured faces. Aggregates used in SMA shall be from a single source.

Fine Aggregate: Fine aggregate shall meet the following requirements:

Sodium Sulphate Soundness Loss (5 cycles, AASHTO T109) 12% max

Fine aggregate shall consist of 100 percent crushed aggregate and shall be nonplastic (AASHTO T 90).

-8-

REVISION OF SECTIONS 401, 403, AND 703  
STONE MASTIC ASPHALT PAVEMENT

Subsection 703.04, Table 703-3 shall include the following:

Sieve Size	Grading SMAP
3/4"	100
1/2"	82-88
3/8"	
#4	28-32
#8	18-22
#16	
#30	
#50	
#100	
#200	9-11

Subsection 703.06 shall include the following:

Mineral filler for the Stone Mastic Asphalt pavement shall be hydrated lime, rock, or limestone dust and shall meet the requirements of this subsection and the following:

Plasticity Index (AASHTO T-90) 4% max.

The Contractor shall submit hydrometer analysis (AASHTO T88) for mineral filler. The Contractor shall submit test number along with the reference used to perform hydrometer analysis.

The mineral filler shall be stored in a silo and added automatically in the correct proportion. The mineral filler shall be added at the point the asphalt cement is added.

**Appendix B:**  
**Locations of Various SMA Mixtures.**



Date Paved	Quantity (Tons)	SMA Type	% AC	Sta to Sta	Location	Layer
8/26/94	200	PM-1D	6.0	508+12 - 495+00	SB RT SHLDR	BOT
8/29/94	200	PM-1D	6.0	495+00 - 481+72	SB RT SHLDR	BOT
	428	PM-1D	5.8	508+00 - 481+72	SB RT LANE	BOT
8/30/94	658	PM-1D	5.8	508+00 - 481+72	SB LT LANE	BOT
	602	PM-1D	5.8	508+00 - 486+00	SB LT LANE	TOP
8/31/94	100	VESTO	5.8	482+50 - 472+00	SB RT SHLDR	BOT
	200	VESTO	5.6	472+00 - 465+00	SB RT SHLDR	BOT
9/1/94	275	VESTO	5.6	465+00 - 455+32	SB RT SHLDR	BOT
	650	VESTO	5.6	481+72 - 455+20	SB RT LANE	BOT
	275	VESTO	5.6	481+72 - 468+25	SB LT LANE	BOT
	100	VESTO	5.4	464+00 - 458+00	SB LT ACCEL LANE	BOT
9/2/94	300	VESTO	5.6	468+22 - 456+00	SB LT LANE	BOT
9/14/94	756	PM-1D	5.8	402+00 - 428+92	NB RT LN & SHLDR	TOP
	398	PM-1D	5.8	508+12 - 486+00	SB RT LANE	TOP
9/15/94	691	PM-1D	5.8	402+52 - 428+92	NB LT LANE	TOP
	337	PM-1D	5.8	508+12 - 485+00	SB RT SHLDR	TOP
	428	VESTO	5.6	482+00 - 458+00	SB RT SHLDR	TOP
	67	VESTO	5.4	458+00 - 451+75	SB RT SHLDR	TOP
9/16/94	245	VESTO	5.5*	486+00 - 469+75	SB RT LANE	TOP
9/23/94	284	VESTO	5.5*	469+75 - 452+50	SB RT LANE	TOP
	228	VESTO	5.5*	473+75 - 456+25	SB LT ACCEL LANE	TOP
	309	VESTO	5.5*	486+00 - 476+00	SB LT LANE	TOP
9/26/94	553	VESTO	5.5*	376+00 - 402+52	NB LT LANE	TOP
	383	VESTO	5.5*	376+00 - 402+52	NB RT LANE	TOP
	345	VESTO	5.5*	476+00 - 453+75	SB LT LANE	TOP
9/27/94	333	VESTO	5.5*	376+00 - 402+25	NB RT SHLDR	TOP
	93	VESTO	5.5*	429+72 - 434+25	NB RT SHLDR	TOP
	292	FIBERS	6.0	434+25 - 455+50	NB RT SHLDR	TOP
9/28/94	453	FIBERS	6.0	428+92 - 454+25	NB RT LANE	TOP
	659	FIBERS	6.0	428+92 - 455+75	NB LT LANE	TOP

\* 7% mineral filler in lieu of 5%

**Appendix C:  
Hamburg Wheel-Tracking Device Test Results.**

SMA, FIBER  
Temperature = 45 C

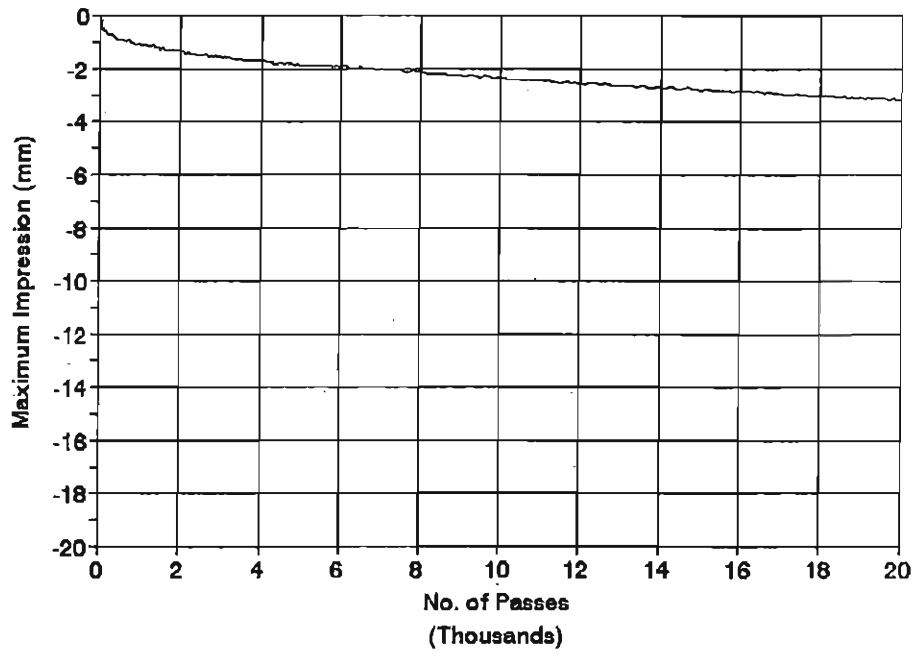

Profiles  
Temperature = 45 C

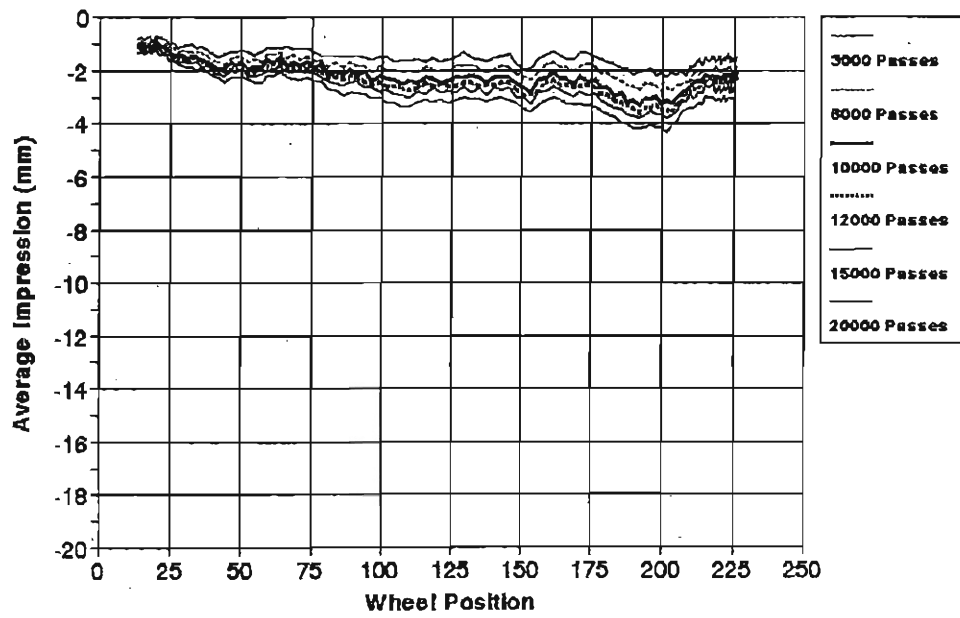

SMA, FIBER  
Temperature = 50 C

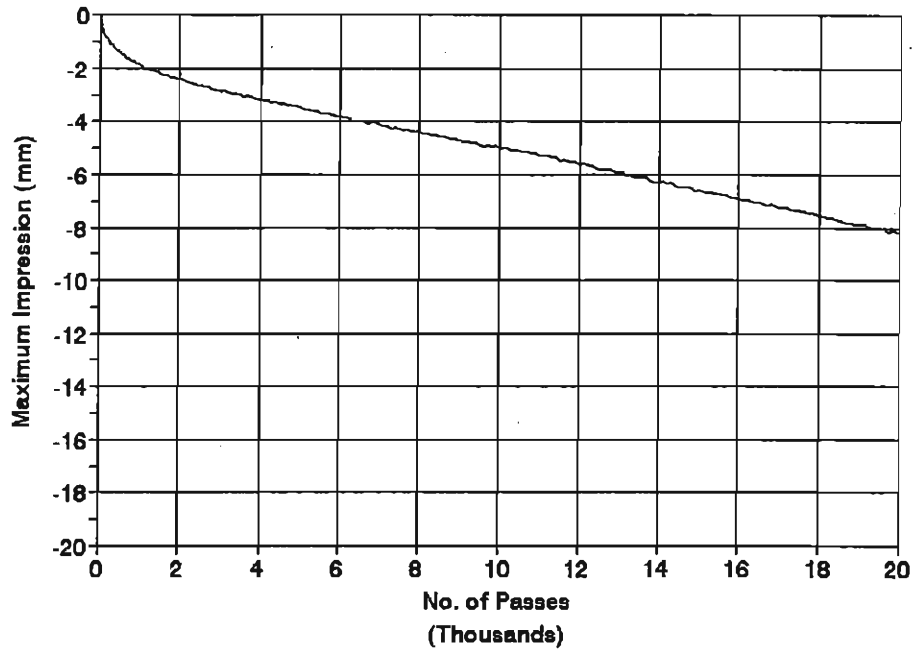

Profiles  
Temperature = 50 C

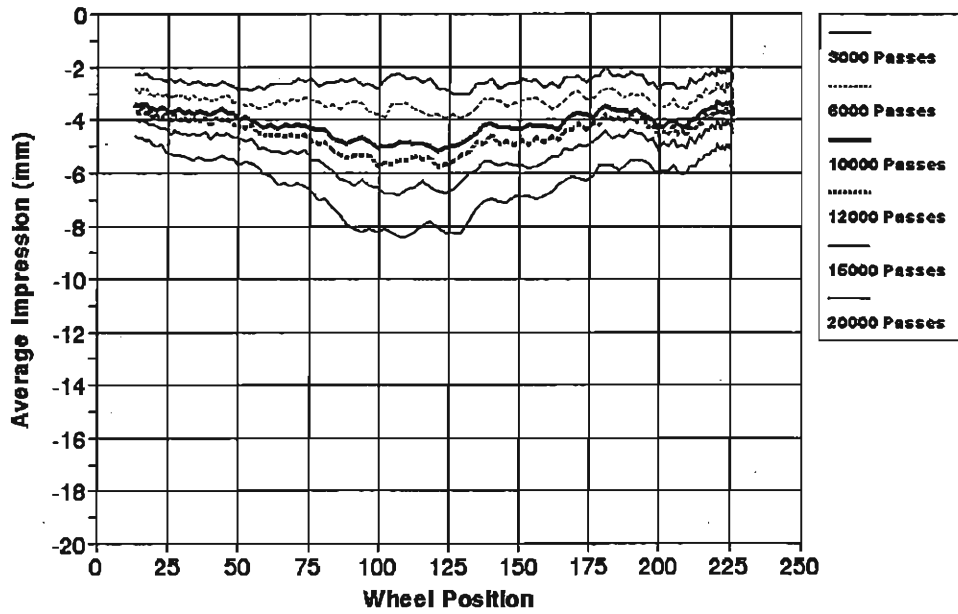

**SMA, FIBER**  
**Temperature = 55 C**

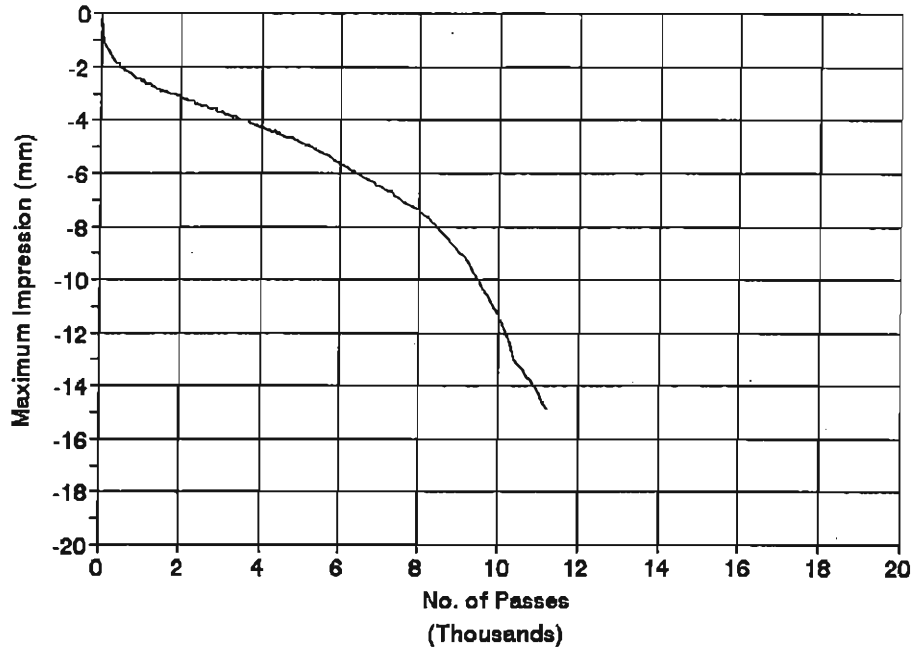

**Profiles**  
**Temperature = 55 C**

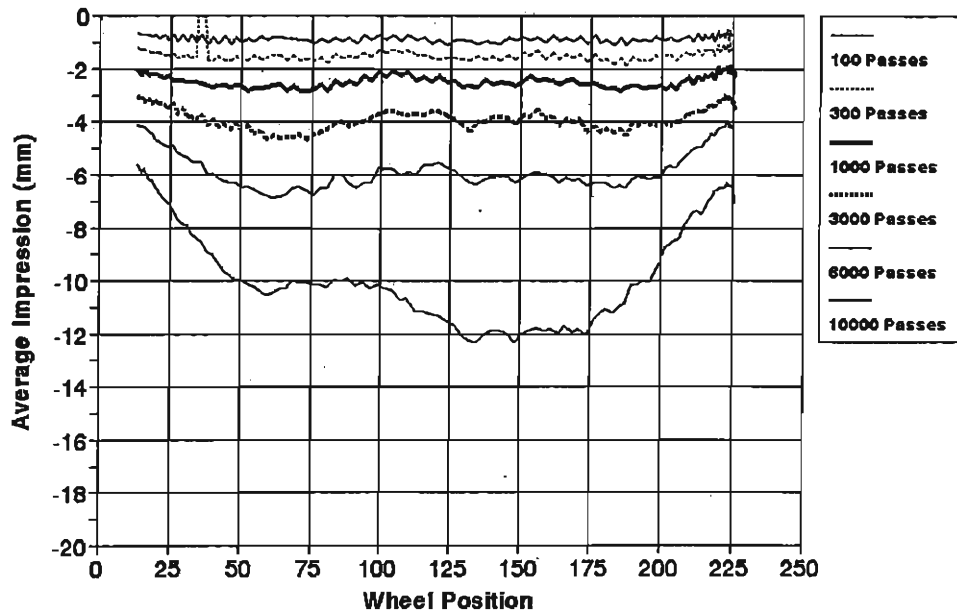

SMA, VESTOPLAST  
Temperature = 45 C

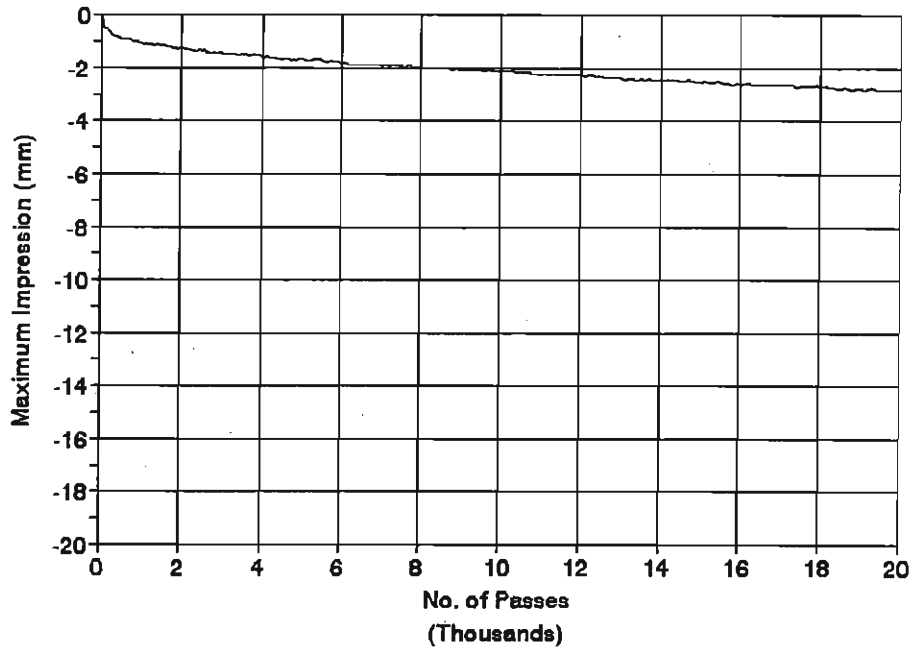

Profiles  
Temperature = 45 C

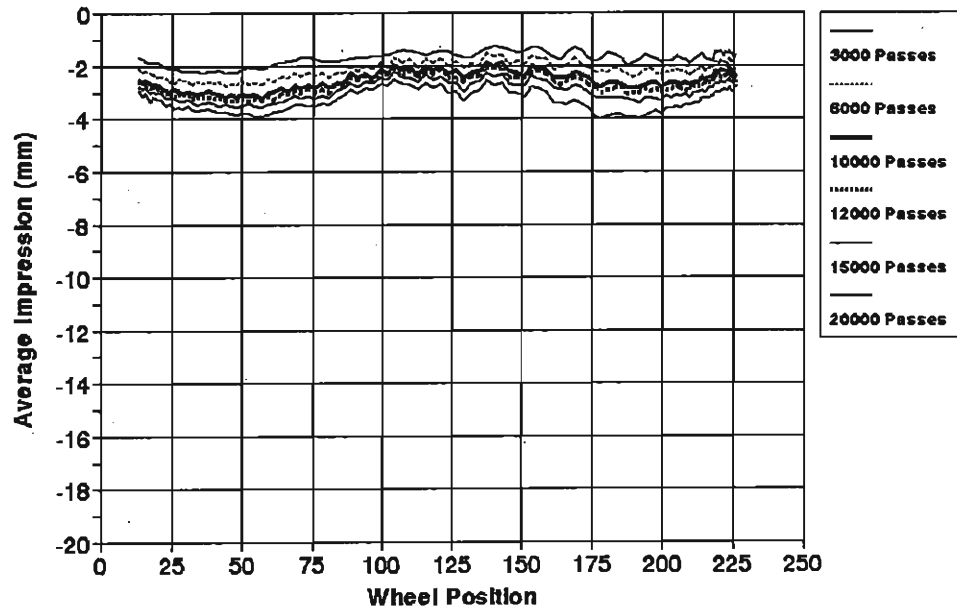

SMA, VESTOPLAST  
Temperature = 50 C

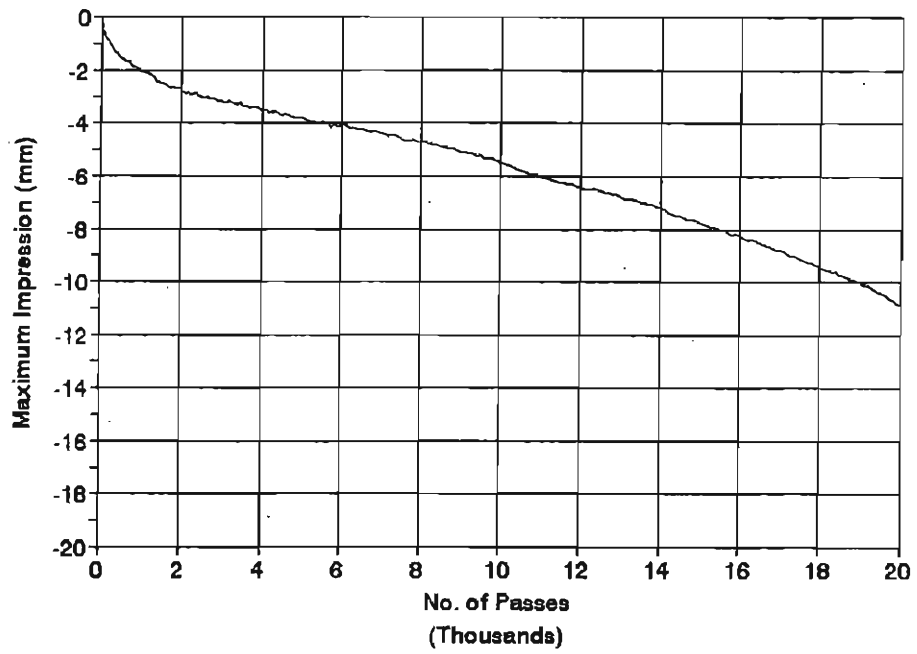

Profiles  
Temperature = 50 C

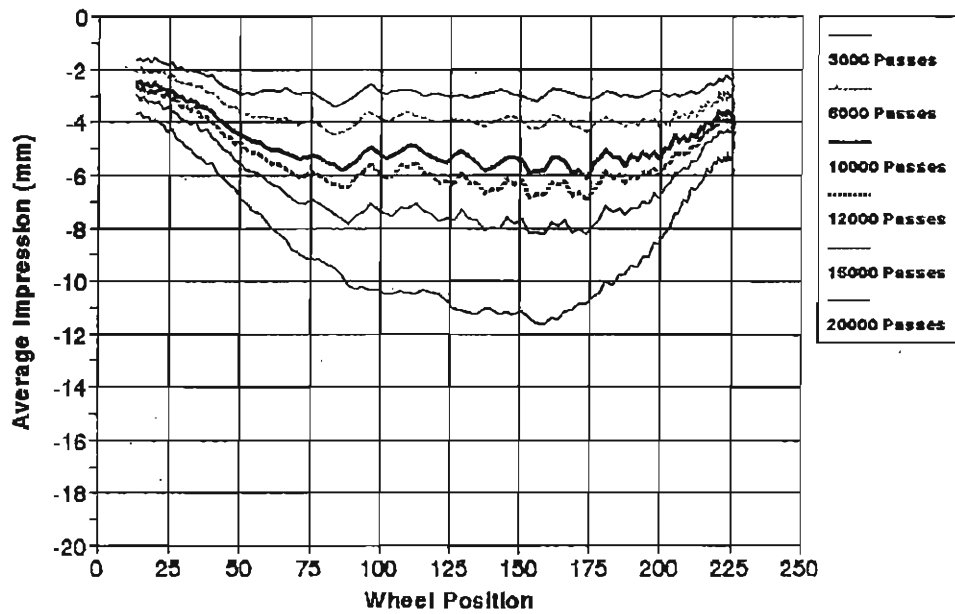

SMA, VESTOPLAST  
 Temperature = 55 C

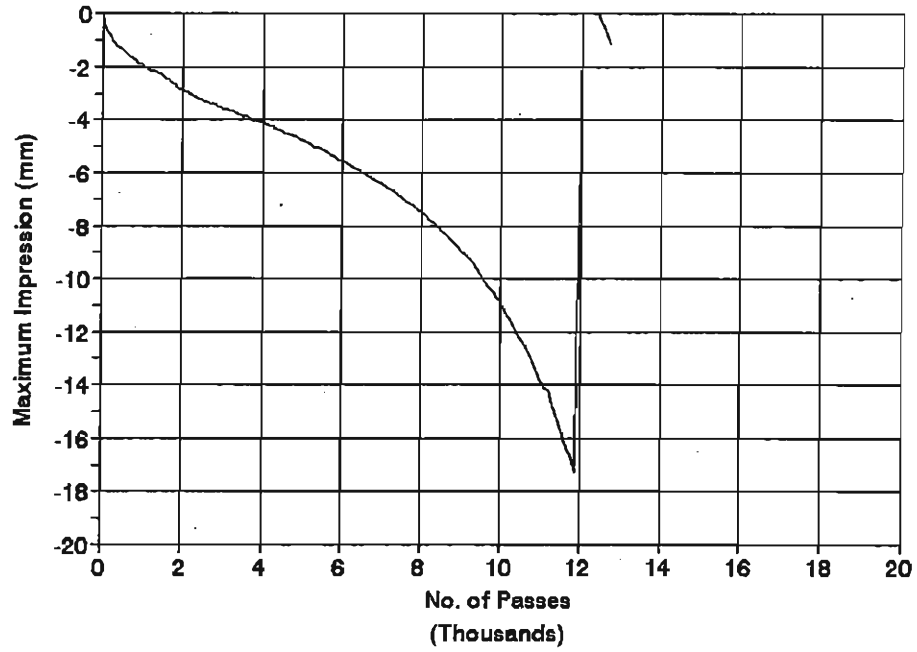

Profiles  
 Temperature = 55 C

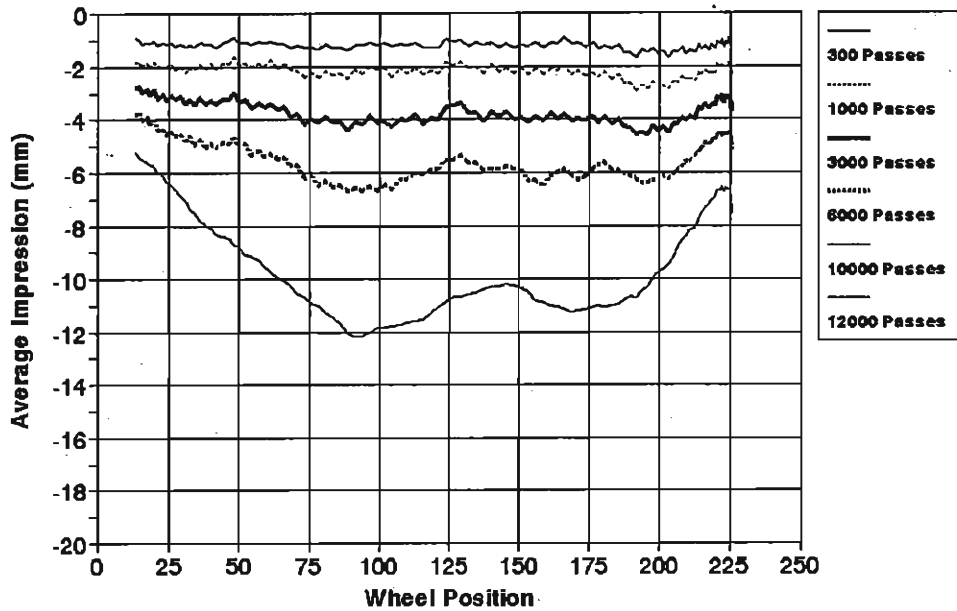



SMA, 1-D  
Temperature = 45 C

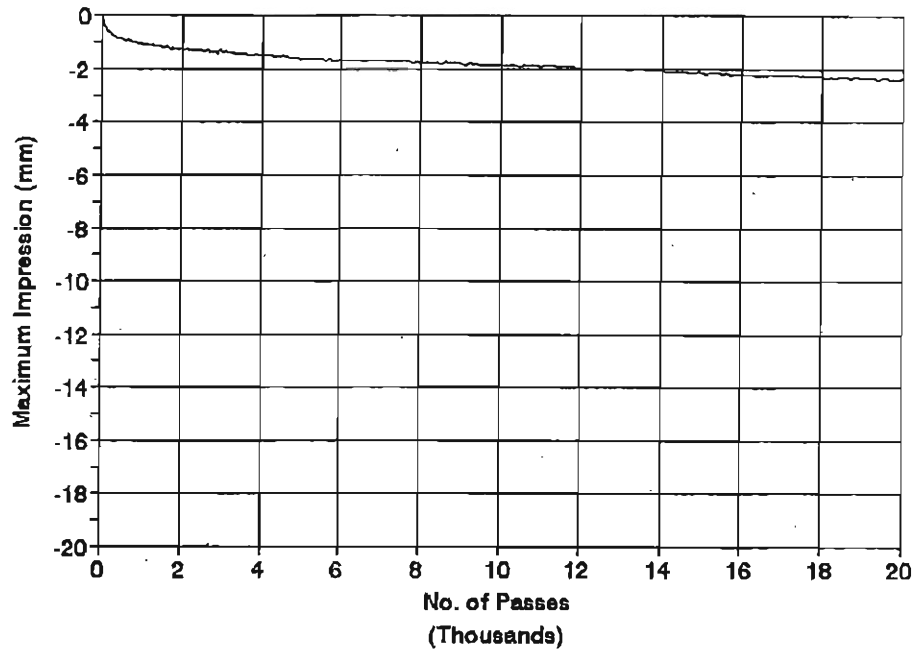

Profiles  
Temperature = 45 C

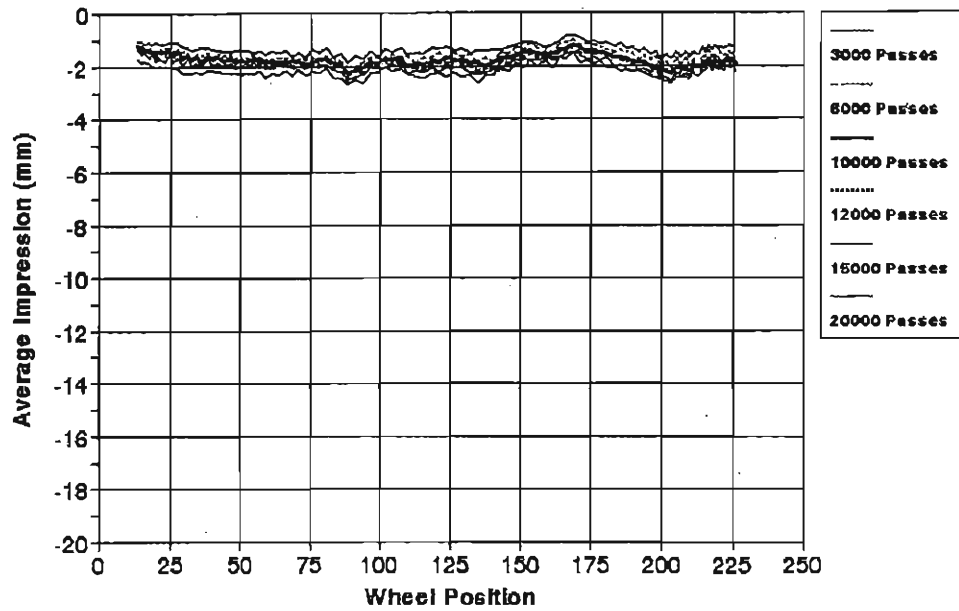

SMA, 1-D  
Temperature = 50 C

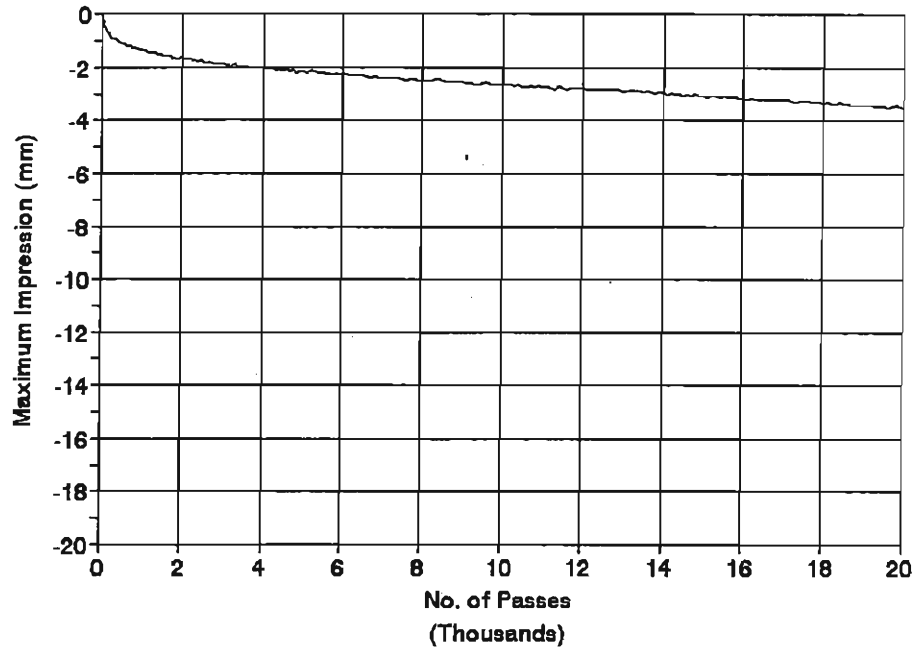

Profiles  
Temperature = 50 C

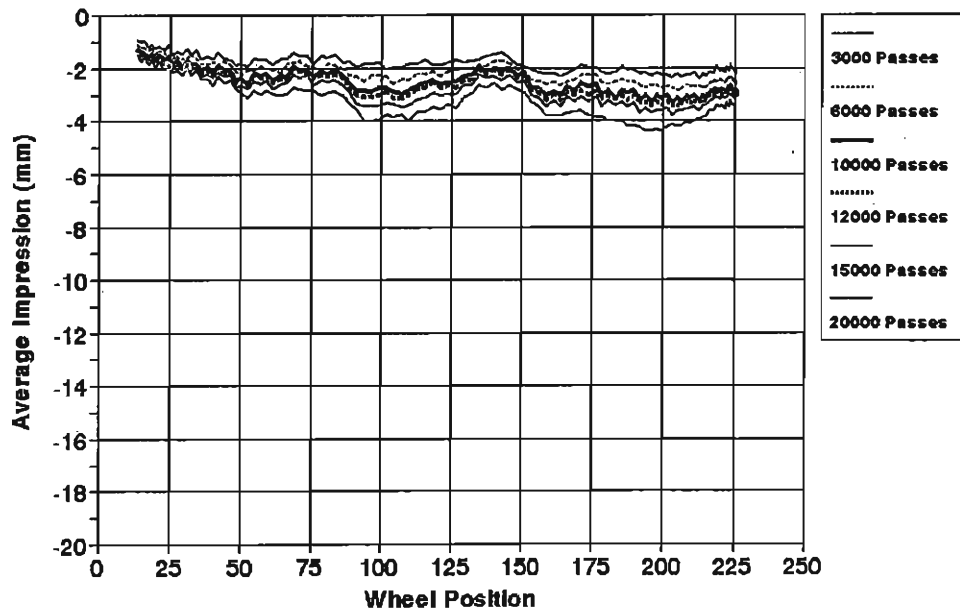

SMA, 1-D  
Temperature = 55 C

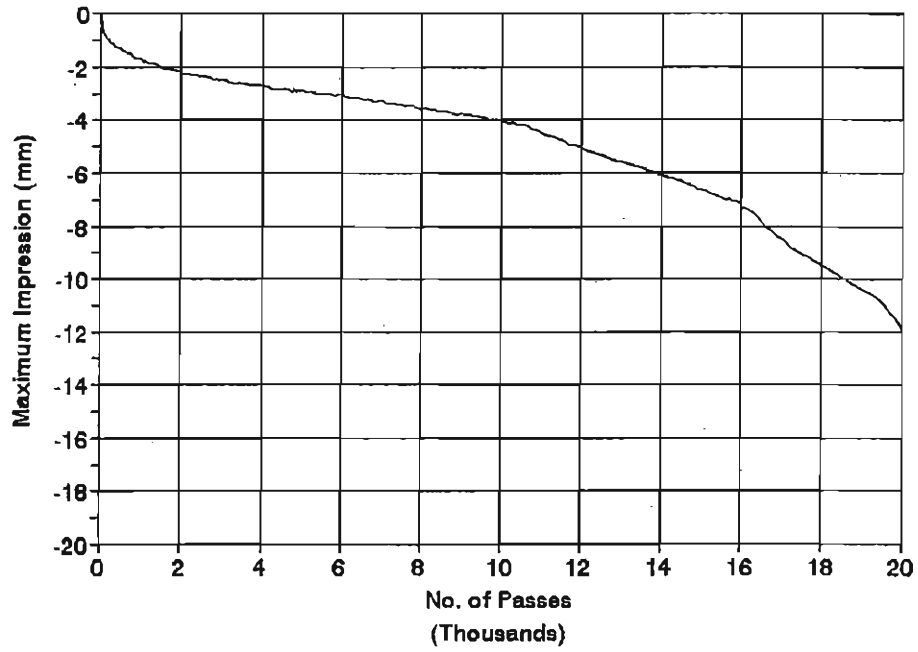

Profiles  
Temperature = 55 C

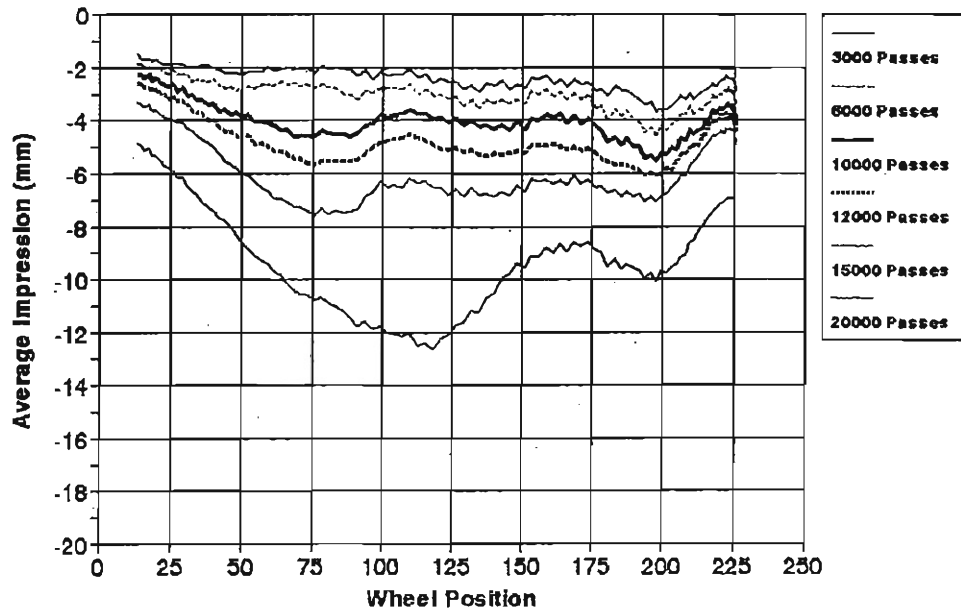

GRADING C  
Temperature = 45 C

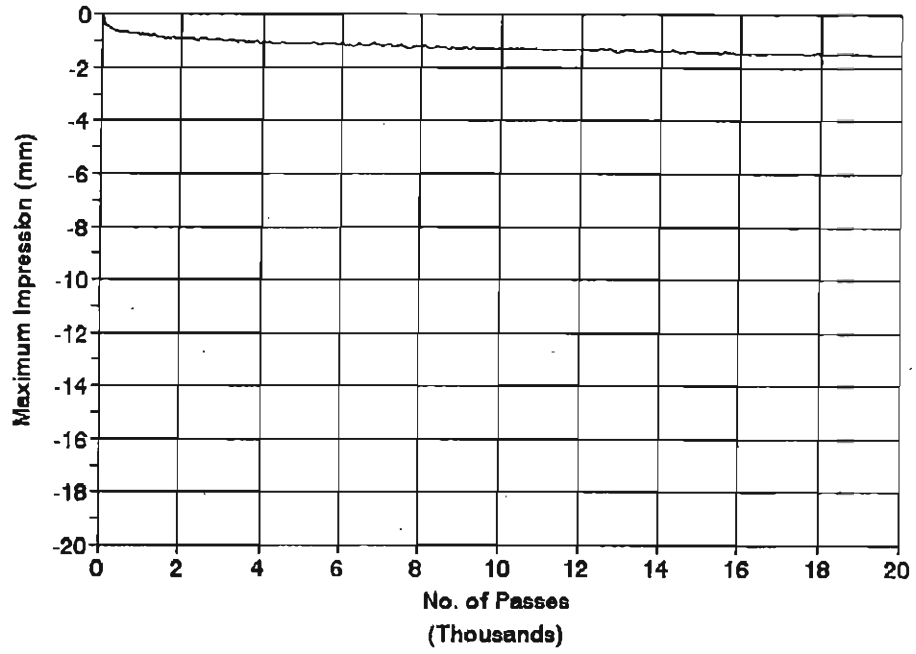

Profiles  
Temperature = 45 C

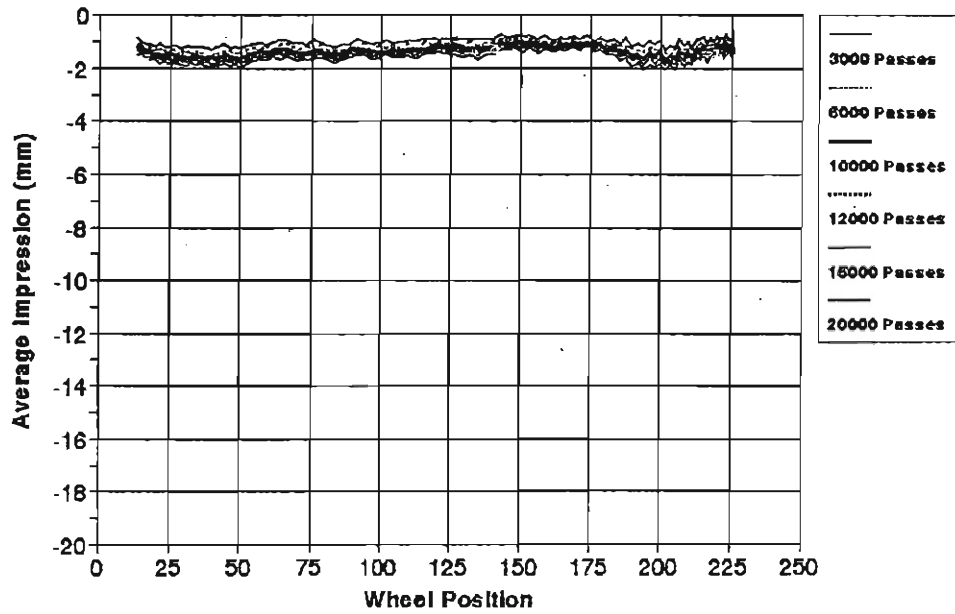

**GRADING C**  
Temperature = 50 C

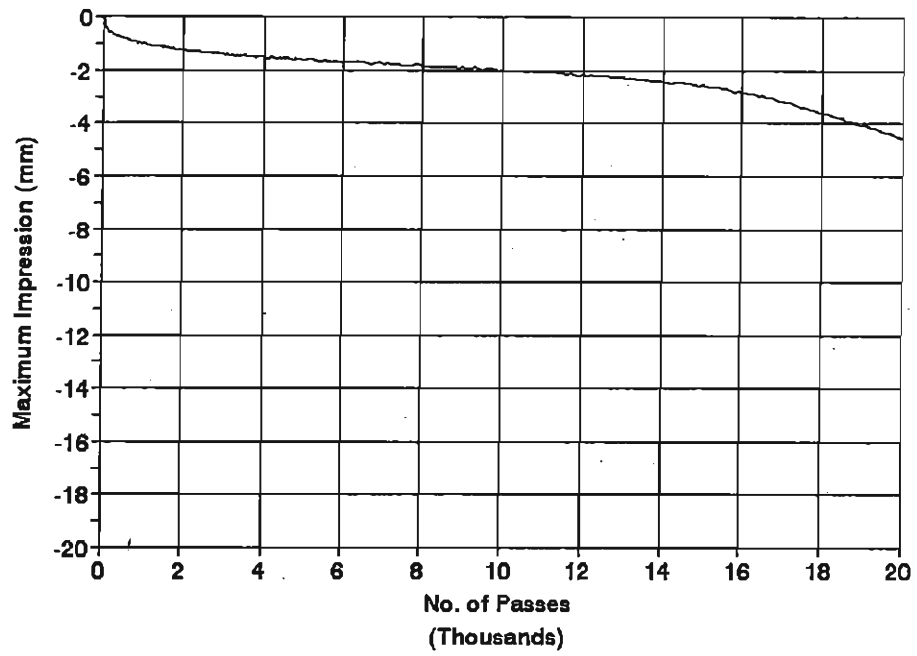

**Profiles**  
Temperature = 50 C

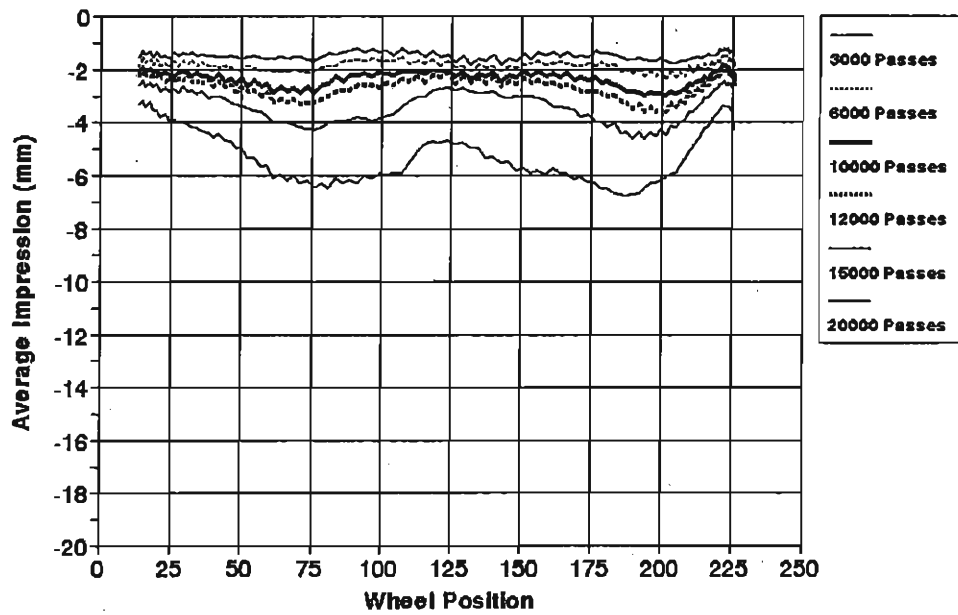

**GRADING C**  
Temperature = 55 C

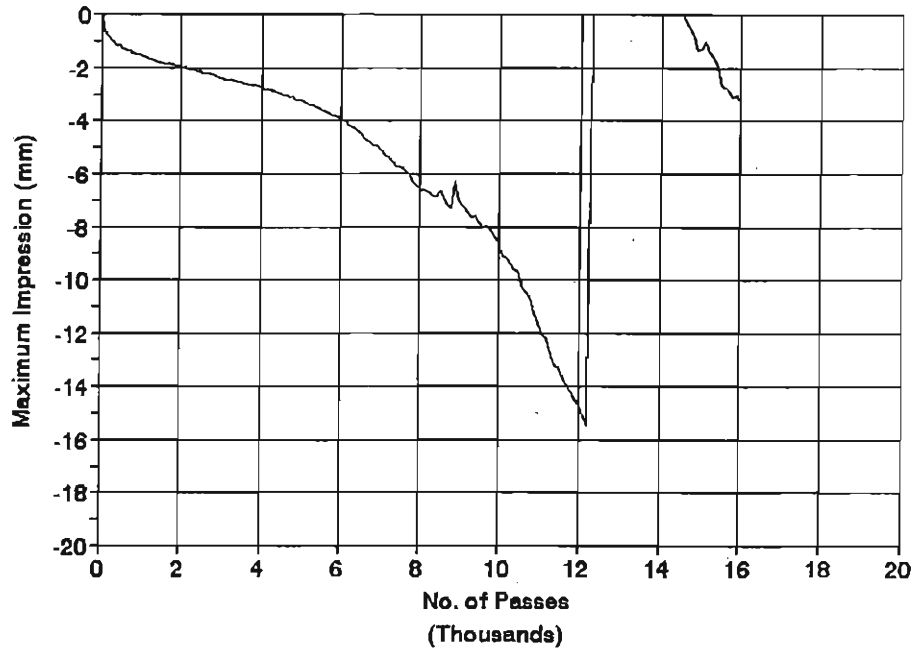

**Profiles**  
Temperature = 55 C

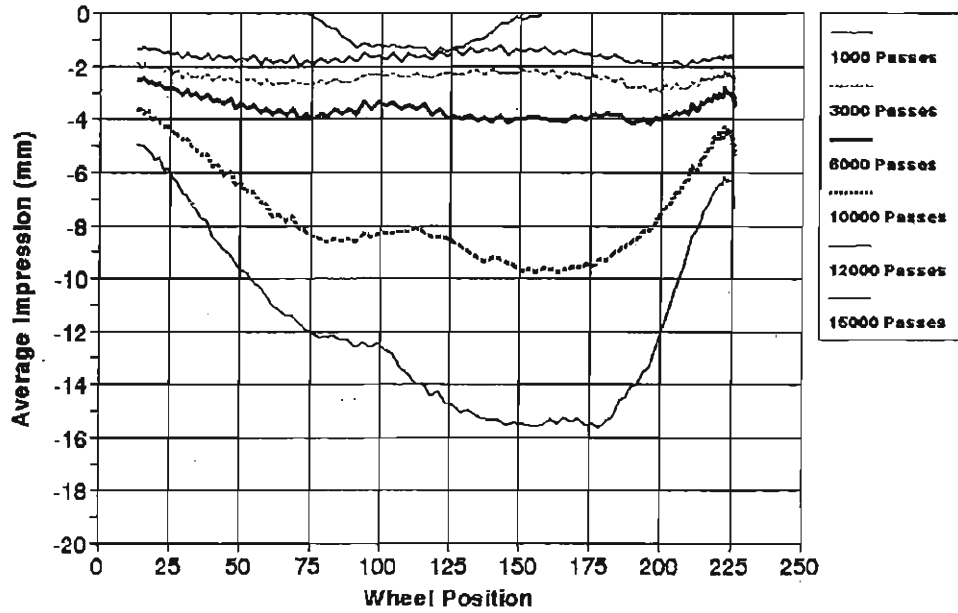

**Appendix D:  
French Rutting Tester Results.**

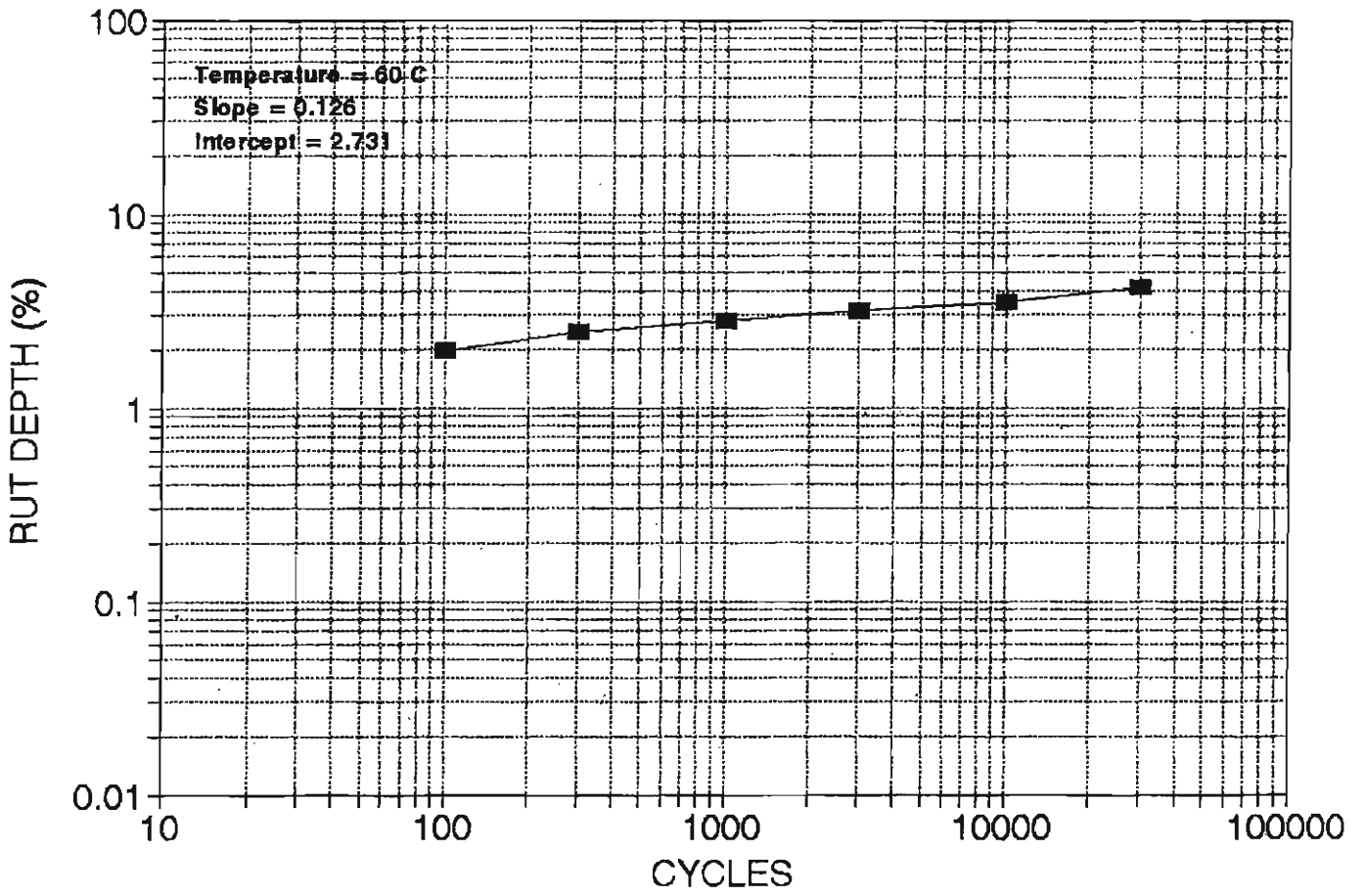

## SMA, FIBER



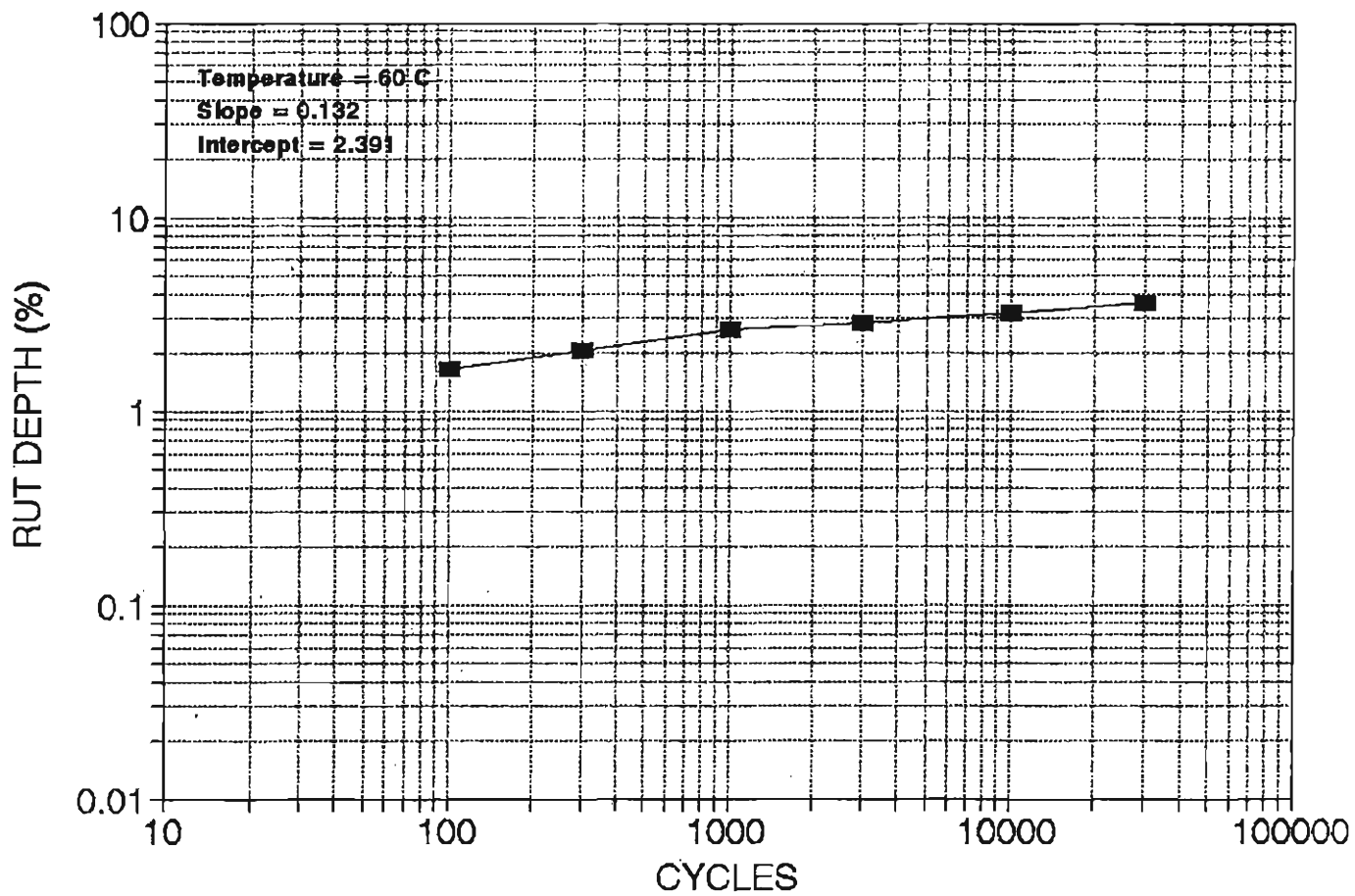

## SMA, VESTOPLAST

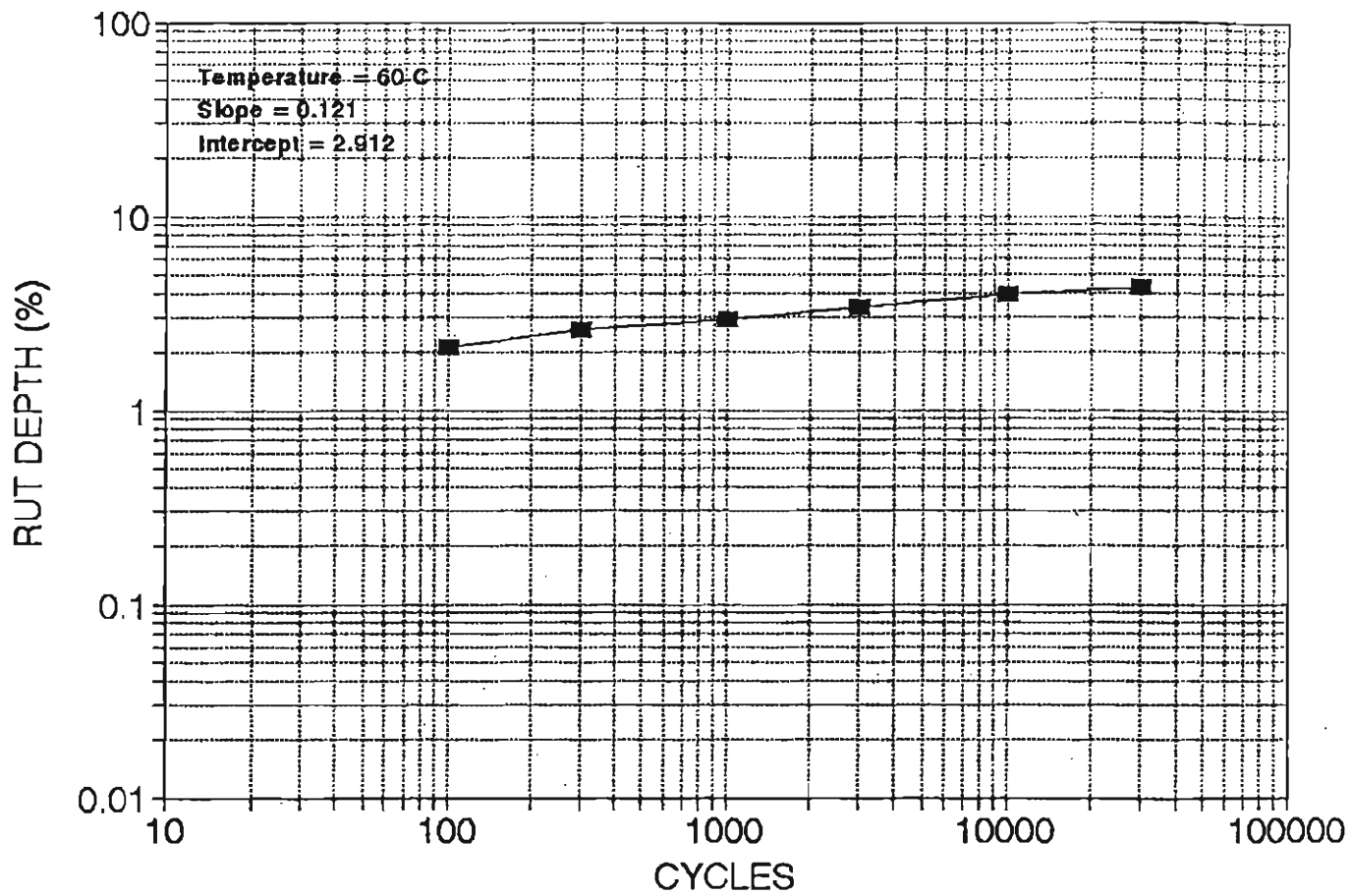

## SMA, POLYMER

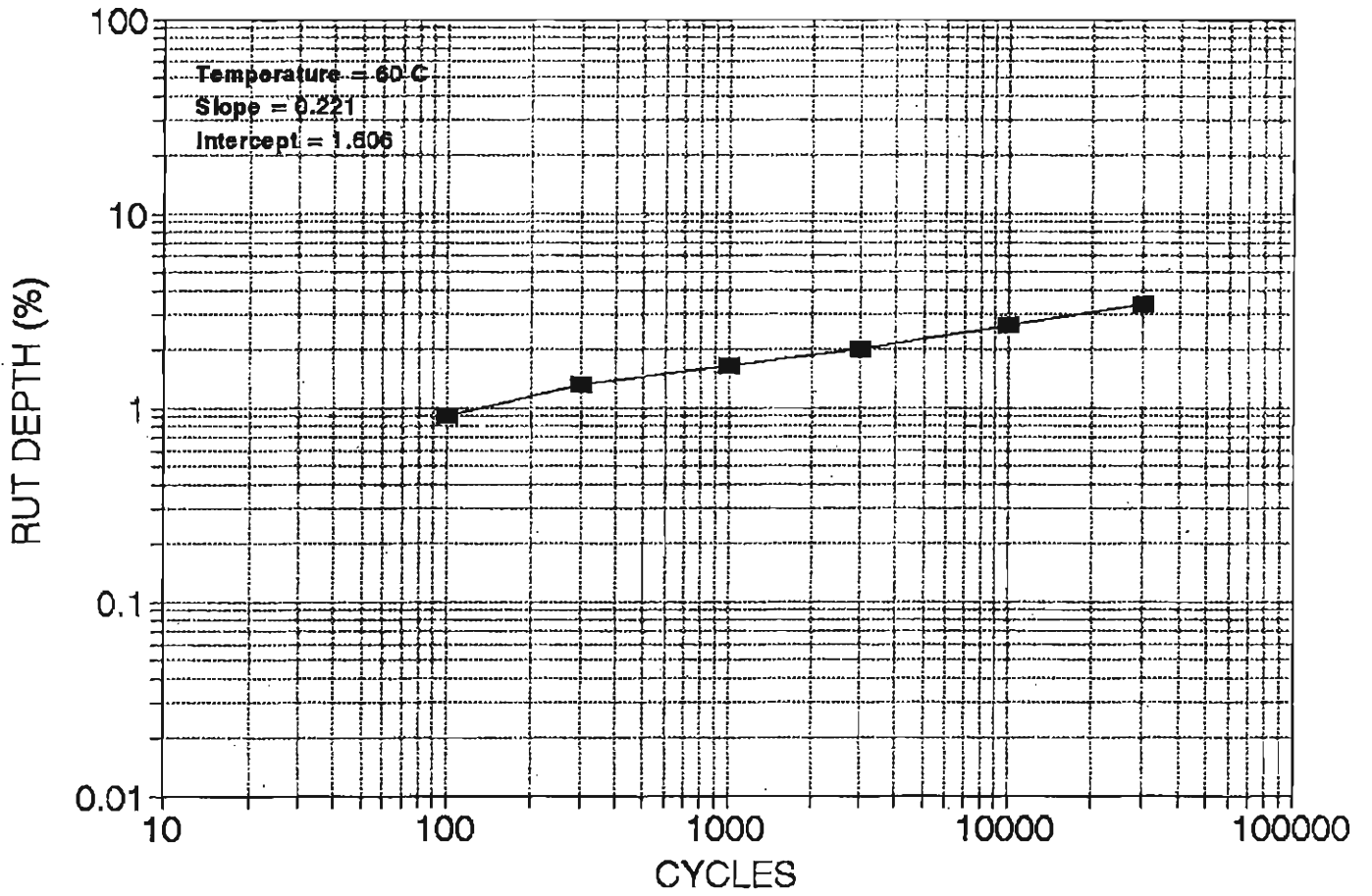

# GRADING C