

**Report No. CDOT-2008-7
Final Report**



MODIFICATION AND STATISTICAL ANALYSIS OF THE COLORADO ROCKFALL HAZARD RATING SYSTEM

**Christopher P. Russell, Dr. Paul Santi, Dr. Jerry D. Higgins
Colorado School of Mines**

September 2008

**COLORADO DEPARTMENT OF TRANSPORTATION
DTD APPLIED RESEARCH AND INNOVATION BRANCH**

The contents of this report reflect the views of the author(s), who is(are) responsible for the facts and accuracy of the data presented herein. The contents do not necessarily reflect the official views of the Colorado Department of Transportation or the Federal Highway Administration. This report does not constitute a standard, specification, or regulation.

1. Report No. CDOT-2008-7		2. Government Accession No.		3. Recipient's Catalog No.	
4. Title and Subtitle MODIFICATION AND STATISTICAL ANALYSIS OF THE COLORADO ROCKFALL HAZARD RATING SYSTEM				5. Report Date September 2008	
				6. Performing Organization Code	
7. Author(s) Christopher P. Russell, Dr. Paul Santi, Dr. Jerry D. Higgins				8. Performing Organization Report No. CDOT-2008-7	
9. Performing Organization Name and Address Colorado School of Mines Golden, Colorado 80401				10. Work Unit No. (TRAIS)	
				11. Contract or Grant No.	
12. Sponsoring Agency Name and Address Colorado Department of Transportation - Research 4201 E. Arkansas Ave. Denver, CO 80222				13. Type of Report and Period Covered	
				14. Sponsoring Agency Code	
15. Supplementary Notes Prepared in cooperation with the Colorado Department of Transportation, Materials and Geotechnical Branch, Rockfall Program					
16. Abstract The purpose of this study was to improve the current Rockfall Hazard Rating System (RHRS) in use by the Colorado Department of Transportation (CDOT) by adding several climatic and geological factors recognized in technical literature that contribute to rockfall. Once the system was improved, 200 slopes were rated within the Colorado Front Range: 106 crystalline cut slopes (a crystalline rock cut); 51 crystalline total slopes (both a cut and the natural slope above); 35 block-in-matrix slopes; and 8 sedimentary slopes. The resulting data for each slope type was analyzed using univariate least squares regression, multivariate ordinal logistic regression, and multivariate stepwise regression to identify and rank the dominating factors that contribute to rockfall. The rank of the new scores for the 200 slopes was compared to the rank of the original scores to ensure that the modifications allow for a better prediction of rockfall potential. There were not enough sedimentary slopes rated to accurately assess the factors that control rockfall for these slope types. However, the results from the least squares regression illustrated that several of the parameters added to the new RHRS could be used to predict the total hazard score for the remaining slope types. Analysis of these parameters using logistic regression resulted in the following parameters having the most influence on rockfall hazard for each slope type (ranked in order): for crystalline cut slopes – discontinuity aperture, ditch catchment, and rock character; for crystalline total slopes – launching features, block size/volume, discontinuity persistence and orientation; and for block-in-matrix slopes – block size, vegetation, and slope aspect. The stepwise regression produced equations in which the total hazard scores can be estimated by scoring the slope angle, launching features, overhang, and persistence and orientation for crystalline total slopes; and by scoring the slope aspect, block size, and vegetation for the block-in-matrix slopes. A succinct equation could not be produced for the crystalline cut slopes. Finally, comparison of the rank of the 200 slopes using both the modified and the original RHRS illustrated that there is no relationship between the two systems. In fact, the modified version allows for a larger spread of scores, and slopes that are characterized by a high rockfall potential are more easily identified.					
17. Keywords Rockfall Hazard Rating System (RHRS), cut slopes, total slopes, crystalline slopes, sedimentary slopes, block-in-matrix slopes, hazard rank, univariate least squares regression, multivariate ordinal logistic regression, multivariate stepwise regression			18. Distribution Statement No restrictions. This document is available to the public through the National Technical Information Service Springfield, VA 22161		
19. Security Classif. (of this report) Unclassified		20. Security Classif. (of this page) Unclassified		21. No. of Pages 137	22. Price

ABSTRACT

The purpose of this study was to improve their current Rockfall Hazard Rating System (RHRS) in use by the Colorado Department of Transportation (CDOT) by adding several climatic and geological factors recognized in technical literature that contribute to rockfall. Once the system was improved, 200 slopes were rated within the Colorado Front Range: 106 crystalline cut slopes (a crystalline rock cut); 51 crystalline total slopes (both a cut and the natural slope above); 35 block-in-matrix slopes; and 8 sedimentary slopes. The resulting data for each slope type was analyzed using univariate least squares regression, multivariate ordinal logistic regression, and multivariate stepwise regression to identify and rank the dominating factors that contribute to rockfall. The rank of the new scores for the 200 slopes was compared to the rank of the original scores to ensure that the modifications allow for a better prediction of rockfall potential.

There were not enough sedimentary slopes rated to accurately assess the factors that control rockfall for these slope types. However, the results from the least squares regression illustrated that several of the parameters added to the new RHRS could be used to predict the total hazard score for the remaining slope types. Analysis of these parameters using logistic regression resulted in the following parameters having the most influence on rockfall hazard for each slope type (ranked in order): for crystalline cut slopes - discontinuity aperture, ditch catchment, and rock character; for crystalline total slopes - launching features, block size / volume, discontinuity persistence and orientation; and for block-in-matrix slopes - block size, vegetation, and slope aspect. The stepwise regression produced equations in which the total hazard scores can be estimated by scoring the slope angle, launching features, overhang, and persistence and orientation for crystalline total slopes; and by scoring the slope aspect, block size, and vegetation for the block-in-matrix slopes. A succinct equation could not be produced for the crystalline cut slopes. Finally, comparison of the rank of the 200 slopes using both the modified and the

original RHRS illustrated that there is no relationship between the two systems. In fact, the modified version allows for a larger spread of scores, and slopes that are characterized by a high rockfall potential are more easily identified.

TABLE OF CONTENTS

ABSTRACT	iv
LIST OF FIGURES	x
LIST OF TABLES	xiv
ACKNOWLEDGEMENTS	xvi
CHAPTER 1 INTRODUCTION	1
1.1 Purpose.....	1
1.2 Background.....	2
1.3 Colorado’s RHRS	3
1.4 Ohio’s RHRS	5
1.5 Tennessee’s RHRS.....	8
1.6 New York’s RHRS	9
1.7 Washington’s Unstable Slope Management System	10
1.8 Idaho’s RHRS	10
1.9 Ontario Ministry of Transportation: RHRON.....	11
1.10 Missouri’s RHRS	12
1.11 Additional Rockfall Research.....	13
1.11.1 Freeze Thaw and Slope Aspect.....	13
1.11.2 Slope Angle.....	14
1.11.3 Ditch Catchment	15
1.11.4 Geological Conditions	17
1.11.5 Discontinuity Conditions	17
1.11.6 Block-in-Matrix Materials	18
CHAPTER 2 THE MODIFIED CRHRS: PARAMETERS AND PROCEDURES.....	19
2.1 Modifications	19
2.2 Slope Conditions.....	20
2.2.1 Slope Height.....	21
2.2.2 Rockfall Frequency	22
2.2.3 Average Slope Angle.....	23
2.2.4 Launching Features.....	24

2.2.5 Ditch Catchment	27
2.3 Climate Conditions	30
2.3.1 Annual Precipitation	31
2.3.2 Annual Freeze Thaw Cycles	32
2.3.3 Seepage / Water	33
2.3.4 Slope Aspect	34
2.4 Geological Conditions	35
2.4.1 Sedimentary Rock: Degree of Undercutting	36
2.4.2 Sedimentary Rock: Jar Slake	37
2.4.3 Sedimentary Rock: Degree of Interbedding	38
2.4.4 Crystalline Rock: Rock Character	40
2.4.5 Crystalline Rock: Degree of Overhang	43
2.4.6 Crystalline Rock: Weathering Grade	44
2.4.7 Discontinuities: Block Size / Volume	45
2.4.8 Discontinuities: Number of Sets	47
2.4.9 Discontinuities: Persistence and Orientation	48
2.4.10 Discontinuities: Aperture	48
2.4.11 Discontinuities: Weathering Condition	49
2.4.12 Discontinuities: Friction	51
2.4.13 Block-in-Matrix: Multiplier	51
2.4.14 Block-in-Matrix: Block Size	52
2.4.15 Block-in-Matrix: Block Shape	53
2.4.16 Block-in-Matrix: Vegetation	54
2.5 Traffic	55
2.5.1 Sight Distance	56
2.5.2 Average Vehicle Risk	58
2.5.3 Number of Accidents	59
2.6 Remarks	59
2.6.1 Major Rockslide Potential	59
2.6.2 Dominating Rockfall Mode	60
2.6.3 Dominating Sight Distance	62
2.6.4 Mitigation Effectiveness	63

CHAPTER 3 METHODOLOGY: DATA ANALYSIS	67
3.1 Initial Data Screening	67
3.2 Least Squares Regressions	69
3.3 Ordinal Logistic Regression	71
3.4 Multivariate Regression Analysis	75
3.5 Comparing the Two RHRS	75
CHAPTER 4 RESULTS	77
4.1 Least Squares Regressions	77
4.2 Ordinal Logistic Regression Results	82
4.2.1 Ordinal Logistic Regressions: Crystalline Cut Slopes	83
4.2.2 Ordinal Logistic Regressions: Crystalline Total Slopes	84
4.2.3 Ordinal Logistic Regressions: Block-in-Matrix Slopes	86
4.3 Summary of Results	87
4.4 Multivariate Regression	89
4.5 Comparison of the Two RHRS	92
CHAPTER 5 DISCUSSION	95
5.1 Logistic Regression Versus Least Squares Regression	95
5.2 Limitations due to Geographic Distribution	96
5.3 Limitations Due to Geological Homogeneity	98
5.4 Parameters Demonstrated to be Important	99
5.4.1 Crystalline Cut Slopes	100
5.4.2 Crystalline Total Slopes	101
5.4.3 Block-in-Matrix Slopes	102
5.5 Analysis	102
5.6 Comparison of the two RHRS	104
CHAPTER 6 CONCLUSIONS AND RECOMMENDATIONS	105
6.1 Conclusions	105
6.2 Recommendations	107
REFERENCES	109
APPENDIX A	114

LIST OF FIGURES

Figure 1.1: Consequence rating from rockfall as a function of slope angle	14
Figure 1.2: Ritchie (1963), ditch design criteria, illustrating suitable ditch width and depth for various slope angles and heights.	15
Figure 1.3: Suitable trapezoidal ditch shape illustrating 1 V: 1¼ H off-shoulder slope..	16
Figure 1.4: Suitable ditch design with shallow off-shoulder slope with Jersey barrier or rockfall fence..	16
Figure 2.1: Methodology to determine slope height.....	22
Figure 2.2: Consequence rating from rockfall as a function of slope angle and corresponding average slope angle scores.....	24
Figure 2.3: Examples of slopes with no launching features present.....	25
Figure 2.4: Examples of slopes with minor launching features present	26
Figure 2.5: Examples of slopes with many launching features present.....	26
Figure 2.6: Examples of slopes with major launching features present	27
Figure 2.7: Actual vs. required ditch dimensions and corresponding scores.....	29
Figure 2.8: Colorado’s average annual precipitation from 1961 to 1990	31
Figure 2.9: Colorado’s average annual freeze/thaw cycle distribution.....	33
Figure 2.10: Seepage on a cut slope face.	35
Figure 2.11: Degree of undercutting illustrated in sedimentary slope on CO Highway 24 in El Paso County.....	37
Figure 2.12: Various reactions to jar slake tests and corresponding ratings.....	39

Figure 2.13: Degree of interbedding illustrated in a sedimentary slope on I-70 in Summit County.....	40
Figure 2.14: Example of homogenous / massive crystalline rock on CO Highway 24 in El Paso County.....	41
Figure 2.15: Example of strong veins within crystalline rock on CO Highway 119 in Boulder County.....	42
Figure 2.16: Example of schist / shear zones < 6 inches within crystalline rock on I-70 in Clear Creek County.....	42
Figure 2.17: Example of weak pegmatites / micas / shear zones > 6 inches within crystalline rock on U.S. 6 in Jefferson County.....	43
Figure 2.18: Examples of differing degrees of overhang in crystalline rock.....	44
Figure 2.19: Examples of differing degrees of weathering grade within intact crystalline rock.....	45
Figure 2.20: Discontinuity block size / volume.....	46
Figure 2.21: Number of discontinuity sets.....	47
Figure 2.22: Discontinuity persistence and orientation.....	48
Figure 2.23: Discontinuity aperture.....	49
Figure 2.24: Discontinuity weathering.....	50
Figure 2.25: Discontinuity friction.....	52
Figure 2.26: Block-in-matrix block size.....	53
Figure 2.27: Block-in-matrix block shape.....	54
Figure 2.28: Block-in-matrix vegetation.....	55
Figure 2.29: Measuring sight distance on a blind corner from the edge of the roadway.....	57

Figure 2.30: Examples of conditions that could potentially lead to catastrophic rockslides onto Colorado highways	61
Figure 2.31: Examples of slopes with two material types present, block-in-matrix plus rock outcrops	62
Figure 2.32: Example of mitigation effectiveness graded as A	63
Figure 2.33: Example of mitigation effectiveness graded as B	64
Figure 2.34: Example of mitigation effectiveness graded as C	64
Figure 2.35: Example of mitigation effectiveness graded as D	65
Figure 2.36: Example of mitigation effectiveness graded as F	65
Figure 3.1: Bar chart showing the percent distribution of scores for the slope height hazard parameter for crystalline cut slopes.....	68
Figure 3.2: Bar chart showing the percent distribution of scores for the precipitation hazard parameter for crystalline cut slopes.....	69
Figure 3.3: Fitted line plot for freeze thaw vs. total hazard score for crystalline total slopes.....	70
Figure 3.4: Fitted line plot for slope height vs. total hazard score for crystalline cut slopes.....	70
Figure 4.1: Fitted line plot comparing the actual total hazard scores of crystalline cut slopes to the total hazard scores predicted from the eight significant logistic regression parameters.....	89
Figure 4.2: Fitted line plot comparing the actual total hazard scores of crystalline total slopes to the total hazard scores predicted from four significant logistic regression parameters.....	91
Figure 4.3: Fitted line plot comparing the actual total hazard scores of block-in-matrix slopes to the total hazard scores predicted from the three significant logistic regression parameters.....	92

Figure 4.4: Scatter plots illustrating the differences in scoring ranks between the old RHRS and the modified RHRS for the 200 slopes that were rated for this study 92

Figure 4.5: Histograms showing the distribution of total hazard scores for CDOT’s original RHRS vs. the modified RHRS 94

LIST OF TABLES

Table 1.1: Original Colorado RHRS scoring sheet.....	6
Table 1.2: Colorado’s current RHRS.....	7
Table 2.1: Modified Colorado RHRS.....	20
Table 2.2: Ditch shape effectiveness based on off shoulder slope angle.....	29
Table 2.3: Required decision sight distance based on posted speed limits.....	56
Table 3.1: Total hazard score divisions for each slope type.....	73
Table 4.1: Regression results for crystalline cut slopes comparing each parameter to rockfall frequency	77
Table 4.2: Regression results for crystalline cut slopes comparing each parameter to the total hazard score	78
Table 4.3: Regression results for crystalline total slopes comparing each parameter to rockfall frequency	78
Table 4.4: Regression results for crystalline total slopes comparing each parameter to the total hazard score	79
Table 4.5: Regression results for block-in-matrix slopes comparing each parameter to rockfall frequency	79
Table 4.6: Regression results for block-in-matrix slopes comparing each parameter to the total hazard score	80
Table 4.7: Regression results for sedimentary slopes comparing each parameter to rockfall frequency	80
Table 4.8: Regression results for sedimentary slopes comparing each parameter to the total hazard score	81

Table 4.9: Ordinal Logistic Regression for Crystalline Cut Slopes.....	83
Table 4.10: Ordinal Logistic Regression for Crystalline Total Slopes.....	85
Table 4.11: Ordinal Logistic Regression for Block-in-Matrix Slopes.....	86
Table 4.12: Rank of each parameter based on both least squares regression and logistic regression.....	88

ACKNOWLEDGEMENTS

I wish to express my sincere appreciation to the Colorado Department of Transportation for funding this project and making it possible, specifically Ty Ortiz and Erik Oerter with the Rockfall Program for their continual assistance. I also thank Dr. Paul Santi, my advisor, for not only guiding me through this project, but for also being a close friend and mentor during my 2 years here. In addition, I thank Dr. Keith Turner and Dr. Luis Tenorio for their support and assistance on the statistical analyses required for this project. I also thank Dr. Jerry Higgins both for his assistance on this project, and for providing me with an opportunity to gain valuable field experience in the field of geological engineering.

Finally, I wish to express my sincere gratitude for my wife, Sarah, who has supported me continuously through my education at the Colorado School of Mines, and has been there for me with encouragement and praise since the day I met her.

CHAPTER 1

INTRODUCTION

1.1 Purpose

Many miles of state highways are constructed in steep terrain where rockfall is common. In the past, state Departments of Transportation (DOTs) and their maintenance crews reacted to rockfall as it occurred by cleaning up the site and installing temporary mitigation structures. The development of Rockfall Hazard Rating Systems (RHRS) has enabled state DOTs to categorize their rock slopes according to the degree of hazard present. This allows them to prioritize the most hazardous slopes along the most traveled roadways that should receive mitigation as time and funds become available (Pierson & Van Vickle, 1993).

The purpose of this study was to build upon and improve the current RHRS in use by the Colorado Department of Transportation (CDOT) in order to more accurately assess the factors that contribute to rockfall. There are several weaknesses that needed to be addressed with CDOT's current RHRS. First, subjective terminology for several parameters does not allow for consistency when slopes are rated by different individuals. Second, there are several geological characteristics and climate conditions that are not addressed in their system that are known to contribute to rockfall. Third, their system does not separate hazard and risk elements. Finally, because there are only two parameters to describe the geological conditions of the slope, there is a possibility that a slope could be rated with a high total score even though the geological conditions are not likely to produce rockfall.

To address these issues, a thorough literature review was conducted on existing RHRS from several DOTs across the country. In addition, technical literature and research on rockfall and slope stability were reviewed to determine the most important factors that contribute to rock slope instability to include in the modified system. Recommendations have been made to incorporate more specific or descriptive rating criteria to remove the subjective nature from several of the categories in CDOT's current RHRS. There are also recommendations for additional components in order to include several geologic and climatic factors that are recognized widely in the literature to contribute to rockfall hazard and slope instability.

After completion, 200 rock slopes within the Front Range were rated using the modified RHRS. The resulting data was analyzed using univariate least squares regression and multivariate ordinal logistic regression in an attempt to identify and rank the dominating factors that contribute to rock slope instability within the Front Range of Colorado. Once these dominating factors were identified, a multivariate stepwise regression was used in an attempt to produce predictive equations using only a few parameters from the modified RHRS to allow for a simpler analysis of rockfall potential within the Colorado Front Range. Finally, the 200 slopes were ranked using the scores from the modified RHRS and compared to their rank using CDOT's original RHRS to ensure that the modifications allow for a better prediction of rockfall potential.

1.2 Background

Oregon developed the first state-wide RHRS based on a system published by Wyllie (1987). Wyllie introduced an exponential rating system that scored various categories that contribute to rockfall and their impact on traffic. This system was

modified by the Oregon DOT and used to rate over 3,000 sites in the state of Oregon. It categorizes rockfall potential and the hazard to traffic based on the following parameters: slope height, ditch catchment, average vehicle risk, decision site distance, roadway width, geologic character controlling rockfall, block size and quantity of rockfall, climate conditions and presence of water, and the rock fall history. All of the parameters are scored on an exponential system, with scores ranging from 3, 9, 27, and 81. The higher the score, the more likely the condition will promote rockfall or traffic disruption. Interpolation is allowed between the scoring ranges when judgment requires (Pierson, 1991; Pierson & Van Vickle, 1993).

The RHRS was adopted by 18 different states. Several states left the system as is, while others modified the system to suit their local conditions (Bateman, 2003). States that left the system unmodified include California, Kentucky, Nevada, Pennsylvania, Virginia (Witteman et al. 1992), Wyoming, North Carolina, Utah (Pack & Boie, 2002), and West Virginia (Szwilski, 2002). States that modified the system include Colorado (Stover, 1992), Arizona, New Jersey, Vermont (Eliassen & Ingraham, 2000), New York (NYDOT, 1996), Tennessee (Vandewater et al. 2005), Idaho (Miller, 2003), Ohio (Shakoor, 2005), and New Hampshire (Fish & Lane, 2001). Significant modifications are discussed below, as well as several other unique systems that were created by other state DOT's separate from the Oregon RHRS.

1.3 Colorado's RHRS

Colorado's current RHRS is a slight modification of the original Oregon DOT's RHRS (Stover, 1992; Andrew, 1994; CDOT, 1997; Pierson, 1991; Pierson & Van Vickle, 1993). In 1992, Bruce Stover with the Colorado Geological Survey prepared a system for CDOT to prioritize highway rockfall hazard state wide. The first stage was the development of the Colorado Rockfall Accidents on State Highways (CRASH) database

to identify areas of the highways that are most prone to rockfall. The Colorado Dept. of Highways (CDOH) accident database was used to identify and collect information on accidents attributed to “rocks on roadway.” This information was combined with data on road width, average daily traffic, and various other parameters from the Colorado Roadway Information System (CORIS) to develop CRASH (Stover, 1992).

CRASH enabled CDOT to match mileposts with accidents due to rockfall. In addition, CDOT conducted drive-throughs with maintenance personnel to identify stretches of highway where frequent rockfall was a problem. All of this information was combined to allow CDOT to identify the most rockfall prone stretches of highway within the state (Stover, 1992).

Finally, CDOT adopted and modified Oregon’s RHRS to perform detailed ratings of highway stretches within the state that had frequent rockfall (Stover, 1992). In 1994, the Colorado Rockfall Hazard Rating System was finalized and included the following parameters (Andrew, 1994) (Table 1.1):

- The slope profile factor takes into account slope height, segment length, slope inclination, and slope continuity (launching features).
- The geological factor considers two cases:
 1. Slopes where discontinuities and the overall structure of the rock mass are the dominant contributors to rockfall. This case considers the persistence, orientation, and friction along discontinuities within the rock slope.
 2. Slopes where differential erosion and undercutting are the dominant contributors to rockfall. This case considers the amount of differential erosion features, and the difference in erosion rates of the materials that make up the slope.

In addition, the block size or volume of material expected to fail is considered for either case.

- The “climate and presence of water on the slope” category rates the amount of precipitation, occurrence of freeze and thaw periods, and the duration that water is present on the slope.
- The rockfall history accounts for the frequency of rockfall occurrence at a particular slope based on drive-throughs with maintenance personnel.
- Finally, the number of traffic accidents attributed to rockfall within a particular mile marker is considered.

In 1997, CDOT modified the RHRS to include ditch catchment, decision site distance, and average daily traffic. An “Exposure” rating was also added to the climate category, however the exact meaning of this parameter is unknown, and it is not in use (Ortiz, 2006). Table 1.2 shows CDOT’s 1997 rockfall rating field worksheet. Another modification occurred in 2003, replacing average daily traffic with average vehicle risk.

1.4 Ohio’s RHRS

Ohio DOT also adopted Oregon’s RHRS, but modified it to suit their local geologic conditions. Ohio is characterized by flat lying sedimentary rock, and the dominant mode of rockfall is due to differential erosion of less resistant units and undercutting. Because of this, it was decided to perform slake durability tests on the weaker units to help predict rockfall potential in areas. It was also felt that Oregon’s ditch effectiveness rating could be improved; so it was decided to compare actual ditch dimensions to Ritchie’s recommended design, which uses slope height and angle to design ditches of a specific depth and width (Shakoor, 2005; Ritchie, 1963).

Table 1.1: Original Colorado RHRS Scoring Sheet (Andrew, 1994)

Rockfall Hazard Rating System						
FACTOR		RANK				
		3 Points	9 Points	27 Points	81 Points	
SLOPE PROFILE	Slope Height	25 to 50 ft	50 to 75 ft	75 to 100 ft	100 ft	
	Segment Length	0 to 250 ft	250 to 500 ft	500 to 750 ft	750 ft	
	Slope Inclination	15 to 25 degrees	25 to 35 degrees	35 to 50 degrees	50 degrees	
	Slope Continuity	Possible launching features	Some minor launching features	Many launching features	Major rock launching features	
	Average Block or Clast Size	6 to 12 in.	1 to 2 ft	2 to 5 ft	5 ft	
GEOLOGIC CHARACTERISTICS	Quantity of Rockfall Event	1 cu ft to 1 cu yd	1 to 3 cu yds	3 to 10 cu yds	10 cu yds	
	CASE 1	Structural Condition	Discontinuous fractures, favorable orientation	Discontinuous fractures, random orientation	Discontinuous fractures, adverse orientation	Continuous fractures, adverse orientation
		Rock Friction	Rough, irregular	Undulating smooth	Planar	Clay, gouge infilling, or slickensided
	CASE 2	Structural Condition	Few differential erosion features	Occasional erosion features	Many erosion features	Major erosion features
		Difference in Erosion	Small difference	Moderate difference	Large difference	Extreme difference
	Climate and Presence of Water on Slope		Low to moderate precipitation; no freezing periods; no water on slope	Moderate precipitation or short freezing periods, or intermittent water on slope	High precipitation or long freezing periods or continual water on slope	High Precipitation and long freezing periods, or continual water on slope and long freezing periods
Rockfall History (From Ride Through)		Few falls	Occasional falls	Many falls	Constant falls	
Number of Accidents Reported in Mile		0 to 5	5 to 10	10 to 15	15 and over	

Table 1.2: Colorado's Current RHRS (CDOT, 1997)

's 1997 Rockfall Rating Field Worksheet

struction and Materials Branch ~ 4340 East Louisiana Avenue, Denver, CO 80222

Information	SEGMENT ID NUMBER	ENGINEERING REGION	MAINTENANCE SECTION	DATE
	BEGIN MILE POST	END MILE POST	R/L OF CENTERLINE	RATER
Issues	Remarks			
Sight	Sight Distance			
Angle	Speed Limit			
Width	ADT			
Light	25 to 50 ft	50 to 75 ft	75 to 100 ft	>100 ft
Alignment	35° to 45°	45° to 55°	55° to 65°	>65°
Sign Features	Possible	Minor	Many	Major
Drainage	Good	Moderate	Limited	No
Volume/Quantity	<1 ft / <1 cy	1 to 2 ft / 1 to 3 cy	2 to 5 ft / 3 to 10 cy	>5 ft / >10 cy
Seepage / Exposure	Low / None / Favorable	Moderate / Some / Moderate	High / Moderate / Moderate	High / High / Adverse
Access/Orientation	Discontinuous / Favorable	Discontinuous / Random	Discontinuous / Adverse	Continuous / Adverse
Rock Friction	Rough, irregular	Undulating, smooth	Planar	Clay infilling, slickensided
Positional Features	Few differential	Occasional	Many	Major
Soil in Erosion	Small	Moderate	Large	Extreme
Surface	> 80 %	60 % - 80 %	40 % - 60 %	< 40 %
Yearly Traffic	< 1000	1000 - 5000	5000 - 15,000	> 15,000
Accidents	0 to 2	3 to 5	6 to 8	9 and over
Rockfall History	Few	Occasional	Many	Constant
	x 3 =	x 9 =	x 27 =	x 81 =

1.5 Tennessee's RHRS

Tennessee DOT also adopted the RHRS from Oregon, but made major modifications to the geologic character parameters. These parameters in Oregon's system did not accurately describe the various geologic factors that contribute to rockfall. Oregon's system groups all geologic conditions (discontinuity orientation, discontinuity infilling, effects of water, and rock friction) into one category for "Case 1 slopes: Structural condition." This rating was considered to be confusing because non-structural geologic factors are included within this category. In addition, differential erosion features are grouped into "Case 2 slopes: Structural condition" when this feature has nothing to do with the structural geology of the rock mass (Vandewater et al., 2005).

Tennessee authorities decided that additional geologic factors are required to adequately define the potential for rockfall. They also decided that various modes of rockfall within a given slope length (topple, wedge, planar, differential weathering, or ravelling) should be considered collectively rather than only rating the mode that presents the highest hazard. All of the modes consider the percent of occurrence of each within a particular slope segment and the block size expected. In addition, both planar and wedge rockfall modes are rated based on the steepness of the failure planes and micro and macro friction of the failure plane surfaces. The differential weathering rockfall mode also rates the degree of undercutting occurring. Finally, the ravelling rockfall mode also considers the block shape. In addition, Tennessee DOT only allowed interpolation between the 3, 9, 27, and 81 scores for parameters that could be directly measured (Vandewater et al., 2005).

1.6 New York's RHRS

New York also adopted Oregon's system, but modified it to give a probable risk for each slope. Three main factors were considered for analysis, Geologic Factors (GF), Section Factors (SF), and Human Exposure Factors (HEF). These factors were collectively multiplied to establish the Total Relative Risk (TRR) for each slope (NYDOT, 1996).

The Geologic Factor considers two types of slope separately: crystalline and sedimentary. Crystalline slopes are rated based on continuity, number, and direction of dip of the discontinuities. Sedimentary slopes are rated based on the dip of bedding planes and other discontinuities, and the degree of undercutting present if differential erosion takes place (NYDOT, 1996). The Geologic Factors also include the block size likely to fall, the friction along discontinuities, the presence of water or ice, rockfall frequency, and the back-slope conditions above the road cut (NYDOT, 1996).

The Section Factor considers the likelihood of whether fallen rocks will reach the roadway. This parameter is obtained by direct comparison to Ritchie ditch design criteria (NYDOT, 1996; Ritchie, 1963; NYDOT, 2003).

The Human Exposure Factor is used to judge the likelihood of a traffic accident in the event that a rockfall does occur. This rating is based on the slope length, decision site distance, number of lanes, the average daily traffic, speed limit, and stopping distance available (NYDOT, 1996).

In addition, New York authorities assigned a Risk Reduction (RR) to a slope if mitigation measures were employed. Various types of mitigation are assigned various RR values. Once a method is employed to a slope, the TRR is reduced by this RR value resulting in a residual risk value: $\text{residual risk} = \text{TRR} - \text{RR}$. This Risk Reduction method allows the DOT to establish cost: benefits for various mitigation techniques to a slope (NYDOT, 1996; Hadjin, 2002).

1.7 Washington's Unstable Slope Management System

The state of Washington developed a system of their own to prioritize their hazardous slopes. Rockfall, landslide, and debris flows are grouped together and rated collectively with only one rating category based on the severity of a possible event. Geological and geotechnical factors that influence slope stability are not addressed in their system. Rather, mostly economic factors define the rating system. These parameters include the average daily traffic, decision site distance, the length and width of roadway likely to be impacted given a rockfall or landslide, the average vehicle risk, pavement damage, failure frequency, maintenance costs, number of accidents in the last 10 years, and the availability of detours (Lowell & Morin, 2000).

Washington DOT also does not address the highest rated slopes first. Rather, they categorize their slopes on the basis of the highway functional class. Major interstates and state highways receive priority for mitigation rather than a slope with a higher hazard, but has a lower risk because it is present on a less traveled road (Lowell & Morin, 2000).

Washington also came up with a useful cost / benefit ratio program to use to determine if mitigation structures are economical. The cost of routine maintenance on a slope over 20 years, plus the economic loss expected from a major failure due to traffic delays and repair costs are compared with the actual cost of an adequate mitigation program. If this cost exceeds the cost of the mitigation, efforts are taken to repair the slope (Lowell & Morin, 2000).

1.8 Idaho's RHRS

The Idaho Transportation Dept. uses a system that combines Washington State's Unstable Slope Management System with Oregon's RHRS, called HiSIMS (Highway

Slope Instability Management System). This system considers the following parameters: road width, frequency of ditch clean out, vegetation on the slope, failure frequency, the length of roadway affected, maintenance required, availability of detours to avoid traffic delays, average daily traffic, decision site distance, and one category to rate the potential for an extreme rockfall, landslide, or debris flow event (Miller, 2003).

1.9 Ontario Ministry of Transportation: RHRON

Ontario also adopted Oregon's system, but modified it immensely to include much more detail in their analysis to suit their local conditions. The original RHRS was not practical to rate Ontario's small rock cuts, where freeze thaw is the dominant driver and ravelling is the dominant mode of rockfall. Ontario divided RHRON (Rockfall Hazard Rating System for Ontario) into 4 main categories (Senior, 1999):

- Magnitude:** Describes the volume of material expected from a rockfall. This parameter rates volume of loose rock on the slope, the typical volume per rockfall, and the height of unstable rock.
- Instability:** Describes the stability of the slope based on the type of failure to occur, such as ravelling, wedge or planar failures, or undercutting. These parameters are rated based on the slope face looseness and irregularity, water table height, block size, the rock's unconfined compressive strength, slake durability index, and discontinuity spacing, orientation, persistence, and shear strength.
- Reach:** Describes the likelihood of rockfall reaching the roadway. This parameter is rated based on the presence of launching features, the likely amount of

ditch overspill, the percent of pavement likely to be blocked in a given rockfall, and a comparison of slope height to the ditch and shoulder width.

Consequence: Describes the risk to traffic given a rockfall. This parameter is based on the average daily traffic, slope length, road width (space for vehicles to maneuver), and decision site distance.

1.10 Missouri's RHRS

Missouri DOT decided to separate their RHRS into risk and consequence factors. Each parameter is placed into one of the categories (or both for some instances), and rated according to its potential probability to produce rockfall, or to the consequence it has for public endangerment. The following parameters are considered in Missouri's RHRS: rock cut height, slope angle, rock face instability (frequency of rockfall), differential erosion features, intact rock strength (estimated from blows with a geologic hammer), slope face irregularity, face looseness, block size, presence of water, ditch width, ditch volume, ditch shape, shoulder width, number of lanes, rockfall volume, average daily traffic, average vehicle risk, and decision site distance. They also have an adjustment factor for karst areas, adversely oriented discontinuities, and "bad benches" on a rock slope (Maerz, et al., 2005).

Missouri measured many of the parameters by using a scaled digital recording device to save time and money. Several of the parameters used by Missouri are unique to their rock cut conditions, such as the karst effect and the bench effect. The ditch effectiveness also considers whether the rocks are likely to roll, fall, or bounce from the slope based on slope angles and launching features due to "bad benches." CRSP was used to simulate these behaviors and determine adequate ditch dimensions using Ritchie design criteria (described below) (Maerz, et al., 2005).

1.11 Additional Rockfall Research

Review of technical literature revealed that there are other factors that contribute to rockfall potential, some of which are not included in several state DOT's rockfall hazard rating systems. These factors include freeze thaw cycles and slope aspect, new methods for slope angle rating, new methods for ditch catchment rating, additional geologic conditions, and additional discontinuity conditions. These factors are discussed in detail below, and are included in the modified CRHRS described in Chapter 2.

1.11.1 Freeze Thaw and Slope Aspect

Many authors argue that precipitation and frost wedging (ice jacking) are the most important climatic factors that contribute to rockfall (Flatland, 1993; Nichol & Watters, 1983; Romana, 1988; Moore, 1986; Eliassen & Ingraham, 2000; Senior, 1999). In Colorado, precipitation and snowfall with associated freeze-thaw was considered to be the most significant factor of rockfall along the Georgetown incline (Arndt et al., 2003). It is also recognized that the slope aspect will dramatically affect the climatic conditions a rock slope experiences throughout a year (Flatland, 1993; Mazzoccola & Hudson, 1996; Watters, 1998). South facing slopes will experience more temperature variation annually than north facing slopes, and this allows ice to melt deeper into the rock mass, generating greater degrees of instability (Mazzoccola & Hudson, 1996; Barrett & White, 1991).

1.11.2 Slope Angle

The importance of slope angle variations were studied for Missouri DOT's RHRS based on research by Maerz et al. (2005), using the Colorado Rockfall Simulation Program (CRSP). Slope angle was used to determine the consequence of whether a rock is more likely to bounce onto the roadway, fall directly into a ditch, or roll down the slope with enough energy to reach the road. It was found that large rocks rolling down slopes around 30° are most likely to reach the roadway, and small rocks that detach from near vertical cuts (around 85°) are likely to bounce off of the cut face and end up in the road way (Figure 1.1). Rocks falling from slopes less than 30° do not gain enough momentum to even reach the roadway, and rocks originating from vertical cuts fall directly into the catchment ditch. The consequence rating increases as the slope angle decreases from 70° to 30° because larger rocks are more likely to roll and pick up enough horizontal momentum to reach the road.

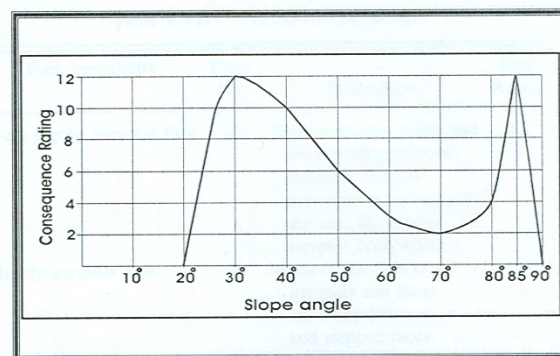

Figure 1.1: Consequence rating from rockfall as a function of slope angle (taken from Maerz et al., 2005).

1.11.3 Ditch Catchment

In 1963, Ritchie with the Washington State DOT proposed ditch design criteria based on slope heights and angles by performing rock rolling experiments (Figure 1.2). Several DOT's and authors recommend comparing actual ditch dimensions to Ritchie Ditch Design in order to rate the catchment effectiveness (Maerz et al., 2005; Hadjin, 2002; Budetta, 2004). In addition to appropriate ditch depth and width, the ditch shape is also a factor that contributes to effective rockfall catchment (Ritchie, 1963; Badger & Lowell, 1992; Maerz et al. 2005). Even if a ditch has suitable depth and width, if the off-shoulder slope of the ditch is designed too shallow, it simply provides a ramp for falling rocks to roll onto the road way (Ritchie, 1963). Some researchers suggest that the ditch design should be trapezoidal shaped, with a 1 V: 1¼ H off shoulder slope in order to prevent rocks from rolling up onto the road (Figure 1.3) (Ritchie, 1963; Badger & Lowell, 1992; NYDOT, 2003).

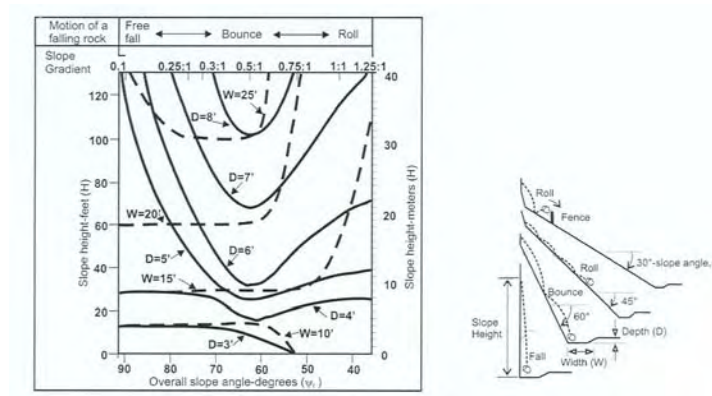

Figure 1.2: Ritchie (1963), ditch design criteria, illustrating suitable ditch width and depth for various slope angles and heights.

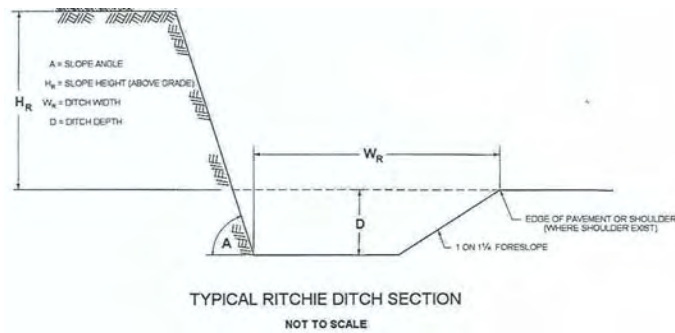

Figure 1.3: Suitable trapezoidal ditch shape illustrating 1 V: 1¼ H off-shoulder slope. Figure obtained from NYDOT (2003).

NYDOT (2003) mentions that the steep off-shoulder slope and trapezoidal ditch shape is difficult to construct and maintain; therefore this design may not always be feasible or possible. An off-shoulder slope can be as shallow as 1 V: 6 H if a Jersey barrier or rockfall fence is installed at the edge of the pavement or shoulder (Figure 1.4) (Badger & Lowell, 1992).

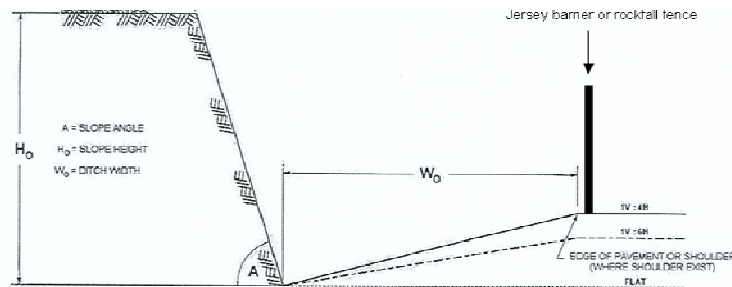

Figure 1.4: Suitable ditch design with shallow off-shoulder slope with Jersey barrier or rockfall fence. Figure modified from NYDOT (2003).

1.11.4 Geological Conditions

Researchers have suggested that geological conditions are what contribute the most to rockfall potential (Flatland, 1993; Szwiliski, 2002), and these conditions need to be examined in much more detail (Vandewater et al., 2005). It is also argued that because the geological factors contribute so strongly to the actual rockfall potential, they should be weighted more than the other parameters that do not contribute as significantly (Flatland, 1993, Vandewater et al., 2005).

Vandewater et al. (2005) argues that the degree of lithological variation (strong and weak interbeds) largely controls stability in sedimentary slopes. Shakoor (2005) expands on this characteristic by illustrating that the slake durability of the weak interbeds has the greatest influence on the differential erosion rates and subsequent undercutting and resulting rockfall.

1.11.5 Discontinuity Conditions

The stability of a rock mass can be more accurately assessed given more useful information on the character and condition of discontinuities within a rock slope (Bienawski, 1989; Barton, et al., 1974). The following characteristics of discontinuities largely control stability within a rockmass:

- The number and spacing of discontinuity sets (Vandewater et al., 2005; Senior, 1999; Maerz et al., 2005; Romana, 1988; Nichol & Watters, 1983; Mazzoccola & Hudson, 1996).
- Aperture (Senior, 1999; Maerz et al., 2005; Romana, 1989; Mazzoccola & Hudson, 1996).

- Physical and chemical weathering (Flatland, 1993; Maerz et al., 2005; Eliassen & Ingraham, 2000; Barrett & White, 1991; Ritchie, 1963).
- Cohesion and friction along discontinuity surfaces (Piteau, 1970; Flatland, 1993; Mazzoccola & Hudson, 1996).

These conditions are not examined in enough detail with current RHRS in use across the country. Most of the adaptations from the Oregon RHRS only consider the friction and orientation of discontinuities within a rock mass, and do not address these other characteristics that contribute to both rockfall and rock slope instability.

1.11.6 Block-in-Matrix Materials

Several authors recommend including rockfall assessment for block-in-matrix materials (glacial deposits, debris flow deposits, colluvium etc.), as these materials often contribute to excessive rockfall reaching roadways (Vandewater et al., 2005; Maerz et al., 2005; Miller, 2003). Rockfall in these types of materials are the result of erosion of the matrix soil, and successive ravelling of the larger blocks as they lose their surrounding support.

CHAPTER 2

THE MODIFIED CRHRS: PARAMETERS AND PROCEDURES

2.1 Modifications

Review of CDOT's current RHRS in Tables 1.1 and 1.2 reveals that many of the parameters are scored based on subjective terminology such as "possible, minor, many; low, moderate, high; few, occasional, many" etc. Several of the modifications to the system involved removing terminology of this nature, and replacing the scoring parameters with either numerical values or more descriptive terminology based on research conducted during the literature review. These categories include launching features, ditch catchment, precipitation/ seepage/ exposure, fractures/ orientation, erosional features, difference in erosion, and observed history. In addition, CDOT's current RHRS does not rate several factors that are widely recognized in the recent literature to contribute towards rock slope instability. Therefore, several categories have been changed, expanded upon, or added based on research information.

The modified system contains four separate categories that contribute to rockfall hazard: slope character, climatic conditions, geologic conditions, and discontinuity conditions. There is a category that is scored separately for risk, and is composed of traffic conditions. All of the parameters are summarized in the new Colorado Rockfall Hazard Rating System in Table 2.1, and are described in detail below. A total of 200 slopes within the Colorado Front Range were selected by CDOT and rated using the field worksheet from Table 2.1.

Table 2.1: The modified Colorado RHRS

Colorado Rockfall Hazard Rating Field Worksheet						
Sight Information		SEQUENT D NUMBER	ENGINEERING REGION	MAINTENANCE SECTION	DATE	
ROUTE NO	ROUTE NO	BEGIN/END POST	END MILE POST	R/L OF CENTERLINE	RATER	
Actual Values		Remarks				
Slope Height	Ditch Depth	Major rockslide potential				
Slope Angle	Sight Distance	Dominating rockfall mode: Block-in-matrix / Sedimentary rock / Crystalline rock				
Ditch Slope	Speed Limit	Dominating sight distance: Horizontal / Vertical				
Ditch Width	ADT	Mitigation effectiveness: A B C D F				
Rating		Cut Slope / Total Slope (Circle one)	3 Points	9 Points	27 Points	81 Points
Slope Height	25 to 50 ft	50 to 75 ft	75 to 100 ft	>100 ft		
Rockfall Frequency	> 2 years	1 to 2 years	Yearly, seasonal	Year round / severe events		
Average Slope Angle Score	0 to 2	2 to 4	4 to 8	> 8		
Launching Features	None (smooth slope)	Minor (< 2 ft. surface variation)	Many (2 to 6 ft. surface variation)	Major (> 6 ft. surface variation)		
Ditch Catchment	95% to 100% / Class 1	65% to 94% / Class 2	30% to 64% / Class 3	< 30% / Class 4 / 2 Major launching features		
Annual Precipitation	< 10 inches	10 to 20 inches	20 to 35 inches	> 35 inches		
Annual Freeze Thaw Cycles	1 to 5	6 to 10	11 to 15	16 or more		
Seepage / Water	Dry	Damp / wet	Dripping	Running water		
Slope Aspect	N	E, W, NE, NW	SE, SW	S		
Degree of Under-Cutting	0 to 1 ft	1 to 2 ft	2 to 4 ft	> 4 ft		
Jar Slake	6	5	3 to 4	1 to 2		
Degree of Interbedding	1 to 2 weak interbeds, < 6 in.	1 to 2 weak interbeds, > 6 in.	> 2 weak interbeds, < 6 in.	> 2 weak interbeds, > 6 in.		
Rock Character	Homogenous / massive	Small faults / strong veins	Schist / shear zones < 6 in.	Weak pegmatite / micas / shear zones > 6 in.		
Degree of Overhang	0 to 1 ft	1 to 2 ft	2 to 4 ft	> 4 ft		
Weathering Grade	Fresh	Surface staining	Slightly altered / softened	Core stones		
Block Size / Volume	<1 ft / <1 cy	1 to 2 ft / 1 to 3 cy	2 to 5 ft / 3 to 10 cy	>5 ft / >10 cy		
Number of Sets	1	1 plus random	2	> 2		
Persistence, Orientation	< 10 ft and dips into slope	> 10 ft and dips into slope	< 10 ft and daylight out of slope	> 10 ft and daylight out of slope		
Aperture	Closed	0.1 to 1 mm	1 to 5 mm	> 5 mm		
Weathering Condition	Fresh	Surface staining	Granular infilling	Clay infilling		
Friction	Rough	Undulating	Planar	Slickensided		
Block Size (x3)	< 1 ft	1 to 2 ft	2 to 5 ft	> 5 ft		
Block Shape (x3)	Tabular	Blocky	Blocky to angular	Rounded and smooth		
Vegetation (x3)	Fully vegetated	Patchy vegetation	Isolated plants	None		
Total Hazard Score:						
Sight Distance	> 80 %	60 % to 80 %	40 % to 60 %	< 40 %		
Avg. Vehicle Risk	0 to 24%	25 to 49%	50 to 74%	75% or more		
No. of Accidents	0 to 2	3 to 5	6 to 8	9 and over		
Total Risk Score:						

Additional Rater's Comments:

2.2 Slope Conditions

This category includes parameters that relate to the slope's characteristics and dimensions. These parameters address the likelihood of a rock actually reaching the roadway if it does dislodge from a slope. Procedures that were used for measurement are provided in each parameter's description.

2.2.1 Slope Height

This parameter was not changed from the original rating system with the exception of the option to rate the total slope height in addition to the cut slope height (which was rated in the original system). Total slope height is measured from the road to the highest point of potential rockfall source, and it includes the entire slope beyond CDOT's right of way. If there is a rockfall hazard high up on the slope beyond the cut, the total slope height is measured. If only the cut slope is being rated, the maximum height of the cut is considered.

A range finder and slope indicator was used to measure the slope height at all 200 sites (see Figure 2.1). Equation 2.1 was then used to calculate slope height.

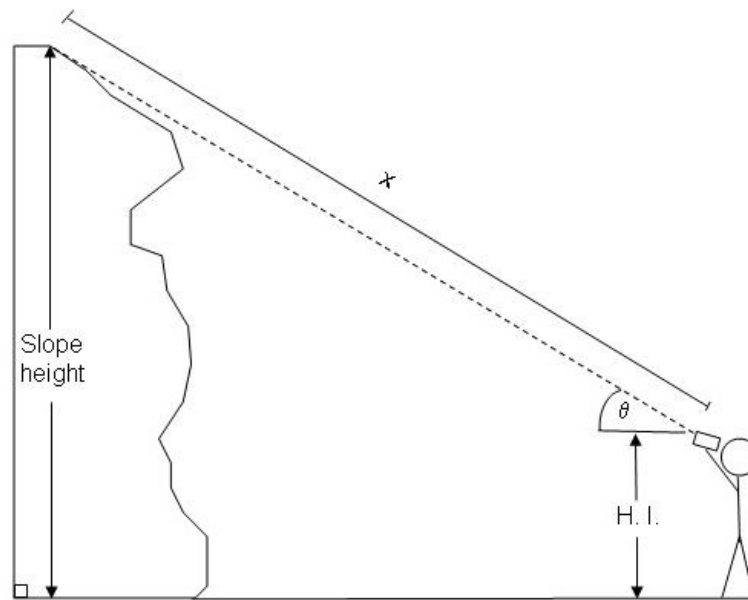

Figure 2.1: Methodology to determine slope height.

(Equation 2.1)

Slope Height = H. I. + X Sin θ
 H. I. = Height of the instrument.
 X = Reading from the range finder.
 θ = Angle read from the slope indicator.

2.2.2 Rockfall Frequency

The original rockfall history parameter was changed to Rockfall frequency. The different rating scores were changed to remove the subjectiveness from the original scoring. The original scoring used “few, occasional, many, constant.” The recommended change is occurrence of rockfall per specific time, such as seasonal rockfall occurrence, or rockfall every 1-2 years.

Unfortunately, specific data for the actual frequency of rockfall at a specific site is not available. Therefore, this parameter was scored for all 200 slopes simply by using the scores from CDOT's current RHRS for "observed history." These scores were based off of the maintenance reports that were obtained during drive-throughs when this system was originally created (Stover, 1992). Given that these drive-throughs were conducted prior to 1992, the scores may no longer be accurate for each site, given that the slope conditions may have changed, or mitigation structures may have been installed. More current information should be used to score the current rockfall frequency at a site, however, no such data exists, and conducting additional drive-throughs or interviews with maintenance crews was beyond the scope of this project.

2.2.3 Average Slope Angle

Colorado's current RHRS separates the slope angle into the following categories: 35° - 45°, 45° - 55°, 55° - 65°, and > 65°. These categories are scored 3, 9, 27, and 81 respectively. The score for the slope angle was changed based on the research conducted by Maerz et al. (2005), using the Colorado Rockfall Simulation Program (CRSP). The slope angle influences the trajectory of the rockfall, thus affects the hazard to the roadway below. Figure 2.2 was adapted from Maerz et al. (2005), and was used to score the slope angle based on the consequence rating from the likelihood that a rock will reach a roadway due to various rockfall trajectories from different slope angles. Rocks falling from slopes with angles that have higher scores are more likely to end up in the roadways below.

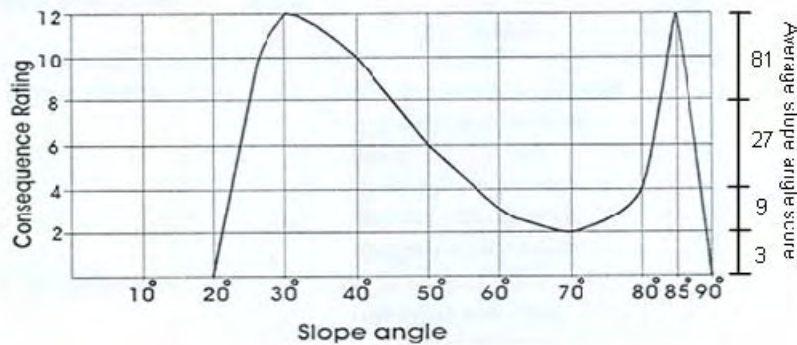

Figure 2.2: Consequence rating from rockfall as a function of slope angle and corresponding average slope angle scores (modified from Maerz et al., 2005).

Slope angle was measured with a slope indicator after walking enough distance from the slope in order to obtain a profile view of the slope face. Often, a natural slope existed above a cut face. If there was not a rockfall hazard present above the cut face, the slope angle was taken from the cut. If there was a rockfall hazard beyond the cut face higher up on the slope, both the cut slope angle and the natural slope angle above the cut's brow were measured and recorded. The measurement that posed the higher hazard to the roadway was used to score the slope angle.

2.2.4 Launching Features

The original criteria for launching features were very subjective, and a more descriptive approach was deemed necessary. The location of the launching features up the slope will greatly affect whether or not rocks will even be launched onto the roadway, therefore some subjectivity and engineering judgment will still be required. Pictures and descriptions are included below as examples for the new rating.

None: Indicates a relatively smooth slope, with little or no topographic variation along the slope profile (Figure 2.3). These slopes receive 3 points.

Minor: Indicates a slope profile that has small topographic / material variations that could cause launching of boulders, such as the presence of small ridges extending < 2 feet from the slope surface, or occasional boulders on the surface (Figure 2.4). These slopes receive 9 points.

Many: Indicates a slope profile with several topographic / material variations that could cause launching of boulders, such as the presence of ridges or benches extending from 2-6 feet from the slope surface (Figure 2.5). These slopes receive 27 points.

Major: Indicates a highly irregular slope profile with large rock outcrops, or the presence of large ridges or benches extending more than 6 feet from the slope surface (Figure 2.6). These slopes receive 81 points.



Figure 2.3: Examples of slopes with no launching features present (score of 3). Picture on left taken from CO Highway 72 in Boulder County. Picture on right taken from CO Highway 14 in Larimer County.



Figure 2.4: Examples of slopes with minor launching features present (score of 9). Picture on left taken from CO Highway 72 in Boulder County. Picture on right taken from U.S. 6 in Clear Creek County.



Figure 2.5: Examples of slopes with many launching features present (score of 27). Picture on left taken from U.S. 6 in Jefferson County. Picture on right taken from U.S. 34 in Larimer County.



Figure 2.6: Examples of slopes with major launching features present (score of 81). Picture on left taken from CO Highway 24 in El Paso County. Picture on right taken from U.S. 6 in Clear Creek County.

2.2.5 Ditch Catchment

Ditch catchment was modified significantly for the new RHRS. The original rating criteria for this parameter are very subjective. The new RHRS will rate both the ditch dimension effectiveness and the ditch shape effectiveness. The highest of the two scores will be used to rate the ditch catchment.

It is recommended to use a percentage based on actual ditch dimensions vs. required Ritchie dimensions in order to rate the ditch dimension effectiveness (Flatland, 1993; NYDOT, 1996). The modified system will do this based on Equation 2.2:

$$\text{Ditch Dimension Effectiveness} = \frac{(D_a + W_a)}{(D_r + W_r)} \times 100\% \quad (\text{Equation 2.2})$$

D_a = Actual depth of the ditch.

W_a = Actual width of the ditch.

D_r = Ritchie design depth based on slope height and angle (from Fig. 1.2).

W_r = Ritchie design width based on slope height and angle (from Fig. 1.2).

Figure 2.7 illustrates the various ranges of actual vs. required ditch dimensions and corresponding scores. The values measured in the field can be plotted onto this figure to determine the ditch catchment score. The divisions for each scoring category were created arbitrarily.

The ditch width and depth were measured using measuring tapes. The ditch dimensions often varied considerably across a single site (variations in widths encountered were as much as 10 feet, and depths could range from flat to 2 feet deep). Variations in ditch dimensions were recorded, and the worst case present was used to score the ditch catchment parameter. If a slope produces regular rockfall, rock will most likely reach the roadway within the slope segments with the smallest ditch.

Ditch shape effectiveness is rated based on the off-shoulder slope angle or on the presence of any barriers (Jersey barrier, rockfall fence, guard rail) between the ditch and the road (Ritchie, 1963; Badger & Lowell, 1992; Maerz et al. 2005; NYDOT, 2003).

Table 2.2 can be used to identify the class and corresponding score.

Scores for actual ditch dimensions vs. required ditch dimensions

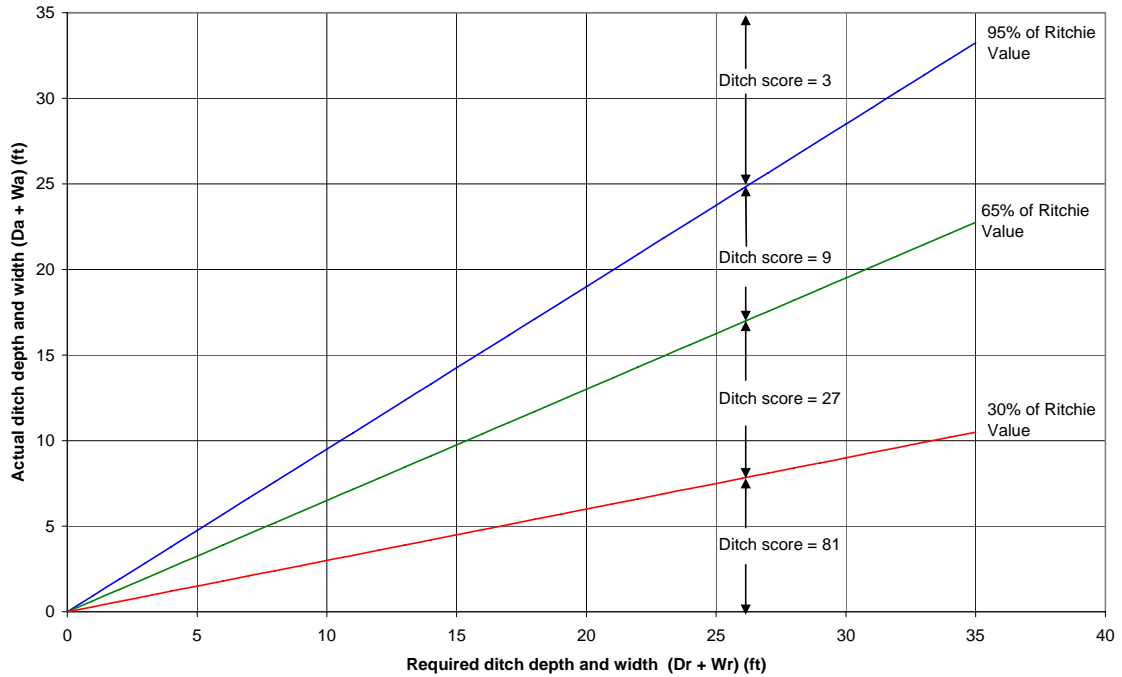

Figure 2.7: Actual vs. required ditch dimensions and corresponding scores.

Table 2.2: Ditch Shape Effectiveness based on off shoulder slope angle

Ditch Shape Effectiveness				
	Class 1 (score 3)	Class 2 (score 9)	Class 3 (score 27)	Class 4 (score 81)
Off-shoulder slope	> 30° or presence of any barrier	21° - 30°	11° - 20°	0° - 10°

The ditch shape was measured using a slope indicator. A flat object, such as a clip board, was placed on the off-shoulder slope, and the slope indicator was placed on this object to measure the off-shoulder slope angle. This procedure was repeated in several locations along a ditch at a given site to record a range of off-shoulder slope angles. Similarly to the ditch dimensions, the ditch shape at a given site often varied considerably, and the worst case present was used for the score.

Barrett & White (1991), suggest that Colorado's steep and severely irregular slopes often make Ritchie ditch designs useless. Therefore, if the slope is rated with launching features at 81 or higher (major), ditch effectiveness automatically received a rating of 81.

2.3 Climate Conditions

Colorado's original system lumped together the following categories: precipitation, seepage, and exposure. Apparently the meaning of the "exposure" factor is unknown and not even in use (Ortiz, 2006). The modified RHRS uses the following parameters: annual precipitation, annual freeze thaw cycles, seepage / water, and slope aspect.

Freeze thaw cycles and slope aspect are new categories, included to account for their documented effects on rock slope instability (Flatland, 1993; Nichol & Watters, 1983; Romana, 1988; Moore, 1986; Eliassen & Ingraham, 2000; Senior, 1999; Arndt et al., 2003; Mazzoccola & Hudson, 1996; Watters, 1998; Barrett & White, 1991).

2.3.1 Annual Precipitation

Annual precipitation now specifies actual amounts of rainfall and snowfall to remove the subjectiveness from the “low, moderate, high” criteria that was originally used. The average annual precipitation can be read from Figure 2.8.

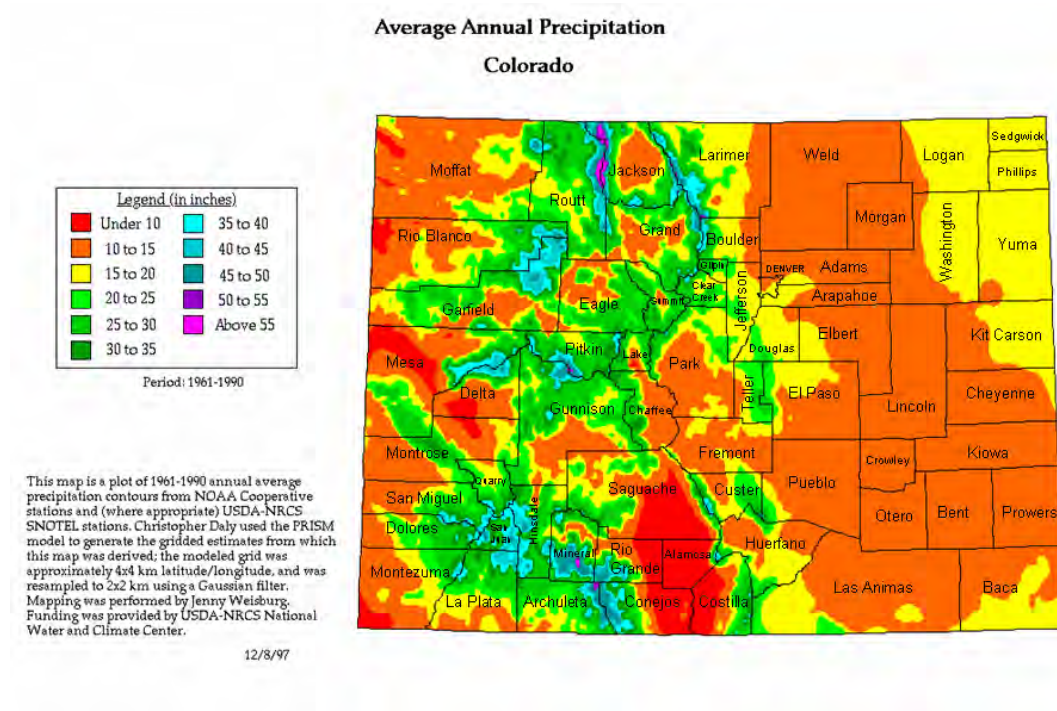

Figure 2.8: Colorado’s average annual precipitation from 1961 to 1990. Map was obtained from Western Regional Climate Center (2006).

In order to estimate which precipitation zone a site was located in, a more detailed road atlas was used in the field. The Colorado Atlas and Gazetteer 7th Edition (Delorme,

2002) was used to obtain the approximate location of a site within a county, and then compared to Figure 2.8 to obtain a score for that site.

2.3.2 Annual Freeze Thaw Cycles

Arnold et al. (1996) performed a nationwide study using over 5,000 weather stations to quantify the moist freeze/thaw index using daily data. The moist freeze/thaw index is defined by Lienhart (1988) as the product of the monthly percentage of days with precipitation exceeding 0.01 inch and the number of freezing cycle days. Freezing cycle days are defined as the annual average number of days when the daily temperature fluctuates above and below freezing (Lienhart, 1988). Arnold et al. (1996) tallied the number of freeze/thaw cycles using Lienhart's (1988) freeze thaw index at the 5,000 sites by taking the mean temperature, mean rainfall, and moisture conditions in the upper one inch of surficial materials over a one year period. This information was used to rate the geographical distribution of moist freeze thaw cycles annually for Colorado. Figure 2.9 summarizes the average number of freeze thaw cycles expected for regions of Colorado. The scoring divisions in the modified RHRS are based on this data.

The Colorado Atlas and Gazetteer 7th Edition (DeLorme, 2002) was used to estimate which freeze thaw zone a site was located in, following the same procedure used to estimate the appropriate precipitation zone for a site.

Average Annual Freeze - Thaw Cycle Distribution for Colorado

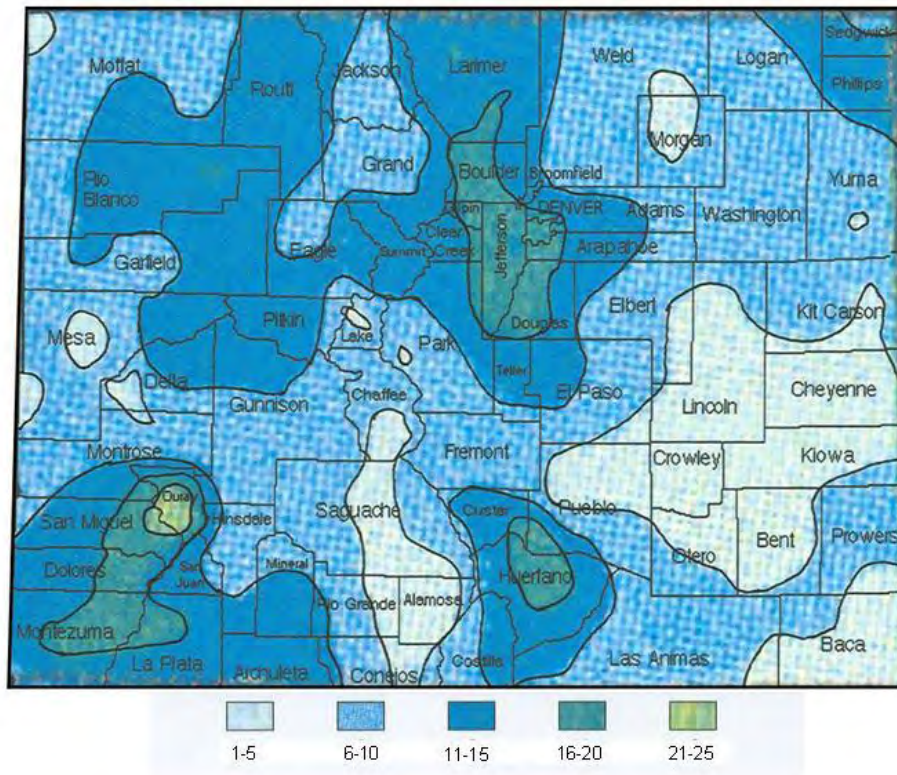

Figure 2.9: Colorado's average annual freeze/thaw cycle distribution. One cycle represents a 24 hour period when the temperature fluctuates above and below freezing conditions, and the moisture conditions in the surficial materials were sufficient to create freeze/thaw conditions. Map was derived from Arnold et al. (1996).

2.3.3 Seepage / Water

Seepage or the presence of water on the slope was changed to more descriptive adjectives rather than the original “none, some, moderate, high.” The modified version

uses the following descriptions: dry, damp / wet, dripping, running water. These are scored 3, 9, 27, and 81, respectively.

The field work conducted to rate the 200 sites occurred from July to September of 2006. There were very few slopes encountered in which active seepage was observed within the rock mass due to the dry climate conditions in Colorado during this time of year. However, evidence on rock faces such as water marks or streaks and zones of discoloration imply that seasonal seepage does occur. Therefore, the slopes were rated subjectively based on the abundance of these features plus any observations of current active seepage to estimate the maximum seasonal seepage that may occur at a given site (Figure 2.10).

2.3.4 Slope Aspect

Slope aspect is a new factor, and is based on evidence that south facing slopes experience far more freeze/thaw cycles annually than north facing slopes (Flatland, 1993; Mazzoccola & Hudson, 1996; Watters, 1998). North facing slopes are in the shade most of the day, so they will experience the least amount of temperature variation throughout a given day and are rated the lowest. East, west, northeast, and northwest will experience some sunshine through the day, and are rated second to lowest. Southeast and southwest facing slopes will experience more sunshine, and are rated second highest. Directly south facing slopes will experience the most temperature variations over a 24 hour period, and are rated the highest.

Slope aspect also has an influence of the establishment of vegetation on a slope, which has an influence on erosion of block-in-matrix slopes. Branson (1990) performed an investigation comparing vegetation and geomorphic processes for north and south facing slopes on Green Mountain, near Lakewood, CO. South facing slopes experienced more solar radiation during the day all year round. Higher solar radiation allows for



Figure 2.10: Seepage on a cut slope face. Picture on left shows a cut slope on U.S. 6 that was dry when the rating was performed, yet the water stains imply seasonal seepage. This slope received a score of 27 for the Seepage / water parameter. The Picture on the right shows a cut slope on CO Highway 24 that was dripping, and therefore also received a score of 27.

higher evaporation rates on south facing slopes. This creates drier soils that do not allow vegetation to establish. South facing slopes are therefore characterized by more exposed soil and bedrock, more surface runoff, and higher erosion and sedimentation rates. This produces a greater potential for debris flows and mass wasting events. North facing slopes on the other hand, experience much less evaporation throughout the year. Vegetation becomes more established so erosion is reduced.

2.4 Geological Conditions

With Colorado's current RHRS (in addition to other states that adopted Oregon's original RHRS), a 100-ft high slope with no ditch, high traffic volumes, minimal sight

distance, and a high slope angle would be rated with a very high score. However, such a slope may not even have a rockfall hazard due to favorable rock and discontinuity conditions, and the high score could be misleading (Flatland, 1993). Therefore, several additional parameters were included for the geological factors and discontinuity conditions in order to weight them more than the other parameters that do not contribute directly to rockfall potential. Three types of geologic conditions are considered separately:

1. Sedimentary rock where undercutting and differential erosion tend to control rockfall.
2. Crystalline rock where the rock mass inhomogeneity and fractures tend to control rockfall.
3. Block-in-matrix materials (colluvium, glacial till, debris flow deposits etc.) where erosion of the matrix material and subsequent raveling of the larger blocks tends to control rockfall.

In addition, CDOT's current RHRS was modified to include several additional parameters to rate the discontinuities within rock slopes. The stability of a rock mass can be more accurately assessed given more useful information on the character and condition of discontinuities within a rock slope (Bienawski, 1989; Barton, et al., 1974). The discontinuities will be rated on slopes that are characterized by either sedimentary or crystalline rocks, not for block-in-matrix slopes.

2.4.1 Sedimentary Rock: Degree of Undercutting

Rockfall in sedimentary rock is generally dominated by differential erosion and weathering in various lithologies with resulting undercutting and failure (Figure 2.11)

(Vandewater et al., 2005; Shakoor, 2005). The amount of undercutting reflects the degree of lithological variation within a rock slope (Vandewater et al., 2005), and was found to contribute largely to the rockfall potential for a sedimentary outcrop (Shakoor, 2005). This is one of the parameters rated in the modified RHRS, and it contains specific numerical criteria to remove subjectiveness.



Figure 2.11: Degree of undercutting illustrated in sedimentary slope on CO Highway 24 in El Paso County.

2.4.2 Sedimentary Rock: Jar Slake

Typically, undercutting in sedimentary units involves a weaker shale unit interbedded with a more competent sandstone or limestone. For this reason, slake durability was recommended in the modified RHRS as a contributor to rockfall as well (Senior,

1999; Shakoor, 2005). Shakoor (2005) performed a statistical analysis on the dominant factors that contribute to rockfall in Ohio, and found that slake durability was one of the most important. Given that a slake durability test is not a field friendly test, simple 30 minute jar slake tests can be performed and correlated to slake durability indices for shale rocks (Santi, 2006). These results provide a direct measure of the difference in weatherability and erosion of the slope materials. Figure 2.12 illustrates the different reactions that can occur with a jar slake test, and their corresponding ratings. These ratings are used to score the jar slake parameter. Sedimentary rocks (sandstone and limestone) that show no slaking reaction to the test are given a jar slake score of 6 (3 points in the RHRS) based on Figure 2.12.

2.4.3 Sedimentary Rock: Degree of Interbedding

A statistical analysis was also performed to identify which geologic factors contribute the most to rockfall in the state of Tennessee (Vandewater et al., 2005). They observed that the severity of a rockfall and the rockfall type are largely dependent on the degree of lithological variation and the layer thickness within a rock slope (Vandewater et al., 2005). The degree of inter-bedding was included in the modified RHRS for these reasons (Figure 2.13). The main characteristics considered are the number of weak interbeds within the rock slope, and their corresponding thicknesses.

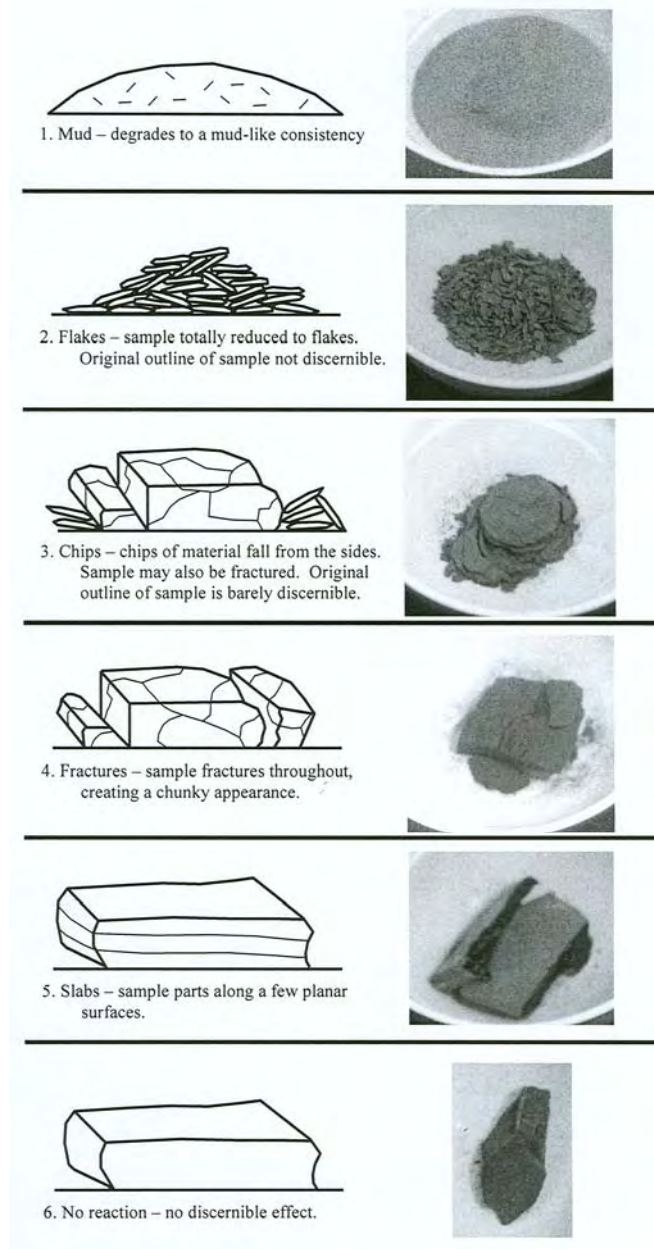

Figure 2.12: Various reactions to jar slake tests and corresponding ratings. Figure obtained from Santi (2006).

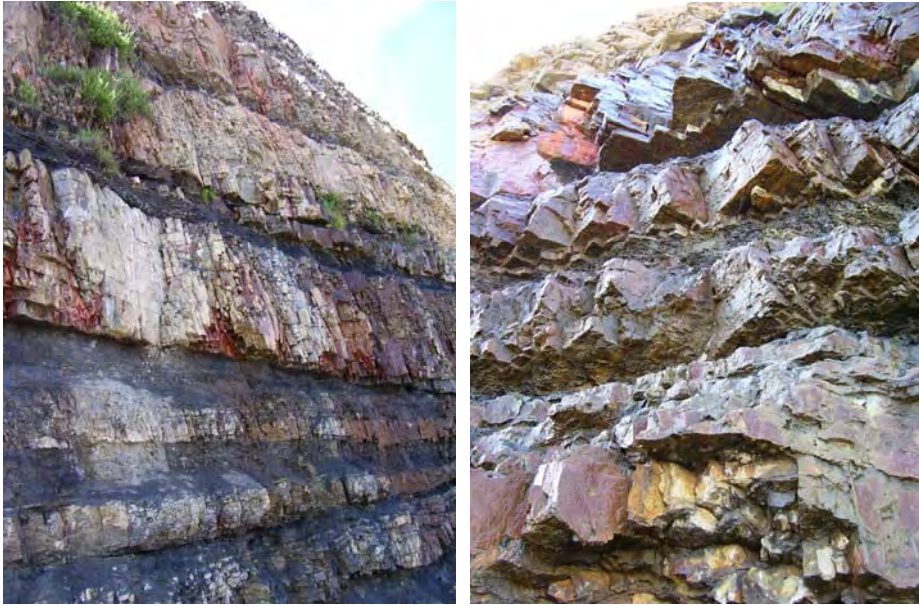

Figure 2.13: Degree of interbedding illustrated in a sedimentary slope on I-70 in Summit County.

2.4.4 Crystalline Rock: Rock Character

Rockfall in crystalline rocks is largely controlled by the overall rock mass homogeneity. The first factor, rock character, deals with specific characteristics of metamorphic / igneous rock in Colorado. Given that lithological variation was found to be a dominant controlling factor for rockfall in sedimentary rock (Vandewater et al., 2005), similar behavior is expected to occur in crystalline rock types as well. The rating from best to worst is as follows:

- “Homogenous / massive” implies little mineralogical or lithological variation within the rock mass (i.e. few zones of weakness) (Figure 2.14).
- “Small faults / strong veins” is self explanatory, however it should be noted that the presence of veins in this category implies little loss of strength of the rock

mass (i.e. they are not major zones of weakness, but exist in a crystallized and unweathered state) (Figure 2.15).

- “Schist / shear zones < 6 inches” implies zones of schistosity or fabric within the rock mass that may contribute to instability. Small shear zones will obviously weaken the rock mass and create avenues for increased chemical and physical weathering (Figure 2.16).
- “Weak pegmatites / micas / shear zones > 6 inches” seems to be the dominant factor controlling large scale instability and rock slope failures on Colorado Highways based on previous events. The 2005 failure on U.S. 6 near Golden was a result of this condition (Figure 2.17).



Figure 2.14: Example of homogenous / massive crystalline rock on CO highway 24 in El Paso County (score of 3).



Figure 2.15: Example of strong veins within crystalline rock on CO Highway 119 in Boulder County (score of 9).



Figure 2.16: Example of schist / shear zones < 6 inches within crystalline rock on I-70 in Clear Creek County (score of 27).



Figure 2.17: Example of weak pegmatites / micas / shear zones > 6 inches within crystalline rock on U.S. 6 in Jefferson County (score of 81).

2.4.5 Crystalline Rock: Degree of Overhang

Although differential erosion does not typically lead to undercutting in crystalline rock, frequent rockfall on the slope can create overhanging features and unstable conditions (Figure 2.18) (Senior, 1999; Maerz et al. 2005). Therefore, the degree of overhang was considered for crystalline rock in the modified RHRS similar to undercutting in sedimentary rock.



Figure 2.18: Examples of differing degrees of overhang in crystalline rock. Picture on left was taken on I-70 in Clear Creek County and scored 3 (0 – 1 ft overhang). Picture on right was taken on CO 119 in Boulder County and scored 81 (> 6 ft. overhang).

2.4.6 Crystalline Rock: Weathering Grade

As with sedimentary rock, the degree of weathering was also considered a major factor contributing to rockfall potential in crystalline rock. Specific, self-explanatory definitions were used as criteria for this parameter, and reflect typical weathering grades of crystalline rocks (Figure 2.19). It should be noted that this rating parameter takes into account the degree of weathering of the intact rock, not the weathering grade along the surfaces of discontinuities.



Figure 2.19: Examples of differing degrees of weathering grade within intact crystalline rock. Picture on left was taken on U.S. 6 in Jefferson County and scored 3 (fresh intact rock). Picture on right was taken on CO 72 in Boulder County and scored 81 (intact rock weathered to corestones).

2.4.7 Discontinuities: Block Size / Volume

The discontinuity number and spacing largely control the mode, size, and frequency of rockfall occurrence (Vandewater et al., 2005; Senior, 1999; Maerz et al., 2005; Romana, 1988; Nichol & Watters, 1983; Mazzoccola & Hudson, 1996). Block size inherently gives information on discontinuity spacing, since block size is related to this characteristic. Rockfall events can be characterized by either single blocks or by a volume of material of varying sizes (Figure 2.20). The appropriate category should be

used for the event that seems to occur most frequently or is most likely to occur at a given site. This information can be obtained from maintenance records, or from observations of the rock slope (i.e. multiple potentially unstable blocks vs. one or two).

The block size / volume parameter is important in addressing the degree of severity of a rockfall event. Larger blocks possess more kinetic energy when they fall and are thus more likely to roll farther when they reach the base of the slope, and are more likely to end up in the roadway. Larger blocks also will cause more damage during a collision with a vehicle. In addition, larger blocks falling down a rock face are more likely to dislodge other blocks and result in additional rockfall.



Figure 2.20: Discontinuity block size / volume: Picture on left was taken on CO 9 in Summit County. The bedding planes in this shale create block sizes no larger than chips, therefore volume likely to fail is used. It was estimated that between 3-10 cubic yards could fail from this slope (score of 27). Picture on right was taken on CO 119 in Boulder County and represents a slope where individual blocks likely fall. Block size was 2-5 ft (score of 27).

2.4.8 Discontinuities: Number of Sets

The number of discontinuity sets was added to the modified RHRS to reflect the importance of increased infiltration, frost wedging, and chemical weathering that occurs within more broken up rock masses (Figure 2.21) (Senior, 1999; Maerz et al., 2005; Romana, 1989; Mazzoccola & Hudson, 1996; Nichol & Watters; Vandewater et al., 2005). The more discontinuities a rock slope has, the more avenues exist for physical and chemical weathering to occur (Vandewater et al., 2005; Senior, 1999; Maerz et al., 2005; Romana, 1988; Nichol & Watters, 1983; Mazzoccola & Hudson, 1996).



Figure 2.21: Number of discontinuity sets: Picture on left was taken on U.S. 6 in Jefferson County. This slope had 3 distinct discontinuity sets plus random discontinuities (score of 81). Picture on right was taken on CO 24 in El Paso County. The discontinuity sets consisted of bedding planes and an additional set striking into the slope (score of 27).

2.4.9 Discontinuities: Persistence and Orientation

Persistence and orientation were changed in the modified RHRS by attaching numbers from Pierson and Van Vickle (1993), used to define continuous vs. discontinuous persistence (> 10 ft. and < 10 ft., respectively). The orientation was changed to define “adverse” as day-lighting out of the slope face, and “favorable” as dipping into the slope face (Figure 2.22).



Figure 2.22: Discontinuity persistence and orientation: Picture on left was taken on CO 119 in Gilpin County. The discontinuities were highly persistent (>10 ft.) but had a favorable dip direction with respect to the roadway (score of 9). Picture on right was taken on CO 119 in Boulder County. The discontinuities were highly persistent (>10 ft.) and had an adverse dip direction with respect to the roadway (score of 81).

2.4.10 Discontinuities: Aperture

Several authors make the recommendation of adding discontinuity aperture to a RHRS in order to account for the increased chance of water infiltration, frost wedging,

and associated ravelling (Senior, 1999; Maerz et al., 2005; Romana, 1989; Mazzoccola & Hudson, 1996). Simple and measurable numerical values are used for this category (Figure 2.23).



Figure 2.23: Discontinuity aperture: Picture on left was taken on CO 9 in Summit County. The discontinuities had an aperture of > 5 mm (score of 81). Picture on right was taken on U.S. 6 in Clear Creek County. The discontinuities had an aperture of 0.1 – 1 mm (score of 9).

2.4.11 Discontinuities: Weathering Condition

The weathering condition of the surfaces of discontinuities was added because several authors suggested that both physical and chemical weathering are another primary factor contributing to rockfall (Figure 2.24) (Flatland, 1993; Maerz et al., 2005; Eliassen & Ingraham, 2000; Barrett & White, 1991; Ritchie, 1963). The strength of discontinuity

surfaces has a major influence on rockfall potential, and chemical weathering reduces the mechanical properties along the discontinuity surfaces by reducing cohesion and friction (Piteau, 1970; Flatland, 1993; Mazzoccola & Hudson, 1996). Both chemical weathering and hydrothermal alteration degrade the strength of the entire rock mass (Patton & Deere, 1970; Romana, 1989). In addition, evidence of chemical weathering implies the presence of water along the discontinuity surfaces, which creates elevated pore pressures and frost wedging that contribute significantly to rockfall occurrence (Anderson et al., 1999).



Figure 2.24: Discontinuity weathering: Picture on left was taken on I-70 in Clear Creek County. The discontinuities are infilled with a granular material (score of 27). The picture on the right was taken on CO 119 in Boulder County. The discontinuities are surface stained (score of 9).

2.4.12 Discontinuities: Friction

The friction of discontinuities is now considered as a separate category. The rating procedure is similar to CDOT's original friction parameter, except that only the smoothness / roughness of the discontinuity faces are considered (Figure 2.25). The original RHRS included infilling materials for this parameter, but the modified RHRS accounts for infilling material in the weathering condition of the discontinuities. The friction along the discontinuities is estimated by both observation and feeling the discontinuity surfaces. Rough surfaces have distinct and sharp asperities and a rough texture when one runs their hand over them. Undulating implies that the asperities have been sheared, and are more rounded and smooth. Planar implies that there are no asperities at all, but rather smooth surfaces in contact with one another. Slickensided implies that movement has occurred in the past resulting in the formation of slickenlines on the discontinuity surfaces, in which case shear strength would be reduced to the residual value.

2.4.13 Block-in-Matrix: Multiplier

In order to rate all of the geologic factors equally, all of the ratings for the block-in-matrix parameters will be multiplied by a factor of 3. Sedimentary and crystalline rock slopes have 9 rating parameters due to the addition of the discontinuity rating parameters. Block-in-matrix slopes only have 3 parameters to rate. This multiplier is used to avoid having rock slopes weighted more than block-in-matrix slopes, when both could have equal rockfall potential.



Figure 2.25: Discontinuity friction: Picture on left was taken on U.S. 34 in Larimer County. The discontinuity surfaces were perfectly smooth and planar at this site (score of 27). Picture on right was taken on CO 119 in Boulder County. The discontinuities were very rough and irregular (score of 3).

2.4.14 Block-in-Matrix: Block Size

The block size will be rated for these materials on the basis that larger blocks possess more kinetic energy as they roll down the slope, and therefore have a more likely chance of reaching the roadway (Figure 2.26) (Senior, 1999; Maerz et al. 2005; Pierson & Van Vickle, 1993). Although larger blocks present more of a hazard, it is likely that smaller blocks fall much more frequently from these slopes. It would take much more erosion of matrix material to dislodge a five-foot diameter rock than a one-foot diameter

rock. The scoring for block size was performed keeping this in mind. Scores were not assigned simply based on the largest blocks in the slope, but rather given to the largest blocks that are likely to become unstable.



Figure 2.26: Block-in-matrix block size: Picture on right was taken on CO 119 in Boulder County. The unstable rocks were all < 1 ft. in diameter (score of 3). Picture on left was taken on CO 14 in Larimer County. Unstable blocks were 2-5 ft. in diameter (score of 27).

2.4.15 Block-in-Matrix: Block Shape

The Tennessee DOT has a separate category for rockfalls caused by raveling of block-in-matrix materials. They propose rating the block shape as it has a direct effect on whether the rocks will be able to roll down the slope or not. Colluvium or talus containing large tabular blocks will not pose as great a risk as a glacial deposit with rounded boulders within the matrix (Figure 2.27) (Vandewater et al., 2005).



Figure 2.27: Block-in-matrix block shape: Picture on left was taken on I-70 in Clear Creek County. The slope contained several rounded blocks (score of 81). Picture on right was taken on U.S. 34 in Larimer County. The slope contained tabular blocks of mica schist (score of 3).

2.4.16 Block-in-Matrix: Vegetation

Vegetation can have both positive and negative effects on rockfall. Root wedging and the force of wind on vegetation can enhance physical erosion and further loosen rocks on rock slopes. However, it is generally agreed upon that vegetation helps to enhance the stabilization of soil slopes and block-in-matrix slopes by reducing the amount of erosion of the matrix materials (Figure 2.28) (Miller, 2003; Anderson et al., 1999; Arndt et al., 2003). The Idaho DOT includes a parameter for vegetation when rating the potential for raveling or major debris flows on their soil slopes. The modified RHRS uses a similar approach to rate the effects of vegetation on these materials.



Figure 2.28: Block-in-matrix vegetation: Picture on left was taken on CO 72 in Boulder County. This slope had no vegetation (score of 81). Picture on right was taken on CO 119 in Boulder County. This slope was fully vegetated (score of 3).

2.5 Traffic

Finally, the traffic conditions are considered. These parameters are unchanged from CDOT's current RHRS (with the exception of rating average vehicle risk instead of average daily traffic). These parameters rate the overall risk of a vehicle having an accident due to rockfall occurrence. The sum of the scores from these parameters yields the Total Risk Score. Maerz et al. (2005), recommends that risk and hazard be rated separately in a RHRS. The sum of the scores from the categories for slope, climate, and geological conditions summarize the actual rockfall hazard that a slope presents, and

yield the Total Hazard Score. CDOT may want to consider comparing overall risk to overall hazard when choosing which slopes to remediate.

2.5.1 Sight Distance

The percent decision sight distance is defined by Equation 2.3:

$$\frac{\text{Actual Decision Sight Distance}}{\text{Required Decision Sight Distance}} \times 100\% \quad (\text{Equation 2.3})$$

Actual decision sight distance is defined as the distance on a roadway that a six inch object placed on the edge of the road is visible to a driver. Required sight distance is tabulated in Table 2.3.

Table 2.3: Required decision sight distance based on posted speed limits (Pierson and Van Vickle, 1993).

Posted Speed Limit (mph)	Decision Sight Distance (ft)
25	375
30	450
35	525
40	600
45	675
50	750
55	875
60	1,000
65	1,050

A range finder was used to measure sight distance for all 200 slopes that were rated. A hard hat (six inch object) was placed on the edge of the roadway, and the maximum distance that the hard hat was visible from the center of the road was measured using the range finder. There were several sites in which the slope was on a blind corner, and traffic conditions were too hazardous to measure this distance from the center of the road. The sight distance in these cases was measured by standing on the edge of the road adjacent to the rock slope, and taking the distance to where the centerline first appears around the corner (Figure 2.29)



Figure 2.29: Measuring sight distance on a blind corner from the edge of the roadway.

When travelling through a segment length for a given rockfall site, a wide variety of sight distances is often available to a driver (the slope may be approached from a straight-of-way from one direction, and a curve from the opposite direction). The minimum sight distance available as a driver approaches a potential rockfall site was used to score the sight distance parameter.

2.5.2 Average Vehicle Risk

Average Vehicle Risk (AVR) gives an idea of the amount of time a vehicle is within the segment length of a rockfall prone area. AVR takes into account the Average Daily Traffic (ADT, which is obtained from the CDOT traffic data website), speed limit, and the length of the slope. AVR is calculated from Equation 2.4 (Pierson & Van Vickle, 1993).

(Equation 2.4)

$$AVR = 100 \times \frac{ADT \text{ (cars per day)} \times \text{Slope Length (miles)}}{24 \text{ (hours per day)} \times \text{Posted Speed Limit (miles per hour)}}$$

The equation for AVR can yield numbers greater than 100, which indicates that there is more than one vehicle within the slope segment at any given time.

It should be mentioned that Washington State DOT considers the roadway importance when selecting sites to receive mitigation. Rather than repair the worst slopes within the state, they find the most important roadways and address their most hazardous slopes first (Lowell & Morin, 2000). The ADT for a site can be used similarly to prioritize the most hazardous slopes along the most traveled roadways.

2.5.3 Number of Accidents

This information was obtained from the CDOT Traffic Safety Office, 2006. A database was used that listed all accidents caused by either “rocks in roadway” or “large boulder” from January 1, 1976 to December 31, 2004. These accidents are reported with the highway number and milepost (to the tenth of a mile), allowing a summation of rockfall related accidents at a given site. The accuracy of this data is not perfect, given that the Colorado State Highway Patrol does not differentiate in their accident reports whether “rocks in roadway” were caused from rockfall from a slope or from rocks falling off of a truck. In addition, there is no information provided as to whether the rock causing the accident was stationary or moving. There is also no information given as to whether a vehicle collided with a rock that was actually in the roadway, or if the vehicle swerved off of the road and collided with a rock on the shoulder (Ortiz, 2006).

2.6 Remarks

In addition to rating each slope according to the above parameters, it was considered necessary to include additional remarks concerning major rockslide potential, the dominating rockfall mode at a site, the direction of sight distance, and the mitigation effectiveness.

2.6.1 Major Rockslide Potential

The geological conditions of rock slopes within Colorado’s highway corridors create a significant rockslide hazard. CDOT does not currently possess the resources

necessary to provide comprehensive preventative mitigation against catastrophic rockslides with their current rockfall budget. Instead, CDOT deals with rockslide hazards with a more reactive approach, repairing the slope after events occur once outside funding becomes available (an example would be the U.S. 6 slide at mile marker 261.6 in the summer of 2005, where FEMA contributed funds to repair the slope). Therefore, sites are rated with attention given to their rockfall potential, not the potential for catastrophic slope failures.

Several sites were encountered during the field work for this project that could potentially fail catastrophically (Figure 2.30). These sites were often characterized by large volumes of material overlying discontinuities that daylight directly into the roadways below. In order to document these features, a comment on major rockslide potential was added to the RHRS in order to describe these types of slope conditions. In the event that CDOT does receive an adequate budget to deal with these types of slopes, they will have an initial idea of which sites pose a significant rockslide hazard.

2.6.2 Dominating Rockfall Mode

There were several sites encountered in which a slope possessed two different material types that posed a rockfall hazard, including both rock outcrops and block-in-matrix materials (Figure 2.31). In these situations, both materials were rated in the geology parameters, and the material that created the highest rockfall hazard to the roadway was used to determine the total hazard score. A remark was added in order to address these situations and make it clear which types of rockfall hazard were present.



Figure 2.30: Examples of conditions that could potentially lead to catastrophic rockslides onto Colorado highways. Top left Picture: U.S. 34 in Larimer County, note the large slabs overlying planar, daylighting discontinuities. Top right Picture: CO Highway 24 in El Paso County, note the large blocks overlying the seeping, clay-filled, daylighting discontinuities. Bottom left Picture: CO Highway 14, note the large blocks overlying daylighting discontinuities. Bottom right Picture: U.S. 6 in Clear Creek County, note the massive overhanging blocks overlying daylighting discontinuities.



Figure 2.31: Examples of slopes with two material types present, block-in-matrix plus rock outcrops. The Picture on the left was taken from I-70 in Clear Creek County. In this situation, the block-in-matrix materials posed the higher rockfall hazard, and was used to calculate the total hazard score. The Picture on the right was taken from CO Highway 72. The block-in-matrix materials also posed the higher hazard to this roadway.

2.6.3 Dominating Sight Distance

This remark was simply added to differentiate whether the available sight distance was horizontal or vertical. Horizontal sight distance is the case when a rock slope exists on a blind corner in the road. Vertical sight distance is the case when a crest in the roadway prevents a driver from seeing rocks that may be in the roadway on the opposite side.

2.6.4 Mitigation Effectiveness

Several of the sites that were rated had already been mitigated. CDOT requested that these sites be rated as if the mitigation were not present, and then add a comment on the effectiveness of the mitigation. A simple grading scale of A – F was employed, A meaning fully effective, and F meaning unsatisfactory mitigation. Examples are shown in Figures 2.32 – 2.36. In the event a slope received a mitigation score of C or worse, this site would likely be revisited by an engineer to evaluate if the slope could be repaired further.



Figure 2.32: Example of mitigation effectiveness graded as A: Picture was taken on CO Highway 24 in El Paso County. Mitigation consists of abundant rock bolts holding large rocks and slabs in place, and mesh which directs rockfall to toe of slope.



Figure 2.33: Example of mitigation effectiveness graded as B: Picture was taken on I-70 in Clear Creek County. Mitigation consists of mesh that directs rocks into the ditch.



Figure 2.34: Example of mitigation effectiveness graded as C: Picture was taken on CO 119 in Gilpin County. This mitigation consisted of mesh only. Western edge is not covered with mesh, and the mesh is torn by a large block. Blocks originating from top of slope can roll over mesh.



Figure 2.35: Example of mitigation effectiveness graded as D: Picture was taken on CO 14 in Larimer County. Mitigation consisted of mesh. The mesh is confined to only one section of the slope. Large blocks can easily dislodge and would likely tear the mesh from the slope.



Figure 2.36: Example of mitigation effectiveness graded as F: Pictures were taken on U.S. 6 in Jefferson County. This mitigation consisting of mesh and rock blots. The mesh is torn in some areas, and unstable blocks above the meshed zone can impact roadway. There were no bolts installed in upper 3/4 of cut slope, and there are abundant loose blocks in this portion of the slope. The bolts are also confined to eastern 1/4 of cut.

CHAPTER 3

METHODOLOGY: DATA ANALYSIS

3.1 Initial Data Screening

Once the 200 slopes were rated, all of the data from the rating sheets were tabulated onto an Excel spreadsheet (Appendix A). This data was then subset according to the geological characteristics controlling rockfall (crystalline slopes, sedimentary slopes, block-in-matrix slopes). These were subset further to distinguish between slopes where only a road cut was being rated versus the total slope beyond CDOT's right of way (e.g., crystalline cut slopes versus crystalline total slopes). There were only six block-in-matrix slopes in which the total slope was rated. Given that this was such a small subset, these were grouped with the block-in-matrix cut slopes for statistical analyses. Likewise, there were only 8 sedimentary slopes rated, so these were also not subdivided into cut and total slopes. In total, 106 crystalline cut slopes, 51 crystalline total slopes, 35 block-in-matrix slopes, and 8 sedimentary slopes were rated. The subset data for each slope type is available in Appendix B.

Summary tables were created for each hazard parameter within the modified RHRS, (i.e., tabulating the number of slope heights that scored 3, 9, 27, or 81 for crystalline cuts) (Appendix C). Minitab® Release 14 Statistical Software was then used to create a series of data screening plots for each slope type for all of the hazard parameters within the modified RHRS. Bar charts were created for each hazard parameter showing the percent distribution of each scoring category (Appendix D). An example is available in Figure 3.1.

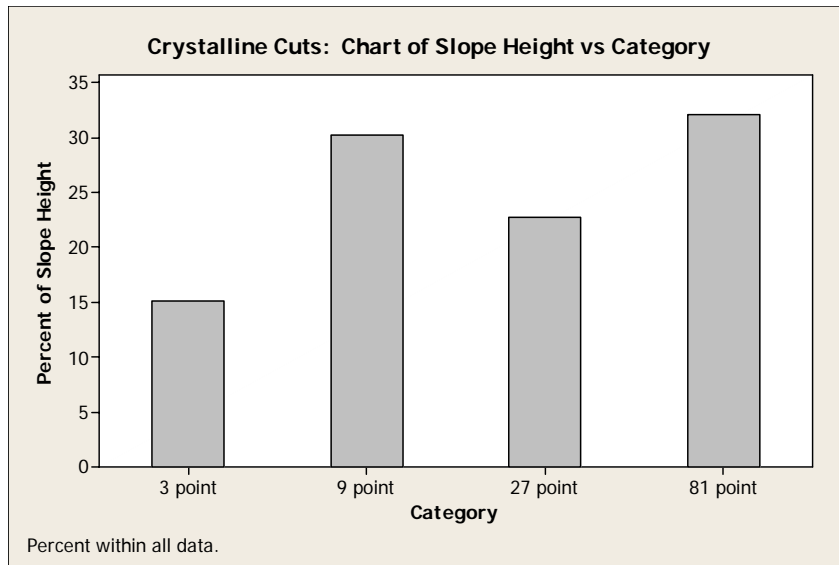

Figure 3.1: Bar chart showing the percent distribution of scores for the slope height hazard parameter for crystalline cut slopes. This reveals a wide distribution in the scores.

These bar charts were then analyzed in order to choose parameters that would be included for the statistical analyses to find parameters that influenced rockfall the most in the Colorado Front Range. Those parameters that were characterized by a wide distribution in the scoring (such as Figure 3.1) were chosen for the next step of data screening. Other parameters that did not have a wide distribution of scores (those that did not have at least two score categories with 15% or more of the distribution) were removed from further statistical analyses (Figure 3.2). Such scoring distribution implies that the variable being analyzed was the same at each site, and therefore does not help to describe how differences in each parameter control rockfall from site to site. In the future when additional slopes are rated beyond the Front Range within differing climate zones and geological environments, a wider scoring distribution will likely be generated for many of these parameters.

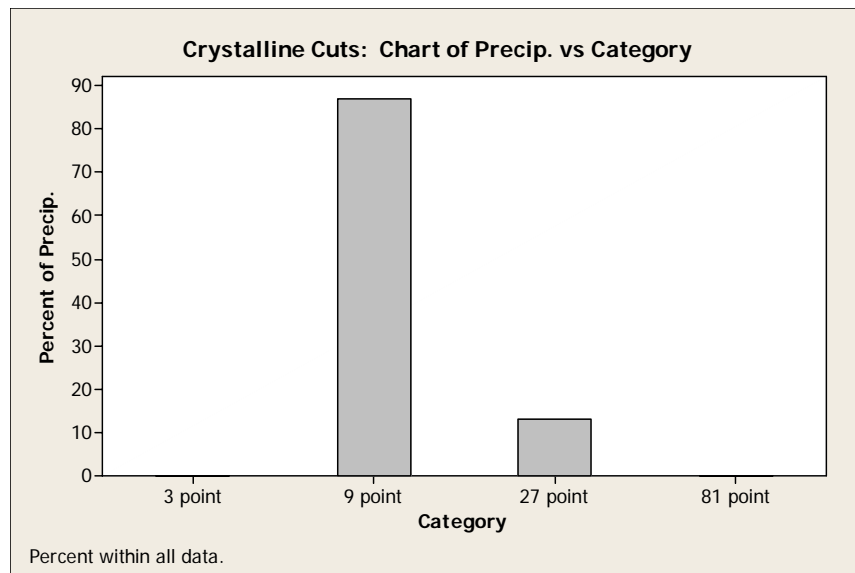

Figure 3.2: Bar chart showing the percent distribution of scores for the precipitation hazard parameter for crystalline cut slopes. This reveals a tight distribution of scores. The 27 point category had less than 15% of the total scoring distribution, and there were no slopes that had scores of 3 or 81. Therefore, this parameter was not included in further statistical analyses.

3.2 Least Squares Regressions

The next step was to determine which of the hazard parameters had a statistically significant influence on the total hazard score. Minitab was used to perform least squares regressions and to create linear fitted line plots between each hazard parameter and the total hazard scores. A 95% confidence interval and associated P value was used to determine which of these regressions was statistically significant ($P < 0.05$ implies a relationship that is statistically significant). R^2 values are also recorded to judge the goodness of fit of the regression trend lines. Figures 3.3 and 3.4 illustrate two such fitted line plots.

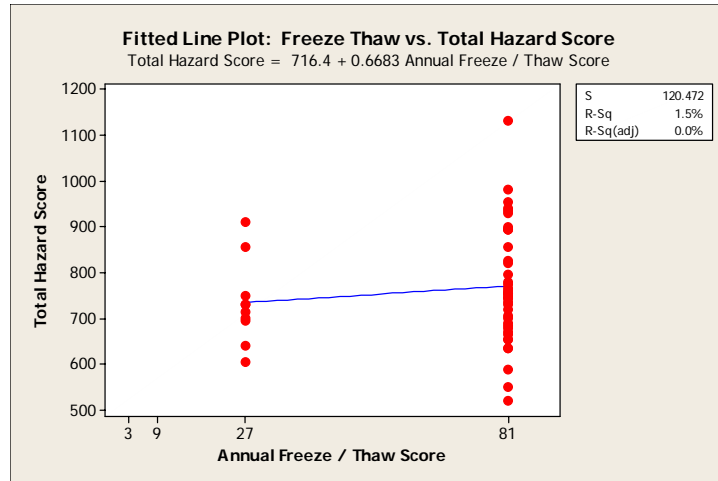

Figure 3.3: Fitted line plot for freeze thaw vs. total hazard score for crystalline total slopes. For this regression, $P = 0.400$, implying that the relationship was not statistically significant.

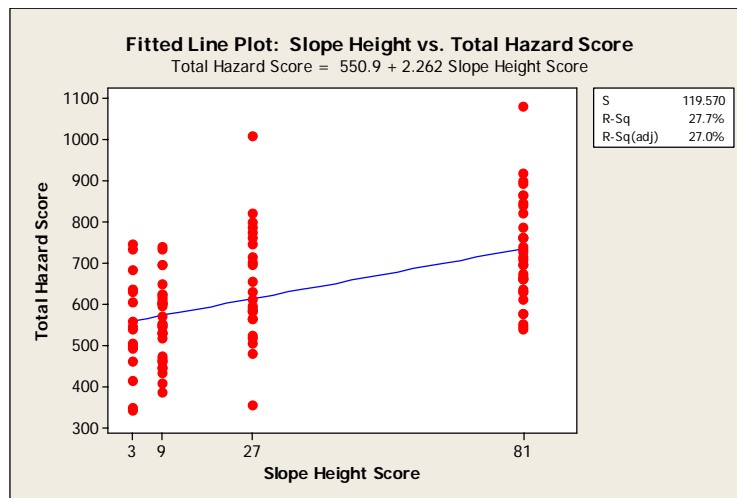

Figure 3.4: Fitted line plot for slope height vs. total hazard score for crystalline cut slopes. For this regression, $P = 0.000$, implying that the relationship was statistically significant.

Least squares regressions and fitted line plots were also produced for each parameter vs. the rockfall frequency score to determine if any of the hazard parameters had a statistically significant influence on the frequency of rockfall occurrence at a given site. As mentioned in Chapter 2, the scores for the rockfall frequency parameter were taken from CDOT's original RHRS for "observed history", which were based off of the maintenance reports that were obtained during drive-throughs when this system was originally created in 1992. Therefore this data may be out of date and the accuracy may be questionable. However, should this data be revised or validated in the future, this methodology could be used to reveal important correlations. Results for all of the least squares regressions and their associated fitted line plots are available in Appendix E.

Of the parameters that were analyzed for each slope type, those that showed a statistically significant influence on the total hazard score (P value < 0.05) were chosen for further statistical analysis. The goal was to be able to rank these parameters against one another to determine which had the most significant influence on the total hazard score.

3.3 Ordinal Logistic Regression

Logistic regression is typically used in the social sciences to model large multidimensional problems when many variables are measured and interactions between them are complex (Dillon & Goldstein, 1984). It has recently become a more popular tool to analyze geological processes such as landsliding and rockfall, given the large number of variables and complex interactions between them (Vandewater et al., 2005). Logistic regression allows simultaneous analysis of the effects that a number of variables have on a response variable by creating an interpretable mathematical model to account for all of the observations that were made (Dillon & Goldstein, 1984).

Ordinal logistic regression is a type of multinomial logistic regression designed to analyze multiple classes of response variables that are ranked with a specific ordering (i.e., high, medium, low, or none, some, severe) (Hosmer & Lemeshow, 2000). Often, a response variable may be represented by a continuous range of values and must be arranged arbitrarily into categories in order to perform a logistic regression (Dillon & Goldstein, 1984; Hosmer & Lemeshow, 2000).

Minitab can be used to perform logistic regression on an ordinal response variable. A mathematical model with multiple predictors (covariates) is fit using an iterative-reweighted least squares algorithm to obtain the most likely estimates of the parameters (McCullagh & Nelder, 1992). All of the hazard parameters from each slope type that revealed a statistically significant relationship with the total hazard score were chosen for input into an ordinal logistic regression to be performed by Minitab.

Because the response variable (total hazard score) was a continuous range of values, it was necessary to group it into at least 3 categories in order to run the regression. The total hazard scores from each slope type being analyzed were divided into 3 groups: high, medium, and low; which were coded 1, 2, and 3, respectively. The total hazard scores for each slope type were divided into the three categories so that each category had a similar number of slopes within it (Table 3.1). The order of the coding determines the signs of the coefficients for the variables obtained by software packages (Hosmer & Lemeshow, 2000). The coding of each slope type along with the individual parameters scored is available in Appendix B.

Table 3.1: Total hazard score divisions for each slope type.

<u>Crystalline Cut Slopes</u>			
Total Hazard Score Divisions	0 - 549	550 - 699	≥ 700
Rank	Low	Medium	High
Coding	3	2	1
Number of Slopes	31	44	31
<u>Crystalline Total Slopes</u>			
Total Hazard Score Divisions	0 - 699	700 - 799	≥ 800
Rank	Low	Medium	High
Coding	3	2	1
Number of Slopes	15	21	15
<u>Block-in-Matrix Slopes</u>			
Total Hazard Score Divisions	0 - 449	450 - 599	≥ 600
Rank	Low	Medium	High
Coding	3	2	1
Number of Slopes	10	14	11

The Minitab help file states that continuous predictors must be modeled as covariates, and categorical predictors must be modeled as factors. The scoring of all of the parameters within the RHRS is meant to be on a continuous scale (Pierson & VanVickle, 1993). Pierson & VanVickle (1993) even provide graphs and tables in order to interpolate between the usual scores of 3, 9, 27, and 81 for measurable parameters (i.e., ditch catchment or sight distance). Given that all of the parameters are meant to be rated on this continuous scale, all of the parameters that were inputted into the model were listed as covariates.

Minitab also provides several link functions to use to run the model. The logit link function was used, because it provides the simplest interpretation of the parameters inputted into the model. Use of this link function provides each parameter with a

coefficient and an associated odds ratio that can be used to rank the parameters against one another.

The coefficients for each parameter represent the estimated change in the log of $P(\text{event}) / P(\text{not event})$ for a one-unit change in a parameter's score, assuming the other parameters remain constant (Minitab v. 14). In other words, a coefficient for a parameter indicates the log odds of the probability of whether or not the total hazard score will increase from a category 3 (low) to a category 2 (medium), or a category 2 (medium) to a category 1 (high) given a one-unit increase in that parameter's score while all the other parameters within the model remain constant.

However, there was no interpolation between the scores of 3, 9, 27, and 81 when the 200 rock slopes were rated for this project. Therefore a one-unit increase would not reveal the effect of shifting from one scoring category to another (a one-unit increase would indicate a shift in score from a 3 to a 4, or from a 27 to a 28). Therefore, all of the scores for each parameter were coded 1, 2, 3, and 4 for 3, 9, 27, and 81, respectively. A one-unit increase now represents a shift from one scoring category to the next, and it can be observed what effect this shift has on the resulting total hazard category.

The odds ratios are simply computed by taking $e^{\text{Coefficient}}$ for each parameter. If the odds ratio \neq one, then a change in the parameter will produce a statistically significant change in the odds for the response (total hazard category) (Vandewater et al., 2005). For example, if the slope height parameter has an odds ratio of 5.00, then it is 5x more likely that the total hazard category will increase if the slope height score increases. The odds ratios for each parameter can be used to rank the parameters against one another to determine which has the most influence on the total hazard category.

Minitab also provides the option of displaying both the Pearson and Deviance goodness of fit tests. These tests imply whether the model created by the logistic regression fits the data or not. The null hypothesis is that the model fits the data. If the associated P values for these tests is greater than 0.05, then there is insufficient evidence to reject the null hypothesis; therefore the model fits the data. However, if the P values

are less than 0.05, the null hypothesis is rejected and the model created does not fit the data (Minitab v. 14). This option was chosen to estimate the validity of the models created by the logistic regression.

3.4 Multivariate Regression Analysis

After the least squares regression and the ordinal logistic regression were performed, statistically significant parameters from the logistic regression were analyzed using a backward elimination stepwise regression in Minitab with a 95% confidence interval. This was performed to obtain an equation to estimate the total hazard score for each of the slope types analyzed based on the scores of a few parameters instead of rating all 18 parameters (for both crystalline slope types) and all 12 parameters (for block-in-matrix slopes). The total hazard scores predicted from these equations for each slope type were then compared to the actual total hazard scores using a fitted line plot to gauge their accuracy and predictive ability.

3.5 Comparing the Two RHRS

It was also considered necessary to analyze the difference between CDOT's original RHRS and the modified version. The total hazard scores from the 200 slopes that were rated with the modified version were tabulated and ranked in an Excel spreadsheet alongside scores for the same slopes in the original RHRS. In addition, hazard scores were tabulated using CDOT's old RHRS without the risk parameters (AVR, sight distance, and number of accidents), and also ranked alongside the new total hazard scores for the 200 slopes that were rated. These tables are available in Appendix F. The rankings and scores were compared using simple descriptive statistics to ensure

that the modifications made to the system both improved the spread of the scores and better identified slopes that may be prone to rockfall.

CHAPTER 4

RESULTS

4.1 Least Squares Regressions

Tables 4.1 to 4.8 summarize the results for the least squares regressions that were performed in Minitab. Relationships that are statistically significant due to P values < 0.05 are in bold type.

Table 4.1: Regression results for crystalline cut slopes comparing each parameter to rockfall frequency (n = 106).

Crystalline Cut Slopes			
<u>Response (Y)</u>	<u>Predictor (X)</u>	<u>R² (%)</u>	<u>P value</u>
Rockfall Frequency	Slope Height	0.1	0.732
Rockfall Frequency	Launching Features	3.2	0.065
Rockfall Frequency	Ditch Catchment	1.0	0.319
Rockfall Frequency	Annual Freeze thaw	0.1	0.731
Rockfall Frequency	Seepage / Water	0.0	0.909
Rockfall Frequency	Slope Aspect	8.7	0.002
Rockfall Frequency	Rock Character	0.0	0.981
Rockfall Frequency	Overhang	1.7	0.184
Rockfall Frequency	Block Size / Volume	0.3	0.567
Rockfall Frequency	Persist. Orient.	0.2	0.651
Rockfall Frequency	Aperture	0.1	0.706
Rockfall Frequency	Disc. Weathering	0.5	0.466
Rockfall Frequency	Friction	1.9	0.159

Table 4.2: Regression results for crystalline cut slopes comparing each parameter to the total hazard score (n = 106).

Crystalline Cut Slopes			
<u>Response (Y)</u>	<u>Predictor (X)</u>	<u>R² (%)</u>	<u>P value</u>
Total Hazard	Slope Height	27.7	0.000
Total Hazard	Rockfall Frequency	14.0	0.000
Total Hazard	Launching Features	34.6	0.000
Total Hazard	Ditch Catchment	8.3	0.003
Total Hazard	Annual Freeze thaw	0.2	0.633
Total Hazard	Seepage / Water	8.0	0.003
Total Hazard	Slope Aspect	18.8	0.000
Total Hazard	Rock Character	14.1	0.000
Total Hazard	Overhang	32.9	0.000
Total Hazard	Block Size / Volume	27.5	0.000
Total Hazard	Persist. Orient.	24.3	0.000
Total Hazard	Aperture	18.2	0.000
Total Hazard	Disc. Weathering	18.0	0.000
Total Hazard	Friction	0.5	0.477

Table 4.3: Regression results for crystalline total slopes comparing each parameter to rockfall frequency (n = 51).

Crystalline Total Slopes			
<u>Response (Y)</u>	<u>Predictor (X)</u>	<u>R² (%)</u>	<u>P value</u>
Rockfall Frequency	Slope Angle	0.2	0.735
Rockfall Frequency	Launching Features	7.8	0.047
Rockfall Frequency	Annual Freeze thaw	1.4	0.402
Rockfall Frequency	Seepage / Water	0.0	0.885
Rockfall Frequency	Slope Aspect	1.4	0.405
Rockfall Frequency	Rock Character	1.5	0.392
Rockfall Frequency	Overhang	0.0	0.976
Rockfall Frequency	Block Size / Volume	3.2	0.211
Rockfall Frequency	Persist. Orient.	2.1	0.306
Rockfall Frequency	Aperture	3.6	0.181
Rockfall Frequency	Disc. Weathering	0.6	0.584
Rockfall Frequency	Friction	7.8	0.048

Table 4.4: Regression results for crystalline total slopes comparing each parameter to the total hazard score (n = 51).

Crystalline Total Slopes			
<u>Response (Y)</u>	<u>Predictor (X)</u>	<u>R² (%)</u>	<u>P value</u>
Total Hazard	Rockfall Frequency	9.5	0.028
Total Hazard	Slope Angle	8.1	0.043
Total Hazard	Launching Features	39.7	0.000
Total Hazard	Annual Freeze thaw	1.5	0.400
Total Hazard	Seepage / Water	1.0	0.475
Total Hazard	Slope Aspect	14.3	0.006
Total Hazard	Rock Character	14.4	0.006
Total Hazard	Overhang	37.8	0.000
Total Hazard	Block Size / Volume	24.2	0.000
Total Hazard	Persist. Orient.	31.3	0.000
Total Hazard	Aperture	4.3	0.143
Total Hazard	Disc. Weathering	18.9	0.001
Total Hazard	Friction	0.2	0.757

Table 4.5: Regression results for block-in-matrix slopes comparing each parameter to rockfall frequency (n = 35).

Block-in-Matrix Slopes			
<u>Response (Y)</u>	<u>Predictor (X)</u>	<u>R² (%)</u>	<u>P value</u>
Rockfall Frequency	Slope Height	0.2	0.789
Rockfall Frequency	Slope Angle	0.0	0.904
Rockfall Frequency	Launching Features	5.9	0.160
Rockfall Frequency	Ditch Catchment	5.0	0.198
Rockfall Frequency	Annual Precip.	1.0	0.573
Rockfall Frequency	Annual Freeze thaw	0.0	0.986
Rockfall Frequency	Slope Aspect	9.6	0.069
Rockfall Frequency	Block Size	4.8	0.204
Rockfall Frequency	Block Shape	0.1	0.831
Rockfall Frequency	Vegetation	0.1	0.830

Table 4.6: Regression results for block-in-matrix slopes comparing each parameter to the total hazard score (n = 35).

Block-in-Matrix Slopes			
<u>Response (Y)</u>	<u>Predictor (X)</u>	<u>R² (%)</u>	<u>P value</u>
Total Hazard	Slope Height	1.7	0.454
Total Hazard	Rockfall Frequency	9.7	0.069
Total Hazard	Slope Angle	5.6	0.170
Total Hazard	Launching Features	23.7	0.003
Total Hazard	Ditch Catchment	1.4	0.501
Total Hazard	Annual Precip.	2.7	0.343
Total Hazard	Annual Freeze thaw	13.4	0.030
Total Hazard	Slope Aspect	29.8	0.001
Total Hazard	Block Size	27.0	0.001
Total Hazard	Block Shape	7.1	0.121
Total Hazard	Vegetation	25.6	0.002

Table 4.7: Regression results for sedimentary slopes comparing each parameter to rockfall frequency (n = 8).

Sedimentary Slopes			
<u>Response (Y)</u>	<u>Predictor (X)</u>	<u>R² (%)</u>	<u>P value</u>
Rockfall Frequency	Slope Height	10.4	0.436
Rockfall Frequency	Slope Angle	57.6	0.029
Rockfall Frequency	Launching Features	10.2	0.440
Rockfall Frequency	Ditch Catchment	100.0	0.000
Rockfall Frequency	Annual Precip.	100.0	0.000
Rockfall Frequency	Seepage / Water	21.0	0.253
Rockfall Frequency	Slope Aspect	55.6	0.034
Rockfall Frequency	Under Cutting	21.8	0.244
Rockfall Frequency	Jar Slake	44.5	0.071
Rockfall Frequency	Block Size / Volume	2.2	0.725
Rockfall Frequency	Persist. Orient.	2.2	0.725
Rockfall Frequency	Disc. Weathering	69.2	0.010
Rockfall Frequency	Friction	0.9	0.822

Table 4.8: Regression results for sedimentary slopes comparing each parameter to the total hazard score (n = 8).

Sedimentary Slopes			
<u>Response (Y)</u>	<u>Predictor (X)</u>	<u>R² (%)</u>	<u>P value</u>
Total Hazard	Slope Height	36.6	0.112
Total Hazard	Rockfall Frequency	82.2	0.002
Total Hazard	Slope Angle	35.3	0.120
Total Hazard	Launching Features	23.9	0.219
Total Hazard	Ditch Catchment	82.2	0.002
Total Hazard	Annual Precip.	82.2	0.002
Total Hazard	Seepage / Water	1.1	0.806
Total Hazard	Slope Aspect	29.6	0.164
Total Hazard	Under Cutting	46.7	0.062
Total Hazard	Jar Slake	61.7	0.021
Total Hazard	Block Size / Volume	11.3	0.415
Total Hazard	Persist. Orient.	11.3	0.415
Total Hazard	Disc. Weathering	68.7	0.011
Total Hazard	Friction	0.4	0.822

Given that the sedimentary slopes had such a small sample size (only eight slopes), the accuracy of further statistical analyses was questioned. Initial data screening revealed relationships that would likely not be reproduced given a larger sample size; for example, the “perfect” relationship between ditch catchment and rockfall frequency indicated by an $R^2 = 100$. In addition, the small sample size produced other relationships with questionable results. For example, the total hazard score appears to decrease with increasing jar slake scores, which is intuitively incorrect. Literature sources demonstrate the opposite trend (Shakoor 2005; Senior, 1999). Because of these results, further statistical analyses were not conducted on the sedimentary slopes.

Of the remaining slope types, only three parameters revealed a relationship with the rockfall frequency score (slope aspect for crystalline cuts; launching features and discontinuity friction for crystalline total slopes). Because so few parameters showed a

relationship with the rockfall frequency, further statistical analyses were not conducted against the rockfall frequency parameter.

The regression results for both types of crystalline slopes and the block-in-matrix slopes reveal several statistically significant trends when their parameters are plotted against the total hazard score. These parameters were analyzed using ordinal logistic regressions for each slope type in order to rank their degree of influence on the total hazard category.

4.2 Ordinal Logistic Regression Results

The results from the logistic regression for each slope type are summarized in the following subsections. The logistic regression tables are provided, which display each parameter's coefficients, the standard error associated with the coefficients, and Z statistics and P values to represent whether or not each parameter's coefficient has a statistically significant effect on the total hazard score. Larger values of Z indicate a more significant relationship with the response. They are calculated by taking the coefficient divided by the standard error (the smaller the standard error, the more precise the estimated coefficient) (Minitab v. 14). P values < 0.05 indicate that a parameter and its associated coefficient have an influence on the total hazard score (Minitab v. 14). These tables also display the odds ratios and their associated 95% confidence intervals. Positive coefficients and odds ratios greater than one indicate that higher scores for each parameter within the model are associated with higher categories of total hazard scores. Both the Pearson and Deviance goodness of fit tests are also displayed to indicate whether the models created for each slope type fit their respective data.

4.2.1 Ordinal Logistic Regressions: Crystalline Cut Slopes

Table 4.9 summarizes the results for the ordinal logistic regression for the crystalline cut slopes. The parameters that have a statistically significant influence on the total hazard category based on P values < 0.05 have been listed at the top of the table in order according to their rank based on their odds ratios. Those parameters that did not have a statistically significant influence on the total hazard category due to P values > 0.05 are listed at the bottom of the logistic regression table.

Table 4.9: Ordinal Logistic Regression for Crystalline Cut Slopes

Logistic Regression Table:

<u>Predictor</u>	<u>Coef</u>	<u>SE Coef</u>	<u>Z</u>	<u>P</u>	<u>Odds Ratio</u>	<u>95% CI</u>	
						<u>Lower</u>	<u>Upper</u>
Aperture	3.210	0.925	3.47	0.001	24.78	4.04	151.87
Ditch Catchment	2.236	0.847	2.64	0.008	9.35	1.78	49.22
Rock Character	1.871	0.546	3.43	0.001	6.50	2.23	18.94
Persist. Orient.	1.851	0.417	4.44	0.000	6.37	2.81	14.41
Slope Height	1.784	0.453	3.93	0.000	5.95	2.45	14.49
Launching Features	1.639	0.673	2.43	0.015	5.15	1.38	19.27
Slope Aspect	1.440	0.407	3.54	0.000	4.22	1.90	9.36
Rockfall Frequency	1.280	0.467	2.74	0.006	3.60	1.44	8.98
Seepage/ Water	0.986	0.522	1.89	0.059	2.68	0.96	7.45
Overhang	0.327	0.550	0.59	0.552	1.39	0.47	4.08
Block size / volume	1.273	0.689	1.85	0.065	3.57	0.93	13.80
Disc. Weathering	0.664	0.658	1.01	0.313	1.94	0.53	7.06

Goodness-of-Fit Tests:

<u>Method</u>	<u>Chi-Square</u>	<u>DF</u>	<u>P</u>
Pearson	99.7693	196	1.000
Deviance	73.6415	196	1.000

The odds ratios for each parameter are all positive and greater than one, indicating that an increase in each parameter's score has a direct effect on which category the total hazard score belongs to. For example, discontinuity aperture has by far the most influence on the category that the total hazard score will fall under compared to the other parameters. An increase in the joint aperture score (from a 3 to a 9, or from a 27 to an 81) makes it almost 25 times more likely that the total hazard category will increase (Hosmer & Lemeshow, 2000). Within the 95% confidence interval, the chance of increasing the category can be as low as 4.04 times or as high as 151.87 times.

Both the Pearson and Deviance goodness of fit tests gave P values equal to one. This indicates that there is insufficient evidence to reject the null hypothesis, therefore the model that was created by the logistic regression can be assumed to fit the data. Given that the P values are at their maximum value, the model created can be assumed to fit exceptionally well.

4.2.2 Ordinal Logistic Regressions: Crystalline Total Slopes

Table 4.10 summarizes the results for the ordinal logistic regression for the crystalline total slopes. The statistically significant parameters have been listed at the top of the logistic regression table in order based on their odds ratios, and the insignificant parameters are listed at the bottom.

Table 4.10: Ordinal Logistic Regression for Crystalline Total Slopes

Logistic Regression Table:

<u>Predictor</u>	<u>Coef</u>	<u>SE Coef</u>	<u>Z</u>	<u>P</u>	<u>Odds Ratio</u>	<u>95% CI</u>	
						<u>Lower</u>	<u>Upper</u>
Launching Features	4.516	1.613	2.80	0.005	91.45	3.87	2159.79
Block size / volume	2.941	1.313	2.24	0.025	18.94	1.44	248.41
Persist. Orientation	2.571	1.029	2.50	0.012	13.07	1.74	98.23
Slope Angle	2.400	0.942	2.55	0.011	11.02	1.74	69.87
Overhang	1.702	0.841	2.02	0.043	5.49	1.05	28.54
Rockfall Frequency	1.079	0.786	1.37	0.170	2.94	0.63	13.72
Slope Aspect	0.877	0.587	1.49	0.135	2.40	0.76	7.59
Rock Character	2.619	1.376	1.90	0.057	13.72	0.92	203.63
Disc. Weathering	1.084	1.303	0.83	0.406	2.96	0.23	38.01

Goodness-of-Fit Tests:

<u>Method</u>	<u>Chi-Square</u>	<u>DF</u>	<u>P</u>
Pearson	28.6755	89	1.000
Deviance	28.5314	89	1.000

Similar to crystalline cut slopes, the odds ratios are all positive and greater than one, which indicates that higher scores for each parameter will result in higher total hazard categories. Launching features has the most influence on determining the total hazard category compared to the other parameters. An odds ratio of 91.45 seems quite high, however within the 95% confidence interval, this ratio can be as low as 3.87, or even as high as 2160. This parameter was ranked so high simply because its scoring divisions almost perfectly match the divisions in the total hazard categories for crystalline total slopes. Slopes within category one all have launching features scores of 9 and 27, with the exception of two slopes that scored an 81. Slopes within category two all have launching features scores of 27 and 81, with the exception of one slope with a score of 9. All of the category 3 slopes have launching features scores of 81. Therefore, this

parameter matched the total hazard category far better than the other statistically significant parameters.

Similar to crystalline cut slopes, both the Pearson and Deviance goodness of fit tests gave P values equal to one. The model that was created by the logistic regression for crystalline total slopes also appears to fit the data extremely well.

4.2.3 Ordinal Logistic Regressions: Block-in-Matrix Slopes

Table 4.11 summarizes the results for the ordinal logistic regression for the block-in-matrix slopes. The parameters in the logistic regression table have been listed in the same manner as the crystalline slopes.

Table 4.11: Ordinal Logistic Regression for Block-in-Matrix Slopes

Logistic Regression Table:

<u>Predictor</u>	<u>Coef</u>	<u>SE Coef</u>	<u>Z</u>	<u>P</u>	<u>Odds Ratio</u>	<u>95% CI</u>	
						<u>Lower</u>	<u>Upper</u>
Block Size	1.766	0.824	2.14	0.032	5.85	1.16	29.40
Vegetation	1.416	0.535	2.65	0.008	4.12	1.45	11.75
Slope Aspect	1.162	0.446	2.61	0.009	3.20	1.33	7.66
Launching Features	-0.140	0.673	-0.21	0.835	0.87	0.23	3.25
Freeze thaw	1.021	0.824	1.24	0.215	2.78	0.55	13.94

Goodness-of-Fit Tests:

<u>Method</u>	<u>Chi-Square</u>	<u>DF</u>	<u>P</u>
Pearson	43.6675	55	0.864
Deviance	44.7216	55	0.837

The odds ratios are all positive and greater than one, which indicates that higher scores for each parameter will result in higher total hazard categories. The Pearson and Deviance goodness of fit tests gave values of 0.864 and 0.837, respectively. These values are greater than 0.05, therefore the model that was created by the logistic regression for block-in-matrix slopes can be assumed to fit the data. Given that these values do not equal one, it can be argued that the models created for both crystalline slopes fit their data slightly better than the block-in-matrix model fits its data set.

4.3 Summary of Results

Table 4.12 summarizes the results from both the logistic regression and the least squares regression performed on all of the parameters for the slope types that were analyzed in this study. Each parameter is ranked according to its ability to predict the total hazard score based on their R^2 values. Better R^2 values indicate a better fit for the regression equation. They are also ranked on their ability to predict the total hazard categories based on their odds ratios. Higher odds ratios indicate a higher influence on the total hazard category. The parameters that were not analyzed due to tight scoring distributions are also listed on this table with an indication of whether or not they should still be considered significant for predicting rockfall potential for each slope type. These results are analyzed in the next chapter.

Table 4.12: Rank of each parameter based on both least squares regression and logistic regression.

Crystalline Cut Slopes			Crystalline Total Slopes			Block-in-Matrix Slopes		
Rating Parameter	Least Squares	Logistic Regression	Rating Parameter	Least Squares	Logistic Regression	Rating Parameter	Least Squares	Logistic Regression
Slope Height	3	5	Slope Height	-	-	Slope Height	+	+
Rockfall Frequency	11	8	Rockfall Frequency	8	+	Rockfall Frequency	+	+
Average Slope Angle	-	-	Average Slope Angle	9	4	Average Slope Angle	+	+
Launching Features	1	6	Launching Features	1	1	Launching Features	4	+
Ditch Catchment	12	2	Ditch Catchment	-	-	Ditch Catchment	+	+
Annual Precipitation	+	+	Annual Precipitation	+	+	Annual Precipitation	+	+
Freeze Thaw Cycles	+	+	Freeze Thaw Cycles	+	+	Freeze Thaw Cycles	5	+
Seepage / Water	12	+	Seepage / Water	+	+	Seepage / Water	+	+
Slope Aspect	6	7	Slope Aspect	7	+	Slope Aspect	1	3
Rock Character	10	3	Rock Character	6	+	Block Size	2	1
Degree of Overhang	2	+	Degree of Overhang	2	5	Block Shape	+	+
Rock Weathering	+	+	Rock Weathering	+	+	Vegetation	3	2
Block Size / Volume	4	+	Block Size / Volume	4	2			
Number of Sets	+	+	Number of Sets	+	+			
Persist. Orientation	5	4	Persist. Orientation	3	3			
Aperture	8	1	Aperture	+	+			
Disc. Weathering	9	+	Disc. Weathering	5	+			
Friction	+	+	Friction	+	+			

1, 2, 3... etc: Indicates the rank of each parameter within the particular regression. Rankings for least squares regressions are based on the R² value. Rankings for logistic regressions are based on the odds ratios.

+, - : Indicates whether or not a parameter may be significant for each slope type. Plus signs indicate that a parameter may be significant, but there was too little variation in the scores to analyze it. Minus signs indicate that a parameter may not be significant for the given slope type.

4.4 Multivariate Regression

The eight parameters considered statistically significant from the logistic regression for crystalline cut slopes (see Table 4.12) were analyzed using the stepwise regression. None of them were removed by the analysis, however it was considered excessive to include all eight parameters within a predictive equation. Manual removal of additional parameters caused the values of the total hazard scores to become too spread out. Figure 4.1 shows how the total hazard scores predicted from the significant logistic regression parameters compared to the actual total hazard scores. The analysis of variance for this regression produced a P value equal to zero, indicating that this relationship is statistically significant.

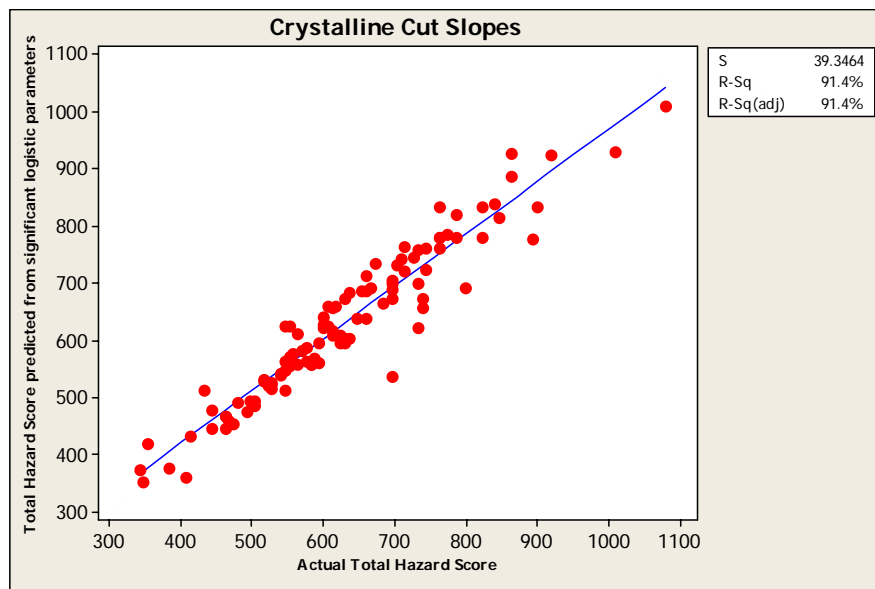

Figure 4.1: Fitted line plot comparing the actual total hazard scores of crystalline cut slopes to the total hazard scores predicted from the eight significant logistic regression parameters, $n = 106$.

Stepwise analysis of the five parameters for crystalline total slopes that were considered statistically significant using the logistic regression (see Table 4.12) resulted in the removal of block size/ volume from the predictive equation. The remaining parameters can be used to estimate the total hazard score based on equation 4.1.

Equation 4.1

$$\text{Total Hazard Score} = 472.1 + 1.41(\text{SA}) + 1.95(\text{LF}) + 1.39(\text{OH}) + 1.33(\text{PO})$$

SA = Slope Angle score

LF = Launching Features score

OH = Overhang score

PO = Persistence / Orientation score

Figure 4.2 shows the total hazard scores predicted from these four parameters compared to the actual total hazard scores. The analysis of variance for this regression also produced a P value equal to zero, indicating that this relationship is statistically significant.

The stepwise analysis was also performed on the three parameters for block-in-matrix slopes that were considered statistically significant using the logistic regression (see Table 4.12). None of these parameters were removed by this analysis, and they can be used to estimate the total hazard score based on equation 4.2.

Equation 4.2

$$\text{Total Hazard Score} = 269.1 + 1.99(\text{SA}) + 2.02(\text{BS}) + 0.73(\text{VG})$$

SA = Slope Aspect score

BS = Block Size / Volume score

VG = Vegetation score

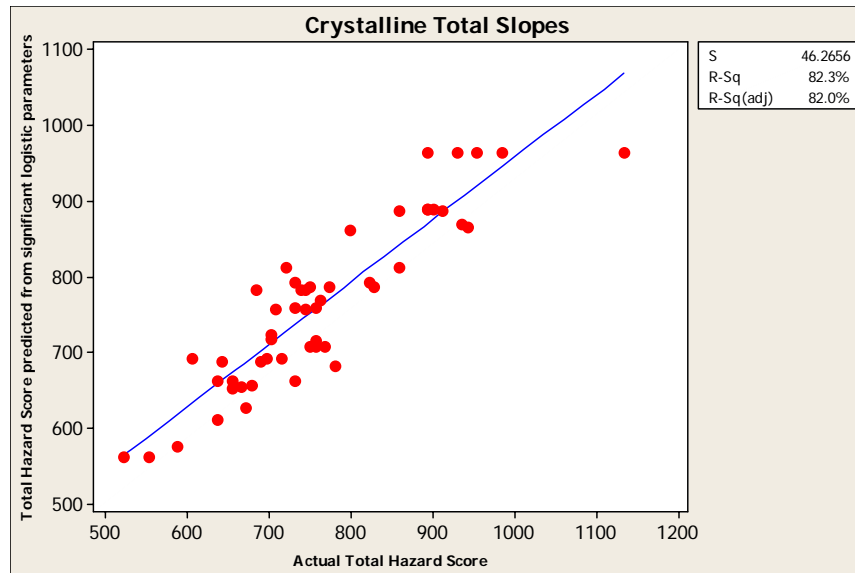

Figure 4.2: Fitted line plot comparing the actual total hazard scores of crystalline total slopes to the total hazard scores predicted from four significant logistic regression parameters, $n = 51$.

Figure 4.3 shows the total hazard scores predicted from these three parameters compared to the actual total hazard scores. The analysis of variance for this regression produced a P value equal to zero, indicating that this relationship is statistically significant.

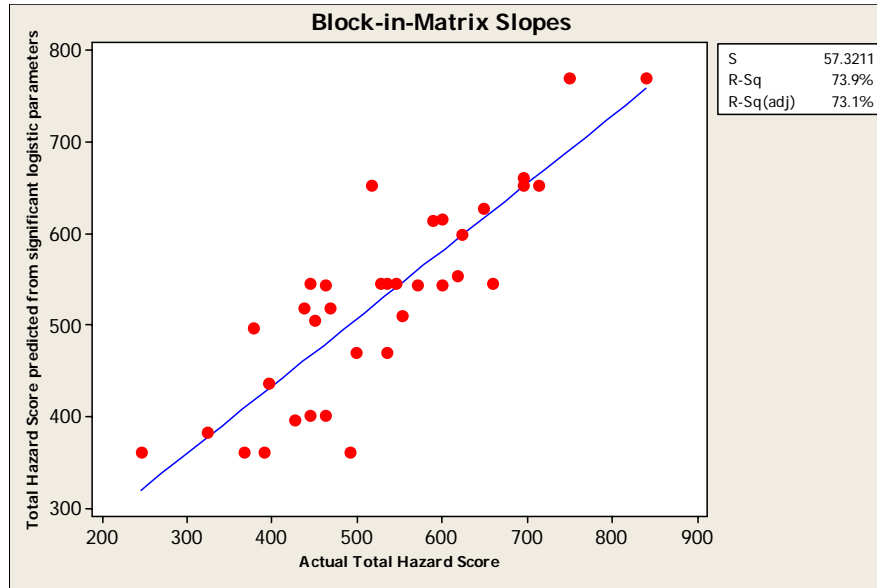

Figure 4.3: Fitted line plot comparing the actual total hazard scores of block-in-matrix slopes to the total hazard scores predicted from the three significant logistic regression parameters, $n = 35$.

4.5 Comparison of the Two RHRS

Comparing the rankings of the total hazard scores for the 200 slopes that were rated shows no relationship between the two systems. The modified version ranks the slopes completely different from CDOT's original total scores. The modified version also ranks the slopes completely different from CDOT's original scores when only the hazard parameters are tallied. This dramatic difference is caused by the emphasis on the climatic and geologic parameters in the new system. Figure 4.4 shows two scatter plots created comparing the ranking of the old total scores vs. the new total hazard scores using the modified version, and comparing the old scores obtained from only hazard parameters

vs. the new total hazard scores. It can be seen from this figure that the two systems do not relate to each other.

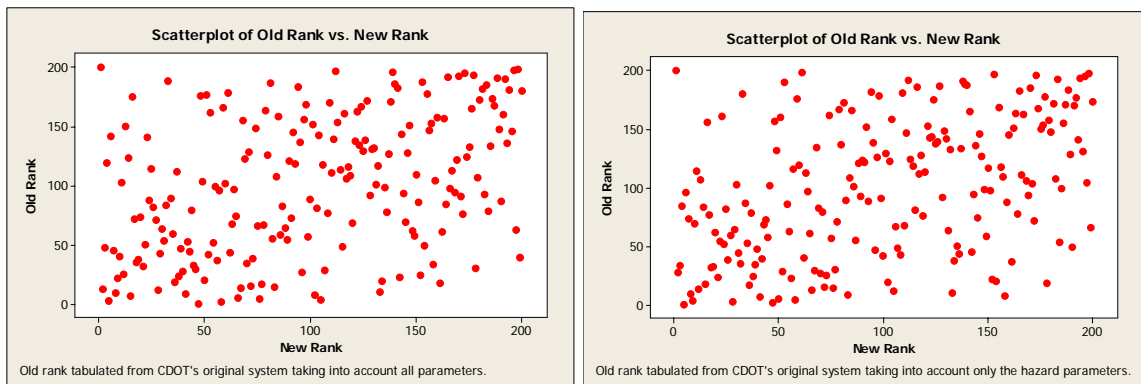

Figure 4.4: Scatter plot illustrating the differences in scoring ranks between the old RHRS and the modified RHRS for the 200 slopes that were rated for this study.

In addition, the modified RHRS provides a wider spread in the scoring distribution versus the original (Figure 4.5), resulting from the addition of parameters to the system. This allows for a better separation of slopes that have a low rockfall hazard versus those with a high rockfall hazard.

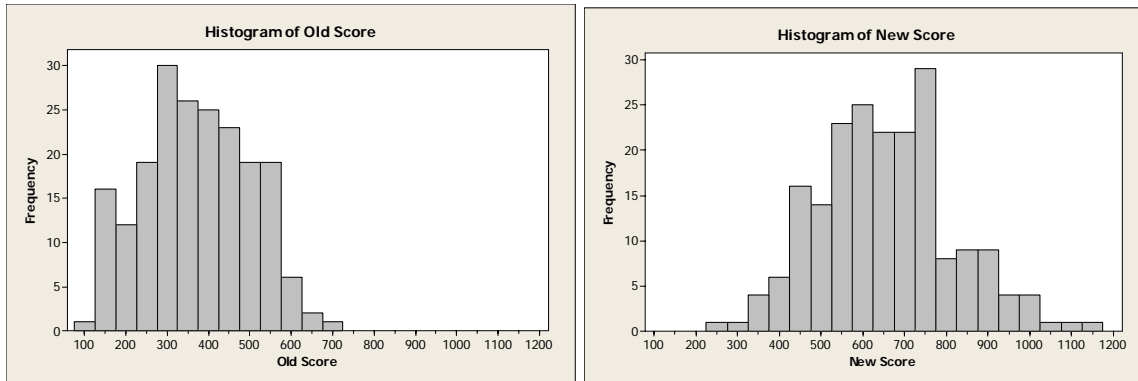

Figure 4.5: Histograms showing the distribution of total hazard scores for CDOT's original RHRS vs. the modified RHRS. The old scores were taken from CDOT's original system taking into account all parameters.

CHAPTER 5

DISCUSSION

5.1 Logistic Regression Versus Least Squares Regression

From Table 4.12, a question arises from ranking the hazard parameters based on the odds ratios from the logistic regression versus ranking them based on their R^2 values from the least squares regression. These two methods of analysis ranked the parameters in a different order. The logistic regression also calculated some parameters to not have a statistically significant influence on the total hazard category, even though they exhibited a relationship with the total hazard score with the least squares regressions.

The reason for this discrepancy is that the logistic regression compared each parameter to categories of total hazard scores. Therefore, if divisions in a parameter's scoring happened to fit the divisions in the total hazard categories better than any of the other parameters, this parameter was ranked higher in the logistic regression. The same is true for those parameters that do not have a statistically significant influence on the total hazard category, even though they were initially considered to have a statistically significant influence on the total hazard score based on the initial least squares regressions. The divisions in their scores are such that they cannot be used to predict the total hazard category. In addition, the logistic regression is a multivariate analysis, and it takes into account the influence of all of the parameters at once. This also affects the order in which they become ranked.

If a parameter did have a significant effect on the total hazard score with the least squares regression, but not the logistic regression, it still indicates that it can be used to predict degrees of slope instability. Perhaps if additional total hazard categories were

used, or if the categories had been divided up differently, it is possible that the results from the logistic regression may have matched the rankings from the linear least squares regression better.

There are also parameters that did not show a statistically significant relationship with the total hazard score, or had scoring distributions such that they were not analyzed. This does not indicate that they do not have an effect on rock slope stability. One of the main reasons for tight scoring distributions was due to the geographic distribution of the rock slopes that were rated. The majority of the slopes rated for this project were within the Front Range, which is dominated by similar climates. The Front Range is also composed of mostly Precambrian granite and gneiss; therefore some of the geological characteristics did not vary much either.

5.2 Limitations due to Geographic Distribution

Annual precipitation, freeze thaw cycles, and seepage / water are parameters that were not found to correlate with the total hazard scores for any of the slope types due to the geographic distribution of the slopes that were rated. The three of these parameters are inherently related to one another. Their true effects would likely be observed if additional slopes were rated within a variety of climate regions.

Figures 2.8 and 2.9 show the distribution of precipitation and moist freeze thaw cycles for Colorado, and all 200 slopes that were rated fell into only two categories of each. This makes it impossible to quantify the effects of precipitation and freeze thaw on rockfall.

In addition, the scale of the figures that were used to score both of these parameters introduces significant error into the scoring procedure. Moist freeze thaw cycles may vary considerably from one slope to another, simply due to the ground water and seepage conditions, but the figure used to rate this parameter does not provide this

level of detail. Precipitation may also vary considerably from site to site, especially given the random distribution of cloud bursts throughout the summer months along the Front Range. Again, this level of detail is not available from the figure that was used to score this parameter.

There was also error when rating the seepage / water parameter due to geographic constraints as well. It was mentioned previously that all 200 slopes were rated during the summer months, which are typically dry in Colorado. All of the block-in-matrix slopes were dry and rated as such, and very few crystalline slopes were experiencing active seepage. The degree of seepage therefore had to be estimated based on the presence of seepage stains within the rock mass. There was not a wide distribution in the scores resulting from this methodology. The most severe seepage likely occurs during the spring snow melt, and slopes should be observed at this time in order to more accurately assess the effects this parameter has on rockfall.

Although these parameters were not found to correlate with the total hazard scores in this study, they should not be removed from the rating system. Technical literature emphasizes their importance on rockfall processes. For rock slopes, precipitation induces seepage within the rock mass, and provides moisture required for moist freeze thaw cycles to take place. These parameters have a combined effect of increasing pore pressures, reducing shear strength along discontinuities, and forcing discontinuities open within a rock slope.

For block-in-matrix slopes, the amount of precipitation is probably the most important factor controlling erosion rates of the matrix materials, and freeze thaw cycles are a factor in dislodging blocks within the material. Large blocks have a greater thermal conductivity than the surrounding soils, therefore if ground water is present, ice will form around and beneath the stones. Ice will continue to be added to the base of the stones due to ground water migrating towards it from unfrozen ground beneath. This continual addition of ice to the base of stones causes them to be heaved upward through the sediment, eventually exposing them to erosion and raveling. Once the ice thaws, the

stones do not return to their original position because surrounding fine grained sediment fills the area beneath the stones. This process is known as up-freezing or frost push (Corte, 1966; Easterbrook, 1999).

5.3 Limitations Due to Geological Homogeneity

The intact rock weathering grade, number of discontinuity sets, and friction along discontinuity surfaces are parameters that also did not correlate with the total hazard scores due to the fact that most of the slopes were rated within Precambrian granite and gneiss. If additional slopes were rated within a variety of geological environments, these parameters would likely show a stronger correlation with the degree of hazard present. These parameters should also be retained in the rating system, as technical literature supports their influence on rock slope stability.

The joint aperture category was not found to correlate with the total hazard score on crystalline total slopes because of the distribution in its scores: over 80% of the slopes scored an 81. However this parameter was ranked the most important for crystalline cut slopes. Discontinuity aperture is expected to be more variable in cut slopes given that these slopes have not been exposed to mechanical and chemical weathering processes for nearly as long as natural outcrops have. Therefore it makes sense that discontinuity aperture would have more of an influence on man made cuts than natural outcrops. The similarity of aperture in the total slopes made it impossible to discern the effects this parameter has on rockfall for these slope types.

The block shape for block-in-matrix slopes is another parameter that may have a significant influence on the degree of hazard present, but was not found to be statistically significant. This was due to both the small sample size (only 35 slopes), and the distribution of the scores for the slopes that were rated. Less than 15% of the slopes had scores of 3 or 81. Because there were so few slopes encountered that had tabular shaped

blocks or perfectly rounded blocks, it is not possible to determine the influence that this parameter has on these slope types.

5.4 Parameters Demonstrated to be Important

The results produced from the least squares regressions, the logistic regressions, and the stepwise multivariate regressions do support most of the additions that were made to the RHRS. Geologic and climatic parameters were added to the system because published scientific research has indicated that these factors do have an influence on rock slope stability. Higher hazard scores in effect represent more unstable slopes, therefore parameters that show a statistically significant relationship with those scores also indicate that their characteristics can be used to predict the degree of rock slope stability. The multivariate stepwise regression illustrated that total hazard scores for crystalline total slopes and for block-in-matrix slopes can be estimated by measuring only four and three parameters, respectively, for each slope type and using equations 4.1 and 4.2.

The parameters within this study that were found to have a statistically significant influence on the total hazard score indicate a correspondence between the parameter and the total score. A hazardous condition with one parameter therefore is often related to hazardous conditions for others, which causes the total hazard score to track with an individual parameter's score. Given that the logistic regression is a multivariate analysis, the ranking of each parameter takes into account the influence of the others that were included in the model. In addition, the total hazard scores estimated from the significant logistic regression parameters for all of the slope types using the stepwise regression compared well with the actual total hazard scores. This gives additional support for their predictive ability. Therefore, highly ranked parameters in the logistic regression will be considered of primary importance in the discussion below.

5.4.1 Crystalline Cut Slopes

When all of the significant variables were considered collectively in the ordinal logistic regression, discontinuity aperture was found to have the most influence on the category of the total hazard score. Therefore, several other parameters must also vary in synch with joint aperture. Moist freeze thaw cycles probably have the most influence on forcing discontinuities open within a rock mass. Therefore, several slopes that have open discontinuities are likely south facing slopes, thus have a high slope aspect score as well. If these slopes are experiencing freeze thaw processes, then they may also experience active seepage during spring snow melt, which would leave seepage stains on the rock mass. Discontinuities that have a wide aperture may also have a high persistence. Higher aperture also increases the exposure of the discontinuity surfaces to both physical and chemical weathering; therefore, both the weathering grade and the friction may degrade as aperture increases. Open discontinuities also lead to the presence of numerous unstable blocks within a given slope, which would increase the score for the volume of material expected to fail, and could also increase the rockfall frequency at a given site.

The ditch catchment had the second highest influence on the total hazard category. Intuitively, several parameters should be related and likely track with this score as well. Slope height is the most obvious relationship, as higher slopes require both wider and deeper catchment areas. And as slope height increases, the degree of launching features present may also increase. Slopes with a launching features score of 81 automatically received a score of 81 for the ditch catchment as well. The slope angle is also related to the required ditch design, however, this parameter was not considered important for this slope type because the cut slopes are mostly designed at similar angles.

The rock character was ranked third by the logistic regression. High scores in this parameter indicate that the rock mass is composed of zones of material that are highly susceptible to weathering. This condition may result in the formation of overhangs of more resistant material; therefore these scores may track with one another at some sites.

In addition, different degrees of weathering grades will result in a highly irregular slope face, which would drive the launching features score up. The presence of mica schist / shear zones / pegmatites also may have an influence on the weathering grades of adjacent discontinuities, as they are likely to be infilled with the weathering product as these zones degrade.

5.4.2 Crystalline Total Slopes

The launching features parameter was ranked as having the most influence on the total hazard score for both types of regression. Therefore several of the parameters tend to track with launching features. Slope height is an obvious parameter; higher slopes have more surface area, making it more likely to have surface irregularity and launching features. As mentioned before, higher slopes require wider and deeper ditches. The rock character could enhance launching features because differential weathering will result in surface irregularity within a slope. The rockfall frequency at a given site may also be more of a problem with higher degrees of launching features, as rocks are more likely to end up in the roadway.

The block size / volume of material parameter was ranked second with the logistic regression. The degree of overhang may increase with this parameter at some sites, as larger blocks are required to create large overhanging features. The volume of material can also be related to the orientation of discontinuities, which was ranked third. Daylighting discontinuities are one of the factors considered for the potential of catastrophic rockslides, and the volume of material expected to fail would be higher for these slopes than for those with a favorable discontinuity orientation.

5.4.3 Block-in-Matrix Slopes

The most important parameters for predicting the rockfall hazard for block-in-matrix slopes, in order, were block size, vegetation, and slope aspect. Most of the other parameters can be intuitively related to these parameters, explaining why the total hazard score tracks with their individual scores.

The block size may have an influence on the launching features score for some slopes. Larger blocks present within the slope create more surface irregularity, which could have the effect of launching smaller blocks into the roadway. In addition, larger blocks may also increase the score for the rockfall frequency at some sites, as larger blocks possess more kinetic energy, which makes them more likely to end up in the roadway if they dislodge.

The vegetation and slope aspect parameters are both related to one another. Branson (1990) concluded that due to the increased solar radiation that south slopes experience during the year, it is more difficult for vegetation to establish itself. These two parameters also likely affect the rockfall frequency at some sites. If a slope has little vegetation established, severe storms will be able to erode the matrix materials much faster and increase the likelihood for rockfall. In addition, south facing slopes will experience more freeze thaw cycles, and if ground water is present due to high precipitation amounts in an area, blocks are more likely to experience frost push on these slopes (Corte, 1966; Easterbrook, 1999).

5.5 Analysis

Both the univariate least squares regression and the multivariate ordinal logistic regression indicated that several parameters had a statistically significant influence over

the total hazard scores for each slope type. Those parameters that ranked high with the ordinal logistic regression could possibly be used to predict scores for other parameters that are intuitively related. However, these relationships may not be true for every slope that was rated. It must be kept in mind that all of these parameters interact with one another to varying degrees in a complex manner, which may vary from location to location.

For example, the relationships that were proposed to exist between joint aperture and the other parameters listed for crystalline cut slopes do not necessarily indicate that every time a slope contains open discontinuities, it must be a south facing slope, or it must have abundant seepage, etc. One slope may have a high degree of aperture, which may result from seepage and freeze thaw processes on a south facing slope. Another site may have a north facing slope and may not experience as many freeze thaw cycles or abundant seepage, but the rock may be more susceptible to weathering, creating high degrees of both aperture and discontinuity weathering. Therefore, it should not be expected that all of the parameters listed will exhibit a relationship when compared to the discontinuity aperture individually for all of the crystalline cut slopes. This is true for the other parameter relationships mentioned for the crystalline total slopes, and for the block-in-matrix slopes.

To prove this point, the scores for those parameters that intuitively have a relationship with discontinuity aperture for crystalline cut slopes (listed above) were compared to the aperture scores themselves using least squares regression in Minitab. Only the block size / volume parameter showed a statistically significant relationship, while all of the others did not. This emphasizes the point that the parameters are interacting in a complex manner and their relationships with one another vary from site to site.

Therefore, equations 4.1 and 4.2 that were produced to estimate total hazard scores for crystalline total slopes and block-in-matrix slopes should be used with caution. These equations are only applicable in the geographic and geologic confines of the Front

Range, and the actual total hazard score may not always be predicted accurately from using them. A predictive equation could not be developed for the crystalline cut slopes using only a few parameters, because the more parameters that were removed from the stepwise regression, the more spread out and inaccurate the scores became. It should be noted that the crystalline cut slopes represented a much larger sample size ($n = 109$) than both crystalline total slopes ($n = 51$) and block-in-matrix slopes ($n = 35$). Therefore, if additional crystalline total slopes and block-in-matrix slopes were rated within the Front Range, it is likely that additional parameters would also be required to produce an equation to accurately predict their total hazard scores.

5.6 Comparison of the two RHRS

The distribution of scores for the new RHRS illustrates that slopes with a high rockfall hazard tend to stand out more and are more easily identified compared to the original system. The original system tended to lump slopes together simply because it did not have as many parameters available to create a wide distribution of scores. Therefore, the addition of parameters to the RHRS should increase CDOT's ability to identify slopes that are the most prone to rockfall due to adverse geologic and climatic conditions. In addition, the replacement of subjective terminology with numerical values or more descriptive parameters should allow for more consistency when rating different slopes, or when different raters are using the system.

CHAPTER 6

CONCLUSIONS AND RECOMMENDATIONS

6.1 Conclusions

The statistical analyses performed for this study accomplished the initial goals: The dominating factors controlling rock slope stability in the Colorado Front Range have been identified and ranked, and they can be used to intuitively rank some of the other parameters within the RHRS and to predict rockfall potential within the Front Range. Predictive equations to estimate the total hazard scores have been developed for crystalline total slopes and for block-in-matrix slopes using these dominating parameters. However, even with these equations, engineering experience is still required in order to assess the degree of rock slope instability and to judge the degree of interaction between various parameters at a given slope. Finally, comparison of the rankings of the 200 slopes that were rated has illustrated that the modifications made to CDOT's RHRS create a wider separation in scores allowing easier identification of slopes with a high degree of rockfall hazard present.

- Within the geographic and geologic confines of the Colorado Front Range, the following parameters have the most influence on rockfall hazard for crystalline cut slopes (ranked in this order): discontinuity aperture, ditch catchment, and rock character. The following parameters have the most influence on rockfall hazard for crystalline total slopes (ranked in this order): launching features, block size / volume of material, discontinuity persistence and orientation. The following parameters have the most influence on rockfall hazard for block-in-

matrix slopes (ranked in this order): block size / volume of material, vegetation, and slope aspect. Most of the remaining parameters for each slope type can be assessed by judging the dominating interactions present at a given site.

- There were not enough sedimentary slopes rated in this study to perform statistical analyses to assess the effects of the parameters that were added to this category of slopes.
- Although other parameters that were introduced to CDOT's RHRS did not have a statistically significant influence on rockfall hazard for this study, it does not indicate that they cannot be used to predict the degree of hazard present at a given site. The geologic and geographic confines of this study had a large effect on the scoring distribution for many climatic and geologic parameters that were added to the RHRS, therefore these parameters may still be important for assessing rockfall hazard. These parameters include annual precipitation, freeze thaw cycles, seepage / presence of water, rock weathering, number of discontinuity sets, friction along discontinuity surfaces, joint aperture for natural slopes, and block shape for block-in-matrix slopes.
- Rating of all slopes within CDOT's RHRS database would provide a much wider distribution of slopes within various geologic and geographic environments. This would give a chance to see the effects that the geologic and climatic parameters have on rockfall hazard on a statewide scale. Potentially, several parameters that were deemed insignificant in this study would show a significant relationship with the degree of rockfall hazard present.

- The additional parameters that were added to CDOT's RHRS allowed for a wider distribution of hazard scores, and allowed for a better identification of slopes that possess a high degree of rockfall hazard. Given that the additional parameters address several climatic and geologic factors that are widely recognized in literature to contribute to rockfall, the new total hazard scores are presumed to give a more accurate indication of the degree of instability and likelihood for rockfall.

6.2 Recommendations

Given that CDOT has a limited annual budget to deal with statewide rockfall problems, these recommendations should be considered as both time and funding become available:

- CDOT should replace their RHRS with the modified version, and rate the remaining slopes within their database. If feasible, mitigation should be employed on slopes with the highest total hazard scores taking into account either the average daily traffic, or the total risk score at each site so that hazardous slopes with the highest risk to the public are addressed first. Appendix G contains the new RHRS scoring sheet and all of the necessary figures that are required for CDOT to rate additional slopes.
- Once all of the slopes in Colorado have been rated, this statistical analysis should be conducted again. This would give a better idea of how each of the parameters affects rockfall within a variety of climates and geological materials. This would also allow for analysis of sedimentary slopes within Colorado.

- The data used to estimate the score for the rockfall frequency parameter is outdated. It would be useful for CDOT to conduct more drive-throughs with maintenance personnel using the criteria for this parameter to score rock slopes. This would give a more accurate and up to date representation for the frequency of rockfall at each site.
- The data used to estimate the number of accidents at each site is also inaccurate due to the method the State Highway Patrol uses to report these accidents. CDOT may wish to work with the State Highway Patrol in order to keep better track of accidents that are related to rockfall originating from rock slopes.
- Once CDOT has enough data on the rockfall frequency at a given site, and the number of accidents at a given site, it would be useful to statistically analyze the hazard parameters within the modified RHRS against both of these. This would give a better idea of which geologic and climatic factors actually contribute to the frequency of rockfall and the frequency of rockfall related accidents at a given site. CDOT could then direct mitigation efforts to minimize the severity of these parameters.

REFERENCES

- Anderson, S.A.; King, T.J.; Schloner M.; 1999. Urban rockfall hazard and mitigation cost rating, in: Amandei, B.; Kranz, R.L.; Scott, G.A.; Smeallie, P.H.; *Proceedings of the 37th U.S. Rock Mechanics Symposium, Volume 2, Rock Mechanics for Industry*, pp. 1229-1234.
- Andrew, R.D., 1994. *The Colorado Rockfall Hazard Rating System*, Colorado Dept. of Transportation, report # CTI-CDOT-2-94.
- Arndt, B.P.; Andrew, R.; Herring, K.; 2003. Rockfall potential along I-70 at the Georgetown Incline, in: Boyer, D.D.; Santi, P.M.; Rogers, W.P.; *Engineering Geology in Colorado: Contributions, Trends, and Case Histories, Association of Engineering Geologists Special Publication no. 15*.
- Arnold, J.G.; Allen, P.M.; Ramanarayanan, T.S.; Srinivasan, R.; Muttiah, R.S.; 1996. The geographical distribution of freeze/thaw and wet/dry cycles in the United States: *Environmental & Engineering Geoscience*, Vol. II, no. 4, pp. 596-603.
- Badger, T.C. & Lowell, S.M., 1992. Rockfall control in Washington State: *Transportation Research Record, National Research Council, Washington D.C.*, no. 1343, pp. 14-19.
- Barrett, R.K. & White, J.L., 1991, Rockfall prediction and control: *National Symposium on Highway and Railroad Slope Maintenance, 34th Annual Meeting of the Association of Engineering Geologists*, pp. 23-40.
- Barton, N.R., Lien, R., and Lunde, J., 1974. Engineering classification of rock masses for the design of tunnel support: *Rock Mechanics*, Vol. 6, no 4, pp. 189-239.
- Bateman, V., 2003. The development of a database to manage rockfall hazard: The Tennessee Rockfall Hazard Database: *2003 Transportation Research Board Annual Meeting*, 13p.
- Bieniawski, Z.T., 1989. *Engineering rock mass classifications: a complete manual for engineers and geologists in mining, civil, and petroleum engineering*, Wiley: New York.

- Branson, F.A., 1990. *Contrasts of vegetation, soils, microclimates, and geomorphic processes between north and south-facing slopes on Green Mountain near Denver, Colorado*. United States Geological Survey, Department of the Interior, Water-resources investigations report 89-4094.
- Budetta, P., 2004. Assessment of rockfall risk along roads: *Natural Hazards and Earth System Sciences*, Vol. 4, no. 1, pp. 71-81.
- CDOT, 1997. Rockfall rating field worksheet: Staff Construction and Materials Branch.
- CDOT, 2006. Colorado Dept. of Transportation website: Traffic Data: http://www.dot.state.co.us/App_DTD_DataAccess/Traffic/index.cfm?fuseaction=TrafficMain&MenuType=Traffic, accessed August, 2006.
- CDOT, 2006. State wide crashes data base, 1976 to 2004, Traffic Safety Office.
- Corte, A.E., 1966. Particle sorting by repeated freezing and thawing: *Biutetyn Pertglacjalny*, Vol. 15, pp. 175-240.
- Delorme, 2002, Colorado Atlas and Gazetteer 7th Edition, Delorme Mapping Company.
- Dillon, W.R. & Goldstein, M., 1984. *Multivariate Analysis: Methods and Applications*, John Wiley & Sons, NY, pp. 302-336.
- Easterbrook, D.J., 1999. *Surface Processes and Landforms, 2nd Edition*, Prentice Hall Inc., NJ, pp. 402-403.
- Elliasen, T.D. & Ingraham, P.C., 2000. Review, rockfall hazard rating and repair of aging interstate rock cuts in northeastern Vermont: *51st Annual Highway Geology Symposium Proceedings*, Seattle Washington, pp. 233-243.
- Fish, M., and Lane, R., 2001. GIS and the New Hampshire Rock Cut Inventory: *81st Transportation Research Board Annual Meeting, National Research Council, Washington D.C.*
- Flatland, R., 1993. *Application of the Rockfall Hazard Rating System to the rock slopes adjacent to U.S. 50 and State Route 28 on the east side of Lake Tahoe, Nevada*. University of Nevada, Reno, M.S. Thesis, unpublished, 318 p.

- Hadjin, D., 2002. New York State rock slope rating procedure and rockfall assessment: *Transportation Research Record 1786*, paper no. 02-3978, pp. 60-68.
- Hosmer, D.W., & Lemeshow, S., 2000. *Applied Logistic Regression 2nd Edition*, John Wiley & Sons Inc., NY, pp. 260-308.
- Lienhart, D.A., 1988. The geographic distribution of intensity and frequency of freeze-thaw cycles: *Bulletin of the Association of Engineering Geologists*, Vol. XXV, no. 5, pp. 465-469.
- Lowell, S., and Morin, P., 2000. Unstable slope management, Washington State: *Transportation Research News*, no. 207, pp. 11-15.
- Maerz, N.H.; Youssef, A.; Fennessey, T.W.; 2005. New risk-consequence rockfall hazard rating system for Missouri highways using digital image analysis: *Environmental & Engineering Geoscience*, Vol. XI, no. 3, pp. 229-249.
- Mazzoccola, D.F. & Hudson, J.A., 1996. A comprehensive method of rock mass characterization for indicating natural slope instability: *Quarterly Journal of Engineering Geology*, Vol. 29, pp. 37-56.
- McCullagh, P. & Nelder J.A., 1992. *Generalized Linear Model*, Chapman & Hall.
- Miller, S.M., 2003. *Development and implementation of the Idaho Highway Slope Instability and Management System (HiSIMS)*. Idaho Transportation Department, report # N03-07.
- Minitab® Release 14 Statistical Software: Help File: Ordinal Logistic Regression.
- Moore, H.L., 1986. Wedge failures along Tennessee highways in the Appalachian Region: Their occurrence and correction: *Bulletin of the Association of Engineering Geologists*, Vol. 23, no. 4, pp. 441-460.
- New York State Dept. of Transportation, 1996. *Rock slope rating procedure*. Geotechnical Engineering Bureau, report # GEM-15.
- New York Dept. of Transportation, 2003. Geotechnical design procedure for preparing rock slope recommendations: *Geotechnical Design Procedure GDP-13*, Geotechnical Engineering Bureau.

- Nichol, M.R. & Waters, R.J., 1983. Comparison and effectiveness of rockfall mitigation techniques applied by states in the U.S.A. and Canada: *Proceedings of the 20th Annual Engineering Geology and Soils Engineering Symposium, Boise, Idaho.*
- Ortiz, T., 2006. Personal conversation regarding the “Exposure” rating in the current Colorado RHRS.
- Pack, R.T. and Boie K., 2002. Utah rockfall hazards inventory, phase I: *Research Division of Utah Department of Transportation, report # UT-03.01.*
- Patton, F.D. & Deere, D.U., 1970. Significant geologic factors in rock slope stability, in: Van Rensburg, P.W.J., *Planning Open Pit Mines: Proceedings of the Symposium on the Theoretical Background to the Planning of Open Pit Mines with Special Reference to Slope Stability*, A.A. Balkema, Cape Town, Amsterdam, pp. 265-274.
- Pierson, L.A., 1991. The Rockfall Hazard Rating System: *National Symposium on Highway and Railroad Slope Maintenance, 34th Annual Meeting of the Association of Engineering Geologists*, pp. 1-21.
- Pierson, L.A., and Van Vickle, R., 1993. *Rockfall Hazard Rating System Participant’s Manual*: Federal Highway Administration Publication SA-93-057, 104 p.
- Piteau, D.R., 1970. Geologic factors significant to the stability of slopes cut in rock, in: Van Rensburg, P.W.J., *Planning Open Pit Mines: Proceedings of the Symposium on the Theoretical Background to the Planning of Open Pit Mines with Special Reference to Slope Stability*, A.A. Balkema, Cape Town, Amsterdam, pp. 33-53.
- Ritchie, A.M., 1963. Evaluation of rockfall and its control: *Highway Research Board Record*, no. 17, Washington D.C., pp. 13-28
- Romana, M., 1988. Practice of Slope Mass Rating (SMR) classification for slope appraisal: *Glissements de Terrain*, pp. 1227-1229.
- Santi, P.M., 2006. Field methods for characterizing weak rock for engineering: *Environmental and Engineering Geoscience*, Vol XII, no. 1, pp. 1-11.
- Senior, S.A., 1999. Rockfall hazard remediation along Ontario highways: *50th Annual Highway Geology Symposium, Proceedings and Field Trip Guide*, pp. 276-286.

- Shakoor, A., 2005. Development of a rockfall hazard rating matrix for the state of Ohio: *The Ohio Department of Transportation Office of Research & Development Executive Summary Report*.
- Stover, B.K., 1992. *Highway Rockfall Research Report*: Colorado Geological Survey, Special Publication 37, 27 p.
- Szwilski, A.B., 2002. Rockfall rating evaluation and data management systems for highway and railway rock slopes: *Appalachian Transportation Institute and West Virginia Department of Transportation*.
- Vandewater, C.J.; Dunne, W.M.; Mauldon, M.; Drumm, E.C.; Batemann, V.; 2005. Classifying and assessing the geologic contribution to rockfall hazard: *Environmental & Engineering Geoscience*, Vol XI, no. 2, pp. 141-154.
- Watters, R.J., 1998. Modification to the Rockfall Hazard Rating System for successful mitigation in mountainous terrain as a result of climate and slope aspect considerations: *Association of Engineering Geologists 41st Annual Meeting, Programs with Abstracts* Vol. 41, p. 134.
- Western Regional Climate Center website, 2006. <http://www.wrcc.dri.edu/>
Accessed June of 2006.
- Witteman, T.A.; LaMaskin, T.A.; Watts, C.F.; 1992. Examples of the application of the rockfall hazard rating system to Virginia highways: *Virginia Journal of Science*, Vol. 43, no. 2, p. 266.
- Wyllie, D.C., 1987. Rock slope inventory: *Proceedings, Federal Highway Administration Rockfall Mitigation Seminar*, FHWA Region 10, Portland Oregon, 25 p.

APPENDIX A

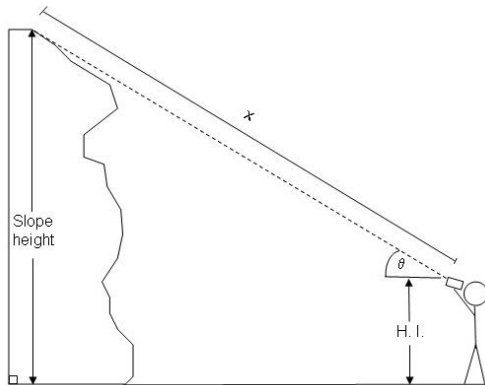
Slope height:

Methodology to determine slope height.

$$\text{Slope Height} = \text{H. I.} + X \sin \theta$$

H. I. = Height of the instrument.
 X = Reading from the range finder.
 θ = Angle read from the slope indicator.

Slope angle:

Consequence rating from rockfall as a function of slope angle and corresponding average slope angle scores (modified from Maerz et al., 2005).

Launching features criteria and example photos:

None: Indicates a relatively smooth slope, with little or no topographic variation along the slope profile. These slopes receive 3 points.



Examples of slopes with no launching features present (score of 3).

Minor: Indicates a slope profile that has small topographic / material variations that could cause launching of boulders, such as the presence of small ridges extending < 2 feet from the slope surface, or occasional boulders on the surface. These slopes receive 9 points.



Examples of slopes with minor launching features present (score of 9).

Many: Indicates a slope profile with several topographic / material variations that could cause launching of boulders, such as the presence of ridges or benches extending from 2-6 feet from the slope surface. These slopes receive 27 points.



Examples of slopes with many launching features present (score of 27).

Major: Indicates a highly irregular slope profile with large rock outcrops, or the presence of large ridges or benches extending more than 6 feet from the slope surface.

These slopes receive 81 points.

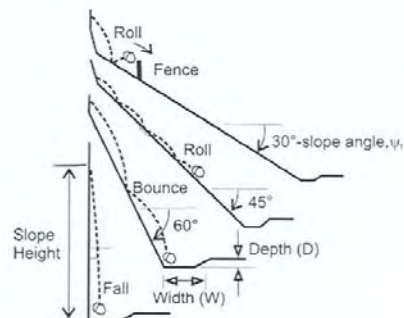
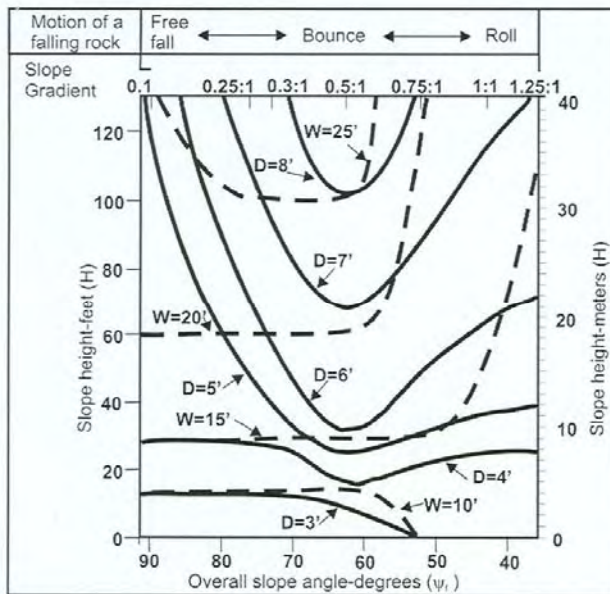

Examples of slopes with major launching features present (score of 81).

Ditch catchment:

Ritchie (1963), ditch design criteria, illustrating suitable ditch width and depth for various slope angles and heights.

$$\text{Ditch Dimension Effectiveness} = \frac{(D_a + W_a)}{(D_r + W_r)} \times 100\%$$

D_a = Actual depth of the ditch.

W_a = Actual width of the ditch.

D_r = Ritchie design depth based on slope height and angle from above figure.

W_r = Ritchie design width based on slope height and angle from above figure.

Scores for actual ditch dimensions vs. required ditch dimensions

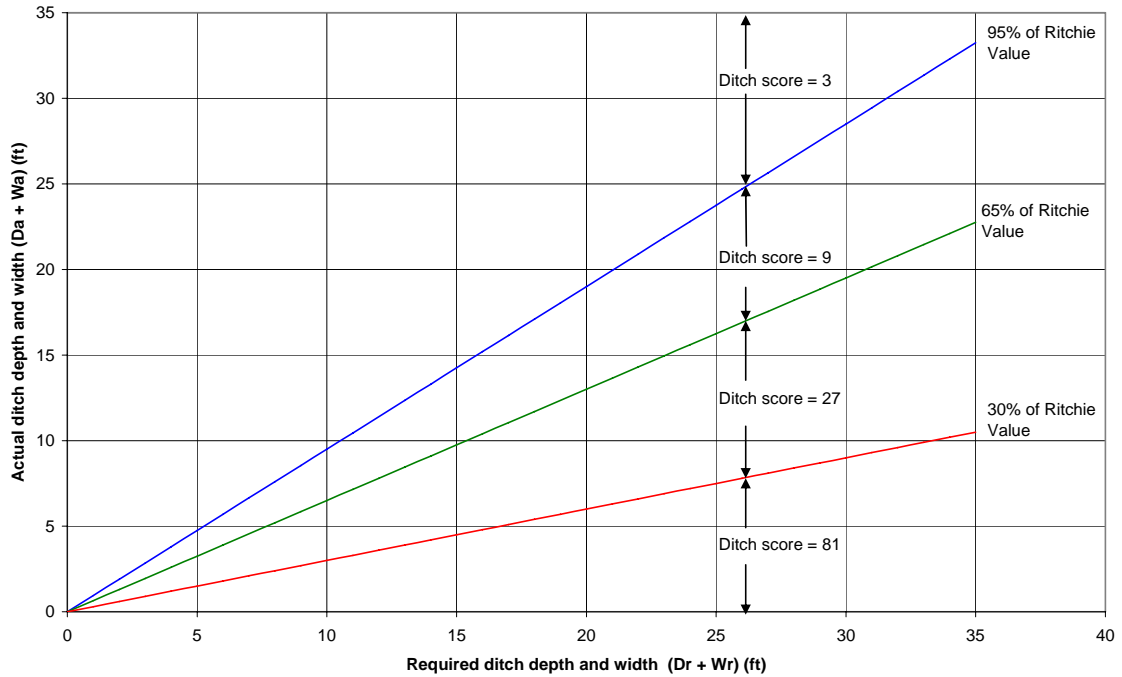

Actual vs. required ditch dimensions and corresponding scores

Ditch Shape Effectiveness				
	Class 1 (score 3)	Class 2 (score 9)	Class 3 (score 27)	Class 4 (score 81)
Off-shoulder slope	> 30° or presence of any barrier	21° - 30°	11° - 20°	0° - 10°

Both the ditch dimension effectiveness and ditch shape effectiveness are rated. The condition that receives the higher score is used to score the ditch catchment.

Annual precipitation:

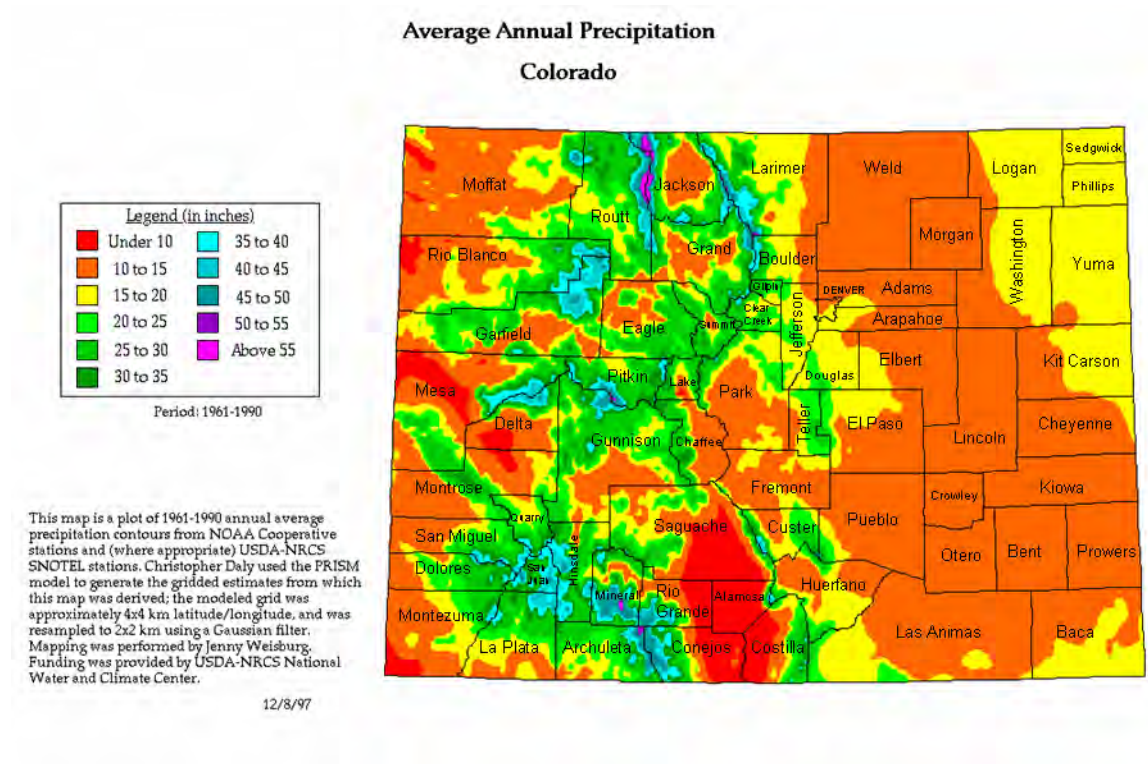

Colorado's average annual precipitation from 1961 to 1990 used to score the annual precipitation parameter. Map was obtained from Western Regional Climate Center (2006).

Annual freeze thaw cycles:

Average Annual Freeze - Thaw Cycle Distribution for Colorado

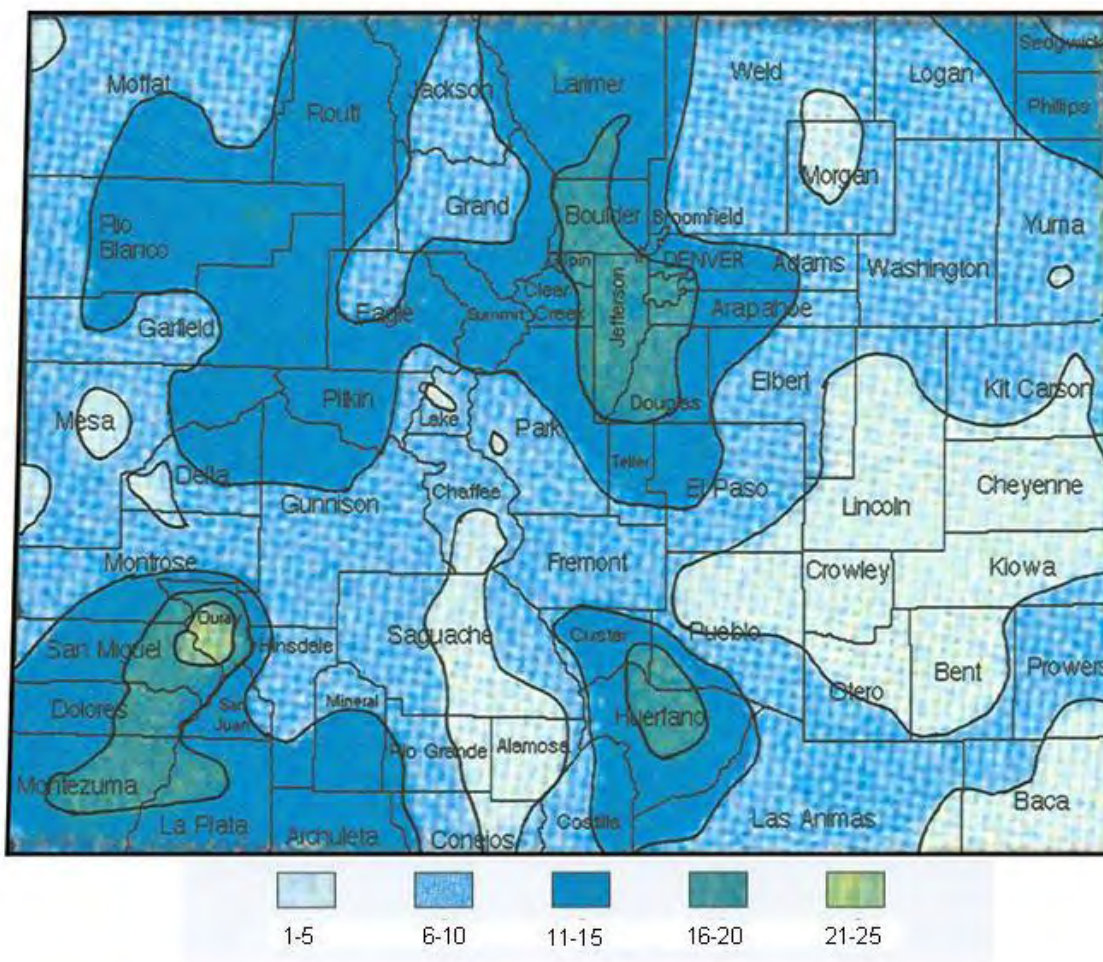

Colorado's average annual freeze / thaw cycle distribution used to score the annual freeze / thaw cycle parameter. Map was modified from Arnold et al. (1996).

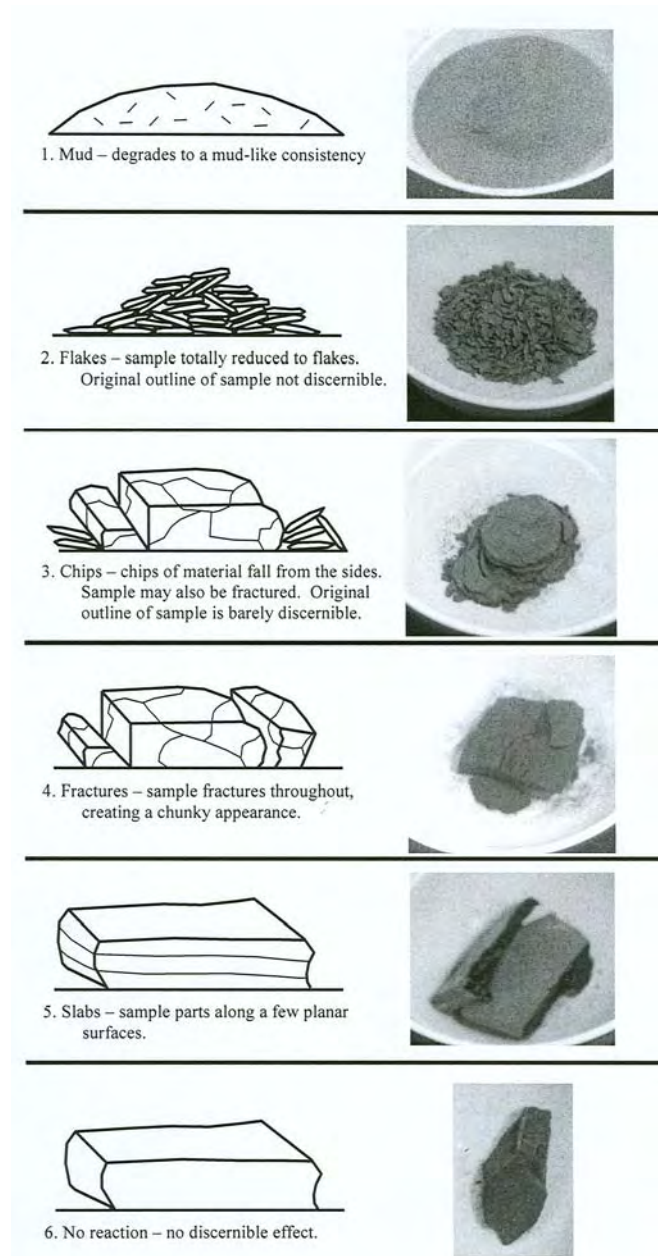
Jar slake:

Various reactions to jar slake tests and corresponding ratings. Figure obtained from Santi (2006).

Sight distance:

$$\frac{\text{Actual Decision Sight Distance}}{\text{Required Decision Sight Distance}} \times 100\%$$

Posted Speed Limit (mph)	Decision Sight Distance (ft)
25	375
30	450
35	525
40	600
45	675
50	750
55	875
60	1,000
65	1,050

Required decision sight distance based on posted speed limits (Pierson and Van Vickle, 1993).

Average vehicle risk (AVR):

$$\text{AVR} = 100 \times \frac{[\text{ADT (cars per day)} \times \text{Slope Length (miles)}] / 24 \text{ (hours per day)}}{\text{Posted Speed Limit (miles per hour)}}$$

Colorado Rockfall Hazard Rating Field Worksheet

Sight Information		SEGMENT ID NUMBER	ENGINEERING REGION	MAINTENANCE SECTION	DATE
ROUTE NO.		BEGIN MILE POST	END MILE POST	R.T. OF CENTERLINE	RATER
COUNTY					
Actual Values		Remarks			
Slope Height	Ditch Depth	Major rockside potential			
Slope Angle	Sight Distance	Dominating rockfall mode: Block-in-matrix / Sedimentary rock / Crystalline rock			
Ditch Slope	Speed Limit	Dominating sight distance: Horizontal / Vertical			
Ditch Width	ADT	Mitigation effectiveness: A B C D F			
Rating		Rating			
Cut Slope / Total Slope (Circle one)		3 Points		9 Points	
Slope Height		25 to 50 ft	50 to 75 ft	75 to 100 ft	> 100 ft
Rockfall Frequency		> 2 years	1 to 2 years	Yearly, seasonal	Year round / severe events
Average Slope Angle Score		0 to 2	2 to 4	4 to 8	> 8
Launching Features		None (smooth slope)	Minor (< 2 ft. surface variation)	Many (2 to 6 ft. surface variation)	Major (> 6 ft. surface variation)
Ditch Catchment		95% to 100% / Class 1	65% to 94% / Class 2	30% to 64% / Class 3	< 30% / Class 4 / > Major launching features
Annual Precipitation		< 10 inches	10 to 20 inches	20 to 35 inches	> 35 inches
Annual Freeze Thaw Cycles		1 to 5	6 to 10	11 to 15	16 or more
Seepage / Water		Dry	Damp / wet	Dripping	Running water
Slope Aspect		N	E, W, NE, NW	SE, SW	S
Degree of Under-Cutting		0 to 1 ft	1 to 2 ft	2 to 4 ft	> 4 ft
Jar Stake		6	5	3 to 4	1 to 2
Degree of Interbedding		1 to 2 weak interbeds, < 6 in.	1 to 2 weak interbeds, > 6 in.	> 2 weak interbeds, < 6 in.	> 2 weak interbeds, > 6 in.
Rock Character		Homogenous / massive	Small faults / strong veins	Schist / shear zones < 6 in.	Weak pegmatite / micas / shear zones > 6 in.
Crys. Rock		0 to 1 ft	1 to 2 ft	2 to 4 ft	> 4 ft
Weathering Grade		Fresh	Surface staining	Slightly altered / softened	Core stones
Block Size / Volume		< 1 ft / < 1 cy	1 to 2 ft / 1 to 3 cy	2 to 5 ft / 3 to 10 cy	> 5 ft / > 10 cy
Number of Sets		1	1 plus random	2	> 2
Persistence, Orientation		< 10 ft and dips into slope	> 10 ft and dips into slope	< 10 ft and daylight out of slope	> 10 ft and daylight out of slope
Aperture		Closed	0.1 to 1 mm	1 to 5 mm	> 5 mm
Weathering Condition		Fresh	Surface staining	Granular infilling	Clay infilling
Friction		Rough	Undulating	Planar	Slickensided
Block Size (x3)		< 1 ft	1 to 2 ft	2 to 5 ft	> 5 ft
Block Shape (x3)		Tabular	Blocky	Blocky to angular	Rounded and smooth
Vegetation (x3)		Fully vegetated	Patchy vegetation	Isolated plants	None
Total Hazard Score:					
Sight Distance		> 80 %	60 % to 80 %	40 % to 60 %	< 40 %
Avg. Vehicle Risk		0 to 24%	25 to 49%	50 to 74%	75% or more
No. of Accidents		0 to 2	3 to 5	6 to 8	9 and over
Total Risk Score:					

Additional Rater's Comments: