

I-70 Mountain Corridor ALIVE Committee Linkage Interference Zones Updates Since July 17, 2008 Alive Meeting

Linkage Interference Zones

Ecological Context of Linkage Interference Zones

The context of the linkage interference zones (LIZs) is the interaction between I-70 and wildlife movement patterns along the Corridor and habitat linkages within the Southern Rocky Mountains in Colorado. This is a key component of the Programmatic Environmental Impact Statement (PEIS), US Fish and Wildlife Service (USFWS) Biological Assessment (BA), and US Forest Service (USFS) Biological Report (BR) for the I-70 Mountain Corridor, and the focus of the ALIVE Committee Memorandum of Understanding (MOU).

The Draft PEIS discussed the vegetation and principal wildlife species and habitats within the Corridor. From an ecological standpoint, the Corridor presents several complex issues for transportation planning and impact assessment. I-70 passes through numerous “life zones” in Colorado, from foothills to alpine. Therefore, project alternatives may affect a wide variety of ecological resources, including, but not limited to, unique and rare plant communities, wildlife migration patterns, wildlife habitats including summer and winter ranges, and aquatic resources. Impacts on wildlife habitats and movement patterns were evaluated based on the anticipated effects of construction, operation, and maintenance of alternatives. Interference with wildlife movement due to the barrier effects created by I-70 and the influences of alternatives is considered to be one of the most serious issues affecting wildlife in the Corridor (see Draft PEIS, Volume II, Resource Maps 3.2-3 Elk Ranges, 3.2-4 Mule Deer Ranges, and 3.2-5 Bighorn Sheep Ranges). LIZs were identified along the Corridor where the barrier effects of I-70 impede traditional wildlife movement or habitat linkage areas. Wildlife linkages connect important components of a species’ habitat needed to complete lifecycles. Effects of winter maintenance and noise on habitats were evaluated within the I-70 “road effect zone.”

The purpose of the Tier 1 BA is to determine to what extent the Preferred Alternative may affect Threatened, Endangered, or Candidate species. This assessment is prepared in accordance with legal requirements set forth under Section 7 of the Endangered Species Act (ESA) (16 USC 1536 (c)) and follows guidance described within the Federal Highway Administration (FHWA) memorandum titled “Management of the Endangered Species Act (ESA) Environmental Analysis and Consultation Process,” dated February 20, 2002. Future formal consultations for listed species may be required for Tier 2 National Environmental Policy Act (NEPA) projects conducted on specific segments of the I-70 Mountain Corridor. The BA will address the effects of the proposed action on Threatened, Endangered, or Candidate species.

The purpose of the BR is to determine the likely effects of the alternatives on federally listed species (endangered, threatened, and proposed), USFS-sensitive species, management indicator species (MIS), and other species or habitats potentially affected by the project alternatives at a Tier 1 level of detail. This is in accordance with direction in the 1997 revision of the *Land and Resource Management Plan for Arapaho and Roosevelt National Forests and Pawnee National Grassland* and the 2002 revision of the *White River National Forest Land and Resource Management Plan* (Forest Plans).

The ALIVE MOU recognizes that the existing I-70 Corridor and the proposed future improvements pass through several life zones and ecosystems that support numerous aquatic and terrestrial wildlife species. It acknowledges that the I-70 Corridor fragments or isolates existing habitats, interferes with free movement of animals within their habitat, and reduces remaining wildlife habitat quality by making such habitat less accessible to many native species. In addition, high-traffic volumes form a difficult-to-penetrate barrier to movement, often resulting in animal-vehicle collisions (AVCs) and serious levels of mortality for some rare or low-density species. Therefore, over time, the benefits derived from a transportation system can come at a cost to other resources, including interference with the ability of wildlife to use the landscape in a manner that maintains population effectiveness.

The ALIVE Committee identified 13 high-priority locations (LIZs) where evidence suggests that the highway's barrier effect impedes important wildlife migration or movement routes or zones of dispersal. The ALIVE program provides a starting point for, and ensures Agencies' participation in the development of, subsequent Tier 2 site-specific analyses and implementation of long-term impact mitigation measures within the context of a Corridor-long, landscape-based ecosystem approach to Corridor impacts on wildlife needs and conservation measures

Linkage Interference Zone Updates

JFSA has updated the information provided at the July 17 ALIVE Committee meeting related to the screening and establishment of the LIZs. In response to comments, we have updated information on land ownership, I-70 structural barriers, openings, and AVC data. The following summarizes the updated information that has been illustrated on Figures 1 through 5. The purpose of these data is to provide the ALIVE Committee with comprehensive documentation of the factors influencing the locations of the LIZs currently included in the ALIVE MOU.

Updated Land Ownership

Figure 1 includes recent land use – open space changes in Clear Creek County. Land use patterns do not appear to be a consistent indicator of wildlife crossing I-70. For example, AVCs are elevated where there is designated open space (Denver Mountain Park) and no physical barriers (in the Mount Vernon Canyon area of Jefferson County). Conversely, AVCs are elevated in the urbanized and developing Avon area (milepost 164 to milepost 166) where fencing and steep slopes are present.

Updated Barrier Inventory – Roadside and Median Structures, and Steep Slopes

The Committee requested a detailed inventory of I-70 barriers that had been mapped as a part of the initial ALIVE program to better evaluate their influence on wildlife trying to cross I-70. This includes specific types and locations of all road edge and median barriers, and adjacent steep slopes. As these data are not available in the CDOT structure inventories, a windshield survey of the Corridor was conducted in August 2008 to identify and map the specific types of barriers from the east entrance of Glenwood Canyon at milepost 127 to C-470 at milepost 260. This also allowed the mapping of any new barriers, such as new sound walls in the Dillon area.

A spreadsheet of barriers was prepared for the median, eastbound lanes, and westbound lanes and includes wildlife fencing, chain link fencing, guard rails, cable rails, jersey barriers, concrete walls, retaining walls, and noise walls. Mapping of adjacent urbanized areas and steep slopes was also refined. Field spreadsheets were then digitized and the data were plotted and formatted

to create the comprehensive barrier inventory illustrated on Figure 2. A total of seven barrier types are shown. In summary, there is a combination of urban areas and structural barriers along 123 miles, leaving 10 miles of the Corridor and the tunnel segments without some form of barriers. Descriptions of the guard rails, cable rails, jersey barriers, and wildlife fences are provided on Figure 4.

The next step was to identify barriers that are considered significant to wildlife movement. Barriers such as guard rails, cable rails, and jersey barriers are not considered significant for large and medium-sized animals because they can be jumped or crossed under. Small forms of wildlife that cannot climb or jump jersey barriers are prevented from crossing unless gaps are provided between the jersey barriers.

Significant structural barriers to larger wildlife include steep slopes, wildlife fencing, and concrete walls. Urban areas are also considered significant barriers; however, they are treated separately. The three physical barrier types are shown on Figure 3, including a summary of the significant barriers. This analysis shows that where wildlife are crossing the highway, as evidenced by high AVCs, as in the Floyd Hill/Mount Vernon Canyon areas, the wildlife may be crossing in part because there are few barriers (Figure 5 mp 254). The area between mp 253 and 256 has few significant barriers and the highest AVCs in the Corridor. However, there also are elevated AVCs in the Wolcott to Avon area, in spite of the presence of wildlife fencing on both sides of the highway, urban areas, some steep slopes, and an occasional wall. Figure 5, mp 165, is near a designated elk crossing area in the Edwards-Avon area. The area has an AVC of 3 to 6 in spite of a number of barriers present.

Updated Openings Under I-70 – Bridges and Other Significant Structures

Large openings, including bridges, provide existing opportunities for wildlife movement under I-70. CDOT's Log of Structures documents literally thousands of openings under I-70, ranging from 6-inch or smaller diameter pipes to bridges hundreds of feet long. For the purposes of this inventory, significant opportunities for wildlife to cross under I-70 include major structures (such as bridges) with openings greater than 20 feet, and minor structures with openings from 10 to 20 feet (pipes and culverts). A 10-foot opening size was identified as a minimum because of the requirements of large mammals. Medium and smaller-sized wildlife would use smaller openings, but they also would benefit from 10-foot openings. It should be noted that wildlife do not typically seek out an opening under a highway; openings are usually used on an opportunistic basis. If wildlife become acclimated to an opening, they may use it repeatedly. The average distance between openings would indicate that wildlife would benefit if I-70 were more permeable than it currently is.

Updated Animal-Vehicle Collision Data

Five years of Colorado State Patrol (CSP) data (2000–2004) were summarized to provide an extended depiction of AVCs (see Table 1). The CSP data are recorded by mile and the actual AVC number in that mile for each of the five years was combined to create an AVC index (AVC/mi/yr) for that mile. There is an AVC index for virtually every mile of the Corridor (missing 10 plus the tunnel segments). These data are presented as vertical, colored bars on Figure 1, representing indices from 0–3, 3–6, and greater than 6. The largest index was 8.8 in mile 255 in Mount Vernon Canyon. Previous AVC data for just the LIZs showed highly variable and low AVC indices. The CSP data show consistent, low level AVC indices across almost the

entire Corridor. Only 14 miles of the Corridor did not report any AVCs. AVCs greater than 3.0 occur in 13 miles of the Corridor, as shown on Figure 1. The average AVC index was 1.26. This also tends to show that wildlife cross the highway opportunistically.

Table 1

CSP ACCIDENT DATA, 2000-2004
I-70 MM 116-260

	2000	2001	2002	2003	2004	/mile/yr	
116			2			2	0.4
117					1	1	0.2
118		1	3	4	3	11	2.2
119			1	1	1	3	0.6
120			1		2	3	0.6
121	2					2	0.4
122	2					2	0.4
123						0	0
124						0	0
125						0	0
126					1	1	0.2
127						0	0
128	1		1			2	0.4
129	1					1	0.2
130			1	1		2	0.4
131	1				2	3	0.6
132	1	1	1			3	0.6
133						0	0
134	1	1		2	2	6	1.2
135			1			1	0.2
136				1		1	0.2
137				2	2	4	0.8
138			1	1		2	0.4
139	1	1		1	1	4	0.8
140			2		1	3	0.6
141			1	1		2	0.4
142					1	1	0.2
143		1		2		3	0.6
144						0	0
145		3	1	2	1	7	1.4
146	1	3	5	2	2	13	2.6
147			1		3	4	0.8
148		1			2	3	0.6
149						0	0
150				1		1	0.2
151				1		1	0.2
152	1				1	2	0.4
153	3	7	6	2	4	22	4.4
154				4	5	9	1.8
155			3	3	4	10	2
156	1	1	3	6	3	14	2.8
157		8	5	8	7	28	5.6
158	2	1	3	2	2	10	2
159		3	3	4	5	15	3
160	1	2	3	3	4	13	2.6
161	1	2	4		2	9	1.8
162	1	3	3	1	2	10	2

163	1	1	2		4	8	1.6
164		5	10	4	1	20	4
165	4	3	12	13	5	37	7.4
166	2	3	1	5	1	12	2.4
167		1		3	2	6	1.2
168	2		1	1	1	5	1
169		2		1	1	4	0.8
170		3	1	1	3	8	1.6
171	2	3		5		10	2
172		1	1	2	2	6	1.2
173	1		2	2	4	9	1.8
174			2	2	4	8	1.6
175			1	2	1	4	0.8
176	1	1	1	1	4	8	1.6
177	1	1	2	7	1	12	2.4
178	1		1	1	2	5	1
179						0	0
180		3	1		3	7	1.4
181		1	1	2	1	5	1
182	1	2	1	4	3	11	2.2
183	1			1	1	3	0.6
184				1	1	2	0.4
185			1	1		2	0.4
186			2		1	3	0.6
187						0	0
188		1			1	2	0.4
189		3				3	0.6
190	1		2			3	0.6
191		1		2	3	6	1.2
192		2		1	2	5	1
193	2	2	3		3	10	2
194		2	1	1		4	0.8
195	1		3	1	2	7	1.4
196			1	1		2	0.4
197	1			1		2	0.4
198	1		1			2	0.4
199			2	1	1	4	0.8
200						0	0
201					1	1	0.2
202	1	1	3	1	2	8	1.6
203					3	3	0.6
204	2	2		4	2	10	2
205				2		2	0.4
206	1		2		3	6	1.2
207				2		2	0.4
208		2			1	3	0.6
209			1	2		3	0.6
210	1		1			2	0.4
211		1	1	1		3	0.6
212						0	0
213						0	0
214						0	0

215				1		1	0.2
216		1				1	0.2
217	1				1	2	0.4
218		1	1		1	3	0.6
219			1		1	2	0.4
220	1	1	1	1		4	0.8
221	1		2	1	2	6	1.2
222				1	1	2	0.4
223	2		1	1		4	0.8
224		1	1			2	0.4
225						0	0
226				1		1	0.2
227			1	1	1	3	0.6
228	2	2			1	5	1
229	1	3	2			6	1.2
230	1		1		1	3	0.6
231	2	2	1	3	1	9	1.8
232	2	2	2	2	3	11	2.2
233				3	2	5	1
234			2		4	6	1.2
235	1	1		2		4	0.8
236	1		2	2		5	1
237	1	1	2			4	0.8
238		1			2	3	0.6
239				2		2	0.4
240				1		1	0.2
241		1	1	1	1	4	0.8
242	1	2	2		1	6	1.2
243			1	1		2	0.4
244	2			4		6	1.2
245			1			1	0.2
246	2	6	5	4	4	21	4.2
247	2	6	3	7	4	22	4.4
248	3	3	4	6	7	23	4.6
249	3	4	5	5	3	20	4
250	4	3	7	7	10	31	6.2
251	2	1	4	6	6	19	3.8
252	5	1	1	7	1	15	3
253	7	7	7	7	4	32	6.4
254	9	5	7	9	10	40	8
255	4	12	10	11	7	44	8.8
256	1	3		3	2	9	1.8
257		2		2	1	5	1
258			4	2		6	1.2
259	1	2	1	5	2	11	2.2
260		1		1		2	0.4

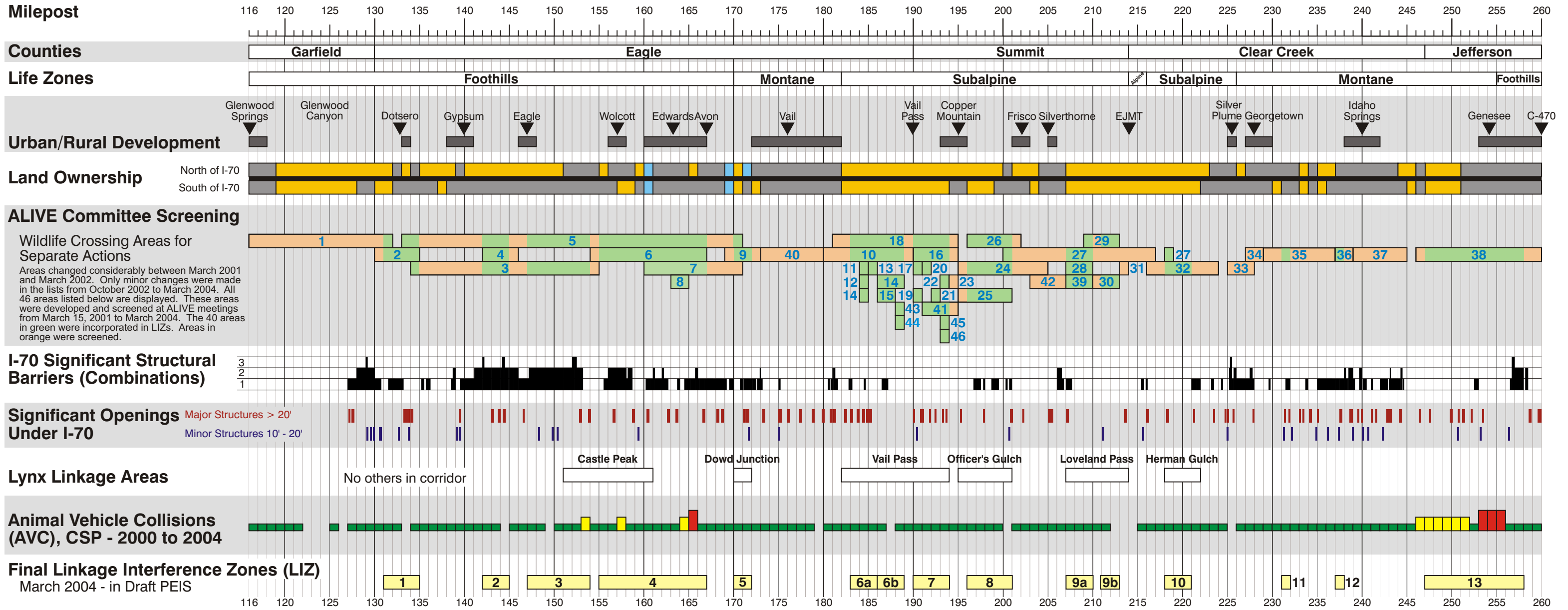

- Key to ALIVE Committee Screening Areas**
- | | | |
|----------------------------|------------------------|-------------------------------------|
| 1 Glenwood Canyon | 9 Dowd Junction | 17 Upper Black Gore Creek |
| 2 Dotsero | 10 West Vail Pass | 18 Vail Pass |
| 3 Dotsero to Gypsum | 11 Timber Creek | 19 Wilder Gulch |
| 4 Eagle Airport | 12 Miller Creek | 20 Corral Creek |
| 5 Eagle Valley | 13 Polk Creek | 21 Stafford Creek |
| 6 Wolcott | 14 Black Gore Creek | 22 Guller Creek |
| 7 Wolcott to Dowd Junction | 15 South of Polk Creek | 23 10-Mile Range to Copper Mountain |
| 8 West of Avon | 16 East Vail Pass | 24 Copper Mountain to Silverthorne |
- Ownership**
- Private Land
 - Public Land
 - State Land
- ALIVE Screening**
- Retained in LIZ
 - Eliminated from LIZ
 - LIZ - Draft PEIS
- AVCs**
- 0 - 3 AVCs
 - 3 - 6 AVCs
 - > 6 AVCs

- Key to Linkage Interference Zones**
- | | | | |
|-------------------------------------|------------------------------|--------------------------------|------------------------------------|
| 17 Upper Black Gore Creek | 25 Owl Canyon/Officers Gulch | 33 Silver Plume | 40 Town of Vail |
| 18 Vail Pass | 26 Officers Gulch | 33 Silver Plume/Georgetown | 41 Wilder Gulch to Copper Mountain |
| 19 Wilder Gulch | 27 Herman Gulch | 34 Georgetown | 42 Frisco-Silverthorne Area |
| 20 Corral Creek | 28 Laskey Gulch | 35 Empire Junction | 43 West of 2nd Black Lake |
| 21 Stafford Creek | 29 Tunnel West | 36 Fall River | 44 Black Lakes |
| 22 Guller Creek | 30 Hamilton Gulch | 37 Idaho Springs to Floyd Hill | 45 No Name 2 Creek |
| 23 10-Mile Range to Copper Mountain | 31 Tunnel | 38 Floyd Hill to Morrison | 46 No Name 1 Creek |
| 24 Copper Mountain to Silverthorne | 32 Tunnel East | 39 Jones Gulch | |

Notes: Portions of 40 out of the 46 wildlife crossing zones (shown in green above) were incorporated into the final LIZs.

Figure 1. Linkage Interference Zones Along I-70

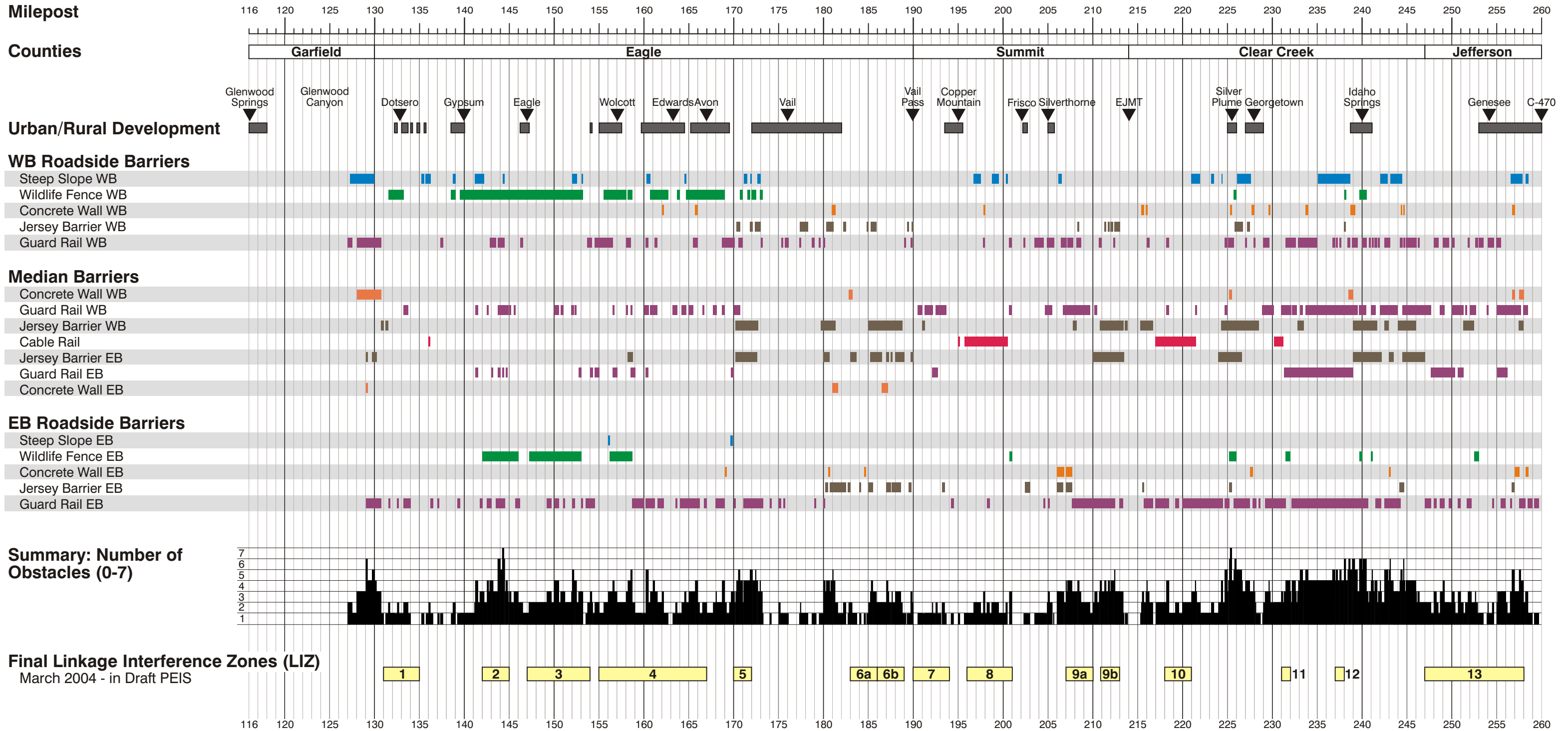
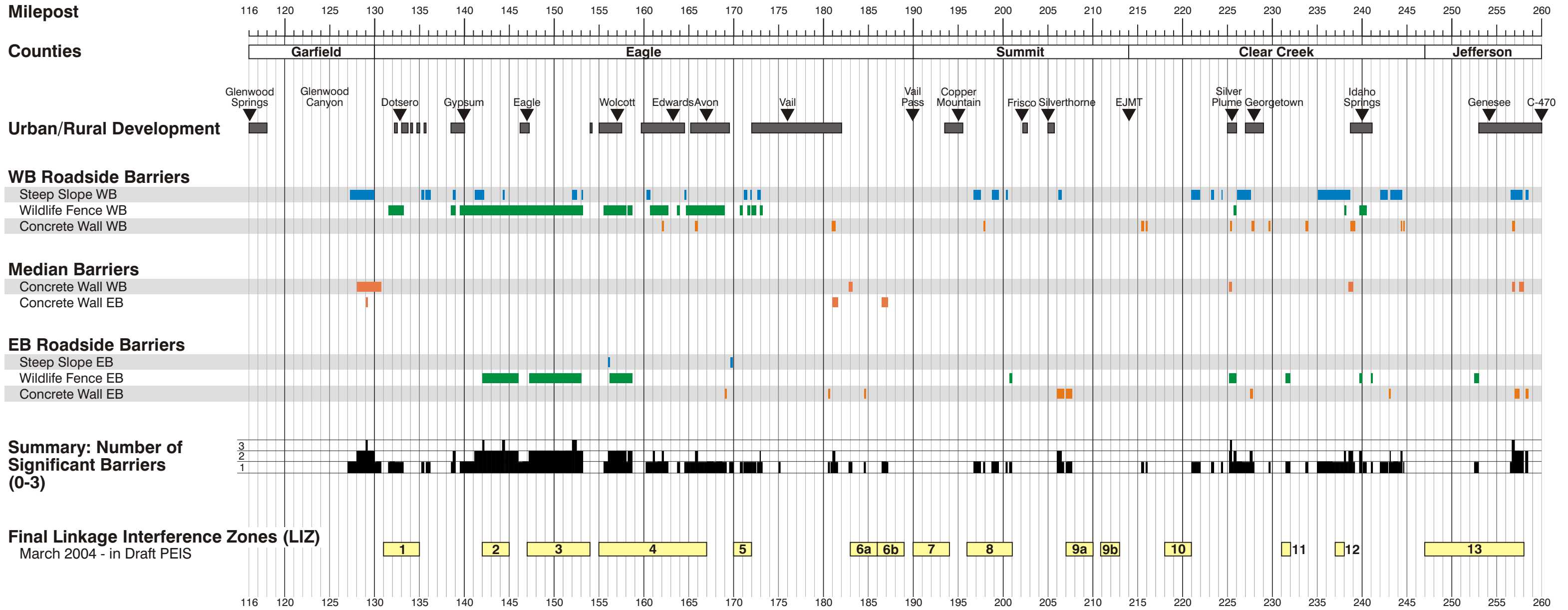
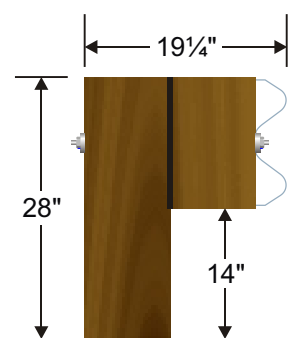
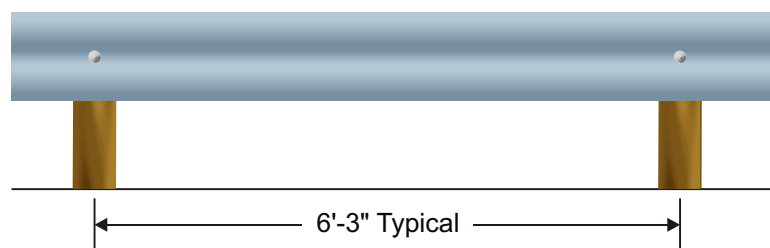

Figure 2. All Barriers Along I-70



Notes: Other types of barriers not shown above are Cable Rail, Guard Rail, and Jersey Barrier (see Figure 2).

Figure 3. Significant Barriers to Wildlife Movement



Guard Rail

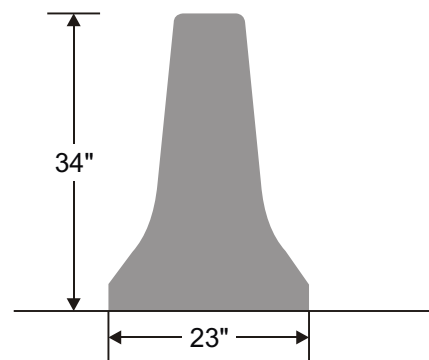

Jersey Barrier

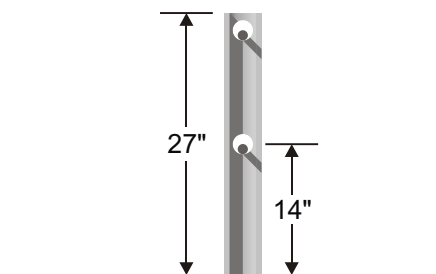

Cable Rail

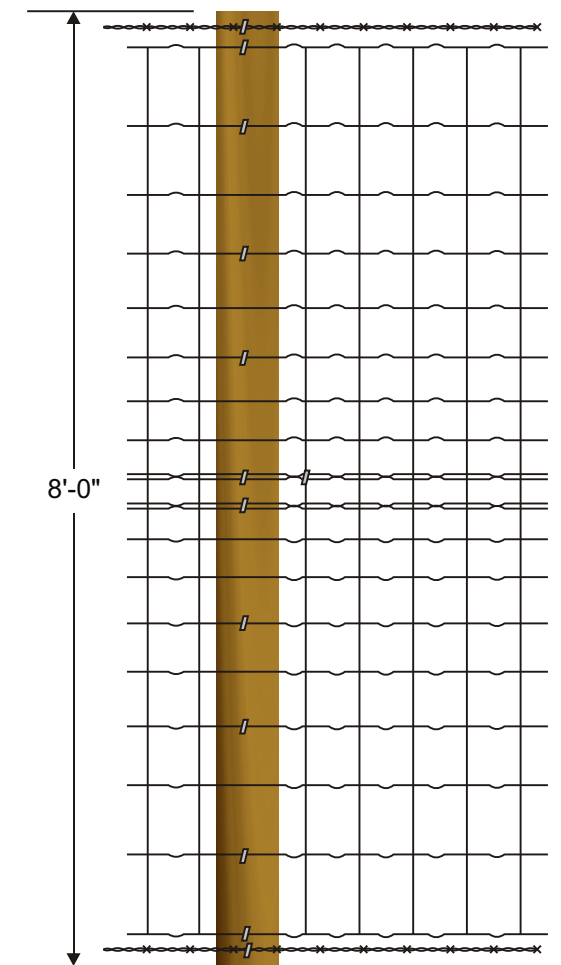

Deer Fence

Figure 4. Types of Barriers



MP 165 westbound, Eagle County

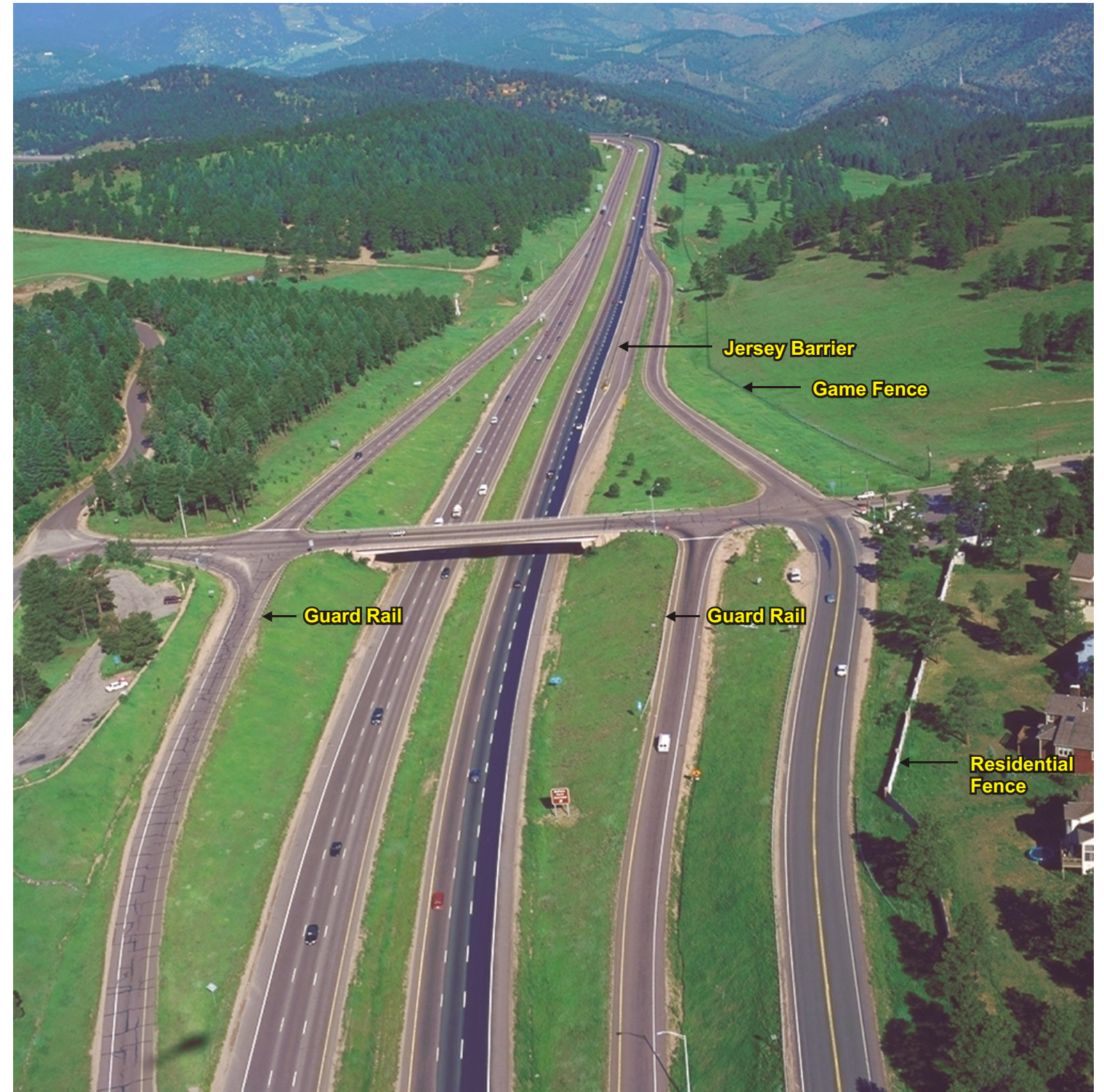

MP 254-253 westbound, Jefferson County Exit 254, Genesee Park.

Figure 5. Representative Wildlife Crossing Area