

*A Path Forward*

*US 6 CLIFTON PUBLIC MEETING*

WELCOME

APRIL 20, 2022



**COLORADO**  
Department of Transportation

# HOW DID WE GET HERE?

## WORK THAT HAS OCCURRED SINCE COMPLETION OF THE PEL STUDY:

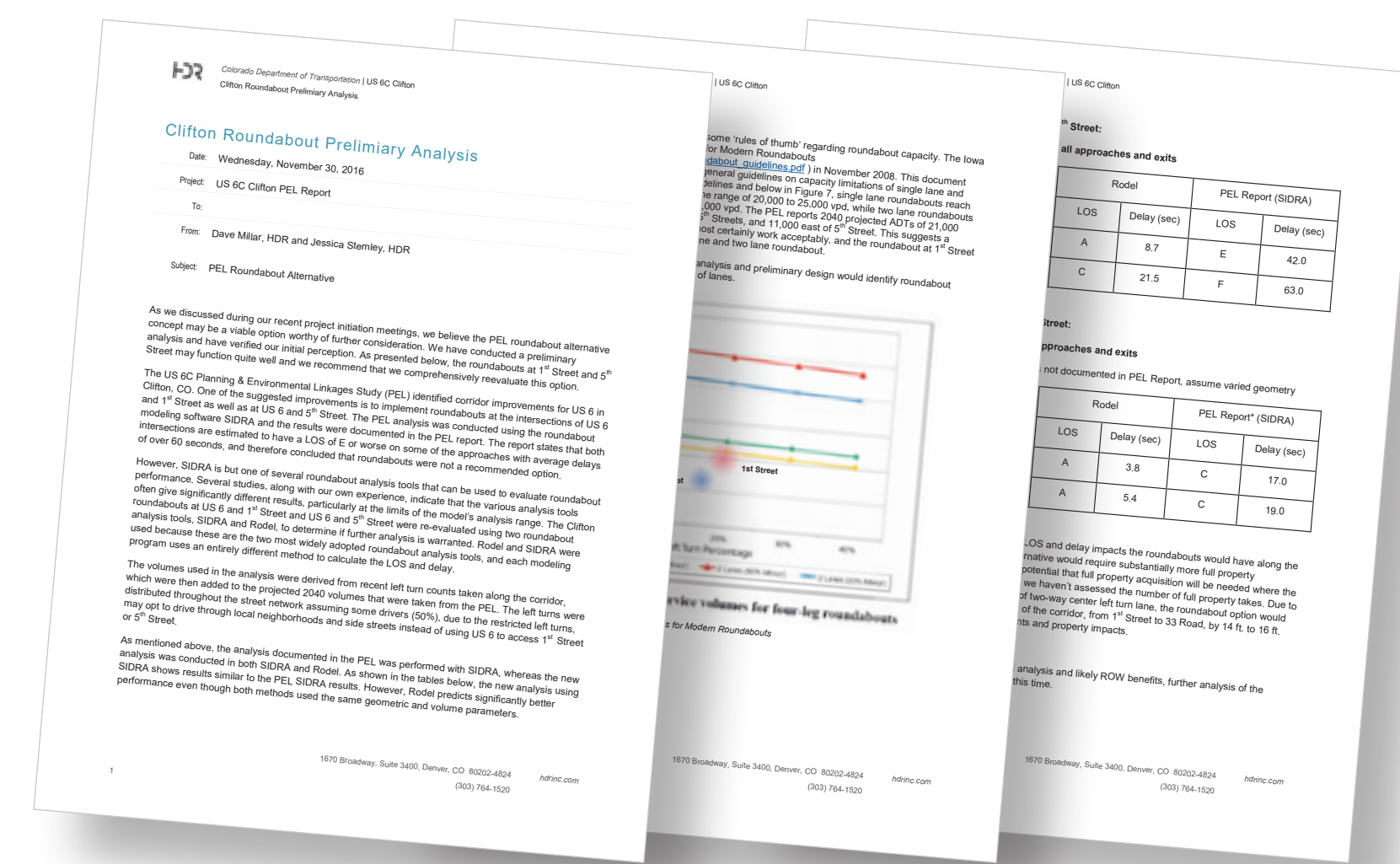

A Traffic Operations and Capacity Analysis was conducted

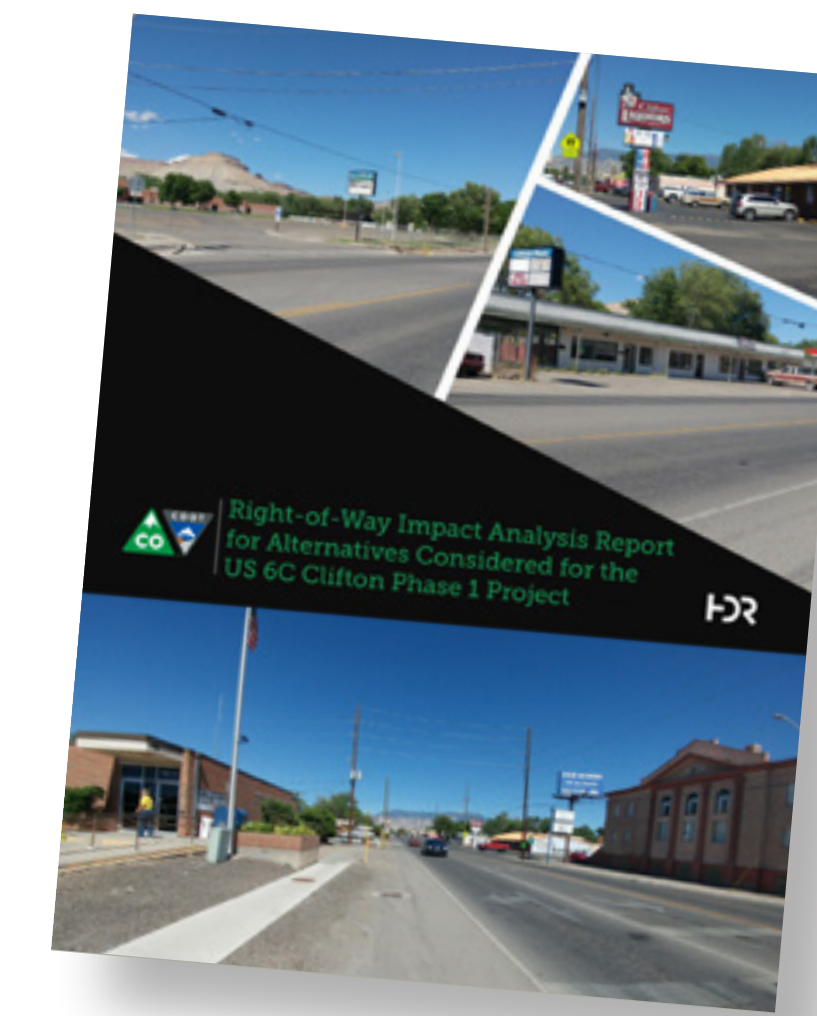

A Right-of-Way Impacts Analysis was completed

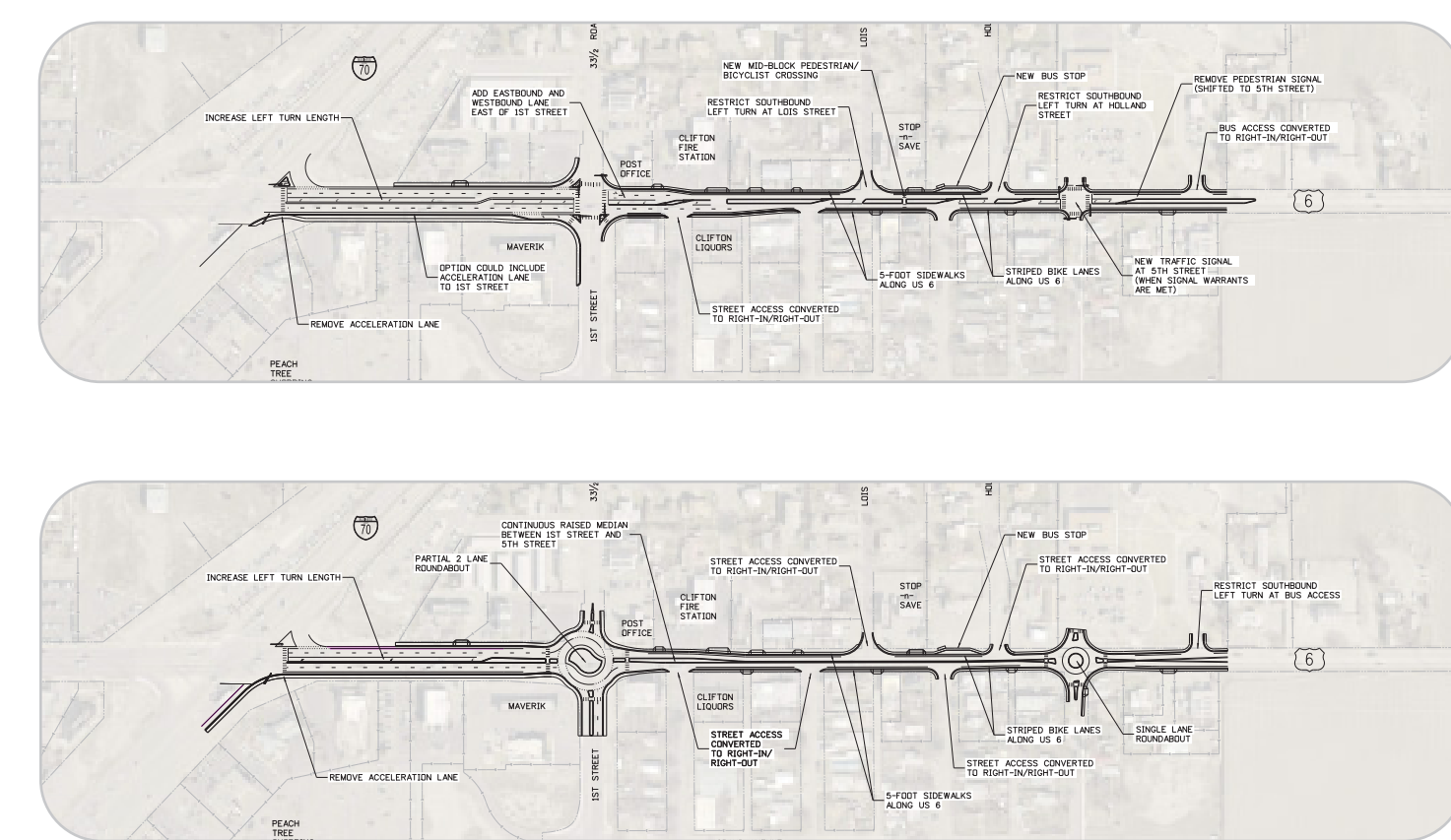

The PEL Recommended Alternatives were re-screened  
The intersection design options – based on the PEL Recommended Alternative – were screened before being presented to the community in October 2021 for factors including but not limited to:

+ Traffic Operations

+ Safety Improvements

+ Right-of-Way Impacts

# PROJECT AREA



# FINAL ROADWAY DESIGN

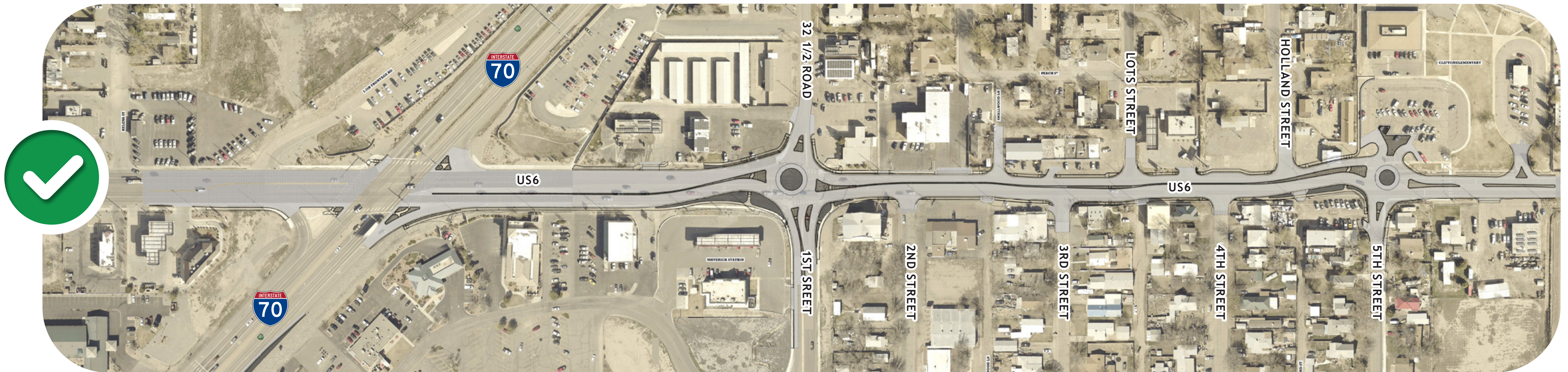

## Example Cross Section

Between 1st Street & 5th Street

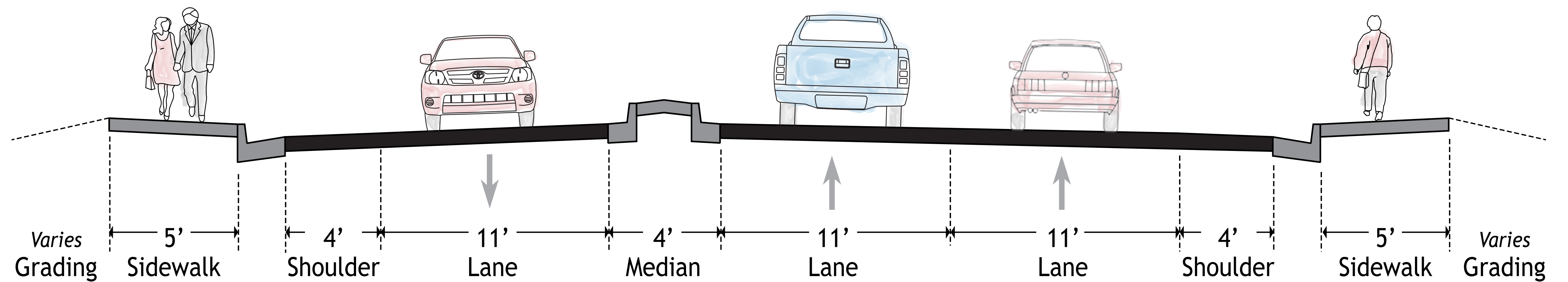

# PROJECT BENEFITS

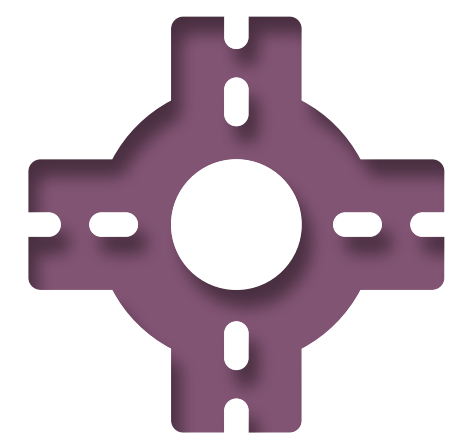

Roundabouts at 1st and 5th Streets to make intersections safer

---



New utility infrastructure throughout project

---



New storm drain system

---



Controlled access to businesses

---



Safety benefits with new sidewalks and lighting

# WHAT'S NEXT?

## US 6 CLIFTON TIMELINE

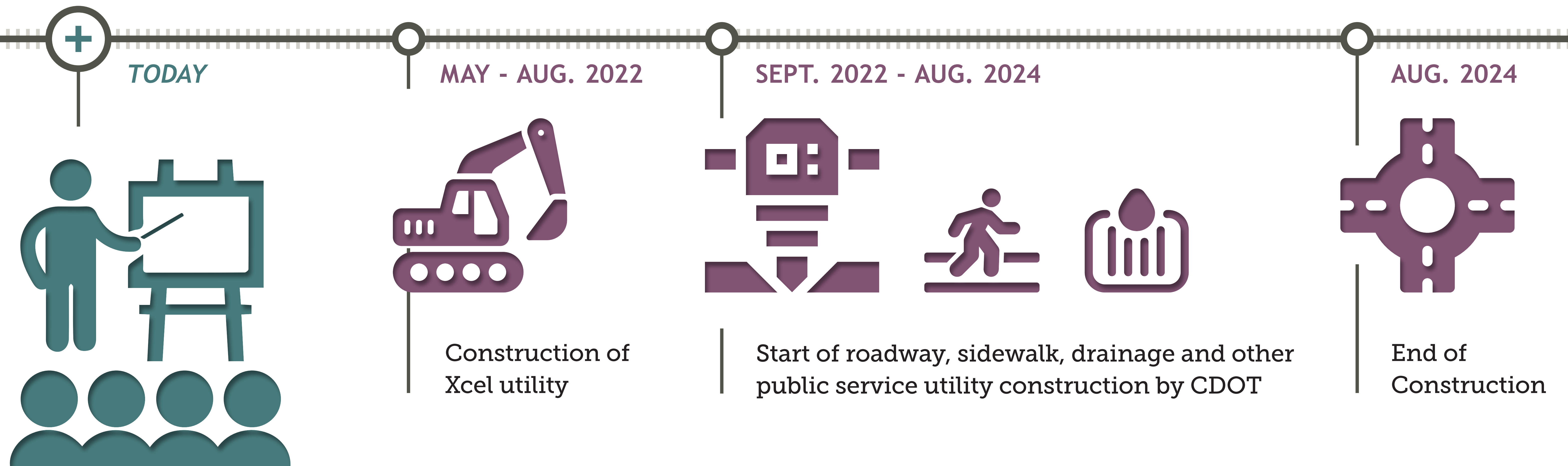

April 20th Public Open House

# WHAT TO EXPECT

We understand construction is tough on our neighbors and drivers, which is why we're doing everything we can to minimize impacts and keep you informed.

## ACTIVITIES YOU MAY ENCOUNTER DURING US 6 CONSTRUCTION



Slow Driving  
Conditions

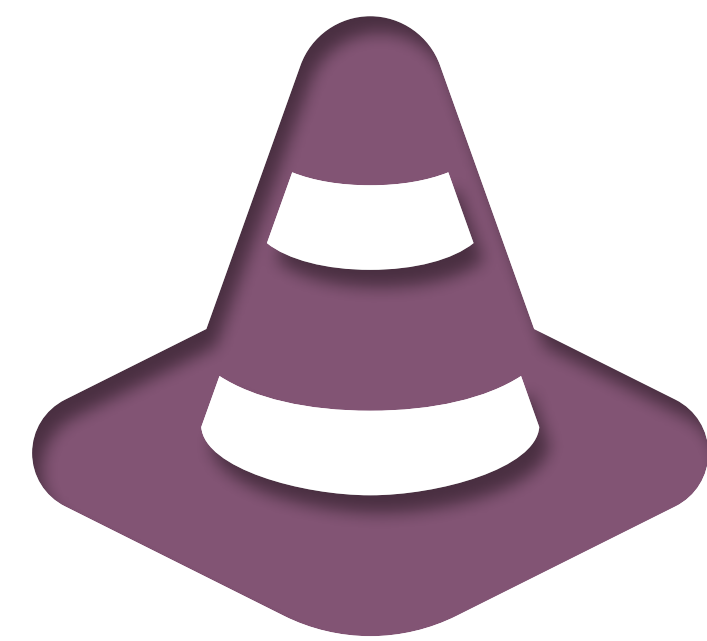

Construction  
Materials



Heavy  
Machinery



Dust, Noise and Vibrations  
Near the Work Area

**THANK YOU FOR YOUR PATIENCE**

Our approach to the project includes keeping US 6 open to traffic, minimizing lane closures as much as possible, and scheduling work during daytime hours

# ALTERNATIVE ROUTE

## US6 WILL REMAIN OPEN DURING CONSTRUCTION

A recommended alternate route to help avoid the primary work area is to take 32 Road to Mesa Ave, then E 1/2 Road to 33 Road.







Learn more, ask questions, and share your feedback  
[codot.gov/projects/us-6-clifton-improvements](https://codot.gov/projects/us-6-clifton-improvements)

**THANK YOU**  
**FOR JOINING US**



**COLORADO**  
Department of Transportation